



MBT-5000A

L-Band Up/Down Converter System Installation and Operation Manual

Part Number MN-MBT-5000A
Revision 1

Firmware Version 1.1.3

IMPORTANT NOTE: The information contained in this document supersedes all previously published information regarding this product. Product specifications are subject to change without prior notice.

Copyright © 2018 Comtech EF Data. All rights reserved. Printed in the USA.
Comtech EF Data, 2114 West 7th Street, Tempe, Arizona 85281 USA, 480.333.2200, FAX: 480.333.2161

Revision History

Rev	Date	Description
0	8-2017	Initial Release.
1	8-2018	Updated formatting and photos.

TABLE OF CONTENTS

PREFACE	I
1.1 Conventions and References.....	i
1.1.1 Patents and Trademarks.....	i
1.1.2 Warnings, Cautions, and Notes	i
1.1.3 Examples of Multi-Hazard Notices.....	ii
1.1.4 Recommended Standard Designations	ii
1.2 Safety and Compliance.....	ii
1.2.1 Electrical Safety and Compliance	ii
1.2.2 Electrical Installation	ii
1.2.3 Operating Environment.....	iii
1.2.4 European Union Radio Equipment and Telecommunications Terminal Equipment (R&TTE) Directive (1999/5/EC) and EN 301 489-1	iii
1.2.4.1 European Union Electromagnetic Compatibility (EMC) Directive (2004/108/EC)	iii
1.2.4.2 European Union Low Voltage Directive (LVD) (2006/95/EC).....	iv
1.2.4.3 European Union RoHS Directive (2002/95/EC)	iv
1.2.4.4 European Union Telecommunications Terminal Equipment Directive (91/263/EEC).....	iv
1.2.4.5 CE Mark	iv
1.3 Product Support.....	iv
1.4 Comtech EF Data Headquarters	v
1.5 Warranty Policy	v
1.5.1 Limitations of Warranty	v
1.5.2 Exclusive Remedies.....	vi
CHAPTER 1. INTRODUCTION.....	1-1
1.1 Overview	1-1
1.2 Functional Description	1-1
1.3 Features	1-3
1.3.1 Block Upconverter (BUC-5000A).....	1-3
1.3.2 Block Downconverter (BDC-5000A)	1-4
1.4 Summary of Specifications	1-5
1.4.1 Physical & Environmental	1-5
1.4.2 Prime Power	1-5
1.4.3 Monitor & Control.....	1-5
1.4.4 Reference	1-6
1.4.5 BUC-5000A Block Upconverters.....	1-6
1.4.6 BDC-5000A Block Downconverters	1-8
1.5 Dimensional Envelope.....	1-9
CHAPTER 2. INSTALLATION	2-1
2.1 Unpack and Inspect the Shipment	2-1
2.2 Install the Unit Into a Rack Enclosure.....	2-2
2.2.1 Optional Rear-Mounting Support Brackets Kit Installation	2-4
2.2.2 Install the Optional Bearingless Rack Slide Set	2-5
CHAPTER 3. REAR PANEL CONNECTIONS.....	3-1
3.1 Cabling Connection Types	3-1
3.1.1 Coaxial Cable Connections	3-1
3.1.1.1 Type 'BNC'	3-2
3.1.1.2 Type 'TNC'.....	3-2
3.1.1.3 Type 'N'	3-2
3.1.1.4 Type 'F'	3-3

3.1.1.5	Type 'SMA' (Subminiature Version 'A')	3-3
3.1.2	D-Subminiature Cable Connections	3-3
3.1.3	RJ-45, RJ-48 Cable Connections	3-4
3.2	MBT-5000A Cabling Connections	3-5
3.2.1	IF Connector Group	3-6
3.2.1.1	'J4 IF OUT/IN' (Side B) Connector (Type 'N' Female)	3-6
3.2.1.2	'J5 RF IN/OUT' (Side B) Connector (Type 'N' Female)	3-6
3.2.1.3	'J6 IF OUT/IN' (Side A) Connector (Type 'N' Female)	3-6
3.2.1.4	'J7 RF IN/OUT' (Side A) Connector (Type 'N' Female)	3-6
3.2.2	Optional Redundancy Groups	3-7
3.2.2.1	Optional 'RF' Connectors (Type 'SMA' Female)	3-7
3.2.2.2	Optional 'IF' Connectors (Type 'SMA' Female)	3-7
3.2.3	Utility Connector Group	3-7
3.2.3.1	'J2 EXT REF IN' – External Reference Input Connector (BNC-F)	3-7
3.2.3.2	'J8 EXT REF OUT' – External Reference Output Connector (BNC-F)	3-7
3.2.3.3	'J9 10/100 ETHERNET' 10/100 BaseT M&C Port (RJ-45)	3-8
3.2.3.4	'P1 RELAY' Summary Fault Output Connector (DB-9F)	3-9
3.2.3.5	'J1 COM 1' EIA-485/232 Interface Connector (DB-9F)	3-10
3.3	MBT-5000A Ground and Power Connections	3-12
3.3.1	Chassis Ground Interface	3-12
3.3.2	Alternating Current (AC) Power Interfaces	3-13
3.3.2.1	Standard 90-260V Alternating Current (AC) Power Interface	3-13
3.3.2.1.1	Standard 90-260V AC Operation – Apply Power	3-14
3.3.2.1.2	Standard 90-260V AC Operation – Replace the Fuses	3-15
3.3.2.2	Optional Dual Entry Module Alternating Current (AC) Power Interface (Redundancy Units Only)	3-15
3.3.3	DC Power Interfaces	3-16
3.3.3.1	Optional -48V Direct Current (DC) Power Interface	3-16
3.3.3.1.1	Optional -48V DC Operation – Apply Power	3-17
3.3.3.1.2	Optional -48V DC Operation – Replace the Fuse	3-18
CHAPTER 4.	UPGRADING FIRMWARE	4-1
4.1	Overview	4-1
4.1.1	About Firmware Files Naming, Versions, and Formats	4-1
4.2	Getting Started: Prepare for the Firmware Download	4-3
4.2.1	Download and Extract the Firmware Update	4-7
4.2.2	Perform the Ethernet FTP Upload Procedure	4-9
CHAPTER 5.	FRONT AND REAR PANEL OPERATION	5-1
5.1	Overview	5-1
5.1.1	Switch Power On (Rear Panel)	5-3
5.1.2	LED Indicators	5-3
5.1.3	Keypad	5-4
5.1.4	Vacuum Fluorescent Display (VFD)	5-4
5.1.4.1	Screen Saver	5-5
5.1.4.2	Opening Screen	5-5
5.2	Front Panel Operation	5-6
5.2.1	SELECT: (Main) Menu	5-7
5.2.2	SELECT: Config (Configuration) Menu Branches	5-8
5.2.2.1	CONFIG: Remote (Remote Control) Menus	5-9
5.2.2.1.1	Remote Control: Local	5-9
5.2.2.1.2	Remote Control: Serial	5-9
5.2.2.1.3	Remote Control: Ethernet	5-10
5.2.2.2	CONFIG: FltRec (Fault Recovery) Menu	5-12
5.2.2.3	CONFIG: ConvA or ConvB (Converter 'A' or Converter 'B') Menus	5-12

5.2.2.3.1	Converter X: Mute/Freq	5-12
5.2.2.3.2	Converter X: Attenuation.....	5-13
5.2.2.4	CONFIG: RefAdj (Reference Oscillator Adjustment) Menu	5-13
5.2.2.5	CONFIG: Redun (Redundancy) Menus	5-13
5.2.2.5.1	Redundancy Mode: Disable/Enable	5-13
5.2.2.5.2	Redundancy Mode: Force	5-14
5.2.3	SELECT: Monitor Menu Branch.....	5-15
5.2.3.1	Monitor: Faults.....	5-15
5.2.3.2	Monitor: Mask.....	5-16
5.2.3.2.1	Out-of-Range Power Supply Masking Using the PS Submenu.....	5-16
5.2.3.3	Monitor: Event-Log (Stored Events).....	5-17
5.2.3.3.1	Stored Events: View.....	5-17
5.2.3.3.2	Stored Event: Clear-All	5-18
5.2.3.4	Monitor: LPT (Low Power Threshold)	5-18
5.2.4	SELECT: Info (Information) Menu Branch	5-19
5.2.4.1	INFO: Remote (Remote Control)	5-19
5.2.4.2	INFO: ConvA (Converter 'A') or ConvB (Converter 'B').....	5-20
5.2.4.3	INFO: PS1 or PS2 (Power Supply '1' or Power Supply '2')	5-20
5.2.4.4	INFO: Ref (Reference Oscillator)	5-20
5.2.4.5	INFO: MC (Voltage generated on the M&C)	5-20
5.2.4.6	INFO: EOD (Equipment Odometer)	5-21
5.2.5	SELECT: Utility Menu Branch	5-22
5.2.5.1	UTILITY: Date/Time (Set Real-time Clock)	5-22
5.2.5.2	UTILITY: CID (Circuit ID).....	5-22
5.2.5.3	UTILITY: Display (VFD Display Brightness).....	5-23
5.2.5.4	UTILITY: Firmware	5-23
5.2.5.4.1	Firmware Images: Info	5-23
5.2.5.4.2	Firmware Images: Select.....	5-23
5.2.5.5	UTILITY: LNA	5-24
5.2.5.5.1	LNA: ConvX (ConvA or ConvB).....	5-24
5.2.6	SELECT: Test Menu Branch	5-26
CHAPTER 6. ETHERNET-BASED REMOTE PRODUCT MANAGEMENT.....		6-1
6.1	Overview	6-1
6.2	Ethernet Management Interface Protocols.....	6-2
6.3	SNMP Interface	6-3
6.3.1	Management Information Base (MIB) Files	6-3
6.3.2	SNMP Community Strings	6-4
6.3.3	SNMP Traps.....	6-4
6.4	Telnet Interface	6-5
6.4.1	Telnet Operation via HyperTerminal.....	6-6
6.5	HTTP (Web Server) Interface.....	6-7
6.5.1	Enable the Web Server Interface.....	6-7
6.5.2	User Login.....	6-8
6.5.3	Web Server Interface – Operational Features	6-9
6.5.3.1	Navigation	6-9
6.5.3.2	Page Sections	6-9
6.5.3.3	Action Buttons	6-9
6.5.3.4	Drop-down Lists	6-9
6.5.3.5	Text or Data Entry.....	6-10
6.5.4	Web Server Interface – Menu Tree.....	6-10
6.5.5	Web Server Interface – Page Descriptions.....	6-11
6.5.5.1	Home Pages.....	6-11
6.5.5.1.1	Home Home.....	6-11
6.5.5.1.2	Home Contact	6-12

6.5.5.1.3	Home Support.....	6-13
6.5.5.2	Admin Pages.....	6-14
6.5.5.2.1	Admin Access.....	6-14
6.5.5.2.2	Admin SNMP.....	6-16
6.5.5.3	Config Pages.....	6-17
6.5.5.3.1	Config MBT.....	6-17
6.5.5.3.2	Config Utility.....	6-20
6.5.5.3.3	Config Redundancy.....	6-22
6.5.5.4	Status Pages.....	6-23
6.5.5.4.1	Status Events.....	6-23
6.5.5.4.2	Status Status.....	6-25
6.6	Critical Status.....	6-27
CHAPTER 7.	SERIAL-BASED REMOTE PRODUCT MANAGEMENT.....	7-1
7.1	Overview.....	7-1
7.1.1	EIA-485.....	7-2
7.1.2	EIA-232.....	7-2
7.2	Remote Commands and Queries Overview.....	7-3
7.2.1	Basic Protocol.....	7-3
7.2.2	Packet Structure.....	7-4
7.2.2.1	Start of Packet.....	7-5
7.2.2.2	Target Address.....	7-5
7.2.2.3	Address Delimiter.....	7-5
7.2.2.4	Instruction Code.....	7-6
7.2.2.5	Instruction Code Qualifier.....	7-6
7.2.2.6	Optional Message Arguments.....	7-7
7.2.2.7	End of Packet.....	7-8
7.3	Remote Commands and Queries.....	7-9
7.3.1	MBT-5000A Base Unit Remote Commands and Queries.....	7-11
7.3.2	Block Converter (BUC / BDC) Remote Commands and Queries.....	7-22
APPENDIX A.	BUC-5000X/BDC-5000X MODULE REMOVAL/INSTALLATION.....	A-1
A.1	Overview.....	A-1
A.2	Module Removal Procedure.....	A-3
A.3	Module Installation Procedure.....	A-6
APPENDIX B.	MBT-5000A REDUNDANCY OPERATION.....	B-1
B.1	Overview.....	B-1
B.2	Configuration.....	B-1

LIST OF TABLES

Table 3-1. MBT-5000A Connectors	3-5
Table 3-2. 'J9 10/100 ETHERNET' Connector Pinout.....	3-8
Table 3-3. 'P1 RELAY' Connector Pinout	3-9
Table 3-4. 'J1 COM1' 2-Wire EIA-485 Interface Connector Pinout.....	3-10
Table 3-5. 'J1 COM1' 4-Wire EIA-485 Interface Connector Pinout.....	3-10
Table 3-6. 'J1 COM1' EIA-232 Interface Connector Pinout.....	3-11

LIST OF FIGURES

Figure 1-1. MBT-5000A L-Band Up/Down Converter	1-1
Figure 1-2. MBT-5000A Operational Schematics	1-2
Figure 1-3. MBT-5000A Dimensional Envelope	1-9
Figure 2-1. MBT-5000A Packing/Shipping Diagram	2-1
Figure 2-2. Unit Rack Enclosure Installation.....	2-3
Figure 2-3. Optional Rear-Mounting Support Brackets Kit Installation	2-4
Figure 2-4. Optional Bearingless Rack Slide Installation (FP/SL000X).....	2-6
Figure 3-1. Coaxial Connector Examples	3-1
Figure 3-2. D-Subminiature Connector Examples	3-3
Figure 3-3. MBT-5000A Cabling Connections.....	3-5
Figure 3-4. MBT-5000A Chassis – Common Ground Interface	3-12
Figure 3-5. MBT-5000A Standard AC Power Interface	3-13
Figure 3-6. MBT-5000A AC Power	3-14
Figure 3-7. MBT-5000A AC Fuse Replacement.....	3-15
Figure 3-8. MBT-5000A Optional Dual Entry Module AC Power Interface	3-15
Figure 3-9. MBT-5000A Optional DC Power Interface.....	3-16
Figure 3-10. MBT-5000A DC Power	3-17
Figure 3-11. MBT-5000A DC Fuse Replacement.....	3-18
Figure 5-1. MBT-5000A Front and Rear Panel Views (Redundant Unit Shown)	5-1
Figure 5-2. MBT-5000A Front Panel Menu Tree (Firmware Ver. 1.1.1)	5-6
Figure 6-1. Home Home Page	6-11
Figure 6-2. Home Contact Page	6-12
Figure 6-3. Home Support Page	6-13
Figure 6-2. Admin Access Page	6-14
Figure 6-3. Admin SNMP Page	6-16
Figure 6-4. Config MBT Page	6-17
Figure 6-5. Config Utility Page	6-20
Figure 6-6. Config Redundancy Page.....	6-22
Figure 6-7. Status Events Page	6-23
Figure 6-8. Status Status Page	6-25
Figure 6-9. Critical Status Page	6-27
Figure A-1. BUC-5000x/BDC-5000x Module	A-2
Figure B-1. MBT-5000A Redundancy – Functional Schematics.....	B-2
Figure B-2. MBT-5000A Redundancy Cabling Requirements	B-3

Acronym List

Acronym	Description	First Use Page Number
AFR	Auto Fault Recovery	5-7
AO	Assignment Operator	7-6
BDC	Block Down Converter	1-4
BUC	Block Up Converter	1-3
CEFD	Comtech EF Data	i
EIA	Electronic Industries Association	ii
EMC	Electro Magnetic Compatibility	iii
ERM	Electromagnetic Compatibility and Radio Spectrum Matters	iii
ESD	Electrostatic Discharge	2-2
FTP	File Transfer Protocol	4-1
HTTP	Hypertext Transfer Protocol	3-8
IEC	International Electrotechnical Commission	3-15
LCD	Liquid Crystal Display	5-4
LED	Light Emitting Diode	5-1
LNA	Low Noise Amplifier	1-4
LVD	Low Voltage Directive	iv
M&C	Monitor and Control	1-2
MIB	Management Information Base	6-2
NMS	Network Management System	6-2
OID	Object Identifier	6-2
PC	Personal Computer	3-8
R&TTE	Radio and Telecommunications Terminal Equipment	iii
RS	Recommended Standard	ii
SNMP	Simple Network Management Protocol	3-8
UART	Universal Asynchronous Receiver Transmitter	7-3
UTP	Unshielded Twisted Pair	3-8
VFD	Vacuum Fluorescent Display	5-1

Units of Measurement

Unit / Symbol	Definition
Ω	Ohm
A	Ampere
bps	bits per second
°C	Celsius (degrees)
Hz	Hertz
kHz	kiloHertz
dB	decibel
dBc	Decibels relative to the carrier
dBm	Decibel-milliwatts
°F	Fahrenheit (degrees)
GHz	Gigahertz
Kbps	Kilobit per second
kg	kilogram
ksps	Kilosymbols per second
lbs.	pounds
mA	Milli-amp
Mbps	Megabit per second
MHz	Megahertz
mm	millimeter
ms	millisecond
Mpsps	Megasymbol per second
mW	milliwatt
in.	inch
Pps	Packets per second
μF	100 micro-farads
W	Watt
V	Volt
VAC	Volt Alternating Current
VDC	Volt Direct Current

BLANK PAGE

PREFACE

About this Manual

This manual provides installation and operation information for Comtech EF Data's MBT-5000A L-Band Up/Down Converter System. This document is intended for the persons responsible for the operation and maintenance of the MBT-5000A.

Disclaimer

Comtech EF Data has reviewed this manual thoroughly to provide an easy-to-use guide to this equipment. All statements, technical information, and recommendations in this manual and in any guides or related documents are believed reliable, but the accuracy and completeness thereof are not guaranteed or warranted, and they are not intended to be, nor should they be understood to be, representations or warranties concerning the products described. Further, Comtech EF Data reserves the right to make changes in the specifications of the products described in this manual at any time without notice and without obligation to notify any person of such changes.

If there are any questions regarding this equipment or the information in this manual, please contact Comtech EF Data Product Support.

1.1 Conventions and References

1.1.1 Patents and Trademarks

See all of Comtech EF Data's Patents and Patents Pending at <http://patents.comtechefdata.com>. Comtech EF Data acknowledges that all trademarks are the property of the trademark owners.

1.1.2 Warnings, Cautions, and Notes



A **WARNING** informs you about a possible hazard that **MAY CAUSE DEATH** or **SERIOUS INJURY**.



A **CAUTION** informs you about a possible hazard that **MAY CAUSE INJURY** or **PROPERTY DAMAGE**.



A **NOTE** gives you important information about a task or the equipment.



A **REFERENCE** directs you to additional information about a task or the equipment.

1.1.3 Examples of Multi-Hazard Notices

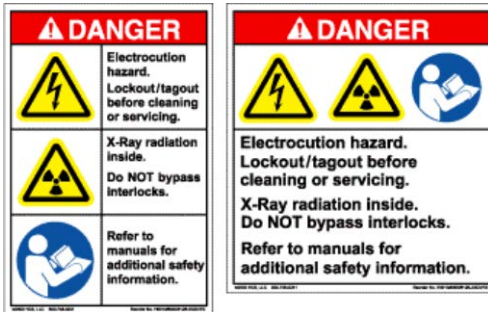

1.1.4 Recommended Standard Designations

The new designation of the Electronic Industries Association (EIA) supersedes the Recommended Standard (RS) designations. References to the old designations may be shown when depicting actual text (e.g., RS-232) displayed on the MBT-5000A Web Server pages or serial remote interface. All other references in the manual refer to EIA designations.



CAUTION – Carefully review the following information:

1.2 Safety and Compliance

1.2.1 Electrical Safety and Compliance

The unit complies with the **EN 60950 Safety of Information Technology Equipment (Including Electrical Business Machines)** safety standard.



CAUTION – IF THE UNIT IS OPERATED IN A VEHICLE OR MOVABLE INSTALLATION, MAKE SURE THE UNIT IS STABLE. OTHERWISE, EN 60950 SAFETY IS NOT GUARANTEED.

1.2.2 Electrical Installation



CAUTION – CONNECT THE UNIT TO A POWER SYSTEM THAT HAS SEPARATE GROUND, LINE, AND NEUTRAL CONDUCTORS. DO NOT CONNECT THE UNIT WITHOUT A DIRECT CONNECTION TO GROUND.



Chapter 3.3 MBT-5000A GROUND AND POWER CONNECTIONS

1.2.3 Operating Environment



CAUTION – DO NOT OPERATE THE UNIT IN ANY OF THESE EXTREME OPERATING CONDITIONS:

- **AMBIENT TEMPERATURES LESS THAN 0° C (32° F) OR MORE THAN 50°C (122°F).**
- **PRECIPITATION, CONDENSATION, OR HUMID ATMOSPHERES OF MORE THAN 95% RELATIVE HUMIDITY.**
- **UNPRESSURIZED ALTITUDES OF MORE THAN 2000 METRES (6561.7 FEET).**
- **EXCESSIVE DUST.**
- **FLAMMABLE GASES.**
- **CORROSIVE OR EXPLOSIVE ATMOSPHERES.**

1.2.4 European Union Radio Equipment and Telecommunications Terminal Equipment (R&TTE) Directive (1999/5/EC) and EN 301 489-1

Independent testing verifies that the unit complies with the European Union R&TTE Directive, its reference to EN 301 489-1 (Electromagnetic compatibility and Radio spectrum Matters [ERM]; ElectroMagnetic Compatibility [EMC] standard for radio equipment and services, Part 1: Common technical requirements), and the Declarations of Conformity for the applicable directives, standards, and practices that follow:

1.2.4.1 European Union Electromagnetic Compatibility (EMC) Directive (2004/108/EC)

- **Emissions: EN 55022 Class B** – Limits and Methods of Measurement of Radio Interference Characteristics of Information Technology Equipment.
- **Immunity: EN 55024** – Information Technology Equipment: Immunity Characteristics, Limits, and Methods of Measurement.
- **EN 61000-3-2** – Harmonic Currents Emission
- **EN 61000-3-3** – Voltage Fluctuations and Flicker.
- **Federal Communications Commission Federal Code of Regulation FCC Part 15, Subpart B.** This equipment complies with the limits for a Class A digital device. These limits are designed to provide reasonable protection against harmful interference when the equipment is operated in a commercial environment.

This equipment generates, uses, and can radiate radio frequency energy. Operation of this equipment in a residential area is likely to cause harmful interference; in which case, users are required to correct the interference at their own expense.







CAUTION – TO ENSURE THAT THE UNIT COMPLIES WITH THESE STANDARDS, OBEY THESE INSTRUCTIONS:

- Use coaxial cable that is of good quality for connections to the L-Band Type 'N' Rx (receive) female connector.
- Use Type 'D' connectors that have back-shells with continuous metallic shielding.
Type 'D' cabling must have a continuous outer shield (either foil or braid, or both). The shield must be bonded to the back-shell.
- Operate the unit with its cover on at all times.

1.2.4.2 European Union Low Voltage Directive (LVD) (2006/95/EC)

Symbol	Description
<HAR>	Type of power cord required for use in the European Community.
	CAUTION: Double-pole/Neutral Fusing ACHTUNG: Zweipolige bzw. Neutralleiter-Sicherung

International Symbols			
Symbol	Definition	Symbol	Definition
	Alternating Current		Protective Earth
	Fuse		Chassis Ground



For additional symbols, refer to Warnings, Cautions and Notes listed earlier in this Preface.

1.2.4.3 European Union RoHS Directive (2002/95/EC)

This unit satisfies (with exemptions) the requirements specified in the European Union Directive on the Restriction of Hazardous Substances in Electrical and Electronic Equipment (EU RoHS, Directive 2002/95/EC).

1.2.4.4 European Union Telecommunications Terminal Equipment Directive (91/263/EEC)

In accordance with the European Union Telecommunications Terminal Equipment Directive 91/263/EEC, the unit should not be directly connected to the Public Telecommunications Network.

1.2.4.5 CE Mark

Comtech EF Data declares that the unit meets the necessary requirements for the CE Mark.

1.3 Product Support

For all product support, please call:

+1.240.243.1880

+1.866.472.3963 (toll free USA)

1.4 Comtech EF Data Headquarters

<http://www.comtechefdata.com>

Comtech EF Data Corp.

2114 West 7th Street

Tempe, Arizona USA 85281

+1.480.333.2200

1.5 Warranty Policy

Comtech EF Data products are warranted against defects in material and workmanship for a specific period from the date of shipment, and this period varies by product. In most cases, the warranty period is two years. During the warranty period, Comtech EF Data will, at its option, repair or replace products that prove to be defective. Repairs are warranted for the remainder of the original warranty or a 90-day extended warranty, whichever is longer. Contact Comtech EF Data for the warranty period specific to the product purchased.

For equipment under warranty, the owner is responsible for freight to Comtech EF Data and all related customs, taxes, tariffs, insurance, etc. Comtech EF Data is responsible for the freight charges only for return of the equipment from the factory to the owner. Comtech EF Data will return the equipment by the same method (i.e., Air, Express, Surface) as the equipment was sent to Comtech EF Data.

All equipment returned for warranty repair must have a valid RMA number issued prior to return and be marked clearly on the return packaging. Comtech EF Data strongly recommends all equipment be returned in its original packaging.

Comtech EF Data Corporation's obligations under this warranty are limited to repair or replacement of failed parts, and the return shipment to the buyer of the repaired or replaced parts.

1.5.1 Limitations of Warranty

The warranty does not apply to any part of a product that has been installed, altered, repaired, or misused in any way that, in the opinion of Comtech EF Data Corporation, would affect the reliability or detracts from the performance of any part of the product, or is damaged as the result of use in a way or with equipment that had not been previously approved by Comtech EF Data Corporation.

The warranty does not apply to any product or parts thereof where the serial number or the serial number of any of its parts has been altered, defaced, or removed.

The warranty does not cover damage or loss incurred in transportation of the product.

The warranty does not cover replacement or repair necessitated by loss or damage from any cause beyond the control of Comtech EF Data Corporation, such as lightning or other natural and weather related events or wartime environments.

The warranty does not cover any labor involved in the removal and or reinstallation of warranted equipment or parts on site, or any labor required to diagnose the necessity for repair or replacement.

The warranty excludes any responsibility by Comtech EF Data Corporation for incidental or consequential damages arising from the use of the equipment or products, or for any inability to use them either separate from or in combination with any other equipment or products.

A fixed charge established for each product will be imposed for all equipment returned for warranty repair where Comtech EF Data Corporation cannot identify the cause of the reported failure.

1.5.2 Exclusive Remedies

Comtech EF Data Corporation's warranty, as stated is in lieu of all other warranties, expressed, implied, or statutory, including those of merchantability and fitness for a particular purpose. The buyer shall pass on to any purchaser, lessee, or other user of Comtech EF Data Corporation's products, the aforementioned warranty, and shall indemnify and hold harmless Comtech EF Data Corporation from any claims or liability of such purchaser, lessee, or user based upon allegations that the buyer, its agents, or employees have made additional warranties or representations as to product preference or use.

The remedies provided herein are the buyer's sole and exclusive remedies. Comtech EF Data shall not be liable for any direct, indirect, special, incidental, or consequential damages, whether based on contract, tort, or any other legal theory.

Chapter 1. INTRODUCTION

1.1 Overview

Comtech EF Data's MBT-5000A L-Band Up/Down Converter System provides frequency conversion between L-Band IF and C-/X-/Ku-/Ka-Band RF frequencies.

The MBT-5000A, shown in **Figure 1-1**, features a drop-down front panel providing access to two upconverter modules, or two downconverter modules, or one of each.



Figure 1-1. MBT-5000A L-Band Up/Down Converter

1.2 Functional Description

The MBT-5000A's 1RU-high, 19-inch wide chassis is designed for rack mounting into a standard 19-inch equipment rack. Handles installed on the front panel facilitate ease of installation into and removal from the equipment rack. The unit may be freestanding if desired.

All operator controls, indicators and displays for local and remote operation are located on the front panel of the MBT-5000A. The drop-down design of the front panel provides user access to the two internal upconverter or downconverter modules.

External interface connectors are located on the rear panel of the MBT-5000A chassis. External equipment, e.g., a modem, is connected to each internal converter module via a standard, off-the-shelf coaxial cable. A coaxial cable is also used to connect the output for each module to RF equipment either at the same location or at the antenna location.

When configured with the redundancy option, the system may contain two diode “OR-ed” internal power supplies for increased reliability and microprocessor-based Monitor and Control (M&C) functionality.

Figure 1-2 depicts the operational schematics for typical MBT-5000A L-Band Up/Downconverter System single thread (standalone) and redundant applications. For more information about the MBT-5000A’s use in redundant applications, see **Appendix B. MBT-5000A REDUNDANCY OPERATION.**

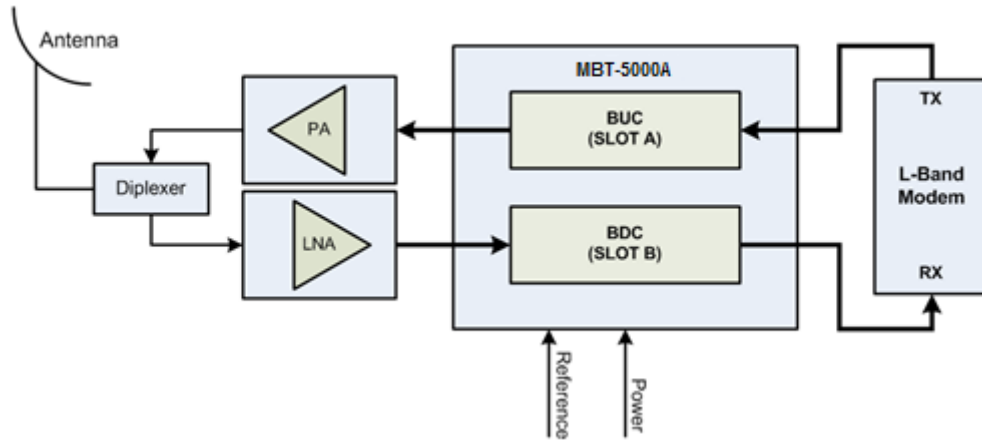

MBT-5000A Single Thread (Standalone) Application

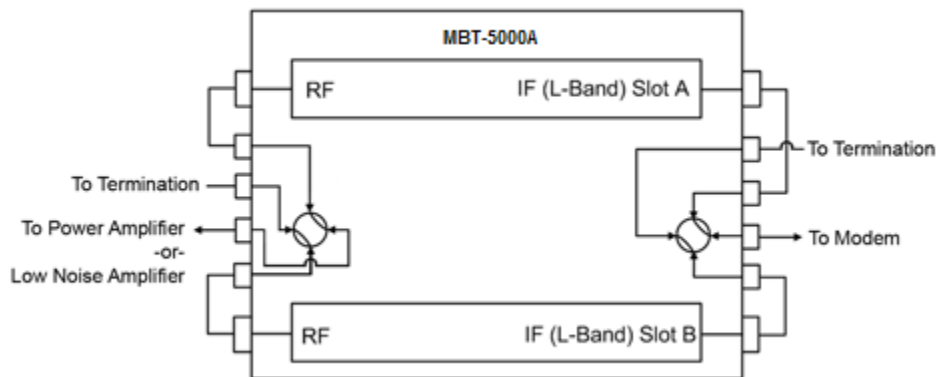

MBT-5000A Redundant Application (Single LNA Application shown)

Figure 1-2. MBT-5000A Operational Schematics

1.3 Features

- Meets or exceeds IESS-308/309
- Low phase noise
- 30 dB gain adjustment
- Flexible configuration
- RF Ku Band switching in minimal time without requiring tools
- Optional 1:1 Redundancy in a 1RU chassis
- EIA-232/485
- Ethernet/Telnet/SNMP
- Powerful Monitor and Control (M&C) support
- Facilitates 188-164B system compliance

1.3.1 Block Upconverter (BUC-5000A)

The BUC-5000A field interchangeable upconverter module translates an L-Band input frequency block up to the band specific RF output frequency block (C-Band, X-Band, Ku-Band, or Ka-Band).

Note the following:

C-Band	5850 to 6650 MHz
X-Band	7900 to 8400 MHz
Ku-Band	13.75 to 14.50 GHz
Ka-Band Commercial Band-1	27.5 to 28.5 GHz
Ka-Band Commercial Band-2	28.3 to 29.3 GHz
Ka-Band Commercial Band-3	29.0 to 30.0 GHz
Ka-Band Military Band	30.0 to 31.0 GHz

1.3.2 Block Downconverter (BDC-5000A)

The BDC-5000A field-interchangeable module translates a band-specific RF input frequency block (C-Band, X-Band, Ku-Band, or Ka-Band) from the Low Noise Amplifier (LNA) down to the corresponding L-Band block.

Note the following:

C-Band	3400 to 4200 MHz (Non-Invert optional)
X-Band	7250 to 7750 MHz
Ku-Band	10.95 to 11.70 GHz 11.70 to 12.20 GHz (Switched LO) 12.20 to 12.75 GHz
Ku-Band 2	10.95 to 11.70 GHz 11.70 to 12.75 GHz (Switched LO)
Ka-Band Commercial Band-1	17.7 to 18.7 GHz
Ka-Band Commercial Band-2	18.5 to 19.5 GHz
Ka-Band Commercial Band-3	19.2 to 20.2 GHz
Ka-Band Military	20.2 to 21.2 GHz

1.4 Summary of Specifications

1.4.1 Physical & Environmental

Weight		15 lbs. (6.80 kg) Nominal
Dimensions (excluding connectors)		1.75" x 19" x 15" (See Figure 1-3)
Temperature	Operating	-25.6° to 140°F (-32° to 60°C)
	Non-operating (Storage)	-40° to 159.8°F (-40° to 71°C)
Altitude	Operating	-120 to 10,000 ft. above sea level
	Non-operating	-120 to 35,000 ft. above sea level
Humidity		5 to 95%, non-condensing
Non-Operating Shock		Sinusoidal 2.3G, 20 ms duration any axis

1.4.2 Prime Power

Voltage	85 – 265 VAC, -48 VDC Optional
Frequency	47 to 65 Hz
Dissipation	70 Watts, typical

1.4.3 Monitor & Control

Serial M&C Interface	TIA/EIA-232, TIA/EIA-485, 4-wire 9-pin D, Female
Alarm	Form C 9-pin D, Female
Redundant Switch Connections	SMA Female 2.92 mm for Ka-Band
Remote Interface	RJ-45 Ethernet

1.4.4 Reference

External Input		5 or 10 MHz, 0 ±5 dBm BNC Female, 50 Ω, Return Loss 15 dB
Internal Output		5 or 10 MHz, +5.0 dBm, Min BNC Female, 50 Ω
Internal	Thermal Stability	±1x10E-08
	Ageing, per Day	±3x10E-10
	Ageing, per Year	±3x10E-08

1.4.5 BUC-5000A Block Upconverters

Frequency Bands (by Model)	Model	RF Output	IF Input	LO
	BUC-5000AC	5850-6650 MHz	950-1750 MHz	4900 MHz
	BUC-5000AX	7900-8400 MHz	950-1450 MHz	6950 MHz
	BUC-5000AKu	13.75-14.50 GHz	950-1700 MHz	12.80 GHz
	BUC-5000AKa1	27.50-28.50 GHz	1000-2000 MHz	26.50 GHz
	BUC-5000AKa2	28.30-29.30 GHz	1000-2000 MHz	27.30 GHz
	BUC-5000AKa3	29.00-30.00 GHz	1000-2000 MHz	28.00 GHz
	BUC-5000AKaM	30.00-31.00 GHz	1000-2000 MHz	29.00 GHz
Input/Output Impedance		50 Ω		
Input Return Loss		15 dB minimum		
Output Return Loss		15 dB minimum		
Input Connector		Type 'N' Female (Type 'SMA' for Redundancy option)		
Output Connector		Type 'N' Female (Type 'SMA' for Redundancy option) 2.92 mm for Ka-Band		
Gain		35 dB nominal at 0 dB Atten., ±2.0 dB		
	Full Band	Constant Temp – ±0.25dB		
		-32° to +60° C – ±1.00 dB		
	Per 40 MHz Slope	.03 dB/MHz maximum		
Mute		-80 dBm, Max.		
User Attenuation Range		0 to 30 dB, in 0.25 dB steps		
Input P1dB With 10 dB Attenuation		≥ -12 dBm		

Output Power, P1dB		15 dBm minimum
Noise Figure		15 dB at 0 dB Attenuation
Intermodulation Distortion		-50 dBc at 0.0 dBm SCL
Spurious (In-band)	Carrier Related	-63 dBc
	Non-Carrier Related	-60 dBm
Phase Noise		Meets or exceeds MIL-STD-188-164B

1.4.6 BDC-5000A Block Downconverters

Frequency Bands (by Model)		Model	RF Output	IF Input	LO
		BDC-5000ACNI (Non-inverting)	3400-4200 MHz	950-1750 MHz	11600 MHz 9150 MHz
		BDC-5000AX	7250-7750 MHz	950-1450 MHz	6300 MHz
		BDC-5000AKu Switched LO	10.95-11.70 GHz	950-1700 MHz	10.00 GHz
			11.70-12.20 GHz	950-1450 MHz	10.75 GHz
			12.20-12.75 GHz	950-1500 MHz	11.25 GHz
		BDC-5000AKu2 Switched LO	10.95-11.70 GHz	950-1700 MHz	10.00 GHz
			11.70-12.75 GHz	950-2000 MHz	10.75 GHz
		BDC-5000AKa1	17.70-18.70 GHz	1000-2000 MHz	16.70 GHz
		BDC-5000AKa2	18.50-19.50 GHz	1000-2000 MHz	17.50 GHz
		BDC-5000AKa3	19.20-20.20 GHz	1000-2000 MHz	18.20 GHz
BDC-5000AKaM	20.20-21.20 GHz	1000-2000 MHz	19.20 GHz		
Input/Output Impedance			50Ω		
Input Return Loss			15 dB minimum		
Output Return Loss			15 dB minimum		
Input Connector			Type 'N' Female (Type 'SMA' for Redundancy option) 2.92 mm SMA Female for Ka-Band		
Output Connector			Type 'N' Female (Type 'SMA' for Redundancy option)		
Gain		40 dB nominal at 0 dB Atten., ±3.0 dB			
		Full Band	Contant Temp – ±0.25 dB		
			-32° to +60° C – ±1.0 dB		
Per 40 MHz Slope	.03 dB/MHz maximum				
Mute			-80 dBm		
User Attenuation Range			0 to 30 dB, in 0.25 dB steps		
Input P1dB with 10 dB Attenuation			≥ -5 dBm		
Output Power, P1dB			26 dBm minimum		
Noise Figure			15 dB at 0 dB Attenuation		
Intermodulation Distortion			-50 dBc at 3.0 dBm Total Output		
Spurious (In-band)		Carrier Related	-63 dBc		
		Non-Carrier Related	-60 dBm		
Phase Noise			Meets or exceeds MIL-STD-188-164B		

1.5 Dimensional Envelope

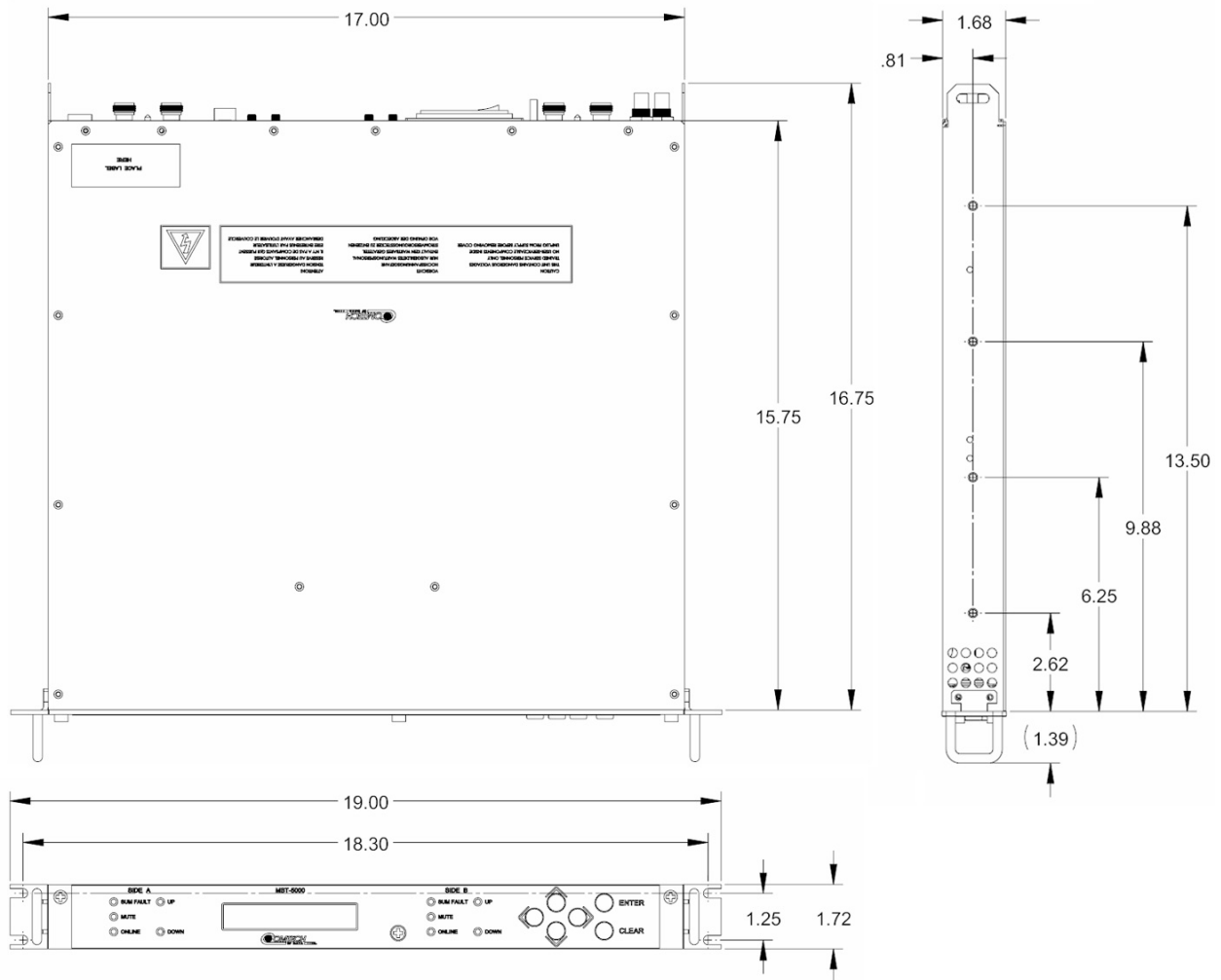

Figure 1-3. MBT-5000A Dimensional Envelope

Chapter 2. INSTALLATION

2.1 Unpack and Inspect the Shipment

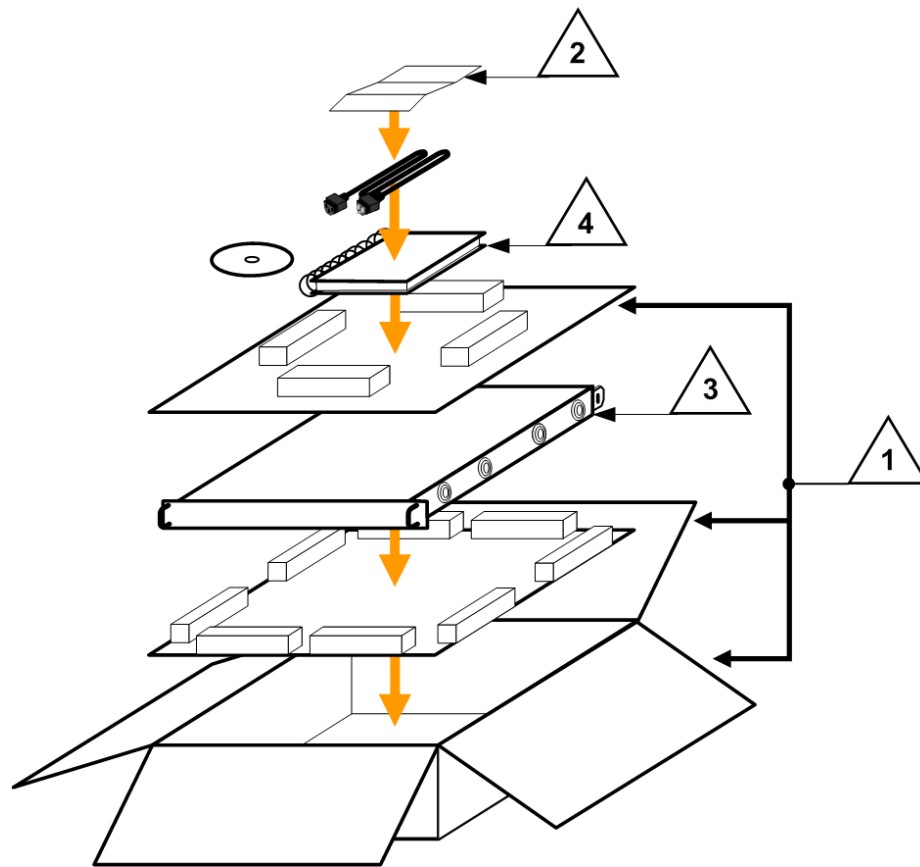

Figure 2-1. MBT-5000A Packing/Shipping Diagram

The MBT-5000A L-Band Up/Down Converter System, its optional Installation and Operation Manual (otherwise available online at <https://www.comtechedata.com/>), and its power cord are packaged and shipped in a reusable cardboard carton containing protective foam spacing.



CAUTION – THIS EQUIPMENT CONTAINS PARTS AND ASSEMBLIES SENSITIVE TO DAMAGE BY ELECTROSTATIC DISCHARGE (ESD). USE ESD PRECAUTIONARY PROCEDURES WHEN HANDLING THE EQUIPMENT.



Once opened, inspect the shipment:

Step	Task
1	Keep all shipping materials.
2	Check the packing list to make sure the shipment is complete.
3	Inspect the equipment for damage. If damage exists, immediately contact the carrier and CEFD to submit a damage report.
4	Read the manual.

2.2 Install the Unit Into a Rack Enclosure

Install the MBT-5000A in its assigned position in the rack enclosure (**Figure 2-2**). Use, as required:

- A standard rack-mounted shelf;
- User-supplied screws to secure the front panel to the rack enclosure threaded front mounting rails;
- CEFD’s optional KT/6228-2 (4”) or KT/6228-3 (10”) Rear-Mounting Support Brackets Kit (**Figure 2-3**);
- CEFD’s optional FP/SL0006 (26”), FP/SL0007 (24”), or FP/SL0008 (22”) Bearingless Rack Slide Set (**Figure 2-4**).

For information about custom rack enclosures and these optional installation accessories, contact CEFD Product Support.



CAUTION – OBSERVE THE FOLLOWING:

- **CORRECT GROUNDING PROTECTION IS REQUIRED TO PREVENT PERSONAL INJURY AND EQUIPMENT DAMAGE.**
You must make sure the ground stud on the rear panel of the unit is always connected to the protective earth.
- **SUFFICIENT AIR VENTILATION IS REQUIRED –** Make sure there is adequate air ventilation clearance inside the enclosure, especially at the side. In a rack system where there is high heat discharge, provide forced-air cooling with top- or bottom-mounted fans or blowers.
- **MAXIMUM AIR TEMPERATURE –** Make sure the air temperature inside the enclosure **never** exceeds 60°C (140°F).

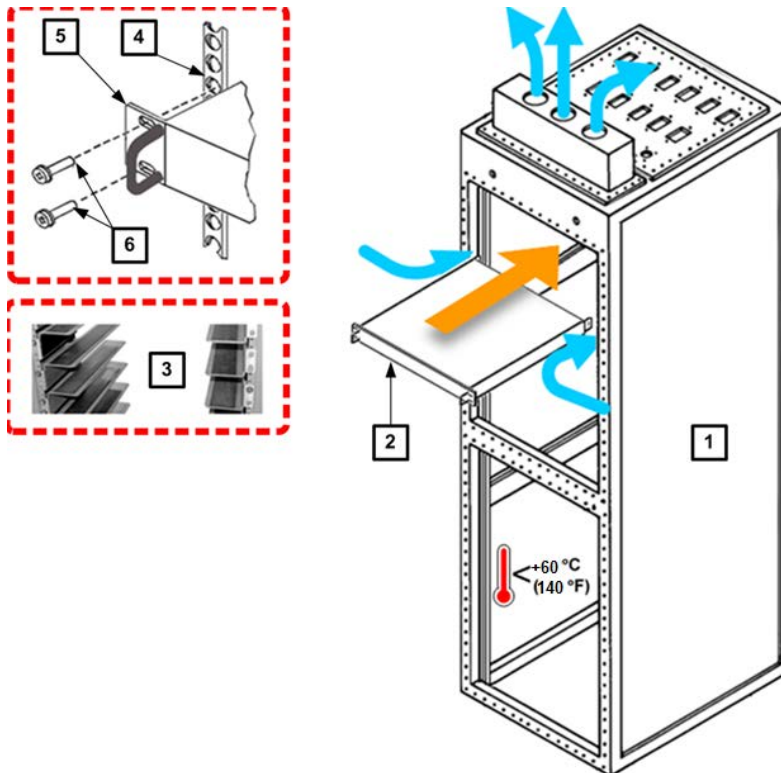

Item	Description
1	Custom Rack Enclosure
2	MBT-5000A Up/Down Converter System
3	Standard Rack Shelving
4	Rack Enclosure Threaded Front Rail (typical)
5	Unit Front Panel
6	User-supplied Screws

Figure 2-2. Unit Rack Enclosure Installation

2.2.1 Optional Rear-Mounting Support Brackets Kit Installation

Use the following tools to install the KT/6228-2 (4") or KT/6228-3 (10") Rear-Mounting Support Brackets Kit (**Figure 2-3**):

- A medium Phillips™ screwdriver
- A 5/32-inch SAE Allen™ Wrench
- An adjustable Crescent™ wrench.

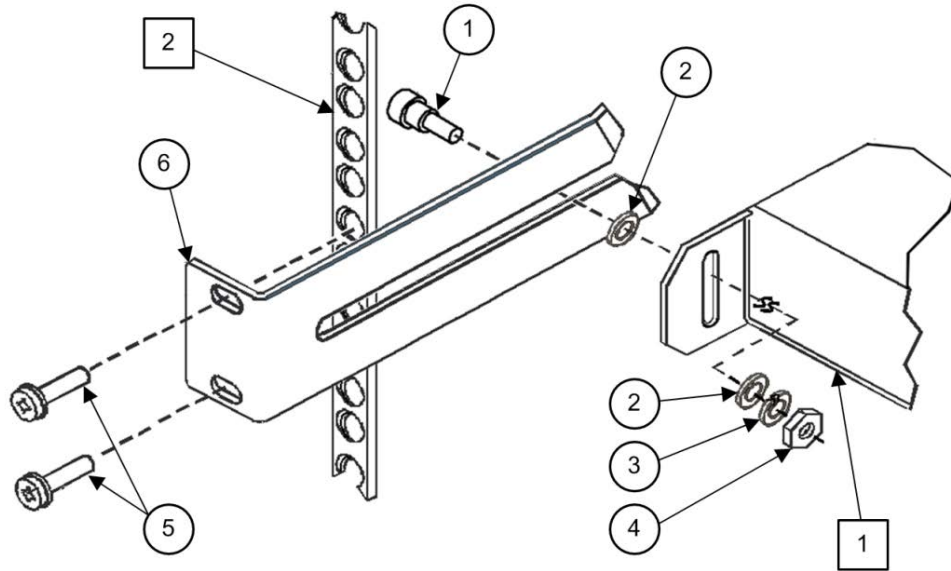

Detail	Description
1	Back of Unit
2	Rack Enclosure Threaded Rear Mounting Rail (typical)

Item	Quantity per CEFD Kit		Part Number	Description
	KT/6228-2	KT/6228-3		
1	2	2	HW/10-32SHLDR	Shoulder Screw, #10
2	4	4	HW/10-32FLT	Flat Washer, #10
3	2	2	HW/10-32SPLIT	Lock Washer, #10
4	2	2	HW/10-32HEXNUT	Hex Nut, #10
5	4	4	HW/10-32x1/2RK	Bolt, #10, Rear Support Bracket
6	2	–	FP/6138-2	Bracket, Rear Support – 4"
	–	2	FP/6138-3	Bracket, Rear Support – 10"

Figure 2-3. Optional Rear-Mounting Support Brackets Kit Installation

To install either kit, do these steps:

Step	Task
1	Use the #10 flat washers, #10 split washers, and #10 hex nuts to secure the #10 shoulder screws to the unit chassis through the rear right and left side mounting slots.
2	Use the #10 rack bracket bolts to install the rear support brackets onto the rack enclosure threaded rear mounting rails.
3	Mount the unit into the rack enclosure. Ensure that the shoulders of the #10 shoulder screws properly engage into the rear support bracket slots.

2.2.2 Install the Optional Bearingless Rack Slide Set

If you wish to mount the converter on slides, you may install an optional bearingless rack slide set (**Figure 2-4**) into the rack cabinet and onto the sides of the MBT-5000A. Use the hardware provided with the slide set that is appropriate for your specific installation:

CEFD Part Number	Description
FP/SL0006	Bearingless Rack Slide Set – 26"
FP/SL0007	Bearingless Rack Slide Set – 24"
FP/SL0008	Bearingless Rack Slide Set – 22"

To install any of these optional bearingless rack slide sets, do these steps:

Step	Task
1	Use the provided mounting hardware to install one slide onto each side of the MBT-5000A chassis.
2	Use the provided mounting hardware to install the slide rail components into each side of the rack cabinet.
3	Mount the unit into the equipment rack – make sure that the slides properly engage the cabinet-mounted slide rails.
4	Slide the converter into the rack cabinet until the front panel's back surfaces abut the rack cabinet's front mounting rails.
5	Use four user-provided screws to secure the converter to the rack cabinet front mounting rails (see Figure 2-2).

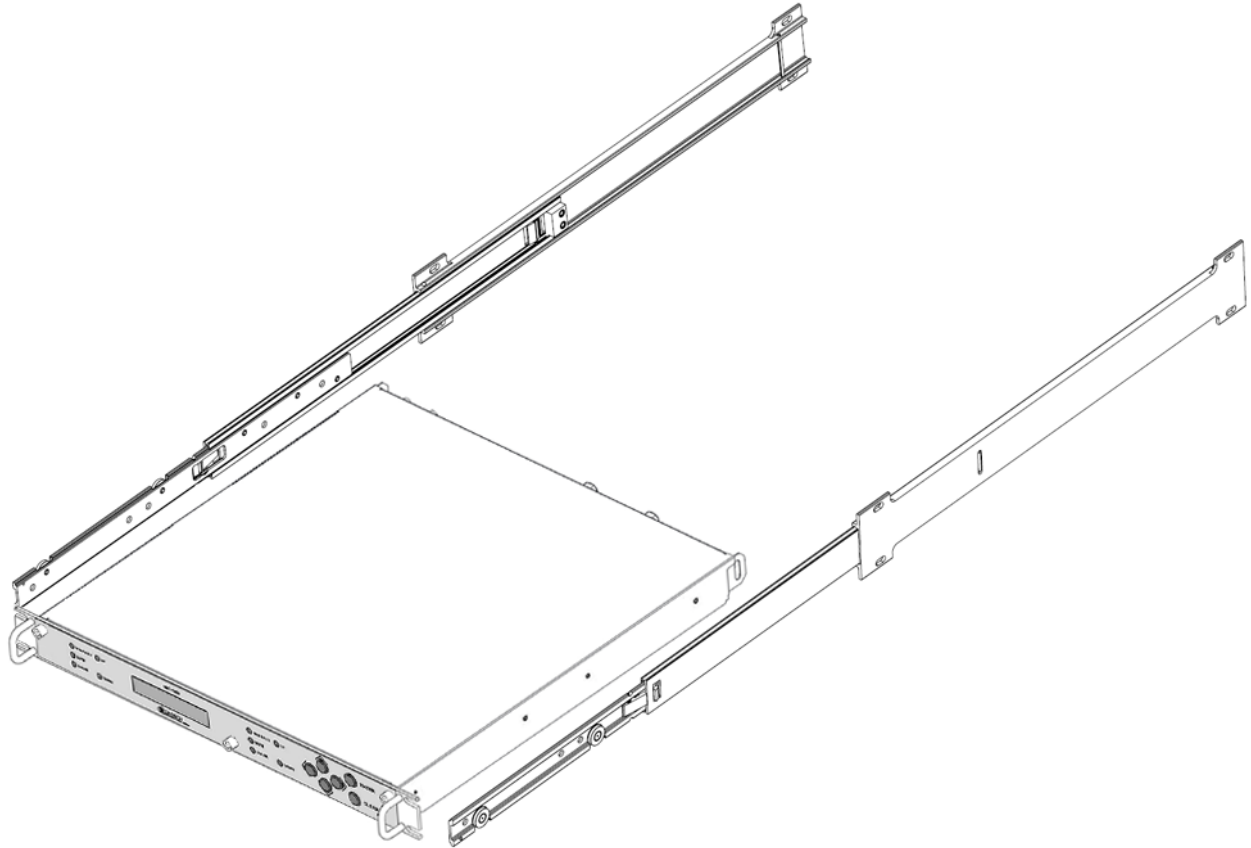

Figure 2-4. Optional Bearingless Rack Slide Installation (FP/SL000X)

Chapter 3. REAR PANEL CONNECTIONS

3.1 Cabling Connection Types

The MBT-5000A L-Band Up/Down Converter System uses a number of different cables. Each cable type is typically dedicated to a specific mode of operation.



Not all of these operational interface types may be available with this product.

3.1.1 Coaxial Cable Connections





Coupling Type	Connector Type	
	Plug	Jack
Bayonet (Type 'BNC' shown)		
Threaded (Type 'N' shown)		

Figure 3-1. Coaxial Connector Examples

The types of coaxial cables used by CEFD are **'BNC'**, **'TNC'**, **'N'**, **'F'**, and **'SMA'**. Coaxial cables (plugs) and their mating connectors (jacks/sockets) are available in two coupling styles – **Bayonet** or **Threaded**:

- **Bayonet Coupling Style:** The jack has a pair of guide posts that accommodate the plug's lockdown slots. This lockdown design provides secure assembly without over-tightening the connection.
- **Threaded Coupling Style:** The jack features external threads. The plug shell features internal threads, and has either a knurled outer surface to permit hand-tightening of the connection, or hex flats to accommodate torqued installation.

Connection Instructions:

- **Bayonet Coupling Connections:** Use the plug slots to guide, then slide the plug onto the jack posts. Then, turn the plug clockwise until the jack posts are fully seated within the plug slot.
- **Threaded Coupling Connections:** Engage the plug onto the jack threads, and then turn the plug clockwise until it is fully threaded onto the jack. Do not over-tighten the connection.

3.1.1.1 Type 'BNC'

BNC plugs and jacks feature a **Bayonet Coupling** design.



3.1.1.2 Type 'TNC'

TNC plugs and jacks feature a **Threaded Coupling** design similar to Type 'N', Type 'F,' and Type 'SMA' connectors.

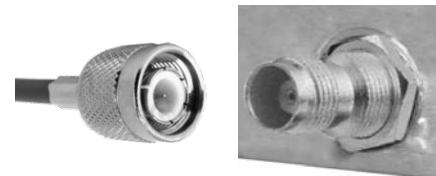

3.1.1.3 Type 'N'

Type 'N' connectors feature a **Threaded Coupling** design similar to Type 'TNC', Type 'F', and Type 'SMA' connectors.

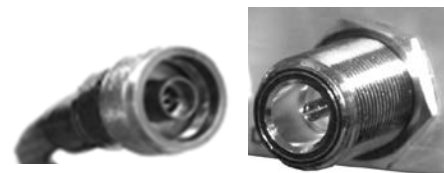

3.1.1.4 Type 'F'

Type 'F' connectors feature a **Threaded Coupling** design similar to Type 'TNC', Type 'N', and Type 'SMA' connectors.

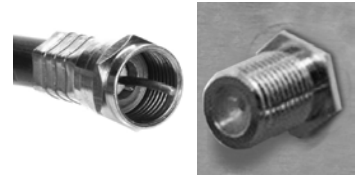

3.1.1.5 Type 'SMA' (Subminiature Version 'A')

Type 'SMA' connectors feature a **Threaded Coupling** design similar to Type 'TNC', Type 'N', and Type 'F' connectors.

Note: SMA 2.92 mm requires torque wrench.

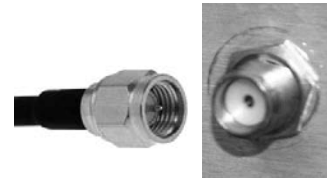

3.1.2 D-Subminiature Cable Connections

Type 'D' Connection Type	Example
<p style="text-align: center;">Chassis Receptacles: Female (top) Male (bottom)</p>	
<p style="text-align: center;">Type 'D' Cable with Jack Screws (female shown)</p>	

Figure 3-2. D-Subminiature Connector Examples

D-Subminiature connectors are also called **Type 'D'** or '**D-Sub**' connectors. The connector pair features multiple rows of pins (male side) coupled to mating sockets (female side). The cable plug and chassis receptacle each feature a D-shaped profile that interlock to ensure proper pin orientation and connector seating.

Either chassis receptacle gender features two jack nuts for secure assembly of the cable plug to the chassis receptacle.

Whether its gender is male or female, the cable plug features two jack screws for secure connection to the jack nuts provided on its mating chassis receptacle. The jack screws may be hand tightened or tightened with a standard flat-blade screwdriver.

Connection Instructions: Orient the plug to the receptacle in the proper position. Press firmly into place. Use the jack screws to secure the plug to the receptacle jack nuts. Do not over-tighten.

3.1.3 RJ-45, RJ-48 Cable Connections

The plug for an RJ-45 or RJ-48 cable features a flexible tab. The RJ-45 or RJ-48 jack features a mating slot. This design configuration assures proper installation and pin orientation.

Connection Instructions: Press down the tab on the cable plug, and then insert the plug into the RJ-4x jack. The connection is complete when the tab 'clicks' into position inside the jack.



3.2 MBT-5000A Cabling Connections



(Optional Redundancy Unit w/Standard AC Power Shown)

Figure 3-3. MBT-5000A Cabling Connections

The MBT-5000A rear panel connectors, shown here in **Figure 3-1**, provide all necessary external connections between the unit and other equipment. The table that follows summarizes the connectors provided here, grouped according to service function.

Table 3-1. MBT-5000A Connectors

Connector Group		Connector Type	Ref Des	Connector Name	Function
Sect.	Service Type				
3.2.1	IF Group	Type 'N' female	J4	IF OUT/IN	Side B Module IF output/input
			J5	RF IN/OUT	Side B Module RF input/output
			J6	IF OUT/IN	Side A Module IF output/input
			J7	RF IN/OUT	Side A Module RF input/output
3.2.2	Optional Redundancy Groups	Type 'SMA' female	RF	B SEC	Redun (top): To J5 RF In/Out
					Redun (bottom): To PA or LNA
			A PRI	Redun (top): To Termination	
				Redun (bottom): To J7 RF In/Out	
		Type 'SMA' female	IF	B SEC	Redun (top): To J4 IF In/Out
					Redun (bottom): To Modem
			A PRI	Redun (top): To Termination	
				Redun (bottom): To J6 IF In/Out	
3.2.3	Utility Group	BNC female	J2	EXT REF IN	External 10 MHz Reference input
		BNC female	J8	EXT REF OUT	External 10 MHz Reference output
		RJ-45	J9	10/100 ETHERNET	10/100 Ethernet M&C
		9-Pin Type 'D' female	P1	RELAY	Form C Side Alarm
		9-Pin Type 'D' male	J1	COM 1	Serial Remote Control Interface



- 1) The European EMC Directive (EN55022, EN50082-1) requires using properly shielded cables for DATA I/O. These cables must be double-shielded from end-to-end, ensuring a continuous ground shield.
- 2) See Sect. 3.1 Cabling Connections Types for information about each connector type and its connection instructions.

3.2.1 IF Connector Group



Appendix A. BUC-5000Ax/BDC-5000Ax MODULE REMOVAL/INSTALLATION



These connectors are integral components of the BUC/BDC modules installed in the MBT-5000A chassis Side A and Side B module bays.

3.2.1.1 'J4 | IF OUT/IN' (Side B) Connector (Type 'N' Female)



This connector is a Type 'N' female connector that provides either an L-Band input signal interface (with the BUC-5000A Block Upconverter installed), or an L-Band output signal interface (with the BDC-5000A Block Downconverter installed).

3.2.1.2 'J5 | RF IN/OUT' (Side B) Connector (Type 'N' Female)



This connector is a Type 'N' female connector that provides either an upconverted RF output signal (with the BUC-5000A Block Upconverter installed), or a downconverted RF input signal (with the BDC-5000A Block Downconverter installed).

3.2.1.3 'J6 | IF OUT/IN' (Side A) Connector (Type 'N' Female)



This connector is a Type 'N' female connector that provides either an L-Band input signal interface (with the BUC-5000A Block Upconverter installed), or an L-Band output signal interface (with the BDC-5000A Block Downconverter installed).

3.2.1.4 'J7 | RF IN/OUT' (Side A) Connector (Type 'N' Female)



This connector is a Type 'N' female connector that provides either an upconverted RF output signal (with the BUC-5000A Block Upconverter installed), or a downconverted RF input signal (with the BDC-5000A Block Downconverter installed).

3.2.2 Optional Redundancy Groups



See the “Function” column in Table 3-1 in this chapter, and Figure B-2 in Appendix B. MBT-5000A REDUNDANCY OPERATION for interconnection between these connectors to others located on the MBT-5000A rear panel and on other external equipment.

3.2.2.1 Optional ‘RF’ Connectors (Type ‘SMA’ Female)



The ‘RF’ PRI (Primary) A / SEC (Secondary) B connector pairs are Type ‘SMA’ female connectors that provide the RF “baseball” switch for optional redundant operations.

3.2.2.2 Optional ‘IF’ Connectors (Type ‘SMA’ Female)



The ‘IF’ PRI (Primary) A / SEC (Secondary) B connector pairs are Type ‘SMA’ female connectors that provide the IF “baseball” switch for optional redundant operations.

3.2.3 Utility Connector Group

3.2.3.1 ‘J2 | EXT REF IN’ – External Reference Input Connector (BNC-F)



This BNC female connector is used to supply a master reference to the entire chassis. The user-supplied input signal is used for phase-locking the internal 10 MHz reference oscillator to a user-provided 5 or 10 MHz station clock. The impedance is matched for 50/75Ω, and requires an input level of 0 ±5 dBm.

3.2.3.2 ‘J8 | EXT REF OUT’ – External Reference Output Connector (BNC-F)



This BNC female connector provides a 10 MHz reference for customer use. The impedance is matched for 50/75Ω, and provides an output level of 5 ±3 dBm.

3.2.3.3 'J9 | 10/100 ETHERNET' 10/100 BaseT M&C Port (RJ-45)



Chapter 6. ETHERNET-BASED REMOTE PRODUCT MANAGEMENT



This standard RJ-45 female modular jack is used for product M&C using Simple Network Management Protocol (SNMP), Telnet, and Hypertext Transfer Protocol (HTTP). It is also used for MBT-5000A firmware updates. A CAT5e Unshielded Twisted Pair (UTP) cable is used to connect to an Ethernet hub, router, switch, personal computer (PC), etc.

Table 3-2. 'J9 | 10/100 ETHERNET' Connector Pinout

Pin #	Description	Direction
1	Tx+	Out
2	TX-	Out
3	Rx+	In
4	N/A	
5	N/A	
6	Rx-	In

3.2.3.4 'P1 | RELAY' Summary Fault Output Connector (DB-9F)



This summary fault output connector is a 9-pin Type "D" female connector (DB-9F). Its mating connector is a DB-9M connector.

Table 3-3. 'P1 | RELAY' Connector Pinout

Pin #	Description
5	GND
9	NC
4	SUMFLT2_NO
8	SUMFLT2_COM
3	SUMFLT2_NC
7	EXT_FLT_IN#
2	SUMFLT1_NO
6	SUMFLT1_COM
1	SUMFLT1_NC
Notes: 1) Pin 1 to Pin 6: Converter A Fault 2) Pin 2 to Pin 6: Converter A OK 3) Pin 3 to Pin 8: Converter B Fault 4) Pin 4 to Pin 8: Converter B OK	

3.2.3.5 'J1 | COM 1' EIA-485/232 Interface Connector (DB-9F)



Chapter 7. SERIAL-BASED REMOTE PRODUCT MANAGEMENT



This EIA-485/EIA-232 interface connector is a 9-pin Type "D" female connector (DB-9F). Its mating connector is a DB-9M connector.

Table 3-4. 'J1 | COM1' 2-Wire EIA-485 Interface Connector Pinout

Pin #	Description	Function
5		
9	+RX/TX	Signal
4		
8	-RX/TX	Signal Complement
3		
7	+RX/TX	Signal
2		
6	-RX/TX	Signal Complement
1	GND	Ground

Table 3-5. 'J1 | COM1' 4-Wire EIA-485 Interface Connector Pinout

Pin #	Description	Function
5		
9	+TX	Signal
4		
8	-TX	Signal Complement
3		
7	+RX	Signal
2		
6	-RX	Signal Complement
1	GND	Ground

**Table 3-6. 'J1 | COM1' EIA-232
Interface Connector Pinout**

Pin #	Description	Function
5		
9		
4		
8		
3	RD	Receive Data
7		
2	TD	Transmit Data
6		
1		

3.3 MBT-5000A Ground and Power Connections

3.3.1 Chassis Ground Interface



CAUTION – PROPER GROUNDING PROTECTION IS REQUIRED. The equipment must be connected to the protective earth connection at all times. It is therefore imperative that the unit is properly grounded, using the ground stud provided on the unit rear panel, during installation, configuration, and operation.



The AC power interface provides the safety ground.



(Optional Redundancy Unit w/Standard AC Power Shown)

Figure 3-4. MBT-5000A Chassis – Common Ground Interface



This #10-32 stud is located at a common chassis location to the left-hand side of the standard AC, optional dual AC, or optional DC power module (**Figure 3-4**). Use this stud for connecting a common chassis ground among equipment.

3.3.2 Alternating Current (AC) Power Interfaces

3.3.2.1 Standard 90-260V Alternating Current (AC) Power Interface

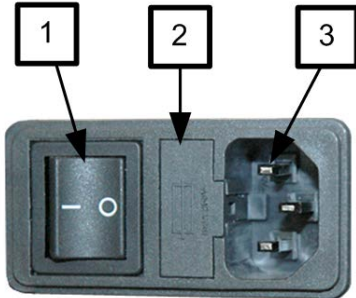

Feature	Description
1	On / Off Switch
2	Press-fit Fuse Holder
3	IEC Three-prong Connector

AC Power Specifications	
Input Power	75W maximum, less than 65 W typical
Input Voltage	90 to 260 VAC
Connector Type	IEC-320
Fuse Protection	Line and neutral fusing – (2X) T2.0A 20 mm slow-blow fuses

Figure 3-5. MBT-5000A Standard AC Power Interface

3.3.2.1.1 Standard 90-260V AC Operation – Apply Power



Figure 3-6. MBT-5000A AC Power

To apply AC power to the MBT-5000A, do these steps:

- **First**, plug the provided AC power cord female end into the unit.
- **Then**, plug the AC power cord male end into the user-supplied power source.
- **Finally**, switch the unit ON.

3.3.2.1.2 Standard 90-260V AC Operation – Replace the Fuses



WARNING! DISCONNECT THE POWER SUPPLY BEFORE PROCEEDING!



CAUTION – FOR CONTINUED OPERATOR SAFETY, ALWAYS REPLACE THE FUSES WITH THE CORRECT TYPE AND RATING.

The MBT-5000A uses two 20 mm slow-blow fuses – one each for line and neutral connections (L1, L2 where appropriate). The fuses are located in the rear panel at the International Electrotechnical Commission (IEC) AC power supply module (**Figure 3-7**). The fuses are contained within a fuse holder that is press-fit into the body of the module.



Figure 3-7. MBT-5000A AC Fuse Replacement

To replace the AC fuses, do these steps:

- **First**, unseat the fuse holder from the IEC power module.
 - Use the slot to pry the holder outward from the IEC power module.
 - Pull the holder straight out, and then swing the holder away from the module.
- **Then**, remove and replace the fuses as needed.
 - Use T2.0A (2 Amp) fuses for standard operation.
- **Finally**, re-seat the fuse holder in the IEC power module.

3.3.2.2 Optional Dual Entry Module Alternating Current (AC) Power Interface (Redundancy Units Only)

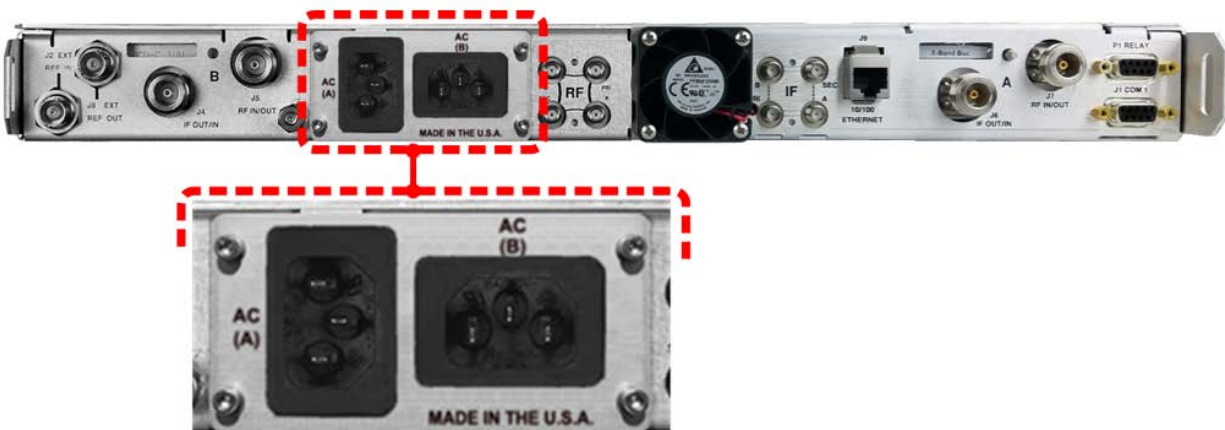
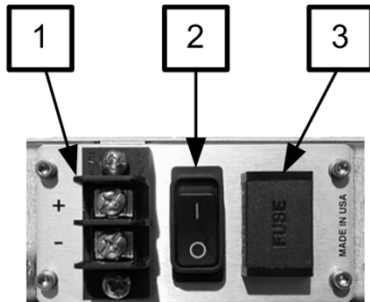

Figure 3-8. MBT-5000A Optional Dual Entry Module AC Power Interface

3.3.3 DC Power Interfaces

3.3.3.1 Optional -48V Direct Current (DC) Power Interface



Feature	Description
1	Power Terminal Block
2	On / Off Switch
3	Fuse Holder

DC Power Specifications	
Input Power	75W maximum, less than 65W typical
Input Voltage	36 to 72 VDC
Connector Type	Terminal Block
Fuse Protection	(1X) 3.15A 5 x 20mm slow-blow fuse

Figure 3-9. MBT-5000A Optional DC Power Interface

3.3.3.1.1 Optional -48V DC Operation – Apply Power



Figure 3-10. MBT-5000A DC Power

To apply DC power to the MBT-5000A, do these steps:

- **First**, connect the user-supplied (+) and (-) DC power leads to their respective terminals. Number 18 AWG minimum wires are recommended.
- **Then**, connect the user-supplied DC power leads to the power source.
- **Finally**, switch the unit ON.

3.3.3.1.2 Optional -48V DC Operation – Replace the Fuse



WARNING! DISCONNECT THE POWER SUPPLY BEFORE PROCEEDING!



CAUTION – FOR CONTINUED OPERATOR SAFETY, ALWAYS REPLACE THE FUSES WITH THE CORRECT TYPE AND RATING.

The optional -48V DC MBT-5000A uses a single 20 mm slow-blow fuse. A latched fuse holder is located on the rear panel, on the DC power supply (terminal block) module (**Figure 3-11**).

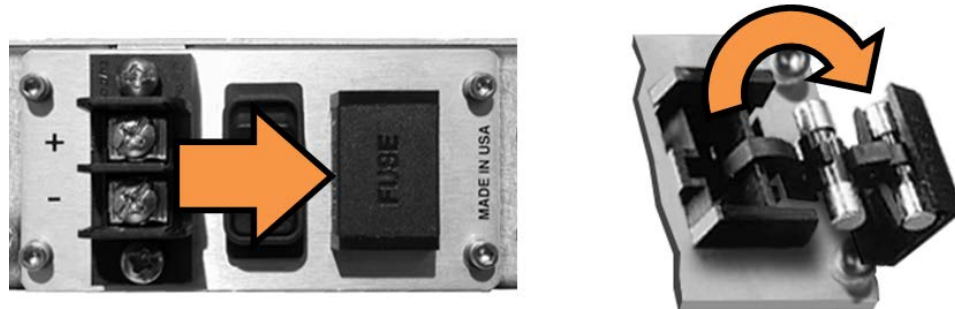

Figure 3-11. MBT-5000A DC Fuse Replacement

To replace the DC fuse, do these steps:

- **First**, press on the fuse holder cover, where shown in **Figure 3-11**, to unlatch the cover. Pull out the fuse carrier from its receptacle, and then swing out as shown.
- **Then**, remove and replace the fuse (the fuse carrier features a cradle that stores a spare fuse):
 - Use 3.15 Amp 5 x 20 mm slow-blow fuses for standard operation
- **Finally**, swing back, and then push the fuse carrier back into its receptacle. Continue to push in until the cover latch clicks back into its locked position.

Chapter 4. UPGRADING FIRMWARE

4.1 Overview



Make sure to operate the MBT-5000A with its latest available firmware.

The MBT-5000A L-Band Up/Down Converter System is factory-shipped with its latest version of operating firmware. If you need to update the converter firmware, you may download the update from the CEFD Web site (www.comtechefdata.com). You may also receive the firmware update archive file via e-mail from CEFD Product Support.

You may perform the firmware update, without opening the MBT-5000A, remotely over satellite, or by directly connecting a user-supplied Microsoft Windows-based PC to the '**J9 | 10/100 ETHERNET**' port and the 9-pin serial '**J1 | COM 1**' port located on the MBT-5000A rear panel.

Do these steps:

- Download the firmware update archive file via the Internet to the User PC.
- Use Windows Command-line to transfer, via File Transfer Protocol (FTP), the extracted firmware files from the User PC to the MBT-5000A standby firmware image.
- Use the MBT-5000A HTTP (Web Server) Interface to configure the converter to operate using the updated firmware image.

4.1.1 About Firmware Files Naming, Versions, and Formats

CEFD's Web site catalogues its firmware update files by product type (e.g., modem, converter, etc.) and specific model/optional configuration. The hyperlinks appear as per the example to the right. In this example, the **F000098X_V###** firmware download hyperlink is depicted, where 'X' denotes the revision letter, and ### represents the firmware version.

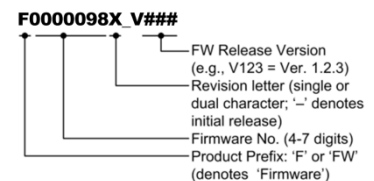

The firmware download files are available from CEFD in two archive file formats: *.exe (self-extracting) and *.zip (compressed). Some firewalls will not allow downloading of *.exe files; in this case, download the *.zip file instead. If applicable, one version prior to the current release is also available for download.



For additional help with "zipped" file types, refer to the help files provided with the "PKZIP for Windows", "WinZip", or "ZipCentral" file archiving programs. "PKZIP for Command-line" is not supported due to file naming conventions.

To verify the correct firmware number, see Step 2(D) in **Sect. 4.3.1 Getting Started: Prepare for the Firmware Download.**

4.2 Getting Started: Prepare for the Firmware Download

1. First, identify the MBT-5000A assigned Ethernet Traffic IP Address and the firmware information (number/revision letter/version number).

User-supplied items needed:

- A Microsoft Windows-based PC, equipped with available serial and Ethernet ports; a compatible Web browser (e.g., Internet Explorer); and a terminal emulator program (e.g., Tera Term or HyperTerminal).
- A 9-pin serial cable and a standard CAT5 Ethernet cable to connect the MBT-5000A to the user PC.

- a. Use an Ethernet hub, switch, or direct cable connection to connect the MBT-5000A rear panel '**J9 | 10/100 ETHERNET**' port to an Ethernet port on the User PC.

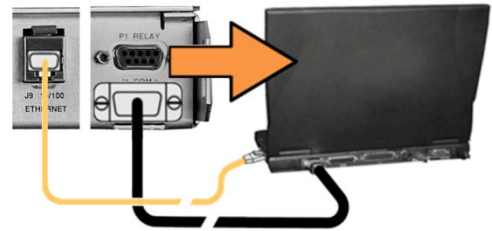

- b. Use the 9-pin serial cable to connect the MBT-5000A rear panel '**J1 | COM 1**' port to a serial port on the User PC.

- c. On the PC, open the terminal emulator program. Configure the program serial port communication and terminal display settings. The factory default operation requires these settings:

- **38500 bps (Baud Rate)**
- **8 Data Bits**
- **1 Stop Bit**
- **Parity = NO**
- **Port Flow Control = NONE**
- **Display New line Rx/Tx: CR**
- **Local Echo = ON**



Refer to your terminal emulator program HELP feature or user guide for operating and configuration instructions.

- d. On the MBT-5000A, turn on the power.

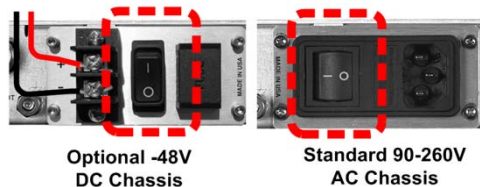

- e. Identify the Ethernet Traffic (M&C) IP Address and firmware information using one of the following methods:

Using the MBT-5000A Serial Remote Interface (via the User PC / terminal emulator program):

- Firmware Info – Use the <0/SWR? (condensed) or <0/FRW? (detailed) remote query.
- Ethernet Traffic IP Address – Use the <0/IPA? remote query.

Using the MBT-5000A Front Panel menus:

- Ethernet IP Address – Use the CONFIG: Remote → Ethernet → Address menu branch, as shown in this example:

Ether IP Address/Range:
192.168.001.011/24 (◀ ▶ ▲ ▼)

- Firmware Info – Use the SELECT: UTILITY → Firmware → Info → Image#1 or Image#2 → Bulk menu branches, as shown in this example:

Bulk:FW-000303
2.1.X MM/DD/YY

Using the MBT-5000A HTTP Interface (via the User PC Web Browser – use of this interface indicates the Ethernet Traffic IP Address is already known):

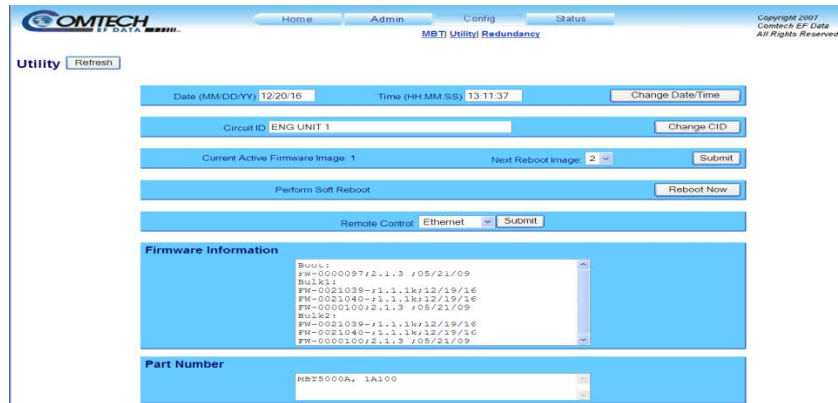

- **Firmware Info** – Use the “Firmware Information” section of the ‘Config | Utility’ page, as shown in this example:

2. Next, create a temporary folder (subdirectory) on the user PC for the firmware archive download. There are several ways to create a temporary folder on a Windows-based PC:



- Drive letter “c:” is used in these examples. Any valid, writable drive letter can be used.
- Typical for all tasks: Type the command without quotes, and then press Enter to execute.

- a. Use the Windows Desktop to create and rename the temporary folder.

- Right-click anywhere on the desktop to open the popup submenu, and then select **New > Folder** to create a temporary folder on the desktop.
- Right-click on the new folder and then select “**Rename**” from the popup submenu. Rename this folder to “MBT5000A” or some other convenient, unused name.



- b. Use Windows Explorer to create and rename the temporary folder.

- Select File > New > Folder to create a temporary folder. This creates the new folder in the active folder.
- Right-click the “New Folder” folder name, and then rename this folder to “MBT5000A” or some other convenient, unused name:

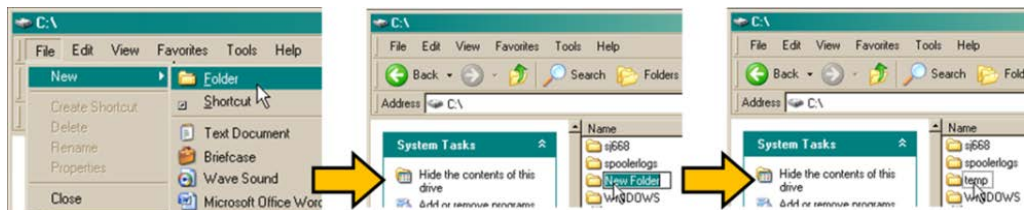

- c. Use the 'Run' and 'Browse' windows to create and rename the temporary folder.
- Select **[Start]** on the Windows taskbar, and then click the **Run...** icon. This opens the 'Run' window.
 - Click **[Browse]** in the 'Run' window. This opens the 'Browse' window.
 - Click the **Create New Folder** icon in the 'Browse' window. This creates the new folder.
 - Right-click the "New Folder" folder name, and then rename this folder to "**MBT5000A**" or some other convenient, unused name:

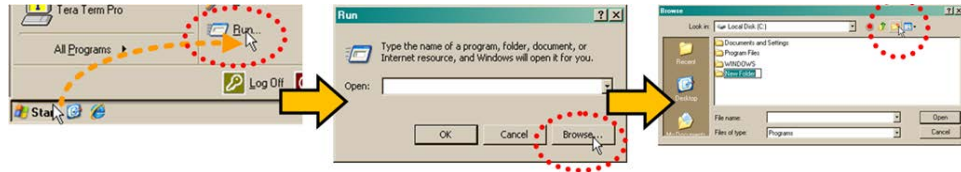

- d. Use Windows Command-line to create the temporary folder.

- Click **[Start]** on the Windows taskbar, and then click the **Run...** icon (or, depending on Windows OS versions *prior* to Windows 95, click the **MS-DOS Prompt** icon from the Main Menu).
- Open a **Command-line window...**
 - For Windows 95 or Windows 98, type "command" (or, for any Windows OS versions later than Windows 98, type "cmd" or "command"):

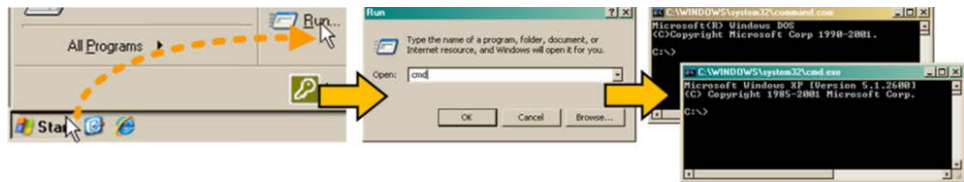

- Alternately, from **[Start]**, select **All Programs > Accessories > Command Prompt**.
- Finally, from the Command-line prompt (c:\>), type "**mkdir MBT5000A**" or "**md MBT5000A**" (*mkdir* and *md* stand for *make directory*), and then click **[OK]**:

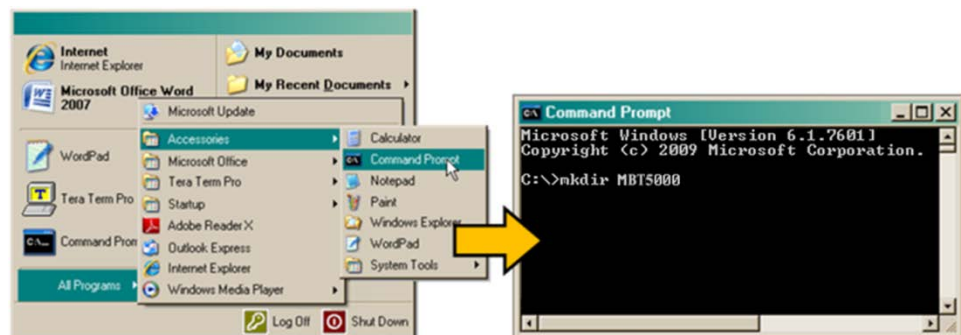

There should now be a temporary folder created and available for placement of the firmware file download.

4.2.1 Download and Extract the Firmware Update

1. First, download the firmware update file from the CEFD Web site:
 - a. Go online to www.comtechefdata.com.
 - b. On the **Main** page – under Support Information or the Support tab, select the **Software Downloads** hyperlink.
 - c. On the **Software Downloads** page – click **Download Flash and Software Update Files**.
 - d. On the **Flash & Software Update Files** page – select the **(Select a Product Line) Converters** hyperlink.
 - e. On the **Converters** product page – select the **MBT-5000A** product hyperlink;
 - f. Select the appropriate firmware archive EXE or ZIP file download hyperlink.
 - g. Download the archive file to the temporary folder.
 - Once the EXE or ZIP hyperlink is selected, the **'File Download'** window opens and prompts selection of **[Open]** or **[Save]**:
 - Click **[Open]** to turn over file extraction to the user-supplied utility program. Be sure to extract the firmware files to the “MBT5000A” folder created earlier.
 - Click **[Save]** to open the **'Save As'** window. Be sure to select and **[Save]** the archive *.exe or *.zip file to the “MBT5000A” folder created earlier.
 - Otherwise, click **[Cancel]** to quit and exit the file download process.

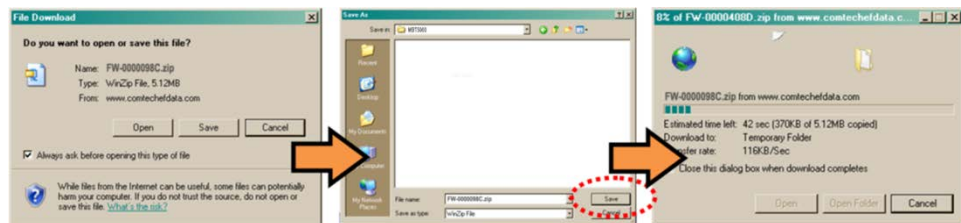

2. Next, extract the firmware files from the archive file.
 - (If not already done with **File Download > [Open]**) Extract the firmware files from the downloaded *.exe or *.zip archive file with the user-supplied utility program:
 - Double-click on the archive file name, and then follow the prompts provided by the user-supplied utility program. Extract, at a minimum, two files (where 'X' represents the revision letter and '#.#.#' represents the version number):
 - F0000098X-#.#.#.bin** – the Firmware Bulk image file, and
 - ReleaseNotes_MBT5000A_#.#.#.pdf** – the Firmware Release Notes PDF file.

3. Confirm availability of the firmware files in the temporary folder. There are several ways you may view the contents of the temporary folder on a Windows-based PC:
 - a. From the Windows Desktop:
 - Double-left-click the “MBT5000A” folder saved to the Windows Desktop.
 - Use Windows Explorer to locate, and then double-left-click the “MBT5000A” folder.
 - Use the Browse window ([**Start**] > ...**Run** > [**Browse**]) to locate, and then double-click the “c:\MBT5000A” folder.
 - b. Using Command-line:
 - Type “**cd c:\MBT5000A**” at the Command-line prompt to change to the temporary directory created earlier using Command-line.
 - Type “**dir**” to list the files extracted to the temporary directory from the downloaded archive file.

The firmware files have been successfully downloaded and are now available for transfer to the MBT-5000A.

4.2.2 Perform the Ethernet FTP Upload Procedure



To proceed with the firmware update procedure, assumptions are made that:

- You have connected the MBT-5000A to a user-supplied, Windows-based PC, and:
 - The User PC serial port is connected to the MBT-5000A 'J1 | COM 1' port with a standard user serial cable.
 - The User PC Ethernet port is connected to the MBT-5000A 'J9 | 10/100 ETHERNET' port with a user-supplied hub, switch, or direct Ethernet cable connection.
 - The User PC is running a terminal emulation program (for operation of the MBT-5000A Serial Interface) and a compatible Web browser (for operation of the MBT-5000A HTTP Interface).
 - You have identified the MBT-5000A Ethernet Traffic IP Address and firmware using either the MBT-5000A Serial Interface, or the MBT-5000A HTTP Interface 'Admin | Access' and 'Status | Status' pages, respectively.
 - You have downloaded or otherwise received from CEFD the latest firmware files, and they are available on the user PC in an accessible temporary folder.
1. Use Command-line to send a "PING" command to confirm proper connection and communication between the user PC and the MBT-5000A:
 - Type "**ping xxx.xxx.xxx.xxx**" at the Command-line prompt (where '**xxx.xxx.xxx.xxx**' denotes the unit Ethernet Traffic IP Address).
 - The response should confirm whether the unit is properly connected and communicating.
 2. Use Command-line to transfer (FTP) the files from the user PC to the MBT-5000A:
 - Type "**ftp xxx.xxx.xxx.xxx**" (where '**xxx.xxx.xxx.xxx**' denotes the unit Ethernet Traffic IP Address).
 - If prompted for the admin username and password, press **Enter** for both.
 - Type "**bin**" to set the binary transfer mode.
 - Type "**prompt**" and "**hash**" to facilitate the file transfer.
 - Type "**put FW-000098X_MBT_#_#_#.bin bulk:**" (where "X" denotes the revision letter, and "#_#_#" is the firmware version number) at the Command-line prompt, without quotes, to begin the file transfer.



The destination "bulk" must be all lower-case.

- Wait for approximately one minute while the transfer takes place. Once the file transfers, Command-line displays the upload result, similar to:

200 Port command okay

150 Opening data connection.

226 File received OK – XXXXXXX bytes in XX.XXX sec

ftp: XXXXXXX bytes sent in XX.XXSeconds XXX.XXXKbytes/sec.



In the event you receive the “Connection closed by remote host.” message, wait another minute before continuing. The firmware upload sometimes takes longer than the FTP client allows.

- As the upgrade process continues, the converter front panel displays:

Programming APP Flash... Please wait

Programming main FPGA... Please wait

- Type "bye" to terminate the FTP session, and then close the Command-line window.
3. Use the converter front panel menus, the MBT-5000A HTTP Interface ‘**Status | Status**’ page, or issue the Serial Remote Interface <0/SWR? or <0/FRW? query as shown previously to verify that the PC-to-Unit FTP file transfer was successful.
 4. Use the converter front panel menus or the the MBT-5000A HTTP Interface to select the desired firmware image to boot from:
 - a. Using the front panel menus: To select the desired Firmware Image, be sure you are first in **LOCAL** mode (**SELECT: Config → Remote → Local**). Then, go to the **SELECT: Utility → Firmware → Select** branch. Use the ◀ ▶ arrow keys to select the **Next Reboot Image** as #1 or #2. Press **ENTER** when done.
 - b. Using the MBT-5000A HTTP Interface ‘**Config | Utility**’ page: Use the drop-down list to select the **Next Reboot Image** as 1 or 2. Click [**Submit**] to save.
 5. Cycle power to reboot the MBT-5000A:
 - **On the MBT-5000A rear panel:** Turn off/disconnect the power source.
 - **Using the MBT-5000A HTTP Interface ‘Config | Utility’ page:** Click [**Reboot Now**] to soft reboot the converter.
 - Upon reboot, the converter front panel “splash” screen should verify that the new firmware version is active, as shown in this example:

MBT-5000A

Version: #.#.# SN #####

6. To load the second Firmware Image, use the converter front panel or the MBT-5000A HTTP Interface ‘**Config | Utility**’ page to configure the target Image (1 or 2) as the **Current Active Firmware Image**, and then repeat Steps 2 through 5.

The MBT-5000A is now operating with its latest firmware. The firmware update process is now complete.

Chapter 5. FRONT AND REAR PANEL OPERATION

5.1 Overview

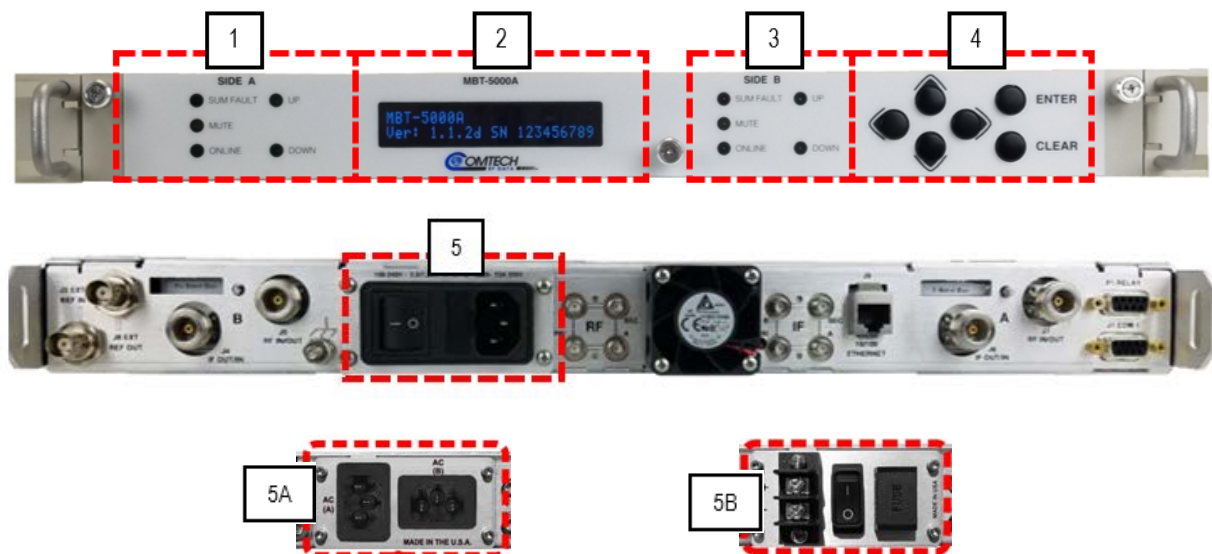

Figure 5-1. MBT-5000A Front and Rear Panel Views (Redundant Unit Shown)

Feature	Description	Function
Front Panel	1 'Side A' Light Emitting Diode (LED) Indicators	This group of LEDs indicates, in a summary fashion, the status of Converter 'A'.
	2 Vacuum Fluorescent Display (VFD)	The VFD is an active display showing two lines of 24 characters each. It produces a blue light with adjustable brightness. Nested menus display all available options and prompt you to carry out a required action.
	3 'Side B' LED Indicators	This group of LEDs indicates, in a summary fashion, the status of Converter 'B'.
	4 Keypad	The keypad comprises six individual keyswitches. These keys have a positive 'click' action, which provides tactile feedback. Use this keypad to enter data in response to messages and prompts shown on the VFD.
Rear Panel	5 Standard 90-260V AC Power Interface 5A Optional Dual Entry AC Power Interface (Redundancy Units Only) 5B Optional -48V DC Power Interface	The Power Switch is an integral component of the standard AC Power Interface, the optional dual entry AC Power Interface, and the optional DC Power Interface. It is used to turn the unit ON / OFF.

5.1.1 Switch Power On (Rear Panel)



- Chapter 2. INSTALLATION
- Chapter 3. REAR PANEL CONNECTIONS

Before you turn on power to the unit, make sure that installation is complete, and verify that the MBT-5000A is connected to the proper prime power source, RF Input, and RF Output. Refer to **Chapter 3. REAR PANEL CONNECTIONS** for instruction on how to operate the rear panel.

Switch on the unit and verify the cooling fan is operational, the LED indicators illuminate as expected, and the Vacuum Fluorescent Display is readable.

5.1.2 LED Indicators

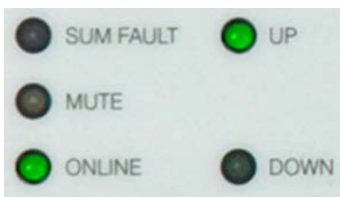

The operational condition of the MBT-5000A is represented by two sets of five front panel LED indicators – one set each for **Side A** and **Side B**.



LED	STATE	WHEN LIT, THE DESIGNATED SIDE...
SUM FAULT	Red	...has active faults.
MUTE	Amber	...is in Mute Mode.
ONLINE	Green	...is operational.
UP	Green	...is operating as an Up Converter.
DOWN	Green	...is operating as a Down Converter.

5.1.3 Keypad



The keypad has an auto-repeat feature. When you hold down a key for more than one second, the key action repeats, automatically, at the rate of 15 keystrokes per second. This is particularly useful when editing numeric field with many digits, such as frequency or data rate.

The keypad functions as follows:

Key	Description
 ENTER	Use this key to display the nested menu for a selected function, or to execute (save) a configuration change.
 CLEAR	Use this key to cancel a configuration change that has not been executed using ENTER . Press CLEAR to return to the previous menu screen.
(Left, Right)	Use these keys to navigate between available selections, or to move the cursor position, on any menu screen.
(Up, Down)	Use these keys primarily to change the alphanumeric selection (i.e., numbers for configuration data, letters for text strings) at the current cursor position, or to scroll through pre-defined parameter settings that the MBT-5000A may provide at the current cursor position.

5.1.4 Vacuum Fluorescent Display (VFD)



The MBT-5000A features a VFD, which is an active display showing two lines of 24 characters each. It produces a blue light, the brightness of which can be controlled by the user. Compared to a Liquid Crystal Display (LCD), it provides superior viewing characteristics and does not suffer problems of viewing angle or contrast.

On most menu screens, a flashing solid block cursor blinks at a once-per-second rate. This indicates the currently selected item, digit, or field. Where it might obscure the item under edit (e.g., a numeric field), the solid block cursor automatically changes to an underline cursor.

5.1.4.1 Screen Saver

If you were to leave the operating unit displaying the same screen for weeks at a time, the VFD could become 'burnt' with this image. To prevent such burn-in, a screen saver feature activates after 1 hour. The screen saver message scrolls from right to left across the screen, and then wraps around. The user-configurable unit label, or Circuit ID, displays on the VFD top line, while the bottom line displays "**Press any key...**". Press any key to return to the previous screen.

5.1.4.2 Opening Screen

This VFD "Home" screen displays once you apply power to the unit. When you turn on the prime power, and after bootup, the VFD displays the converter model number (i.e., 'MBT-5000A'), the installed firmware version number, and the serial number factory-assigned to the unit in use.

Access this opening screen at any time from within the menu structure by pressing the **CLEAR** key repeatedly. Otherwise, press any key to access the **SELECT: (Main)** menu screen.

5.2 Front Panel Operation

Figure 5-2 shows the hierarchal structure of the MBT-5000A menu tree from the **SELECT: (Main)** menu on down. The structure helps to prevent invalid command entry.

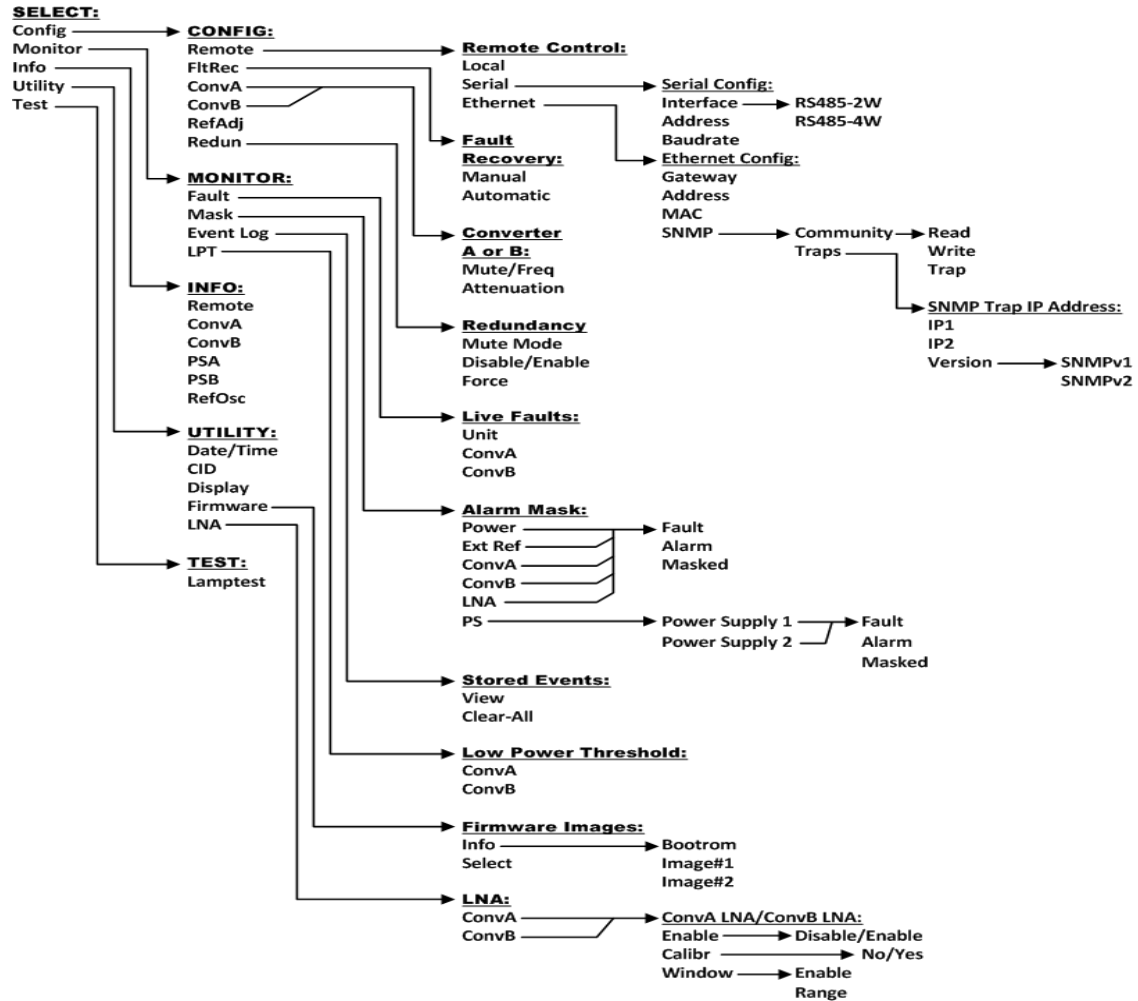

Figure 5-2. MBT-5000A Front Panel Menu Tree (Firmware Ver. 1.1.1)

5.2.1 SELECT: (Main) Menu

```
SELECT: Config Monitor
Info Utility Test (◀▶ E)
```

Press **ENTER** or **CLEAR** to immediately access the **SELECT:** menu screen from the opening screen. From any nested menu, press **CLEAR** repeatedly until this screen reappears. Then, use the ◀▶ arrow keys to select from the menu branch choices shown.



Unless otherwise noted, all menu functions are typical for use with Converter (Side) A and Converter (Side) B operation.

The menu branches available from the **SELECT: (Main) Menu** are as follows:

Menu Branch	Sect	Function
Config	5.2.2	(Configuration) Used to fully configure the MBT-5000A.
Monitor	5.2.3	Used to monitor the alarm status of the unit, to view the log of stored events, and to display the Receive Parameters screen.
Info	5.2.4	(Information) Used to view information on the unit, without having to go into configuration screens.
Utility	5.2.5	Used to perform miscellaneous functions, such as setting the Real-time clock, adjusting the display brightness, etc.
Test	5.2.6	Used to run diagnostics tests on the front panel LEDs and VFD to verify operation.

5.2.2 SELECT: Config (Configuration) Menu Branches

CONFIG: Remote FltRec
ConvA ConvB RefAdj Redun

Use the ◀ ▶ arrow keys to select from the submenu choices shown, and then press ENTER.

The submenus available from the SELECT: Config (Configuration) menu branch are as follows:

Submenu	Sect	Function
Remote	0	(Remote Control) Used to define whether you control the unit locally or remotely, and identifies the unit address, interface type, and rate and format of the baud parameters.
FltRec	5.2.2.2	(Fault Recovery) Used to configure Fault Recovery in <i>Auto</i> (AFR) or <i>Manual</i> mode.
ConvA ConvB	5.2.2.3	(Converter 'A' or 'B') Displays the current configuration of the selected converter, including the frequency, attenuation, and slope.
RefAdj	5.2.2.4	(Reference Oscillator Adjustment) Used to adjust the reference oscillator.
Redun	5.2.2.5	(Redundancy) Used to identify the redundancy state and mode (see Appendix B. MBT-5000A REDUNDANCY OPERATION for further information).

5.2.2.1 CONFIG: Remote (Remote Control) Menus

```
Remote Control: Local
Serial Ethernet (< ▶ E)
```

Use the < ▶ arrow keys to select **Local**, **Serial**, or **Ethernet**, and then press **ENTER**.

5.2.2.1.1 Remote Control: Local

When you select **Local** mode, this disables remote control, although remote monitoring is still possible.

5.2.2.1.2 Remote Control: Serial

```
Serial Config: Interface
Address Baudrate
```

Use the < ▶ arrow keys to select **Interface**, **Address**, or **Baudrate**, and then press **ENTER**.

Serial Config: Interface

```
M&C Bus Interface: RS232
RS485-2W RS485-4W (< ▶ E)
```

Use the < ▶ arrow keys to select **RS232**, **RS485-2W** (2-wire), or **RS485-4W** (4-wire), and then press **ENTER**.

Serial Config: Address

```
Remote Address: 0001
(< ▶ ▲ ▼ E)
```

The valid range of addresses is from 1 to 9997. Use the < ▶ arrow keys to select the digit to edit, and then use the ▼ ▲ arrow keys to change the value of that digit. Press **ENTER** when done.

Serial Config: Baudrate

```
Local M&C Bus Baud Rate:
19200 Baud (▲ ▼ E)
```

To set the baud rate of the remote M&C bus connection between the unit and the user PC: Use the ▲ ▼ arrow keys to select **2400**, **4800**, **9600**, **19200**, and **38400**. Press **ENTER** when done.



*The asynchronous character format is **FIXED** at 8 data bits, 1 stop bit, no parity (8-N-1).*

5.2.2.1.3 Remote Control: Ethernet

```
Ethernet Config: Gateway
Address MAC SNMP (< ▶ E)
```

Use the ◀ ▶ arrow keys to select the parameter to configure – **Gateway, Address, MAC, or SNMP** – then press **ENTER**.

Ethernet Config: Gateway

```
Ethernet IP Gateway:
192.168.001.002 (< ▶ ▲ ▼)
```

To edit the IP Gateway Address for the Ethernet M&C port for this unit, use the ◀ ▶ arrow keys to first select the digit to edit, and then use the ▼ ▲ arrow keys to edit the value of that digit. Press **ENTER** when done.

Ethernet Config: Address

```
Ether IP Address/Range:
192.168.001.002/24 (< ▶ ▲ ▼)
```

To edit the IP Address and Range for the Ethernet M&C port for this unit, use the ◀ ▶ arrow keys to first select the digit to edit, and then use the ▼ ▲ arrow keys to edit the value of that digit. Press **ENTER** when done.

Ethernet Config: MAC

```
M&C Port MAC Address:
00-06-B0-00-01-06
```

This *read-only* menu shows the unit MAC address. Once the MAC address has been noted, press **ENTER** or **CLEAR** to exit this menu.

Ethernet: SNMP

```
SNMP:
Community Traps (< ▶ E)
```

Use the ◀ ▶ arrow keys to select the parameter to configure: **Community** or **Traps**.

SNMP: Community

```
SNMP Community: Read
Write Trap (◀ ▶ E)
```

Use the ◀ ▶ arrows keys to select **Read**, **Write**, or **Trap**, and then press **ENTER**.

SNMP: Community → Read

```
Read Community: (◀ ▶ ▲ ▼ E)
public
```

SNMP: Community → Write

```
Write Community:(◀ ▶ ▲ ▼ E)
private
```

SNMP: Community → Trap

```
Trap Community:(◀ ▶ ▲ ▼ E)
comtech
```

To edit the SNMP Read, Write, or Trap Community strings: First, use the ◀ ▶ arrow keys to select a character to edit, and then use the ▲ ▼ arrow keys to edit that character. Note that only the first 20 characters on the bottom line are available.

All printable ASCII characters are available with the exception of the backslash '/' (ASCII code 92) and tilde '~' (ASCII code 126).

Press **ENTER** once you compose the string – the MBT-5000A removes all trailing spaces from the string upon entry.

SNMP: Traps

```
SNMP Trap IP Address:
IP1 IP2 Version
```

Use the ◀ ▶ arrow keys to select IP1, IP2, or Version, and then press **ENTER**.

SNMP Trap IP Address: IP1 or IP2

```
Trap IP #1:
000.000.000.000(◀ ▶ ▲ ▼ E)
Trap IP #2:
000.000.000.000(◀ ▶ ▲ ▼ E)
```

To edit the Trap Destination IP Addresses: First, use the ◀ ▶ arrow keys to select the digit to edit, and then use the ▼ ▲ arrow keys to edit the value of that digit. Press **ENTER** when done.



If both Trap IP Addresses are 000.000.000.000, it means Traps are disabled.

SNMP Trap IP Address: Version

```
Trap Version:  
SNMPv1 SNMPv2 (< ▶ E)
```

Use the ◀ ▶ arrow keys to select the trap version – **SNMPv1** or **SNMPv2** – and then press **ENTER**.

5.2.2.2 CONFIG: FltRec (Fault Recovery) Menu

```
Fault Recovery: Manual  
Automatic (< ▶ E)
```

Use the ◀ ▶ arrow keys to select **Manual** or **Automatic**, and then press **ENTER**.

5.2.2.3 CONFIG: ConvA or ConvB (Converter 'A' or Converter 'B') Menus

```
Converter X  
Mute/Freq Attenuation
```

Where 'X' is the selected converter – **Converter (Side) A** or **Converter (Side) B** – use the arrow keys to select **Mute/Freq** or **Attenuation**, and then press **ENTER**.

5.2.2.3.1 Converter X: Mute/Freq

For either side – A or B – the display differs depending on whether the selected module is a BUC or BDC.

For example, if you select Converter A and it is a BUC:

```
CONFIG CnvA:  
Tx=On
```

Use the ▼ ▲ arrow keys to select **Tx** as either **On** or **Off** (muted), and then press **ENTER**.

Similarly, if you select Converter B and it is a BDC:

```
CONFIG CnvB:  
Rx=On Freq=01980.000MHz
```

Use the ▼ ▲ arrow keys to select **Rx** or **Freq**. Note that **Freq** displays only when the module is a Ku-Band BDC unit.

Use the ▼ ▲ arrow keys to select **Rx** as either **On** or **Off** (muted), and then press **ENTER**.

To edit the frequency, use the ◀ ▶ arrow keys to first select the digit to edit, and then use the ▼ ▲ arrow keys to edit the value of that digit. Press **ENTER** when done.

5.2.2.3.2 Converter X: Attenuation

For either side – A or B – and typical whether the selected module is a BUC or a BDC:

```
CONFIG CnvX: Offst=+2.00
Attenuation = 00.00 dB
```



Offst (Offset) will display only if the module is an offline unit.

5.2.2.4 CONFIG: RefAdj (Reference Oscillator Adjustment) Menu

```
Reference Frequency
Adjust: 087
```

Use this menu for the reference oscillator adjustment. Use the ◀ ▶ arrow keys to first select the digit to edit, and then use the ▼ ▲ arrow keys to edit the value of that digit. Press **ENTER** when done.

The default Reference Frequency tuning adjustment is 087, with allowable values from 0 to 255.

5.2.2.5 CONFIG: Redun (Redundancy) Menus

1:1 Redundancy is an optional feature for the MBT-5000A. When you attempt to select this menu branch, but your MBT-5000A is configured as a standalone up/down converter system (e.g., a non-redundant configuration, where a BUC is installed in **Side A**, and a BDC is installed in **Side B**) the following message displays:

```
Redundancy is Disabled.
```

Otherwise, when selecting this menu branch and your MBT-5000A is properly configured as an up or down redundant converter system (e.g., where either two BUCs or two BDCs are installed), the Redundancy menu branch appears as follows:

```
Redundancy:
Disable/Enable Force
```

Use the ◀ ▶ arrow keys to select **Disable/Enable** or **Force**, and then press **ENTER**.

5.2.2.5.1 Redundancy Mode: Disable/Enable

```
Redundancy Mode:
Disable Enable
```

Use the ◀ ▶ arrow keys to **Enable** or **Disable** redundant operations, and then press **ENTER**.

5.2.2.5.2 Redundancy Mode: Force



Appendix B. MBT-5000A REDUNDANCY OPERATION

Press ENTER to Force
Converter A to Standby

As the display instructs, press **ENTER** to force the redundant unit into standby mode.

5.2.3 SELECT: Monitor Menu Branch

```
Monitor: Faults Mask
Event-Log LPT
```

Use the ◀ ▶ arrow keys to select from the submenu choices shown, and then press ENTER.

The submenus available from the SELECT: Monitor menu branch are as follows:

Submenu	Sect	Function
Faults	5.2.3.1	Displays the active faults for the base unit and the converters.
Mask	5.2.3.2	Used to configure Alarm Mask (MSK) conditions.
Event-Log	5.2.3.3	Used to displays stored events, and to clear the events.
LPT	5.2.3.4	(Low Power Threshold) Used to configure Low Power Threshold.

5.2.3.1 Monitor: Faults

```
Live Faults: Unit ConvA
ConvB (◀ ▶ E)
```

Use the ◀ ▶ arrow keys to select **Unit**, **ConvA**, or **ConvB**, and then press ENTER. If you select **Unit**, the highest level fault for the base unit appears. If no Unit faults exist, the message “**Unit Fault: No Errors**” displays.

Press ENTER to return to the previous menu.

If you select **ConvA** or **ConvB**, the highest fault for that converter appears. If no Converter faults exist, the message “**ConvX Fault: No Errors**” (where **ConvX** means **ConvA** or **ConvB**) displays.

Press ENTER to return to the previous menu.

5.2.3.2 Monitor: Mask

```
Alarm Mask: Power ExtRef  
ConvA ConvB LNA PS (◀▶E)
```

Use the ◀ ▶ arrow keys to select **Power** (when optionally configured for Power Monitoring), **ExtRef**, **ConvA**, **ConvB**, **LNA**, or **PS**, and then press **ENTER**.

For each menu selection, three typical options are available. Using the **ExtRef** menu as an example:

```
Ext Ref Lock Detect:  
Fault Alarm Masked (◀▶E)
```

Use the ◀ ▶ arrow keys to select **Fault**, **Alarm**, or **Masked**, and then press **ENTER** to return to the previous menu.



If Power Monitoring is not supported when you select Power alarm masking, the following message displays:

```
This Converter Does NOT  
Support Power Monitor.
```

5.2.3.2.1 Out-of-Range Power Supply Masking Using the PS Submenu

```
Power Supply 1:  
Power Supply 2: (◀▶E)
```

Use this submenu to configure how out-of-range power supply events are shown on the front panel **Side A** and **Side B SUM FAULT** LEDs, and the Summary Fault Relay.

Select **Power Supply 1** or **Power Supply 2**, and then press **ENTER**.

Alarm Mask: PS → Power Supply X

Power Supply X:
Fault Alarm Masked (◀▶E)

Use the ◀▶ arrow keys to select **Fault**, **Alarm**, or **Masked**, and then press **ENTER**. Note the following:

Selection	State
Fault	Both SUM FAULT LEDs are lit and the Summary Fault Relay is tripped to the Fault position.
Alarm	Both SUM FAULT LEDs are lit, but the Summary Fault Relay position is not affected
Masked	Neither the SUM FAULT LEDs nor the Summary Fault Relay are affected.

If all power supplies in the chassis are out of range, then both **SUM FAULT** LEDs are lit (if able) and the **Summary Fault Relay** is tripped to the **Fault** position.



Power Supply 2 is typically available when the optional Dual Entry Module AC Power is installed on the optional redundant chassis. Most standalone (i.e., single-thread or non-redundant) chassis will not have this AC power option. For any chassis containing a single power supply, you must set Power Supply 2 as “Masked” to prevent the occurrence of misleading alarms.

5.2.3.3 Monitor: Event-Log (Stored Events)

Stored Events: View
Clear-All (◀▶E)

Use the ◀▶ arrow keys to select **View** or **Clear-All**, and then press **ENTER**.

5.2.3.3.1 Stored Events: View

Log015 05/23/08 09:27:15
Fault – FPGA Checksum

Use the ▼▲ arrow keys to scroll backwards or forwards through the entries in the event log.

The event log can store up to 300 events. When a fault condition occurs, the MBT-5000A timestamps it and puts it into the log. Similarly, when the fault condition clears, MBT-5000A records this change, as shown per the following example:

Log015 05/23/08 10:45:35
Clear – FPGA Checksum

Press **ENTER** or **CLEAR** to return to the previous menu.

5.2.3.3.2 Stored Event: Clear-All

```
Clear all Stored Events?  
No Yes (◀▶ E)
```

As prompted, use the ◀ ▶ arrow keys to choose **No** or **Yes**, and then press **ENTER**. If you select **Yes**, the event log is cleared and the user is returned to the previous menu. However, if faults remain present at this time, they MBT-5000A re-stamps them and generates new log entries.

5.2.3.4 Monitor: LPT (Low Power Threshold)

```
Low Power Threshold:  
ConvA ConvB
```

When the MBT-5000A is optionally configured, use this menu to set the threshold, in dBm, for the low forward power alarm/fault. If the forward power drops below the specified value while the unit is online, is unmuted, and PLL is locked, the MBT-5000A will indicate the alarm/fault.

Use the ◀ ▶ arrow keys to select **ConvA** or **ConvB**, and then press **ENTER**. Where **'X'** is the selected converter – **Converter (Side) A** or **Converter (Side) B**:

```
ConvX LPT = +00.0 dBm
```

Use the ◀ ▶ arrow keys to first select the digit to edit, and then use the ▼ ▲ arrow keys to edit the value of that digit.

Note the following:

- The valid range for this parameter is from the unit's specific P1dB power level to P1dB *minus* 19 dB.
For example: For a unit with +12 dBm at P1dB, the range would be +12.0 to -7 dBm.
- The default value is -20.0 dBm. Setting the parameter to this default value effectively disables the threshold.
- If Power Monitoring is not supported, and you select ConvA or ConvB, the following message displays:

```
This Converter Does NOT  
Support Power Monitor.
```

Press **ENTER** when done or **CLEAR** to return to the previous menu.

5.2.4 SELECT: Info (Information) Menu Branch

```
INFO:Remote ConvA ConvB
PSA PSB RefOsc EOD
```

The Info menu branch displays *read-only* information on the current configuration of the unit. Use the ◀ ▶ arrow keys to select from the submenu choices shown, and then press ENTER.

The submenus available from the SELECT: Info (Information) menu branch are as follows:

Submenu	Sect	Function
Remote	5.2.4.1	(Remote Control) Displays when the unit is in Local or Remote mode and gives details of the interface type selected, etc.
ConvA ConvB	5.2.4.2	Displays the temperature and RF power for Converter 'A' or Converter Unit B.
PSA PSB	5.2.4.3	Displays the 19V, and 5V power supplies for Power Supply 1 or 19V, and 5V power supplies for Power Supply 1.
Ref	5.2.4.4	Displays the raw voltage of the voltage tuning monitor, and the external reference status.
MC	5.2.4.5	Displays the 8V, 12V and 15V Voltages generated on the M&C.
EOD	5.2.4.6	Displays the base Equipment Odometer in hours.

5.2.4.1 INFO: Remote (Remote Control)

This screen displays when the unit is in **Local** or **Remote** mode, and gives details of the interface type selected, etc. For example:

```
Remote M&C: 100BaseTx
IP Addr: 192.168.001.004
```

Press **ENTER** or **CLEAR** to return to the previous menu.

5.2.4.2 INFO: ConvA (Converter 'A') or ConvB (Converter 'B')

Where 'X' is the selected converter – Converter (Side) A or Converter (Side) B: This screen displays the module temperature and, depending on the optional configurations:

- For BUCs only, **RF Power**
- For BDCs only, **LNA Current**

For example:

```
ConvX: Temp = +34.1 C
RF Power = +10.0 dBm
```

```
ConvX: Ka-Band BDC
RF: 19200 - 20200
```

```
IF: 01000 - 02000
EOD: 000045
```

Press **ENTER** or **CLEAR** to return to the previous menu.

5.2.4.3 INFO: PS1 or PS1 (Power Supply '1' or Power Supply '2')

Where 'X' is the selected converter – Converter (Side) A or Converter (Side) B: This screen displays the 19V, 7.8V, and 5V values for PSA (Power Supply 'A'), and the 19V, 12V, 15V and 5V values for PSB (Power Supply 'B'). For example:

```
Power Supply A: 19V=19.2
5V=05.6 7.8V=08.3
```

```
Power Supply B: 19V=19.2
5V=05.6 12V=12.1 15V=15.4
```

Press **ENTER** or **CLEAR** to return to the previous menu.

5.2.4.4 INFO: Ref (Reference Oscillator)

This screen displays the raw voltage of the voltage tuning monitor, and the external reference status. For example:

```
Ref Osc: Vtune = 04.7
Ext Ref: N/A
```

Press **ENTER** or **CLEAR** to return to the previous menu.

5.2.4.5 INFO: MC (Voltage generated on the M&C)

This screen displays the 8V, 12V and 15V values. For example:

```
MC: 8V=8.2
12V=12.2 15V=15.4
```

Press **ENTER** or **CLEAR** to return to the previous menu.

5.2.4.6 INFO: EOD (Equipment Odometer)

This screen displays the Base Equipment Odometer, in hours. For example:

EOD 000047

Press **ENTER** or **CLEAR** to return to the previous menu.

5.2.5 SELECT: Utility Menu Branch

UTILITY: Date/Time CID

Display Firmware LNA

Use the ◀ ▶ arrow keys to select from the submenu choices shown, and then press ENTER.

The submenus available from the SELECT: Utility menu branch are as follows:

Submenu	Sect	Function
Date/Time	5.2.5.1	Edits the Real-Time Clock time and date settings
CID	5.2.5.2	Edits the 24-character Circuit ID string.
Display	5.2.5.3	Adjusts the brightness level of the VFD.
Firmware	5.2.5.4	Displays the installed internal firmware and permits user the boot using a selected firmware image.
LNA	5.2.5.5	Permits control of any LNAs configured for use with the MBT-5000A.

5.2.5.1 UTILITY: Date/Time (Set Real-time Clock)

Edit Real-Time Clock:

12:00:00 04/24/14(◀▶▲▼E)

To edit the time and date settings for the real-time clock, use the ◀ ▶ arrow keys to first select the digit to edit, and then use the ▼ ▲ arrow keys to edit the value of that digit.

The time is set in 24-hour military format (HH:MM:SS). The date is set in MM/DD/YY format.

Press ENTER when done.

5.2.5.2 UTILITY: CID (Circuit ID)

Edit Circuit ID:

24 CHARACTER TST MESSAGE

The Circuit ID is a user-configurable unit label. On the bottom line, use the ◀ ▶ arrow keys to first select the character to edit, and then use the ▼ ▲ arrow keys to edit that character. Press ENTER when done.

A maximum of 24 characters are available, as follows:

*[Space] () * + - , . / 0-9 and A-Z.*

Press ENTER once you compose the string – the MBT-5000A removes all trailing spaces from the string upon entry.

5.2.5.3 UTILITY: Display (VFD Display Brightness)

```
Display Brightness:
100%
```

To edit the display brightness: Use the ▼ ▲ arrow keys to select a brightness value of **25%**, **50%**, **75%**, or **100%**. Press **ENTER** when the brightness is suitable.

5.2.5.4 UTILITY: Firmware



THESE MENUS ARE INTENDED FOR DIAGNOSTIC PURPOSES ONLY. DO NOT CHANGE AN IMAGE UNLESS OTHERWISE INSTRUCTED BY COMTECH EF DATA PRODUCT SUPPORT.

This series of submenus permits you to view information about the MBT-5000A internal firmware. The MBT-5000A can store two complete firmware images. You can select which image loads the next time the unit reboots.

```
Firmware Images:
Info Select  (< ▶ E)
```

Use the ▼ ▲ arrow keys to select **Info** or **Select**, and then press **ENTER**.

5.2.5.4.1 Firmware Images: Info

```
Firmware Info: Bootrom
Image#1 Image#2
```

Use the ▼ ▲ arrow keys to select **Bootrom**, **Image#1**, or **Image#2**, and then press **ENTER** to view the information.

When you select **Image#1**, or **Image#2**, these submenus require further selection (where 'X' denotes **1** or **2**):

```
Image#X: Bulk APP FPGA
```

Use the ◀ ▶ arrow keys to select **Bulk**, **App**, or **FPGA**, and then press **ENTER**. If, for example, you select **Bulk**, a screen formatted similar to the following example displays:

```
Bulk: FW-0000303
2.1.X MM/DD/YY
```

5.2.5.4.2 Firmware Images: Select

```
Current Active Image: #1
Next Reboot Image: #1 #2
```

The top line shows the **Current Active Image**. From the bottom line, use the ◀ ▶ arrow keys to select the **Next Reboot Image** (i.e., the image that will be active the next time you reboot the unit) as **#1** or **#2**. Press **ENTER** when done..

5.2.5.5 UTILITY: LNA

LNA: ConvA ConvB

When the MBT-5000A has an LNA current supply, this screen permits you to enable or disable the LNA operation, allow calibration of the LNA reference current, and set the window (range) for alarms and faults.

Use the ◀ ▶ arrow keys to select **ConvA** or **ConvB**, and then press **ENTER**. For either selection, when no LNA is present, the unit displays the following message:

This converter does NOT
Have LNA Power Source.

5.2.5.5.1 LNA: ConvX (ConvA or ConvB)

ConvX LNA: Enable Calibr

Window: Enable Range

Use the ▼ ▲ arrow keys to select the top line or bottom line. Then:

- **On the top line** – Use the ◀ ▶ arrows keys to select **Enable** (LNA Operation) or **Calibr** (Reference current Calibration).
- **On the bottom line** – Use the ◀ ▶ arrows keys to select **Enable** (LNA alarms/faults) or **Range** (alarms/faults window).

Press **ENTER** to continue.

ConvX LNA: Enable (LNA Operation)

ConvX LNA Current Src:

Disable Enable (◀ ▶ E)

On the bottom line, use the ◀ ▶ arrow keys to select **Disable** or **Enable**, and then press **ENTER**.

ConvX LNA: Calibr (Calibrate Reference Current)

ConvX LNA Ref = 400.0 mA

Calibrate: No Yes (◀ ▶ E)

On the bottom line, use the ◀ ▶ arrow keys to select **No** or **Yes**, and then press **ENTER**. If you select **Yes** and the LNA successfully calibrates, the current value appears on the top line of the screen (e.g., **400.0 mA**).

If calibration fails, however, the error message “**Calibration failed. Out of Range.**” Displays, and the MBT-500 returns you to the previous menu. You will also observe, once the previous menu re-displays, that no value appears on the top line for the reference current (e.g., **N/A**):

ConvX LNA Ref = N/A

Calibrate: No Yes (◀ ▶ E)

ConvX LNA: (Window) Enable

ConvX LNA Window:
Disable Enable (◀ ▶ E)

On the bottom line, use the ◀ ▶ arrow keys to **Disable** or **Enable** LNA alarms/faults handling, and then press **ENTER**.

ConvX LNA: (Window) Range

ConvX LNA Range:
20%

On the bottom line, use the ▼ ▲ arrow keys to select a range percentage from **20%** to **50%**, and then press **ENTER**.

5.2.6 SELECT: Test Menu Branch

TEST: Lamptest

Press **ENTER** to begin the diagnostics run on the front panel LED arrays and VFD. The Side A and Side B LEDs will cycle, and the VFD will briefly generate a test pattern.

Once the test has run, press **CLEAR** to return to the SELECT: (Main) menu.

Chapter 6. ETHERNET-BASED REMOTE PRODUCT MANAGEMENT

6.1 Overview

Ethernet-based Remote Product Management of the MBT-5000A L-Band Up/Down Converter System is available using the rear panel '**J9 10/100 Ethernet**' port.



1. **To proceed with Ethernet-based Remote Product Management, assumptions are made that:**
 - *The MBT-5000A is operating with the latest version firmware files.*
 - *The MBT-5000A is connected to a user-supplied Windows-based PC as follows:*
 - *The PC's serial port is connected to the MBT-5000A rear panel 'J1 COM 1' serial port with a user-supplied serial cable.*
 - *The PC's Ethernet port is connected to the MBT-5000A rear panel 'J9 10/100 ETHERNET' port with a user-supplied hub, switch, or direct Ethernet cable connection.*
 - *The PC is running a terminal emulation program (for operation of the MBT-5000A serial remote control interface) and a compatible Web browser (for operation of the MBT-5000A HTTP (Web Server) Interface).*
 - *The MBT-5000A's Management IP Address has been noted using the MBT-5000A Front Panel.*
2. **Use of the Ethernet based SNMP Interface is recommended only for advanced users. All other users are strongly encouraged to use the MBT-5000A HTTP Interface for Monitor and Control (M&C) of the MBT-5000A.**

6.2 Ethernet Management Interface Protocols

The user PC facilitates access to Ethernet-based remote M&C of the MBT-5000A through three separately-operated protocols:

- **Simple Network Management Protocol (SNMP).** This requires a user-supplied Network Management System (NMS) and a user-supplied Management Information Base (MIB) File Browser.
- **Telnet Interface.** This requires use of the user PC's Command-line interface, or a user-supplied terminal emulation program such as HyperTerminal.
- **MBT-5000A HTTP (Web Server) Interface.** This requires a compatible user-supplied Web browser such as Internet Explorer.



For SNMP, Telnet, or HTTP operation, the MBT-5000A must be configured with the Ethernet control option. Via the front panel, select CONFIG: Remote Control → Ethernet. See Chapter 5. FRONT PANEL OPERATION for further information.

6.3 SNMP Interface

The SNMP is an Internet-standard protocol for managing devices on IP networks. The SNMP-managed network consists of three key components:

- **The managed device.** This includes the MBT-5000A.
- **The SNMP Agent.** This is the software that runs on the MBT-5000A. The MBT-5000A SNMP Agent supports both **SNMPv1** and **SNMPv2c**.
- **The user-supplied Network Management System (NMS).** This is the software that runs on the manager.

6.3.1 Management Information Base (MIB) Files

MIB files are used for SNMP remote management of a unique device. A MIB file consists of a tree of nodes called Object Identifiers (OIDs). Each OID provides remote management of a particular function. These MIB files should be compiled in a user-supplied MIB Browser or SNMP Network Monitoring System server. The following MIB files are associated with the MBT-5000A:

MIB File/Name (where 'x' is revision letter)	Description
FW-0021082x.mib ComtechEFData Root MIB file MBT-5000A MIB file	ComtechEFData MIB file gives the root tree for ALL Comtech EF Data products and consists of only the following OID: Name: comtechEFData Type: MODULE-IDENTITY OID: 1.3.6.1.4.1.6247 Full path: iso(1).org(3).dod(6).internet(1).private(4).enterprises(1).comtechEFData(6247) Module: ComtechEFData MIB file consists of all of the OIDs for management of the amplifier functions
FW-0021083x.mib MBT-5000A Traps MIB file	Trap MIB file is provided for SNMPv1 traps common for MBT-5000A.

6.3.2 SNMP Community Strings



In SNMP v1/v2c, the SNMP Community String is sent unencrypted in the SNMP packets. Caution must be taken by the network administrator to ensure that SNMP packets travel only over a secure and private network if security is a concern.

The MBT-5000A uses Community Strings as a password scheme that provides authentication before gaining access to the MBT-5000A agent's MIBs. They are used to authenticate users and determine access privileges to the SNMP agent.

Type the SNMP Community String into the user-supplied MIB Browser or Network Node Management software. You must define three Community Strings for SNMP access:

- Read Community default = public
- Write Community default = private
- Trap Community default = comtech



For proper SNMP operation, the MBT-5000A MIB files must be used with the associated version of the MBT-5000A Remote Router M&C. Refer to the MBT-5000A Firmware Release Notes for information on the required FW/SW compatibility.

6.3.3 SNMP Traps

The MBT-5000A supports both **SNMPv1** traps and **SNMPv2** notifications. The MBT-5000A has the ability to send out SNMP traps when certain events occur in the unit. A trap is sent both when a fault occurs and is cleared. Configure which style of traps the MBT-5000A sends by using the MBT-5000ASNMPTrapVersion OID.

The following MIB2 SNMPv1traps and SNMPv2 notifications are supported by the MBT-5000A:

MIB2 SNMPv1 trap: Authentication Failure	5
MIB2 SNMPv2 notifications: Authentication Failure	1.3.6.1.6.3.1.1.5.5

The following Faults SNMPv1 traps and SNMPv2 notifications are supported by the MBT-5000A.

Faults SNMPv1 traps:

mbt5000ABaseUnitFaultV1	6247501
mbt5000AConvAFaultV1	6247502
mbt5000AConvBFaultV1	6247503

Faults SNMPv2 notifications:

mbt5000ABaseUnitFaultEvent	1.3.6.1.4.1.6247.50.2.1.1
mbt5000AConvAFaultEvent	1.3.6.1.4.1.6247.50.2.1.2
mbt5000AConvBFaultEvent	1.3.6.1.4.1.6247.50.2.1.3

6.4 Telnet Interface

The MBT-5000A provides a Telnet interface for the purpose of Equipment M&C via the standard equipment Remote Control protocol. The Telnet interface requires user login at the **Administrator** level and **Read/Write** level. An example of the login process is shown here:

```
COMTECH EF DATA MBT TELNET INTERFACE
You must have an account to use this interface.
Please see your administrator.

Enter name: comtech
Enter password: comtech
Name and Password accepted. Please review your MBT manual for command syntax.

<Q=Quit> Telnet-->_
```

Once logged into the Telnet interface as Administrator, you can access the standard remote control interface defined in **Chapter 7. SERIAL-BASED REMOTE PRODUCT MANAGEMENT**, as shown here:

```
COMTECH EF DATA MBT TELNET INTERFACE
You must have an account to use this interface.
Please see your administrator.

Enter name: comtech
Enter password: comtech
Name and Password accepted. Please review your MBT manual for command syntax.

<Q=Quit> Telnet--><1/LRS=2
>0001/LRS=
<Q=Quit> Telnet-->
```

6.4.1 Telnet Operation via HyperTerminal

There is a disadvantage when using Windows Command-line as a Telnet client. Since Command-line cannot translate a '\r' (i.e., carriage return or "CR") to a '\r\n' (i.e., CR+line feed "LF") for the messages coming from Telnet Server, any multi-line Target-to-Controller response (e.g., the response to the FRW? query) will be displayed as one line, with the latter lines overwriting the previous lines.

To view the full response messages, CEFD recommends use of the HyperTerminal terminal emulation program, configured as a Telnet client.

Configure HyperTerminal as follows:

1. Ensure that the connection is made using **TCP/IP (Winsock)** instead of COM1 or COM2, as shown at the near right.
2. ASCII Setup (File → Properties → Settings → ASCII Setup): Check the "**Send line ends with line feeds**" option in the *ASCII Sending* section, and the "**Append line feeds to incoming line ends**" option in the *ASCII Receiving* section, as shown at the far right.

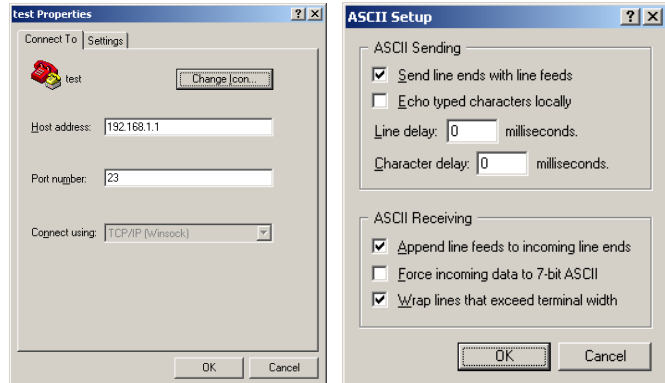

Login and remote command/query execution, when using HyperTerminal as the interface, is shown in this example:

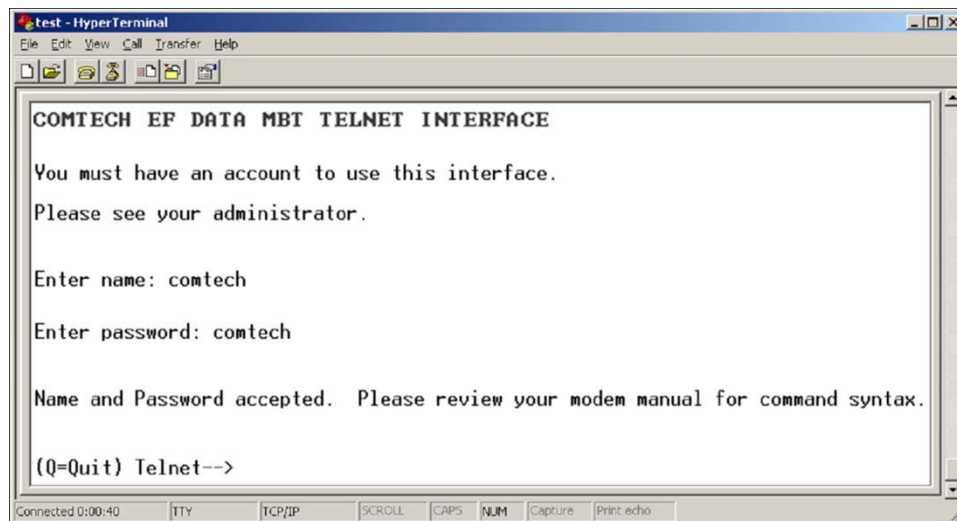

6.5 HTTP (Web Server) Interface

A user-supplied Web browser allows the full M&C of the MBT-5000A from its HTTP Interface. This non-secure, embedded Web application is designed for, and works best with, Microsoft's Internet Explorer Version 5.5 or higher (the examples shown use Internet Explorer Version 7.0).

6.5.1 Enable the Web Server Interface



Verify the IP Address from the MBT-5000A front panel menus: CONFIG: Remote Control → Ethernet → Address. See Chapter 5. FRONT AND REAR PANEL OPERATION for complete details about using this local M&C interface.

To enable the Web Server Interface in the MBT-5000A using only a 100BaseTx remote interface (this assumes you are running Microsoft Windows OS), do these steps:

1. Select **Start**, then **Run**, then type "**cmd**" to open the command prompt window:

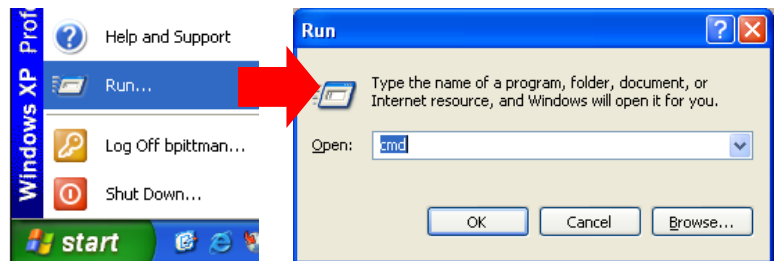

2. Start a Telnet session with the unit at the default IP address of **192.168.1.4**:

```
Microsoft Windows XP [Version 5.1.2600]
(C) Copyright 1985-2001 Microsoft Corp.
C:\>telnet 192.168.1.4_
```

3. Enter the Telnet username and password (the default for both parameters is **comtech**):

```
COMTECH EF DATA TELNET INTERFACE
You must have an account to use this interface.
Please see your administrator.
Enter name: comtech
Enter password: comtech
```

Failure to enter the correct User name and Password will return you to a blank login screen.

6.5.2 User Login

1. From the PC, type **http://192.168.1.4** (the default IP address for the MBT-5000A) into the **Address** area of the browser:

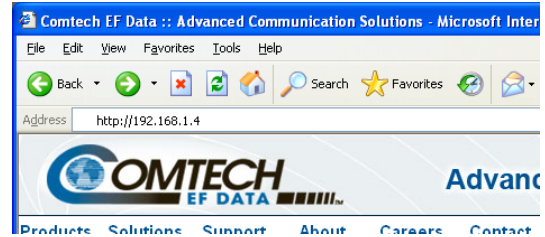

2. You are then prompted to type in a valid **User name** and **Password**, similar to the dialog box shown to the right. For all interfaces, the default for both is **comtech**.

Type the **User name** and **Password**, and then click **[OK]**.

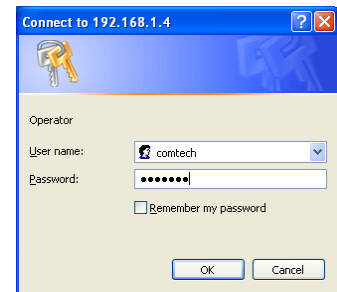

Failure to enter the correct User name and Password will return you to a blank Login window. Otherwise, once the valid IP address and login information is entered, the MBT-5000A Web Server Interface “Splash” page is displayed, similar to the example shown here:

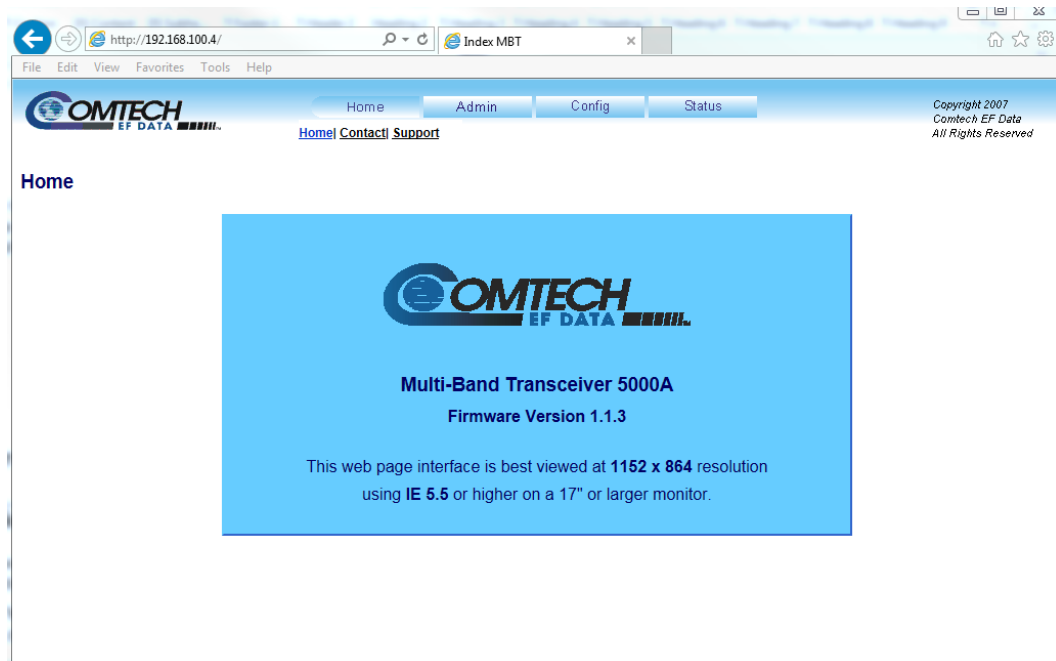

6.5.3 Web Server Interface – Operational Features

6.5.3.1 Navigation

This manual uses a naming format for all Web Server Interface pages to indicate the depth of navigation needed to view the referenced page: “**Top Level Tab | HTTP Page Hyperlink.**”

For example: “**Home | Support**” is interpreted to mean “*first* click the top-level ‘**Home**’ navigation tab; *then*, click the ‘**Support**’ page hyperlink.”

Roll the cursor over the navigation tabs located at the top of each page, and then select from the available hyperlinks.



6.5.3.2 Page Sections

Each page is divided into operational content sections. Whether there is one section to a page, or there are multiple sections, the title at the upper-left corner of each page and its sections provide a reference to its operational features.



6.5.3.3 Action Buttons

Action buttons are important in the MBT-5000A HTTP Interface. Click an action button to do one of these tasks:

- Reset changed parameters to remove **unsaved** changes.
- Permanently save changes.
- Refresh the page with current data.



If you edit a field, make sure to click the action button before you leave the page. If you go to another page without first clicking the action button, your changes are not saved.

6.5.3.4 Drop-down Lists

A drop-down list lets you choose from a list of selections. Left-click the drop-down button to open the list. Then, left-click on an item to select that choice.

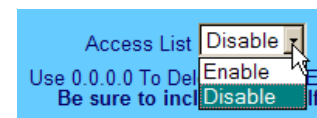

6.5.3.5 Text or Data Entry

Text boxes let you type data into a field. An action button may be associated with a single text box, or a group of text boxes. For any text box, left-click anywhere inside the box, type the desired information into that field, and be sure to press **[ENTER]** when done.

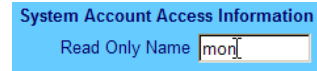

Click the related action button to save the data.



If you edit any field, make sure to click the action button before you leave the page. If you go to another page without first clicking the action button, your changes are not saved.

6.5.4 Web Server Interface – Menu Tree

Navigation of the MBT-5000A HTTP Interface is illustrated with this menu tree:

Home	Admin	Config	Status
Home	Access	MBT	Events
Contact	SNMP	Utility	Status
Support		Redundancy	

This interface provides access to four navigation tabs (shown in blue):

- **Home**
- **Admin
(Administration)**
- **Config
(Unit Configuration)**
- **Stats
(Status)**

Beyond the top-level row of navigation tabs, the diagram illustrates the available nested hyperlinks (shown in grey) that allow more specific functionality.

Click any tab or hyperlink to continue.

6.5.5 Web Server Interface – Page Descriptions

The sections and subsections that follow detail the Web pages accessible via hyperlink from the “Splash” page navigation tabs shown in **Sect. 6.5.4**:

- **Sect. 6.5.5.1 Home Pages**
- **Sect. 6.5.5.2 Admin (Administration) Pages**
- **Sect. 6.5.5.3 Config (Configure MBT-5000A) Pages**
- **Sect. 6.5.5.4 Status Pages**

6.5.5.1 Home Pages

Select **Home**, **Contact**, or **Support** tab to continue.

6.5.5.1.1 Home | Home

From any location within the MBT-5000A Web Server Interface, click the **Home** top navigation tab and/or the nested hyperlink to return back to this top-level page. Use this page to identify the product.



Figure 6-1. Home | Home Page

6.5.5.1.2 Home | Contact



For all product support, please call:

+1.240.243.1880

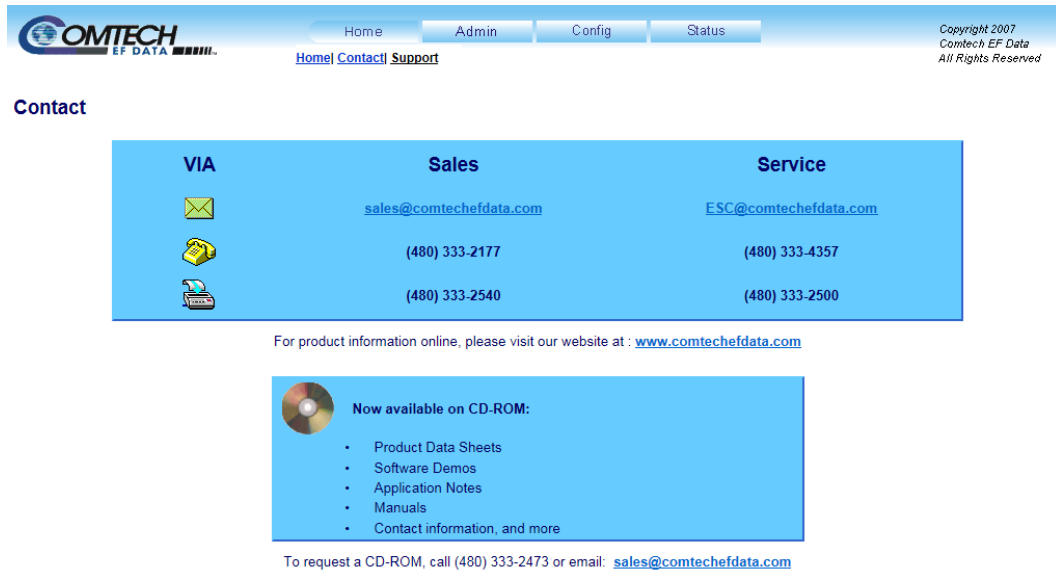
+1.866.472.3963 (toll free USA)



The screenshot shows the 'Contact' page of the COMTECH EF DATA website. At the top, there is a navigation bar with buttons for 'Home', 'Admin', 'Config', and 'Status'. Below the navigation bar, the 'Contact' section is highlighted. It features a table with three columns: 'VIA', 'Sales', and 'Service'. The 'VIA' column contains icons for email, fax, and a document. The 'Sales' column lists the email address sales@comtechefdata.com and two phone numbers: (480) 333-2177 and (480) 333-2540. The 'Service' column lists the email address ESC@comtechefdata.com and two phone numbers: (480) 333-4357 and (480) 333-2500. Below the table, there is a link to the website www.comtechefdata.com. A section titled 'Now available on CD-ROM:' lists several items: Product Data Sheets, Software Demos, Application Notes, Manuals, and Contact information, and more. At the bottom, there is a note that to request a CD-ROM, one should call (480) 333-2473 or email sales@comtechefdata.com.

VIA	Sales	Service
	sales@comtechefdata.com	ESC@comtechefdata.com
	(480) 333-2177	(480) 333-4357
	(480) 333-2540	(480) 333-2500

For product information online, please visit our website at : www.comtechefdata.com

Now available on CD-ROM:

- Product Data Sheets
- Software Demos
- Application Notes
- Manuals
- Contact information, and more

To request a CD-ROM, call (480) 333-2473 or email: sales@comtechefdata.com

Figure 6-2. Home | Contact Page

6.5.5.1.3 Home | Support

Use this page to submit any issues to CEFD Customer Support by clicking the email link.

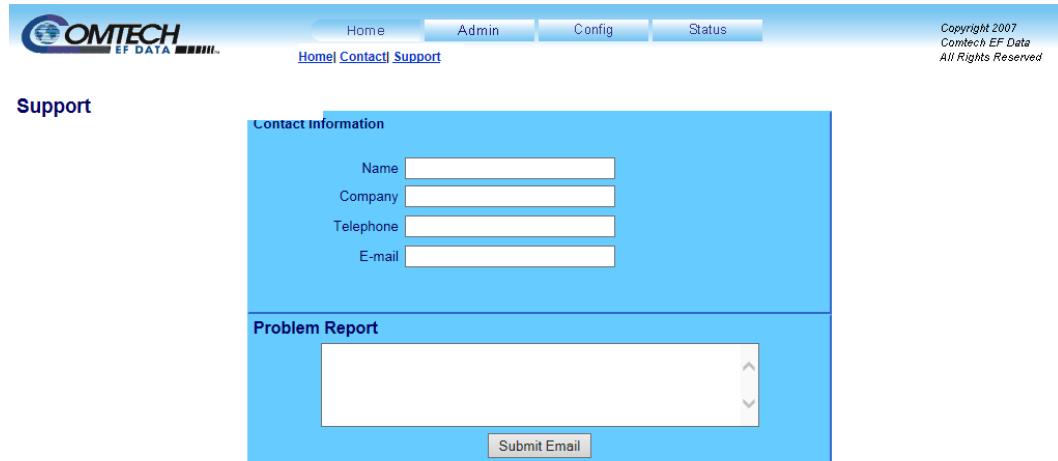

COMTECH EF DATA

Home Admin Config Status

Copyright 2007
Comtech EF Data
All Rights Reserved

[Home](#) | [Contact](#) | [Support](#)

Support

Contact information

Name

Company

Telephone

E-mail

Problem Report

Figure 6-3. Home | Support Page

6.5.5.2 Admin Pages



The Admin pages are available only to users who have logged in using the Administrator Name and Password.

The Administrator may use these pages to: Set up user names, passwords, the e-mail server, and the host IP Addresses as required for communication with the MBT-5000A Web Server Interface.

Click the **Access** or **SNMP** tab to continue.

6.5.5.2.1 Admin | Access

Use this page to set up and maintain user names, passwords, the e-mail server, and the host IP addresses to facilitate communication with the MBT-5000A Web Server Interface.

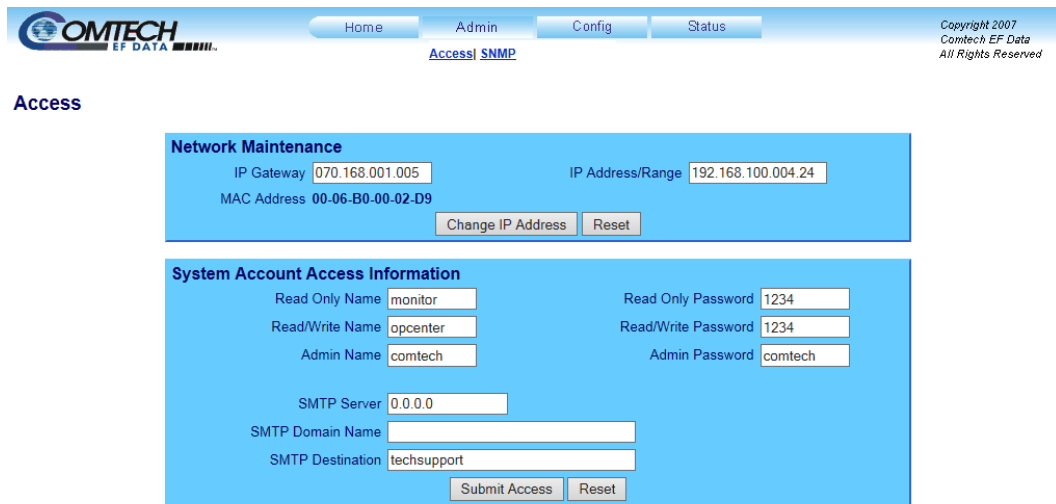

Figure 6-4. Admin | Access Page

Network Maintenance

- **IP Gateway, IP Address/Range:** Enter the desired IP Gateway Address and IP Address/Range in these text boxes.
- **MAC Address (read-only):** The MAC is set at the factory to a guaranteed unique address that you cannot modify.

Click **[Change IP Address]** to save. If it is desired to revert to the previously assigned IP Gateway and IP Address/Range, click **[Reset]** instead.

System Account Access Information

- **Admin, Read/Write, and Read Only Names and Passwords:**

The factory defaults for these names/passwords are:

- **Admin** comtech/comtech
- **Read/Write** opcenter/1234
- **Read Only** monitor/1234

Note the following:

- These **Name** fields can be any alphanumeric combination with a maximum length of 10 characters.
 - These **Password** fields can be any alphanumeric combination with a maximum length of 10 characters.
- **SMTP Server:** Specify the mail server IP address from where you want to send the e-mail.
 - **SMTP Domain Name / Destination:** The Administrator can assign the SMTP Domain Name and Destination.
 - For **SMTP Domain Name**, specify the domain of the e-mail server (usually found to the right of the @ symbol in an e-mail address).
 - For **SMTP Domain Destination**, specify the e-mail recipient name (usually found to the left of the @ symbol in an e-mail address).

Click **[Submit Access]** to save. If it is desired to revert back to the previously assigned System Account Access Information, click **[Reset]** instead.

6.5.5.2.2 Admin | SNMP

Use this page to set and returns administration information for the MBT-5000A SNMP feature.



Figure 6-5. Admin | SNMP Page

SNMP

- **Simple Network Management Operational Status:** Use the drop-down list to select the Simple Network Management operational setting as **Enabled** or **Disabled**.
- The **SNMP Read** and **Write Community String** fields can be any combination of characters and a length of 0 - 20 characters:
 - The factory default for the **Read Community String** parameter is **public**.
 - The factory default **Write Community String** is **private**.
- **Enable Authentication Trap:** Use the drop-down list to select the Enable Authentication Trap operational setting as **Enabled** or **Disabled**.
- The Administrator can assign up to two **SNMP Trap IP** addresses and one **SNMP Trap Community String**. The **SNMP Trap Community String** field can be any combination of characters and a length of 0 - 20 characters:
 - The factory default for the **Trap Community String** is **comtech**.
- **Trap Version:** Use the drop-down list to select the SNMP Trap Version as **SNMPv1** or **SNMPv2**.

For details pertaining to the remaining configuration parameters available on this page, see **Sect. 6.3 SNMP INTERFACE**.

Click [**Submit SNMP**] to save. If it is desired to revert to the previously assigned SNMP designations, click [**Reset**] instead.

6.5.5.3 Config Pages

Select the **MBT**, **Utility**, or **Redundancy** tab to continue.

6.5.5.3.1 Config | MBT

Use this page to configure the communications, operations, and alarms/faults handling for the MBT-5000A base unit and separate converters.

The screenshot shows the 'Config | MBT' page with the following sections:

- Navigation:** Home, Admin, Config (selected), Status. Copyright 2007 Comtech EF Data. All Rights Reserved.
- Configuration Summary:** A: X BUC ATT= 0.00 Flt=0 TX=ON B: Ku BUC ATT= 0.00 Flt=0 TX=ON REDUNDANCY: OFF ONLINE: A
- Serial:** Interface Type: RS-485 4-wire, Remote Address: 1, Baud Rate: 9600. Buttons: Change Serial Configuration, Reset.
- Base Unit:** Fault Recovery: Automatic, Reference Frequency Adjust (0-255): 087. Button: Change Base Unit Configuration.
- Converter A:** Attenuation (dB): 00.00, Mute: Off, Frequency (MHz): N/A, Attenuation Offset: N/A. Button: Change Converter A Configuration.
- Converter B:** Attenuation (dB): 00.00, Mute: Off, Frequency (MHz): N/A. Button: Change Converter B Configuration.
- Converter A LNA and LPT:** LNA Current Source: Disable, LNA Current Window: Disable, LNA Current Window (%): N/A, Low Forward Power Threshold: N/A. Button: Submit.
- Converter B LNA and LPT:** LNA Current Source: Disable, LNA Current Window: Disable, LNA Current Window (%): N/A, Low Forward Power Threshold: N/A. Button: Submit.
- Calibrate LNA Current:** Converter A Reference Point: N/A, Converter B Reference Point: N/A. Buttons: Calibrate Converter A, Calibrate Converter B.

Figure 6-6. Config | MBT Page

Serial

- **Interface Type:** Use the drop-down list to select the operating interface type as **RS232**, **RS485 2-wire** or **RS 485 4-wire**.
- **Remote Address:** Enter a valid physical remote address from **0001** to **9999**.
- **Baud Rate:** Use the drop-down list to select the operating baud rate as **2400**, **4800**, **9600**, **19200**, or **38400** baud.

Click **[Change Serial Configuration]** to save. If it is desired to revert back to the previously assigned settings, click **[Reset]** instead.

Base Unit

- **Fault Recovery:** Use the drop-down list to select the Fault Recovery function as **Manual** or **Automatic**.
- **Reference Frequency Adjust:** Enter a numeric value from 0 to 255 to adjust the reference oscillator tuning voltage. The default value is set to 87.

Click **[Change Base Unit Configuration]** to save.

Converter A / B

Typical for both sections:

- **Attenuation (dB):** Enter a valid attenuation level (**00.00** to **20.00** dB) in 0.25 dB steps.
- **Attenuation Offset (Converter A only):** Enter a valid value, in dB, for the attenuation offset.
- **Mute:** Use the drop-down list to select the Mute function as **On** or **Off**.
- **Frequency:** Enter an operating RF Frequency (if the converter is a Ku-Band down converter) in the range of **10950** to **12750** MHz. Otherwise, this field will display as **N/A**.

Click **[Change Convert X Configuration]** (where '**X**' designates Converter **A** or Converter **B**) to save.

Converter A / B LNA and LPT

Typical for both sections, when the MBT-5000A BDC is optionally equipped and configured:

- **LNA Current Source:** Use the drop-down list to select this feature as **Enabled** or **Disabled**.
- **LNA Current Window (%):** This field defines the size of the LNA Current Window, and determines the fault thresholds for the LNB current draw.

Any LNA current reading that is outside the window may generate an alarm, a fault, or may be masked entirely depending on the state of the user configured fault mask (see the **MSK** command syntax in **Chapter 7. SERIAL-BASED REMOTE PRODUCT MANAGEMENT** for more information).

For example: If the LNA draws 100mA, and the LNB current fault window is set to the **default** value of **30** (%), then the allowable current draw for the LNA will be from 70 mA minimum to 130 mA maximum because the window is +/- 30% centered on the calibrated LNA current draw.

- **LNA Current Window:** Use the drop-down list to select this feature as **Enabled** or **Disabled**.
- **Low Power Threshold (dBm):** Use this field to set the threshold value, in dBm, for the low forward power alarm/fault. If the forward power drops below the specified value, the alarm/fault will be indicated if the forward power monitor is set to **Alarm** or **Fault** instead of the factory default of **Mask**.

Setting this parameter to the default value of 00.00 effectively **disables** the threshold.

Click **[Submit]** to save.

Calibrate LNA Current



Calibrate the optionally installed LNA only when it is running at nominal operating conditions.

This page provides the value of the LNA Current Supply (in mA) as a reference point. The LNA current alarm upper and lower thresholds are determined by this calibrated LNA reference point and the LNA current window setting.

Click **[Calibrate Converter X]** (where 'X' designates Converter **A** or Converter **B**) to perform an LNA calibration and display the updated **read-only** value.

6.5.5.3.2 Config | Utility

Use this page to configure MBT-5000A operating parameters.

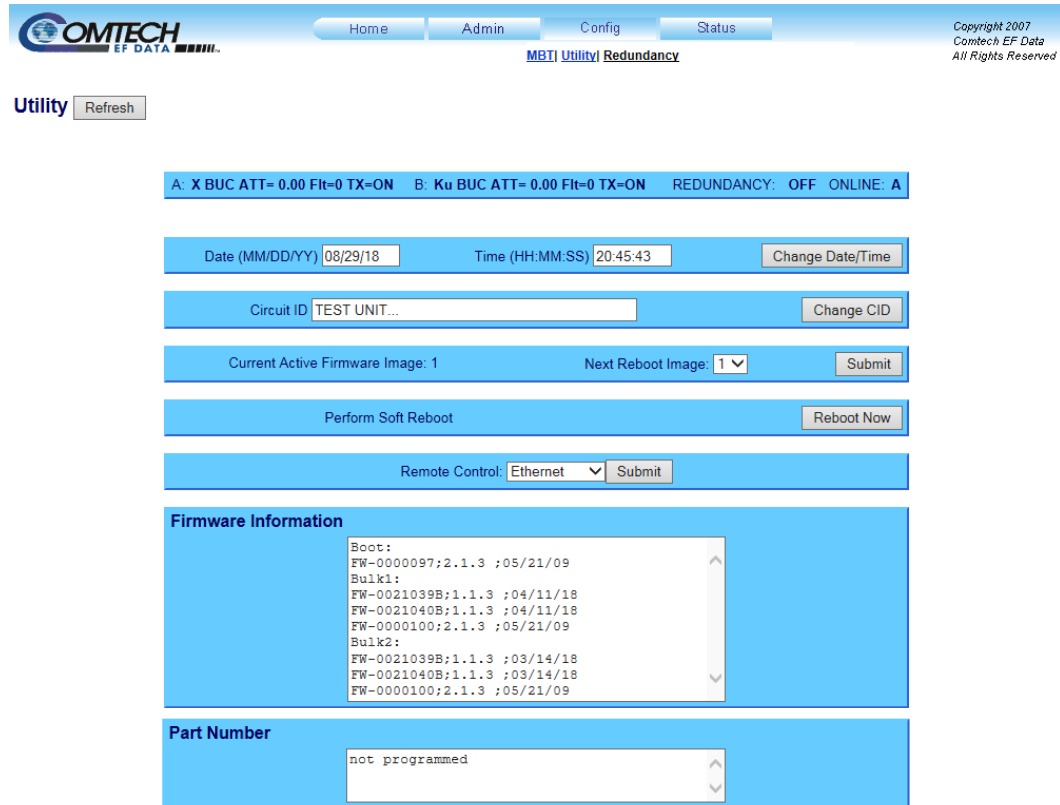

The screenshot shows the 'Utility' page of the MBT-5000A management interface. At the top, there is a navigation bar with 'Home', 'Admin', 'Config', and 'Status' tabs. Below this, there are links for 'MBT', 'Utility', and 'Redundancy'. The 'Utility' page includes a 'Refresh' button and a status bar showing 'A: X BUC ATT= 0.00 Flt=0 TX=ON B: Ku BUC ATT= 0.00 Flt=0 TX=ON REDUNDANCY: OFF ONLINE: A'. The main configuration area contains several sections: 'Date (MM/DD/YY)' set to '08/29/18' and 'Time (HH:MM:SS)' set to '20:45:43', with a 'Change Date/Time' button; 'Circuit ID' set to 'TEST UNIT...' with a 'Change CID' button; 'Current Active Firmware Image' set to '1' and 'Next Reboot Image' set to '1' with a 'Submit' button; a 'Perform Soft Reboot' section with a 'Reboot Now' button; and a 'Remote Control' section with a dropdown set to 'Ethernet' and a 'Submit' button. Below these are two sections: 'Firmware Information' showing a list of firmware versions (Boot, Bulk1, Bulk2) and 'Part Number' set to 'not programmed'.

Figure 6-7. Config | Utility Page

Date and Time

- Enter a date in the form MM/DD/YY (where MM = month [01 to 12], DD = day [01 to 31], and YY = year [00 to 99]).
- Enter a time using HH:MM:SS format (where HH = hour [00 to 23], MM = minutes [00 to 59], and SS = seconds [00 to 59]).

Click **[Change Date/Time]** to save.

Circuit ID

Enter a Circuit ID string of up to 48 characters, and then click **[Change CID]** to save.

Current Active Firmware Image *(read-only)*

This section identifies the selected **Current Active Firmware Image**. In this example, **Image 2** is the **Current Active Firmware Image**.

Next Reboot Image

Use the drop-down list to select **Reboot Image 1** or **2**. Press **[Submit]** when done.

Perform Soft Reboot

Click **[Reboot Now]** to reboot the MBT-5000A using the **Current Active Firmware Image**.

Remote Control

Use the drop-down list to select **Front Panel, Serial, Ethernet**. Press **[Submit]** when done.

Firmware Information

This scrollable window identifies the Bootrom, Bulk Image#1 and Bulk Image #2.

Base Unit Part Number

The part number for the MBT-5000A chassis (i.e., the “base unit”) is identified here.

6.5.5.3.3 Config | Redundancy



Appendix B. MBT-5000A REDUNDANCY OPERATION.

Use this page to configure the MBT-5000A's Redundancy Switch Mode.

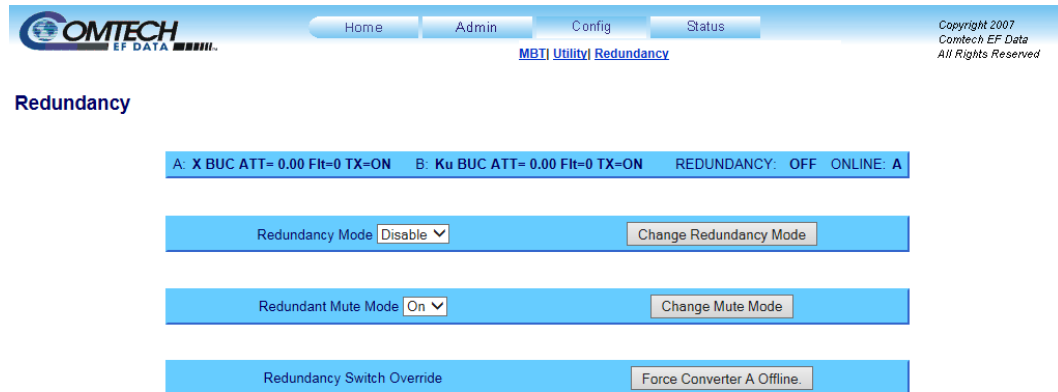

Figure 6-8. Config | Redundancy Page

Use the drop-down list to **Enable** or **Disable** Redundancy Mode. Then, click [**Change Redundancy Mode**] to update MBT-5000A operation to this selected Redundancy Mode status.

6.5.5.4 Status Pages

The hyperlinks available under the 'Status' tab provide you with access to event logging, operational statistics, and status windows. Click the **Events** or **Status** hyperlink to continue.

6.5.5.4.1 Status | Events

Use this page to review pertinent information about stored events, and to define the MBT-5000A alarm parameters that determine how those events are triggered.

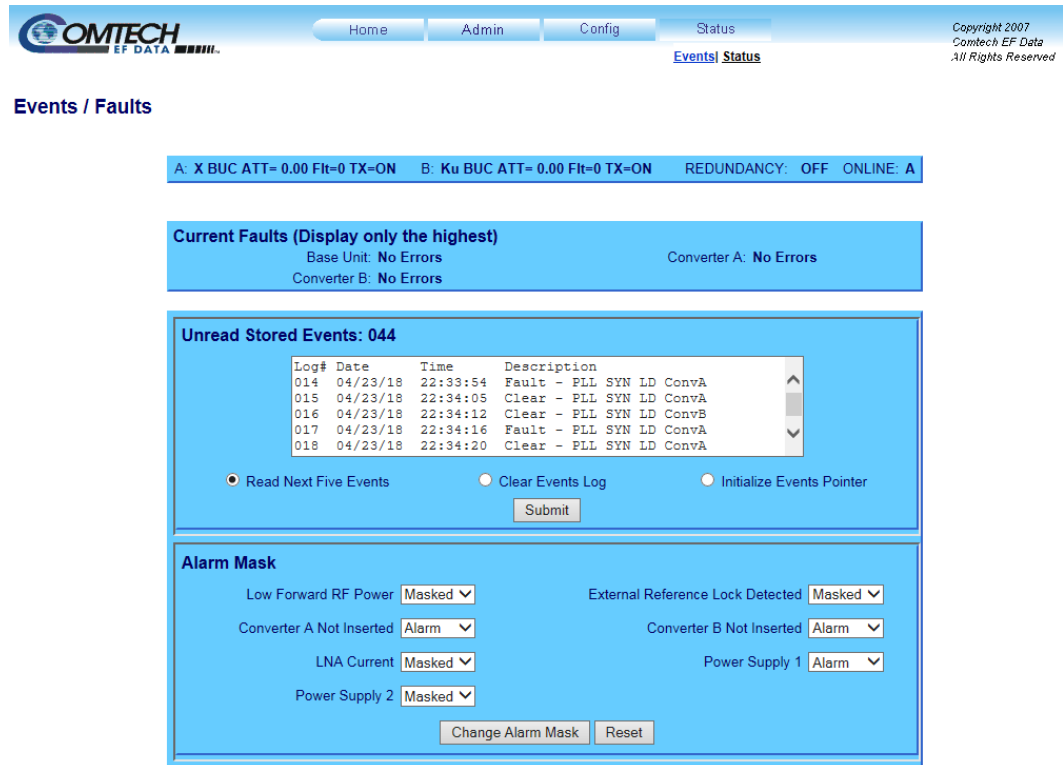

OMTECH EF DATA

Home Admin Config Status

Events | Status

Copyright 2007
Comtech EF Data
All Rights Reserved

Events / Faults

A: X BUC ATT= 0.00 Ft=0 TX=ON B: Ku BUC ATT= 0.00 Ft=0 TX=ON REDUNDANCY: OFF ONLINE: A

Current Faults (Display only the highest)
Base Unit: No Errors Converter A: No Errors
Converter B: No Errors

Unread Stored Events: 044

Log#	Date	Time	Description
014	04/23/18	22:33:54	Fault - PLL SYN LD ConvA
015	04/23/18	22:34:05	Clear - PLL SYN LD ConvA
016	04/23/18	22:34:12	Clear - PLL SYN LD ConvB
017	04/23/18	22:34:16	Fault - PLL SYN LD ConvA
018	04/23/18	22:34:20	Clear - PLL SYN LD ConvA

Read Next Five Events
 Clear Events Log
 Initialize Events Pointer

Submit

Alarm Mask

Low Forward RF Power: Masked
 External Reference Lock Detected: Masked
 Converter A Not Inserted: Alarm
 Converter B Not Inserted: Alarm
 LNA Current: Masked
 Power Supply 1: Alarm
 Power Supply 2: Masked

Change Alarm Mask Reset

Figure 6-9. Status | Events Page

Current Faults (Display only the highest)

This **read-only** section displays the running tally of stored events log for the entire MBT-5000A unit (i.e., Base Unit and Converters A and B).

Unread Stored Events

This section features a **read-only** scrollable window that displays the unread stored events log in sequential, date-stamped format. A running tally of the number of unread stored events is displayed in the window header. The unit returns and displays the five oldest stored events in the alarm log. All events that are read from the log are also automatically removed from the log.

Manage the Unread Stored Events window as follows:

- **Read Next Five Events:** Select to display the next five unread stored events in the log.
- **Clear Events Log:** Select to clear all stored events from the log.
- **Initialize Events Pointer:** Select to reset the internal pointer to allow queries to start at the beginning of the stored events log.

Click **[Submit]** to execute the choice – the window will update according to the selection made.

Alarm Mask

Use the drop-down lists to select each alarm as **Fault**, **Alarm**, or **Masked** for:

- **Low Forward RF Power** (operable when the BUC is optionally configured with the Power Monitor feature).
- **Converter A Not Inserted.**
- **Converter B Not Inserted.**
- **LNA Current Detect** (operable when the BDC is optionally configured with an LNA).
- **External Reference Lock Detected.**
- **PS** (Power Supply 1 or 2).

Click **[Change Alarm Mask]** to save. If it is desired to revert back to the previously assigned Alarm Mask settings, click **[Reset]** instead.

6.5.5.4.2 Status | Status

Use this **read-only** page to review pertinent information about the MBT-5000A operating configuration.



The screenshot shows the 'Status | Status' page with the following information:

- System Status:** A: X BUC ATT= 0.00 Flt=0 TX=ON B: Ku BUC ATT= 0.00 Flt=0 TX=ON REDUNDANCY: OFF ONLINE: A
- Model Information:**
 - Model Number: Multi-Band Transceiver 5000A
 - Software Revision: Boot:2.1.3 Bulk1:1.1.3 Bulk2:1.1.3
 - Active Software Image: Bulk 1
 - ConvA Serial Number: 161005409
 - ConvB Serial Number: 161008724
- Power Supply Readings:**
 - 19V Power Supply 1: 19.3 Volts
 - 5V Power Supply 1: 5.3 Volts
 - 12V: 12.1 Volts
 - 8V: 8.0 Volts
 - 19V Power Supply 2: 19.3 Volts
 - 5V Power Supply 2: 5.3 Volts
 - 15V: 15.4 Volts
 - Reference Osc. Tuning: 4.9 Volts
- Operational Parameters:**
 - Local Switch Position: Converter A
 - Base Equipment Odometer: 6503
 - Base Faults: No Faults
 - ConvA Summary Fault: OFF
 - ConvA Equipment Odometer: 736
 - ConvA Temperature: 32.0 degree C
 - ConvA LNA Current: N/A
 - ConvA Forward RF Power: N/A
 - ConvB Summary Fault: OFF
 - ConvB Equipment Odometer: 1826
 - ConvB Temperature: 33.8 degree C
 - ConvB LNA Current: N/A
 - ConvB Forward RF Power: N/A
- Converter A Details:**
 - Converter A Part Number: PL-0022615
 - Equipment Type: 5000 X Band BUC (RF: 07900-08400, IF: 00950-01450)
- Converter B Details:**
 - Converter B Part Number: not programmed
 - Equipment Type: 5000 Ku-Band BUC (RF: 13750-14500, IF: 00950-01700)

Figure 6-10. Status | Status Page

(General Information)

Product identification (i.e., model and serial numbers), active software image information, and active operating temperature and power/current readings are provided here. Note the following:

- Valid ConvA/ConvB LNA Current readings are provided only if the pertinent MBT-5000A BDC is optionally configured with an LNA. These parameters otherwise will display as **N/A** if the pertinent converter is a BUC.
- Valid Conv A/ConvB Forward RF Power readings are provided only if the pertinent MBT-5000A up BUC is optionally configured with the Power Monitor feature. These parameters otherwise will display as **N/A** if the pertinent converter is a BDC.
- Valid Power Supply 2 and Local Switch Position information is provided with redundant configurations only.
- Converter A or B Odomter, in hours.
- Converter A or B Summary Fault State (ON or OFF).
- Base Odomter, in hours.
- Base Fault Status (No Faults or No Errors).

Converter A or B Part Number Type

These scrollable Part Number windows identify the part numbers for the converter modules installed in the 'A' and 'B' slots.

Converter A or B Equipment Type

The scrollable Equipment Type windows identify the function of each module slot (BUC or BDC) along with the associated RF conversion band and frequencies. This area also displays the IF frequency range. **Note:** Ci-Band indicates C-Band inverted output. KuN-Band indicates Ku-Band Narrow. Ku Down has multiple sub RF ranges and an "*" indicates which one is selected.

6.6 Critical Status

The MBT-5000A provides Critical Status via `http:<path>/ CriticalStatus.xml`.

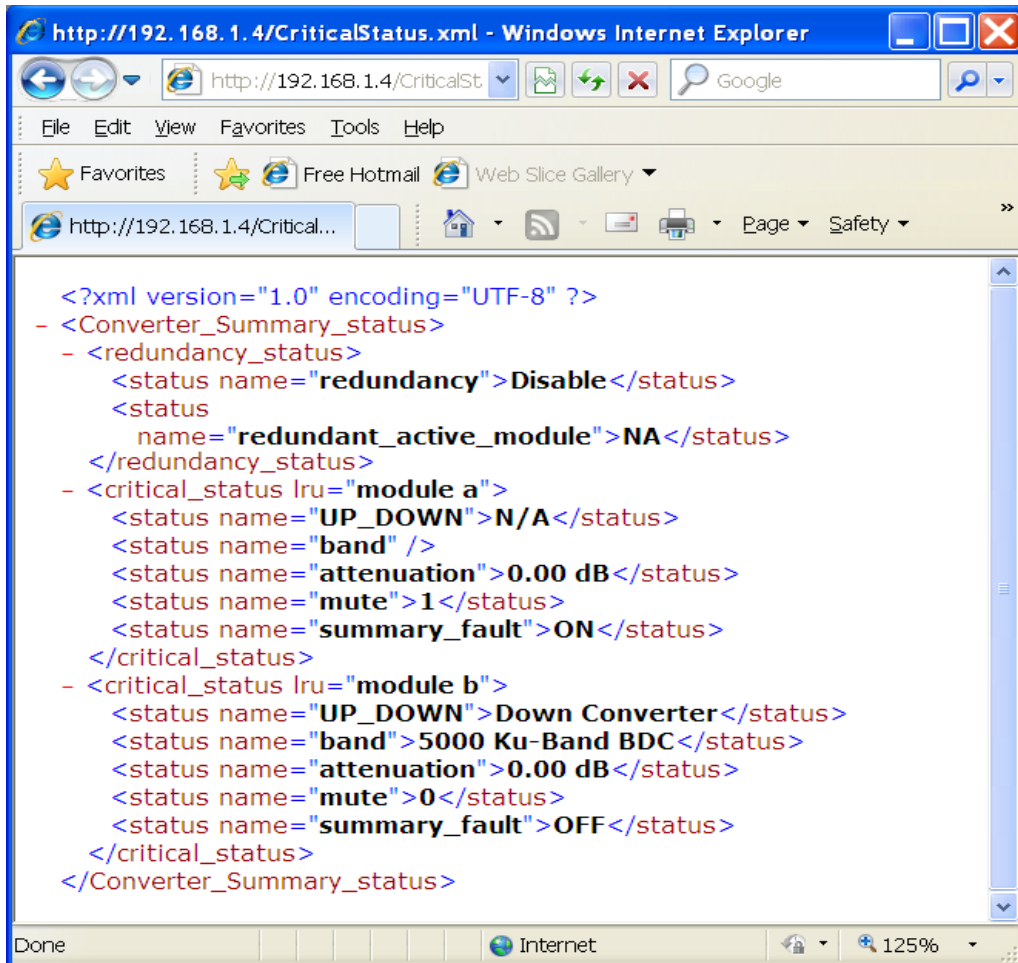

```

<?xml version="1.0" encoding="UTF-8" ?>
- <Converter_Summary_status>
- <redundancy_status>
  <status name="redundancy">Disable</status>
  <status
    name="redundant_active_module">NA</status>
</redundancy_status>
- <critical_status lru="module a">
  <status name="UP_DOWN">N/A</status>
  <status name="band" />
  <status name="attenuation">0.00 dB</status>
  <status name="mute">1</status>
  <status name="summary_fault">ON</status>
</critical_status>
- <critical_status lru="module b">
  <status name="UP_DOWN">Down Converter</status>
  <status name="band">5000 Ku-Band BDC</status>
  <status name="attenuation">0.00 dB</status>
  <status name="mute">0</status>
  <status name="summary_fault">OFF</status>
</critical_status>
</Converter_Summary_status>
    
```

Figure 6-11. Critical Status Page

Chapter 7. SERIAL-BASED REMOTE PRODUCT MANAGEMENT

7.1 Overview

Serial-based Remote Product Management of the MBT-5000A L-Band Up/Down Converter System is available using the rear panel ‘J1 COM 1’ serial port.



- 1) **To proceed with Serial-based Remote Product Management, assumptions are made that:**
 - The MBT-5000A is operating with the latest version firmware files.
 - The MBT-5000A is connected to a user-supplied Windows-based PC as follows:
 - The PC’s serial port is connected to the MBT-5000A rear panel ‘J1 COM 1’ serial port with a user-supplied serial cable.
 - The PC’s Ethernet port is connected to the MBT-5000A rear panel ‘J9 10/100 ETHERNET’ port with a user-supplied hub, switch, or direct Ethernet cable connection.
 - The PC is running a terminal emulation program (for operation of the MBT-5000A serial remote control interface) and a compatible web browser (for operation of the MBT-5000A Web Server (HTTP) Interface).
 - The MBT-5000A’s Management IP Address has been noted using the MBT-5000A Front Panel.
- 2) **USE OF THE SERIAL-BASED REMOTE PRODUCT MANAGEMENT INTERFACE IS RECOMMENDED ONLY FOR ADVANCED USERS. ALL OTHER USERS ARE STRONGLY ENCOURAGED TO USE THE MBT-5000A WEB SERVER INTERFACE FOR M&C OF THE MBT-5000A. SEE CHAPTER 6. ETHERNET-BASED REMOTE PRODUCT MANAGEMENT.**

The MBT-5000A Serial Remote Product Management is available through the rear panel serial interface. This electrical interface is either an EIA-485 multi-drop bus (for the control of many devices) or an EIA-232 connection (for the control of a single device), and data is transmitted in asynchronous serial form, using ASCII characters. Control and status information is transmitted in packets of variable length, in accordance with the structure and protocol defined in later sections.



See Chapter Sect. 3.2.3.5 'J1 | COM 1' EIA-485/232 Interface Connector (DB-9F) for the 'J1 | COM 1' remote control connector pinouts.

7.1.1 EIA-485

For applications where multiple devices are to be monitored and controlled, a full-duplex (4-wire plus ground) EIA-485 is preferred. Half-duplex (2-wire plus ground) EIA-485 is possible, but is not preferred. In full-duplex EIA-485 communication, there are two separate, isolated, independent, differential-mode twisted pairs, each handling serial data in different directions.

It is assumed that a 'Controller' device (a PC or dumb terminal) transmits data in a broadcast mode via one of the pairs. Many 'Target' devices are connected to this pair, and all simultaneously receive data from the Controller. The Controller is the only device with a line-driver connected to this pair; the Target devices have only line-receivers connected.

In the other direction: On the other pair, each Target has a tri-state line driver connected; the Controller has a line-receiver connected. All the line drivers are held in high-impedance mode until one – and only one – Target transmits back to the Controller. Each Target has a unique address; each time the Controller transmits, the address of the intended recipient Target is included in a framed 'packet' of data. All of the Targets receive the packet, but only one (the intended) will reply. The Target enables its output line driver and transmits its return data packet back to the Controller in the other direction on the physically separate pair.

EIA-485 (full duplex) summary:

- Two differential pairs - one pair for Controller-to-Target, one pair for Target-to-Controller.
- Controller-to-Target pair has one line driver (Controller), and all Targets have line-receivers.
- Target-to-Controller pair has one line receiver (Controller), and all Targets have tri-state drivers.

7.1.2 EIA-232

This is a much simpler configuration in which the Controller device is connected directly to the Target via a two-wire-plus-ground connection. Controller-to-Target data is carried, via EIA-232 electrical levels, on one conductor, and Target-to-Controller data is carried in the other direction on the other conductor.

7.2 Remote Commands and Queries Overview

7.2.1 Basic Protocol

Whether in EIA-232 or EIA-485 mode, all data is transmitted as asynchronous serial characters, suitable for transmission and reception by a UART. The asynchronous character format is 8-N-1 (8 data bits, no parity, one stop bit).

The supported baud rates are 2400, 4800, 9600, 19200, and 38400 baud.

All data is transmitted in framed packets as asynchronous serial characters, suitable for transmission and reception to the Controller using a universal asynchronous receiver/transmitter (UART). Controller-to-Target data is carried via EIA-232 electrical levels on one conductor, and Target-to-Controller data is carried in the other direction on the other conductor:

- **Controller-to-Target:** The Controller device (e.g., the user PC/CLI) is used to transmit instructions (commands) to – or to request information from (queries) – the Target device (i.e., the MBT-5000A).
- **Target-to-Controller:** The Target, in return, only transmits response information to the Controller when specifically directed by the Controller.

For Serial Remote Control, all issued commands (**Controller-to-Target**) require a response (**Target-to-Controller**). This response is either to return data that has been queried by the Controller, or to confirm the Target's receipt of a command to change the Target's configuration.

7.2.2 Packet Structure

The exchange of information is transmitted, Controller-to-Target and Target-to-Controller, in packets. Each packet contains a finite number of bytes consisting of printable ASCII characters, excluding ASCII code 127 (DELETE).

In this context, the Carriage Return and Line Feed characters are considered printable. All messages from Controller-to-Target require a response, with one exception: This will be either to return data that has been requested by the Controller, or to acknowledge reception of an instruction to change the configuration of the Target. The exception to this is when the Controller broadcasts a message (such as Set Time/Date) using Address 0, when the Target is set to EIA-485 mode.

Controller-to-Target (Issued Command or Query)						
Start of Packet	Target Address	Address Delimiter	Instruction Code	Code Qualifier	Optional Arguments	End of Packet
< ASCII code 60 (1 character)	0000 (default) (4 characters)	/ ASCII code 47 (1 character)	(3 characters)	= or ? ASCII codes 61 or 63 (1 character)	(n characters)	Carriage Return ASCII code 13 (1 character)

Packet Example: <0000/RSH=30[cr]

Target-to-Controller (Response to Command or Query)						
Start of Packet	Target Address	Address Delimiter	Instruction Code	Code Qualifier	Optional Arguments	End of Packet
> ASCII code 62 (1 character)	0000 (default) (4 characters)	/ ASCII code 47 (1 character)	(3 characters)	= or ? ASCII codes 61 or 63 (1 character)	(n characters)	Carriage Return ASCII code 13 (1 character)

Packet Example: >0000/BBU=107[cr][lf]

Detailed description of the packet components follow.

7.2.2.1 Start of Packet

- **Controller-to-Target:** This is the character '<' (ASCII code 60).
- **Target-to-Controller:** This is the character '>' (ASCII code 62).

The '<' and '>' characters indicate the start of packet. They may not appear anywhere else within the body of the message.

7.2.2.2 Target Address

Up to 9,999 devices can be uniquely addressed; in **EIA-485** applications, the permissible range of values is 1 to 9999. The address is programmed into a Target unit using the remote control port.

Each block converter module has its own address:

Module	Address
MBT-5000A	Base
Block Converter A	Base + 1
Block Converter B	Base + 2

If several devices share an EIA-485 bus, it must be noted that the MBT-5000A will require three addresses, and should be spaced apart accordingly.



The Controller sends a packet with the address of a Target – the destination of the packet. When the Target responds, the address used is the same address, to indicate to the Controller the source of the packet. The Controller does not have its own address.

7.2.2.3 Address Delimiter

This is the “forward slash” character '/' (ASCII code 47).

7.2.2.4 Instruction Code

This is a three-character alphabetic sequence that identifies the message subject.

Wherever possible, the instruction codes have been chosen to have some significance – e.g., **FRE** for Operating **FRE**quency, **IPA** for Management **IP** Address, etc. This aids in the readability of the message, should it be displayed in its raw ASCII form.

Upper case and lower case alphabetic characters may be used ('A' to 'Z' and 'a' to 'z', ASCII codes 65-90 and 97-172).

7.2.2.5 Instruction Code Qualifier

This is a single character that further qualifies the preceding instruction code. Code Qualifiers obey the following rules:

From Controller-to-Target, the only permitted characters are:

Character	Definition
= (ASCII code 61)	<p>This character is used as the Assignment Operator (AO). It establishes that the Instruction Code that precedes it is to be used as a command to assign or configure operation. The instruction set that follows serves to assign the Target's new parameter setting or operational value.</p> <p>Example: From Controller-to-Target, MUT=1 means "enable the mute function."</p>
? (ASCII code 63)	<p>This character is used as the Query Operator (QO). It establishes that the Instruction Code that precedes it is to be used as a query that returns the Target's current configured parameter setting or operational value.</p> <p>Example: From Controller-to-Target, MUT? means "what's the current state of the MUTE function?"</p>

From Target-to-Controller, the only permitted characters are:

Character	Definition
= (ASCII code 61)	This character is used in two ways: <ol style="list-style-type: none"> If the Controller sends a query to the Target – for example: MUT? meaning “what’s the current state of the MUTE function?”, the Target would respond with MUT=x, where x represents the state in question: 1 being enabled, and 0 being disabled. If the Controller sends an instruction to set a parameter to a particular value, and the value sent is valid, the Target acknowledges the message and responds with MUT= (with no message arguments).
? (ASCII code 63)	If the Controller sends an instruction to set a parameter to a particular value, and the value sent is not valid, the Target then acknowledges the message and responds with, for example, MUT? (with no message arguments). This indicates that there was an error in the message sent by the Controller.
! (ASCII code 33)	If the Controller sends an instruction code that the Target does not recognize, the Target responds by echoing the invalid instruction, followed by ! Example: XYZ!
* (ASCII code 42)	If the Controller sends the command to set a parameter to a particular value, and the value sent is valid BUT the router will not permit that particular parameter to be changed at present, the Target acknowledges the message and responds with, for example, MUT* (with message arguments).
# (ASCII code 35)	If the Controller sends an instruction code which the Target cannot currently perform because of hardware resource issues, then the Target will acknowledge the message by echoing the invalid instruction, followed by the # character. This response can only occur if the operator sends two or more ‘hardware configuration’ type commands without allowing adequate time between commands for the hardware to be configured. For example, if the operator issued commands to change both the frequency and the attenuation with less than 100 milliseconds between commands, and if this response is returned, then the command has not been accepted and the operator must resend the command.
\$ (ASCII code 36)	The Target acknowledges the message indicating that this block converter is not installed.

7.2.2.6 Optional Message Arguments

Arguments are not required for all messages. Arguments are ASCII codes for the characters ‘0’ to ‘9’ (ASCII codes 48 to 57), period ‘.’ (ASCII code 46), and comma ‘,’ (ASCII code 44).

7.2.2.7 End of Packet

Controller-to-Target: This is the 'Carriage Return' ([CR]) character (ASCII code 13).

Target-to-Controller: This is the two-character sequence 'Carriage Return', 'Line Feed' ([cr][lf]) (ASCII codes 13 and 10). Both indicate the valid termination of a packet.

7.3 Remote Commands and Queries

The table that follows provides a 'quick reference' to the Instruction Codes available at present for M&C of the MBT-5000A. The 'C' and 'Q' columns, where marked with an 'X', denote whether that Instruction Code is Command Only, Query Only, or Command and Query.

Section 7.3.1

Instr Code	C	Q	Page
AFR	X	X	7-11
CAE	X	-	7-11
CID	X	X	7-11
DAY	X	X	7-11
EOD	X	X	7-11
ESA	X	X	7-12
ESL	X	X	7-12
ESW	X	X	7-12
FLT	-	X	7-13
FRW	-	X	7-12
IEP	X	-	7-13
IMG	X	X	7-13
IPA	X	X	7-14

Instr Code	C	Q	Page
IPG	X	X	7-14
ISP	X	-	7-14
LRS	X	X	7-14
MAC	-	X	7-14
MPS	X	X	7-15
MSK	X	X	7-15
NUE	-	X	7-15
NUS	-	X	7-15
PNM	-	X	7-16
RBT	X	-	7-16
RCS	-	X	7-16
REF	X	X	7-16
RM2	-	X	7-17

Instr Code	C	Q	Page
RMS	-	X	7-17
RNE	-	X	7-19
RNS	-	X	7-18
SBR	X	X	7-20
SNO	-	X	7-20
SPA	X	X	7-20
SSI	X	X	7-20
SWR	-	X	7-20
TIM	X	X	7-21
TPE	X	X	7-21
TPS	X	X	7-21

Section 7.3.2

Instr Code	C	Q	Page
AOF	X	X	7-22
ATT	X	X	7-22
CLC	X	X	7-22
CRM	X	X	7-22
CWE	X	X	7-23
EOD	-	X	7-23

Instr Code	C	Q	Page
FRE	X	X	7-23
GCC	X	X	7-23
LCS	X	X	7-23
LCW	X	X	7-24
LPT	X	X	7-24
MUT	X	X	7-24

Instr Code	C	Q	Page
PNM	-	X	7-24
RED	X	X	7-24
RET	-	X	7-25
RMS	-	X	7-25
SNO	-	X	7-25
TMP	-	X	7-25

NOTE – Instruction Code Qualifiers, as defined in **Sect. 7.2.5.5**, are used as follows in the command/query tables' **'Response to Command'** columns:

- = Message OK
- * Message OK, but not permitted in current mode
- ? Received OK, but invalid arguments found
- # Message OK, but unit is not in **Remote** mode
- ! Invalid instruction

7.3.1 MBT-5000A Base Unit Remote Commands and Queries

Parameter Type	Command (Instruction Code and Qualifier)	Arguments for Command or Response to Query	Description of Arguments (Note that all arguments are ASCII numeric codes between 48 and 57)	Response to Command (Target to Controller)	Query (Instruction Code and Qualifier)	Response to query (Target to Controller)
Auto Fault Recovery	AFR=	1 byte	Command or Query. BUC/BDC output is automatically muted in event of detected fault. If auto fault recovery is enabled, it causes output to return to pre-fault mute condition if all faults are cleared. If disabled, the output remains muted even if all faults are cleared. Clearing of fault condition will not cause a switchover in a redundant system unless the currently online unit is faulted; in which case, the newly unfaulted unit is brought online. Default Value: 1 Example: <1/AFR=1'cr' >0001/AFR='cr'lf'	AFR = AFR? AFR*	AFR?	AFR=x (Same format as Command arguments)
Clear All Stored Events	CAE=	None	Command only. Instructs unit to clear all Stored Events. This command takes no arguments. Example: <1/CAE='cr' >0001/CAE='cr'lf'	CAE=	N/A	N/A
Circuit Identification	CID=	24 bytes,	Command or Query. Sets or queries the user-defined Circuit ID string, which is a fixed length of 24 characters. Default value: ----- Valid characters include: Space () * + - . / 0 9 and A thru Z	CID= CID?	CID?	CID=x...x (See Description of Arguments)
Set RTC (Real-Time-Clock) Date	DAY=	6 bytes	Command or Query. A command in the form ddmmyy, where: dd = day of the month (between 01 and 31); mm = month of the year (between 01 and 12); and yy = year (between 00 and 99; i.e., 2000 to 2099) Example: <1/DAY=240403'cr' >0001/DAY='cr'lf' (date = April 24, 2003):	DAY= DAY? DAY*	DAY?	DAY=xxxxxx (Same format as Command arguments)
EOD (Equipment Odometer)	N/A	6 bytes	Command or Query. The total number of hours the Base unit has be running. Example: <1/EOD?'cr' >0001/EOD=000047'cr'lf'	EOD= EOD? EOD*	EOD?	EOD=xxxxxx (Same format as Command arguments)

Parameter Type	Command (Instruction Code and Qualifier)	Arguments for Command or Response to Query	Description of Arguments (Note that all arguments are ASCII numeric codes between 48 and 57)	Response to Command (Target to Controller)	Query (Instruction Code and Qualifier)	Response to query (Target to Controller)
Enable Statistics Averaging	ESA=	1 byte	Command or Query. Enables or Disables averaging of statistics data at a rate of once per second for 10 second. If disabled, burst values will be logged instead of averaged values. 0 = Disabled 1 = Enabled Default Value: 0 Example: <1/ESA=0'cr' >0001/ESA='cr''lf'	ESA= ESA?	ESA?	ESA=x (Same format as Command arguments)
Enable Statistics Logging	ESL=	1 byte	Command or Query. Enables or Disables the statistics logging function. 0 = Disable 1 = Enable Default Value: 0 Example: <1/ESL=1'cr' >0001/ESL='cr''lf'	ESL= ESL?	ESL?	ESL=x (Same format as Command arguments)
Enable Redundancy Switch Mode	ESW=	1 byte	Command or Query. Turns ON or OFF the redundancy state, where: 0 = Off 1 = On Default value: 1 Example: <1/ESW=1'cr' >0001/ESW='cr''lf'	ESW= ESW? ESW *	ESW?	ESW=x
Retrieve Firmware Number	N/A	variable length	Query only. Returns the firmware type loaded into the unit. i = Bulk Image Number (1 or 2) a = Firmware Image b = Firmware Revision c = Firmware Date	N/A	FRW?i	FRW={CR}Bot: {CR}abc{CR} }Bulk: {CR}abc {CR}abc (See Description of Arguments)

Parameter Type	Command (Instruction Code and Qualifier)	Arguments for Command or Response to Query	Description of Arguments (Note that all arguments are ASCII numeric codes between 48 and 57)	Response to Command (Target to Controller)	Query (Instruction Code and Qualifier)	Response to query (Target to Controller)
Faults and Status	N/A	4 bytes	Query Only. Unit returns the current fault and status codes for the Base Unit, Converter A and B, in the form abcd, where: a = Base Unit Faults: 0 = No faults 1 = +19V Power Supply 1 2 = +19V Power Supply 2 3 = +5V Power Supply 1 4 = +5V Power Supply 2 5 = +7.8V Power Supply 6 = Flash Checksum 7 = FPGA Done 8 = External Ref Lock Detect 9 = Converter A Not Inserted A = Converter B Not Inserted B = Switch Fault C = 12V D = 15V b, c = Converter A and B Faults: 0 = No faults 1 = Synthesizer Lock Detect 2 = Heat-sink Temperature 3 = LNA Current Supply (BDC only) 4 = Low Forward RF Power (BUC only) d = New Faults: 0 = No change in fault status since last check 1 = Change in fault status, since last check	N/A	FLT?	FLT=abcd d=Change in fault status since last poll. Note: Each section has faults listed in order of priority. For each section, only the highest priority fault is returned. There are maybe multiple faults for each section, but only the highest fault is returned.
Initialize Events Pointer	IEP=	None	Command only. Resets internal pointer to allow RNE? Queries to start at the beginning of the stored events log. Example: IEP=	IEP=	N/A	N/A
Software Image	IMG=	1 byte	Command or Query. Current Active software image, where: 1=Bulk Image # 1 currently active 2=Bulk Image # 2 currently active Example: IMG=1 (which is Image #1 active)	IMG=	IMG?	IMG=x (See Description of Arguments)

Parameter Type	Command (Instruction Code and Qualifier)	Arguments for Command or Response to Query	Description of Arguments (Note that all arguments are ASCII numeric codes between 48 and 57)	Response to Command (Target to Controller)	Query (Instruction Code and Qualifier)	Response to query (Target to Controller)
IP Address	IPA=	18 bytes	Command or Query. Sets the IP address and network prefix for the 10/100 BaseT Ethernet management port, in the form xxx.xxx.xxx.xxx.yy, where: xxx.xxx.xxx.xxx is the IP address, and yy is the network prefix (8-30) Default Value: 192.168.001.004.24 Example: IPA=192.168.001.004.24	IPA= IPA? IPA* IPA#	IPA?	IPA= xx.xxx.xxx.xxx. yy (See Description of Arguments)
Gateway Address	IPG=	15 bytes	Command or Query. Sets the Gateway IP address for the 10/100 Base Tx Ethernet management port, in the form: xxx.xxx.xxx.xxx, where: xxx.xxx.xxx.xxx is the IP address Default Value: 192.168.001.005 Example: IPG = 192.168.001.005	IPG= IPG? IPG*	IPG?	IPG = xxx.xxx.xxx.xx x
Initialize Statistics Pointer	ISP=	None	Command only. Resets internal pointer to allow RNS? Queries to start at the beginning of the stored statistics log. Example: ISP=	ISP= ISP? ISP*	N/A	N/A
Local/ Remote State	LRS=	1 byte	Command or Query. Set Local or Remote 0 = Local, 1=Serial, 2=Etherne Default value: 0 Example: LRS=1 Note: The customer will always have query access in either mode. Also, the LRS command is available in all modes as a means of acquiring control. The intent of this command is to limit changes from being made on multiple interfaces at the same time.	LRS= LRS?	LRS?	LRS=x (Same format as Command arguments)
Unit MAC Address	N/A	17 bytes	Query only. MAC address of the unit, reported in hexadecimal. Example: MAC=00-06-B0-00-D2-A7	N/A	MAC?	MAC=xx-xx-xx-xx-xx-xx (See Description of Arguments)

Parameter Type	Command (Instruction Code and Qualifier)	Arguments for Command or Response to Query	Description of Arguments (Note that all arguments are ASCII numeric codes between 48 and 57)	Response to Command (Target to Controller)	Query (Instruction Code and Qualifier)	Response to query (Target to Controller)
Power Supply Alarm Mask	MPS=	2 bytes	<p>Command or Query</p> <p>Sets or returns Power Supply Alarm mask conditions in the form ab, where:</p> <p>0 = Fault, 1 = Alarm, 2 = Masked</p> <p>a = Power Supply 1</p> <p>b = Power Supply 2</p> <p>Default value: 12</p> <p>If MPS=00 and any of the voltages on either supply are out of range, then both front panel "SUM FAULT" LEDs are lit, the summary fault relay is put in the "faulted" position, it is a logged event, and no switchover occurs.</p> <p>If MPS=11 and any of the voltages on either supply are out of range, then both front panel "SUM FAULT" LEDs are lit, the summary fault relay is not affected, it is a logged event, and no switchover occurs.</p> <p>If MPS=22 and any of the voltages on either supply are out of range, then both front panel "SUM FAULT" LEDs are NOT lit (because of the power supply), the summary fault relay is NOT affected, it is NOT a logged event, and no switchover occurs.</p> <p>If BOTH power supplies are faulted, then a fault is reported even if they are masked.</p>	MPS= MPS? MPS*	MPS?	MPS=ab (see description for details of arguments)
Unit Alarm Mask	MSK=	5 bytes	<p>Command or Query.</p> <p>Alarm mask conditions. If an alarm is masked, neither an alarm or a fault is set, and the user will not know of a problem, in the form abcde, where:</p> <p>0 = Fault, 1 = Alarm, 2 = Masked</p> <p>a = Low Forward RF Power</p> <p>b = External Reference Lock detect</p> <p>c = Converter A Not Inserted</p> <p>d = Converter B Not Inserted</p> <p>e = LNA Current Detect</p> <p>Default value: 22111</p> <p>Note: There could be a variable delay in the time it takes for the internal reference to lock to an external reference, due to warm-up characteristics and frequency differences between the references. Therefore, the default setting is "masked" for the reference lock detect. This setting may be changed if the customer so desires. The delay should be less than 1 second after 30 minutes of warm-up time.</p>	MSK= MSK? MSK*	MSK?	MSK=abcde (See Description of Arguments)
Number of Unread stored Events	N/A	3 bytes	<p>Query only.</p> <p>Unit returns the Number of stored Events that remain Unread in the form xxx.</p> <p>Example: NUE=126</p>	N/A	NUE?	NUE=xxx
Number of Unread stored Statistics	N/A	3 bytes	<p>Query only.</p> <p>Unit returns the Number of stored Statistics that remain Unread, in the form xxx.</p> <p>Example: NUS=126</p>	N/A	NUS?	NUS=xxx

Parameter Type	Command (Instruction Code and Qualifier)	Arguments for Command or Response to Query	Description of Arguments (Note that all arguments are ASCII numeric codes between 48 and 57)	Response to Command (Target to Controller)	Query (Instruction Code and Qualifier)	Response to query (Target to Controller)	
Part Number	N/A	Various 1-96 bytes	Query only. Returns the Comtech EF Data part number of the unit. This part number is the unit's DOTCODE at the time it was manufactured. The DOTCODE may be up to 96 printable ASCII characters long. Example: <1/PNM?'cr' >0001/PNM=MBT5003.350WRSW00'cr'lf'	N/A	PNM?	PNM=x...x (See Description of Arguments)	
Reboot	RBT=	1 byte	Command only. Soft Reboot 1 = Reboot System	RBT = RBT? RBT*	N/A	RBT=x (See Description of Arguments)	
Retrieve Configuration Status	N/A	variable length	Query only. Used to Query the Configuration status of the unit	N/A	RCS?	RCS=x...x (See Description of Arguments)	
			Example:				Description:
			<1/RCS?'cr' >0001/RCS='cr' ESW=1'cr' AFR=1'cr' XRF=N/A'cr'lf'				Redundancy Mode Auto Fault Recovery External Reference Status
Note: For XRF (External reference status): N/A = no external reference; 05M = 5 MHz; 10M = 10 MHz. XRF will always be N/A if the internal reference oscillator option is not installed.							
Reference Oscillator Tuning	REF=	3 bytes	Command or Query. Adjusts the reference oscillator tuning voltage by sending a DAC value in the form xxx, where: xxx is a numeric value from 0 to 255. Default value: 087 Example: <1/REF=087'cr' >0001/REF='cr'lf' Note: This command sets the DAC value, but the actual Reference Oscillator tuning voltage can be monitored using the RMS command.	REF= REF? REF*	REF?	REF=xxx (Same format as Command arguments)	

Parameter Type	Command (Instruction Code and Qualifier)	Arguments for Command or Response to Query	Description of Arguments (Note that all arguments are ASCII numeric codes between 48 and 57)	Response to Command (Target to Controller)	Query (Instruction Code and Qualifier)	Response to query (Target to Controller)	
Retrieve Maintenance Status	N/A	variable length	Query only. Used to Query the Maintenance status of the unit.	N/A	RMS?	RMS=x...x (See Description of Arguments)	
			Example:				Description:
			<1/RMS?'cr' >0001/RMS='cr' P12V1=12.1'cr' P12V2=12.3'cr' P05V1=04.9'cr' P05V2=05.1'cr' P7V8T=07.8'cr' REFVT=01.2'lf' SWITC=A'cr'lf'				+12V power supply +12V power supply +5V power supply 1 +5V power supply 2 +7.8V power supply Ref. Osc. Tuning RF switch
Retrieve Maintenance Status 2	N/A	variable length	Query only. Used to Query the Maintenance status of the unit part 2:	N/A	RM2?	RM2=x...x (See Description of Arguments)	
			Example:				Description:
			<1/RM2?'cr' >0001/RM2='cr' P19V1=19.1'cr' P19V2=19.3'cr' P15V1=15.4'cr'				+19V power supply 1 +19V power supply 2 +15V power supply

Parameter Type	Command (Instruction Code and Qualifier)	Arguments for Command or Response to Query	Description of Arguments (Note that all arguments are ASCII numeric codes between 48 and 57)		Response to Command (Target to Controller)	Query (Instruction Code and Qualifier)	Response to query (Target to Controller)
Retrieve Next 5 unread stored Statistics	N/A	variable length	Query only. Unit returns the oldest 5 Stored Statistics entries which have not yet been read over the remote control. Reply format: {CR}Sub-body{CR}Sub-body{CR}Sub-body{CR}Sub-body{CR}Sub-body, where: Subbody=ddmmyyhhmmssaaa.abbb.bccc.cdd d.dee.eeff.ffghijkk.lll ddmmyy = day/month/year hhmmss = hour:minute:second aaa.a = Converter A Operating Temperature bbb.b = Converter B Operating Temperature ccc.c = Converter A RF Power output ddd.d = Converter B RF Power output ee.ee = Converter A Attenuation Setting ff.ff = Converter B Attenuation Setting g = Converter A Mute On/Off h = Converter B Mute On/Off i = Converter A Online/Offline Status j = Converter B Online/Offline Status kk.k = Converter A Tuning Voltage ll.l = Converter B Tuning Voltage If there are less than 5 entries to be retrieved, the remaining positions are padded with zeros. If there are no new entries, the response is RNS*.	N/A	RNS?	RNS={CR}Sub-body{CR}Sub-body{CR}Sub-body{CR}Sub-body{CR}Sub-body (See Description of Arguments)	

Parameter Type	Command (Instruction Code and Qualifier)	Arguments for Command or Response to Query	Description of Arguments (Note that all arguments are ASCII numeric codes between 48 and 57)	Response to Command (Target to Controller)	Query (Instruction Code and Qualifier)	Response to query (Target to Controller)
Retrieve Next 5 unread stored Events	N/A	75 bytes	Query only. Unit returns the oldest 5 Stored Events which have not yet been read over the remote control. Reply format: (CR)Sub-body(CR)Sub-body(CR)Sub-body(CR)Sub-body(CR)Sub-body, where Sub-body= ABCddmmyyhhmss: A being the fault/clear indicator. F = Fault C = Clear I = Info B being the fault type where: 1 = Base Unit 2 = Converter A 3 = Converter B C is Fault Code numbers, where For the base unit, 0 = No faults 1 = +19V Power Supply 1 2 = +19V Power Supply 2 3 = +5V Power Supply 1 4 = +5V Power Supply 2 5 = +7.8V Power Supply 6 = Flash Checksum 7 = FPGA Done 8 = External Ref Lock Detect 9 = Converter A1 Not Inserted A = Converter B2 Not Inserted B = Switch Fault C = 12V D = 15V H = Power On I = Power Off J = Log Clear K = Redundancy Config Change For the Converter A and B, 1 = Synthesizer Lock Detect 2 = Heat-sink Temperature 3 = Low Forward RF Power 4 = LNA Current Supply 5 = High Temperature (Alarm) If there are less than 5 events to be retrieved, the remaining positions are padded with zeros. If there are no new events, the response is RNE*.	N/A	RNE?	RNE=(CR)ABCddmmyyhhmss(CR)ABCddmmyyhhmss(CR)ABCddmmyyhhmss(CR)ABCddmmyyhhmss(CR)ABCddmmyyhhmss(CR)ABCddmmyyhhmss (See Description of Arguments)

Parameter Type	Command (Instruction Code and Qualifier)	Arguments for Command or Response to Query	Description of Arguments (Note that all arguments are ASCII numeric codes between 48 and 57)	Response to Command (Target to Controller)	Query (Instruction Code and Qualifier)	Response to query (Target to Controller)
Remote Baud Rate	SBR=	4 bytes	Command or Query. Set remote baud rate as follows: 2400 = 2400 baud 4800 = 4800 baud 9600 = 9600 baud 19K2 = 19200 baud 38K4 = 38400 baud Default Value: 9600 Example: <1/SBR=9600'cr' >0001/SBR=9600'cr'lf' Note: When changing baud rates remotely the response to the command will be returned using the same baud rate as that used to send the command.	SBR= SBR?	SBR?	SBR=xxxx (Same format as Command arguments)
Serial Number	N/A	9 bytes	Query only. Queries the unit 9-digit serial number. Unit returns its S/N in the form xxxxxxxx. Example: SNO=176500143	N/A	SNO?	SNO=xxxxxx xx (See Description of Arguments)
Remote Address	SPA=	4 bytes	Command or Query. Sets Physical Address - between 0001 to 9997. Resolution = 0001. Example: <1/SPA=0412'cr' >0001/SPA='cr'lf' Default Value: 0001 Note: 9998 and 9999 are reserved for the block converter A and B if the base address is 9997.	SPA= SPA?	SPA?	SPA=xxxx (Same format as Command arguments)
Set Statistics Interval	SSI=	2 bytes	Command or Query. Sets interval at which statistics are logged. Minimum resolution is 10 minutes, maximum is 90 minutes in 10 minute intervals. Default Value: 90 Example: <1/SSI=90'cr' >0001/SSI='cr'lf'	SSI= SSI?	SSI?	SSI=xx (Same format as Command arguments)
Software Revision	N/A	variable length	Query only. Unit returns the value of the internal software revision installed in the unit, in the form : Boot:x.y.z Bulk1:x.y.z Bulk2:x.y.z -or- Boot:x.y.zz Bulk1:x.y.zz Bulk2:x.y.zz	N/A	SWR?	SWR=Boot:x.y .zz Bulk1:x.y.zz Bulk2:x.y.zz (See Description of Arguments)

Parameter Type	Command (Instruction Code and Qualifier)	Arguments for Command or Response to Query	Description of Arguments (Note that all arguments are ASCII numeric codes between 48 and 57)	Response to Command (Target to Controller)	Query (Instruction Code and Qualifier)	Response to query (Target to Controller)
Set RTC Time	TIM=	6 bytes	Command or Query. Indicates the time from midnight, in the form hhmmss, where: hh = hours, between 00 and 23; mm=minutes between 00 and 59, and ss= seconds between 00 and 59. Example: <1/TIM=231259'cr' >0001/TIM='cr''lf' (time = 23 hours, 12 minutes and 59 seconds since midnight)	TIM = TIM? TIM *	TIM?	TIM=xxxxxx (Same format as Command arguments)
Time Protocol Enable	TPE=	1 byte	Command or Query. Used to enable or disable the Time Protocol, where: 0 = Time protocol disabled 1 = Time protocol enabled Example: TPE=1 (Time protocol enabled)	TPE = TPE?	TPE?	TPE=x (See Description of Arguments)
Time Protocol Server	TPS=	15 bytes	Command or Query. Used to set the Time Server IP address for the Unit Tx Ethernet management port, in the format: xxx.xxx.xxx.xxx, where: xxx.xxx.xxx.xxx is the Time server IP address Example: TPS=192.168.001.005	TPS= TPS?	TPS?	TPS=xx.xxx.xx x.xxx.yy (See Description of Arguments)

7.3.2 Block Converter (BUC / BDC) Remote Commands and Queries

Parameter Type	Command (Instruction Code and Qualifier)	Arguments for Command or Response to Query	Description of arguments (Note that all arguments are ASCII numeric codes between 48 and 57)	Response to Command (Target to Controller)	Query (Instruction Code and Qualifier)	Response to query (Target to Controller)
Attenuation Offset	AOF=	5 bytes	Command or Query. Note: Command is only for the offline converter in a redundancy mode. The valid range is -3.00 to +3.00 dB. Additionally, if the online converter attenuation is set to one extreme or the other, that value becomes the new limiting factor. For example, if the attenuation is set to 19dB, the only allowable offset will be -3 dB to +1 dB. Default Value: 00.00 Example: <2/AOF=+2.25'cr' >0002/AOF='cr'lf'	AOF= AOF? AOF*	AOF?	AOF=+x.xx or AOF=-x.xx (Same format as Command arguments)
Attenuation	ATT=	5 bytes,	Command or Query. Valid attenuation level (00.00 to 50.00 for X-Band BUC units, 00.00 to 20.00 for all other), in dB, in 0.25 dB steps as factory default. Default Value: 00.00 Example: <2/ATT=12.25'cr' >0002/ATT='cr'lf' Note: Attenuation cannot be changed for the offline unit when in redundancy mode.	ATT= ATT? ATT*	ATT?	ATT=xx.xx (Same format as Command arguments)
Calibrate LNA Current (BDC only)	CLC=	none	Command or Query. Stores the value of the LNA Current Supply (in mA) as a reference point. The LNA current alarm/fault point is then based on this point ∇ the LCW setting. Note: This command will return a mode error if the LCS output has not been enabled first. It will return 000.0 if the converter has never been calibrated. Example: <1/CLC='cr' >0001/CLC='cr'lf' The CLC query will return the value that was stored during the LNA current calibration. Example: <1/CLC?'cr' >0001/CLC=xxx.x (where xxx.x is calibrated LNA current value in mA)	CLC= CLC? CLC*	CLC?	CLC=xxx.x (see Description of Arguments)
Redundant Mute Mode	CRM=	1 byte	Command or Query. Determines how the offline unit handles the mute state during a redundant switchover condition. If the redundant mute mode is off, the offline unit will be muted. If the redundant mute mode is on, the offline unit's mute state will not be changed. 0 = Off 1 = On Default Value: 0 Example: <1/CRM=0'cr' >0001/CRM='cr'lf'	CRM= CRM?	CRM?	CRM=x (same format as Command arguments)

Parameter Type	Command (Instruction Code and Qualifier)	Arguments for Command or Response to Query	Description of arguments (Note that all arguments are ASCII numeric codes between 48 and 57)	Response to Command (Target to Controller)	Query (Instruction Code and Qualifier)	Response to query (Target to Controller)
LNA Current Window Enable (BDC only)	CWE=	1 bytes	Command or Query. Allows the user to enable the current window alarm/fault. If disabled, the LCW value will be retained, but unused. Default Value: 0 Example: <1/CWE=0'cr' >0001/CWE='cr'lf'	CWE = CWE? CWE *	CWE?	CWE =x (same format as Command arguments)
EOD (Equipment Odomter)	N/A	6 bytes	Query. The total number of hours the RF Module unit has be running. Example: <1/EOD?'cr' >0001/EOD=000047'cr'lf'	EOD= EOD? EOD*	EOD?	EOD=xxxxxx
Operating RF Frequency	FRE=xxxxx.xxx	9 bytes	Command or Query. Sets, in MHz, valid Operating RF frequency. For Ku BDC Tri-Band: FRE values: 10950-11700 MHz a LO of 10000 MHz is activated FRE values: 11700-12200 MHz a LO of 10750 MHz is activated FRE values: 12250-12750 MHz a LO of 11300 MHz is activated For Ku BDC Dual Band: FRE values: 10950-11700 MHz a LO of 10000 MHz is activated FRE values: 11700-12750 MHz a LO of 10750 MHz is activated Example: FRE=11300.000'cr' Note: Operating Frequency cannot be changed for the offline unit when in redundancy mode.	FRE= FRE? FRE*	FRE?	FRE=x....x (See Description of Arguments)
Global Converter Configuration	GCC=	variable length	Command or Query. Used to set up and query the global status of the BUC/BDC. Example: GCC=aa.aa;b:cccc.cc; 'cr' where: aa.aa = attenuation in dB (ATT) b = mute state, 0 = un-muted, 1 = muted (MUT) cccc.cc = frequency in MHz (FRE, Ku BDC only, other units will display xxxxx.xxx) Note: This command can only be queried for the offline unit when in redundancy mode.	GCC= GCC? GCC*	GCC?	GCC=x....x (See Description of Arguments)
LNA Current Source (BDC only)	LCS=	1 byte	Command or Query. Enables or Disables the LNA current source. Note: LCS must be enabled before the LNA current can be calibrated with the CLC command. LCS is always off in the redundancy mode. 0 = Disable 1 = Enable Default Value: 0 Example: <1/LCS=1'cr' >0001/LCS='cr'lf'	LCS= LCS? LCS*	LCS?	LCS=x (same format as Command arguments)

Parameter Type	Command (Instruction Code and Qualifier)	Arguments for Command or Response to Query	Description of arguments (Note that all arguments are ASCII numeric codes between 48 and 57)	Response to Command (Target to Controller)	Query (Instruction Code and Qualifier)	Response to query (Target to Controller)
LNA Current Window (BDC only)	LCW=	2 bytes	Command or Query. Allows the user to set the alarm window in $\forall\%$ of the calibrated LNA Current. Valid inputs are 20 to 50 in increments of 1%. Default Value: 30 Example: To set the alarm window to $\forall 30\%$: <1/LCW=30'cr' >0001/LCW='cr''lf'	LCW= LCW? LCW*	LCW?	LCW=xx (same format as Command arguments)
Low Forward Power Threshold (Only for the converter which supports power monitor)	LPT=	5 bytes	Command or Query. Allows the user to set the threshold for the low forward power alarm/fault in dBm. If the forward power drops below the specified value (while the unit is online, unmuted and PLL locked), the alarm/fault will be indicated. Setting this parameter to -20.0 effectively disables the threshold. Valid values for this parameter are between the unit's specified P1dB power level, and P1dB minus 19dB. For example, for a unit with +12dBm at P1dB, the range would be +12.0 to -7.0 dBm. Default Value: -20.0 Example: <2/LPT=+10.0'cr' >0002/LPT='cr''lf' Note: This command can only be queried for the offline unit in the redundancy mode.	LPT = LPT? LPT *	LPT?	LPT=xxx.x (same format as Command arguments)
Mute State	MUT=	1 byte	Command or Query. Mutes the unit, where: 0 = Disabled (Not Muted) 1 = Enabled (Muted) Default Value: 0 Example: <2/MUT=1'cr' >0002/MUT=1'cr''lf' Note: Mute State cannot be changed for the offline unit when in redundancy mode.	MUT= MUT? MUT*	MUT?	MUT=x (same format as Command arguments)
Part Number	N/A	Various 1-96 bytes	Query only. Returns the Comtech EF Data part number of the unit. This part number is the unit's DOTCODE at the time it was manufactured. The DOTCODE may be up to 96 printable ASCII characters long. Example: <2/PNM?'cr' >0002/PNM=BUCC0.350WRSW00'cr''lf'	N/A	PNM?	PNM=x...x (See Description of Arguments)
Redundancy Online Status	RED=	1 byte	Command or Query. Forces the unit to throw the switches, causing the unit to go offline (if it is currently online). The unit cannot be forced online, and sending a 1 will have no effect. 0 = Offline 1 = Online (query only) Default value: 0 Example: <2/RED=0'cr' >0002/RED='cr''lf'	RED= RED? RED*	RED?	RED=x

Parameter Type	Command (Instruction Code and Qualifier)	Arguments for Command or Response to Query	Description of arguments (Note that all arguments are ASCII numeric codes between 48 and 57)	Response to Command (Target to Controller)	Query (Instruction Code and Qualifier)	Response to query (Target to Controller)				
Retrieve Equipment Type	N/A	53 bytes (includes 'cr')	Query only. Used to Query the block converter type and its start and stop frequencies. Example: <2/RET?'cr' >0002/RET=5000A C-Band BUC'cr' 05850-06425'cr' xxxxx-xxxxx'cr' xxxxx-xxxxx'cr''lf' Example for a tri-band converter: <2/RET?'cr' >0002/RET=5000A Ku-Band BDC'cr' 10950-11700'cr' 11700-12250'cr' 12250-12750'cr''lf'	N/A	RET?	RET=x...x (See Description of Arguments)				
Retrieve Maintenance Status	N/A	Variable length	Query only. Queries the Maintenance status of the unit.	N/A	RMS?	RMS=x...x (See Description of Arguments)				
			<table border="1"> <thead> <tr> <th>Example</th> <th>Description</th> </tr> </thead> <tbody> <tr> <td> <2/RMS?'cr' >0002/RMS='cr' SYNVT=001.2'cr' HSTMP=+12.3'cr' LNACS=380.2'cr' FWPWR=004.9'cr''lf' </td> <td> Synthesizer Voltage Temperature LNA Current Supply (in mA) Forward Power </td> </tr> </tbody> </table>				Example	Description	<2/RMS?'cr' >0002/RMS='cr' SYNVT=001.2'cr' HSTMP=+12.3'cr' LNACS=380.2'cr' FWPWR=004.9'cr''lf'	Synthesizer Voltage Temperature LNA Current Supply (in mA) Forward Power
			Example				Description			
<2/RMS?'cr' >0002/RMS='cr' SYNVT=001.2'cr' HSTMP=+12.3'cr' LNACS=380.2'cr' FWPWR=004.9'cr''lf'	Synthesizer Voltage Temperature LNA Current Supply (in mA) Forward Power									
Notes: 1) If the converter does not support power monitor, will display FWPWR=xxx.x. 2) If the converter does not have LNS current supply, will display LNACS=xxx.x										
Serial Number	N/A	9 bytes	Query only. Queries the unit 9-digit serial number. Unit returns its S/N in the form xxxxxxxx. Example: SNO=176500143	N/A	SNO?	SNO=xxxxxxx xx (See Description of Arguments)				
Temperature	N/A	4 bytes	Query Only. Returns the temperatures of the heat sink in the form a sign byte followed by 3 bytes for the temperature. Example: TMP=+26.0	N/A	TMP?	TMP=sxxx (See Description of Arguments)				

Appendix A. BUC-5000x/BDC-5000x MODULE REMOVAL/INSTALLATION

A.1 Overview

This appendix illustrates the procedure required to remove and install a BUC-5000x Upconverter or BDC-5000x Downconverter module (**Figure A-1**) into any MBT-5000A L-Band Up/Down Converter System chassis.

This procedure is typical for removing or installing a module into the applicable **SIDE A** or **SIDE B** module bay in the MBT-5000A chassis.



Figure A-1. BUC-5000x/BDC-5000x Module

A.2 Module Removal Procedure

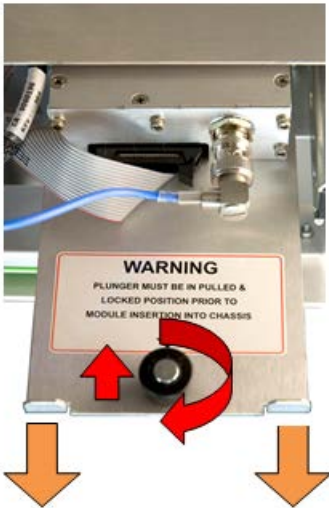
Step	Task	
1	<p>Access the modules:</p> <p>Loosen the three front panel thumb screws.</p> <p>Then, drop the front panel to access both module bays.</p>	
2	<p>Remove the module:</p> <p>First, lift the module plunger pin by turning it clockwise to lock it into removal position.</p> <p>Then, use the thumb tabs to slide the module outward to gain access to the front connectors.</p>	

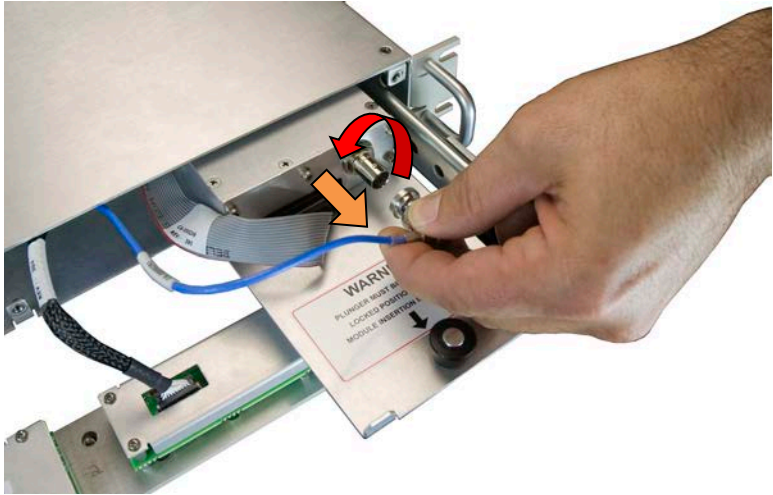
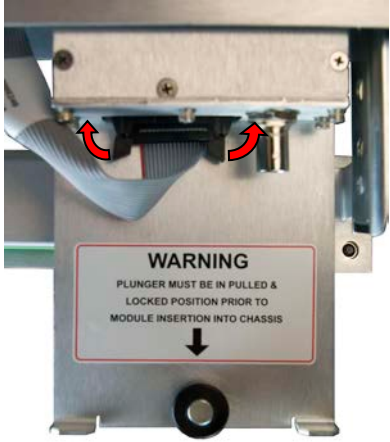
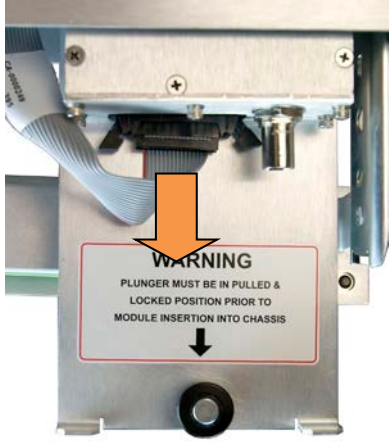

Step	Task		
3	<p>Remove the Reference Cable:</p> <p>First, unlock the connector by turning it counterclockwise.</p> <p>Then, remove the connector from its socket.</p>		
4	<p>Remove the Ribbon (Data) Cable:</p> <p>First, unlock the connector by pushing back both tabs.</p> <p>Then, remove the connector from its socket.</p>	 <p data-bbox="1045 1284 1289 1312">(a) <i>Unlock Connector</i></p>	 <p data-bbox="1547 1284 1808 1312">(b) <i>Remove Connector</i></p>

Step	Task
5	<p><i>Remove the module from the chassis:</i> Use the front tabs to slide the unit straight out until it is free and clear of its internal housing.</p> 

A.3 Module Installation Procedure

Step	Task
1	<p>Re-install the module:</p> <p>First, take care to ensure the Teflon guide ramp is properly engaged with the module.</p> <p>Then, use the front thumb tabs on the module to slide the module into a position that allows re-installation of the Reference and Ribbon Cables.</p> 

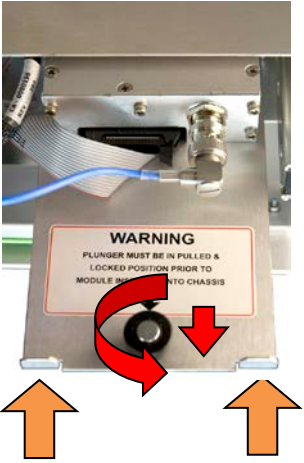
Step	Task	
2	<p>Reconnect the Ribbon (Data) Cable: First, insert the connector into its socket. Then, push both tabs into their locked position.</p>	<div style="display: flex; justify-content: space-around;"> <div data-bbox="1003 321 1388 760"> <p style="text-align: center;">(a) Install connector</p> </div> <div data-bbox="1478 321 1862 760"> <p style="text-align: center;">(b) Lock connector</p> </div> </div>
3	<p>Reconnect the Reference Cable: First, install the connector onto the socket. Then, turn the connector clockwise to lock into position.</p>	

Step	Task	
4	<p>Use the front thumb tabs on the module to slide the module the remainder of the way into the internal housing.</p> <p>Once the module is fully engaged within the internal housing, turn the plunger knob counterclockwise to drop the pin into the locked position.</p>	
5	<p>Swing the front panel back into operating position and finger-tighten the three thumbscrews.</p>	

The module installation has been completed and the MBT-5000A L-Band Up/Down Converter System is ready to be connected to other equipment. See **Chapter 3. REAR PANEL CONNECTIONS** for further information.

Appendix B. MBT-5000A REDUNDANCY OPERATION

B.1 Overview

The Comtech EF Data MBT-5000A L-Band Up/Down Converter System can be configured for redundant system operation. This appendix provides detailed information for cabling and otherwise physically configuring the MBT-5000A for redundant system operation.

B.2 Configuration

Figure B-1 shows the functional schematics for MBT-5000A redundant operation, whether configured for Single or Dual LNA redundancy.

Figure B-2 shows the cabling requirements for redundant operation.

Note that:

- BNC connections, where applicable, use 50 Ω BNC male-to-male cables.
- It is recommended that all Type 'N' to Type 'SMA' connections are best accomplished by using a Type 'N' male to Type 'SMA' female adapter, and then using Type 'SMA' female-to-female cables.
- The RF-Switch connector is 2.92 mm SMA. It is recommended to use torque wrench to tighten the connection.

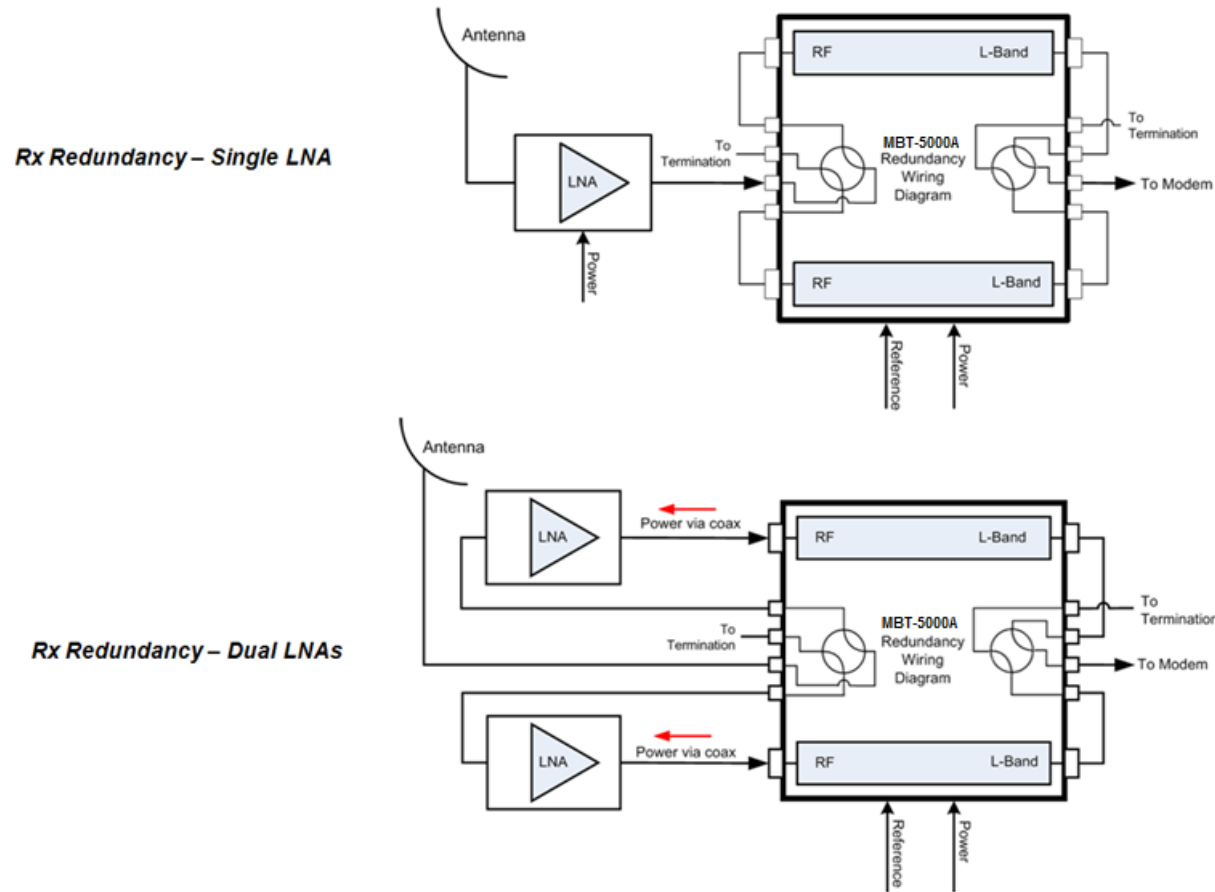

Figure B-1. MBT-5000A Redundancy – Functional Schematics

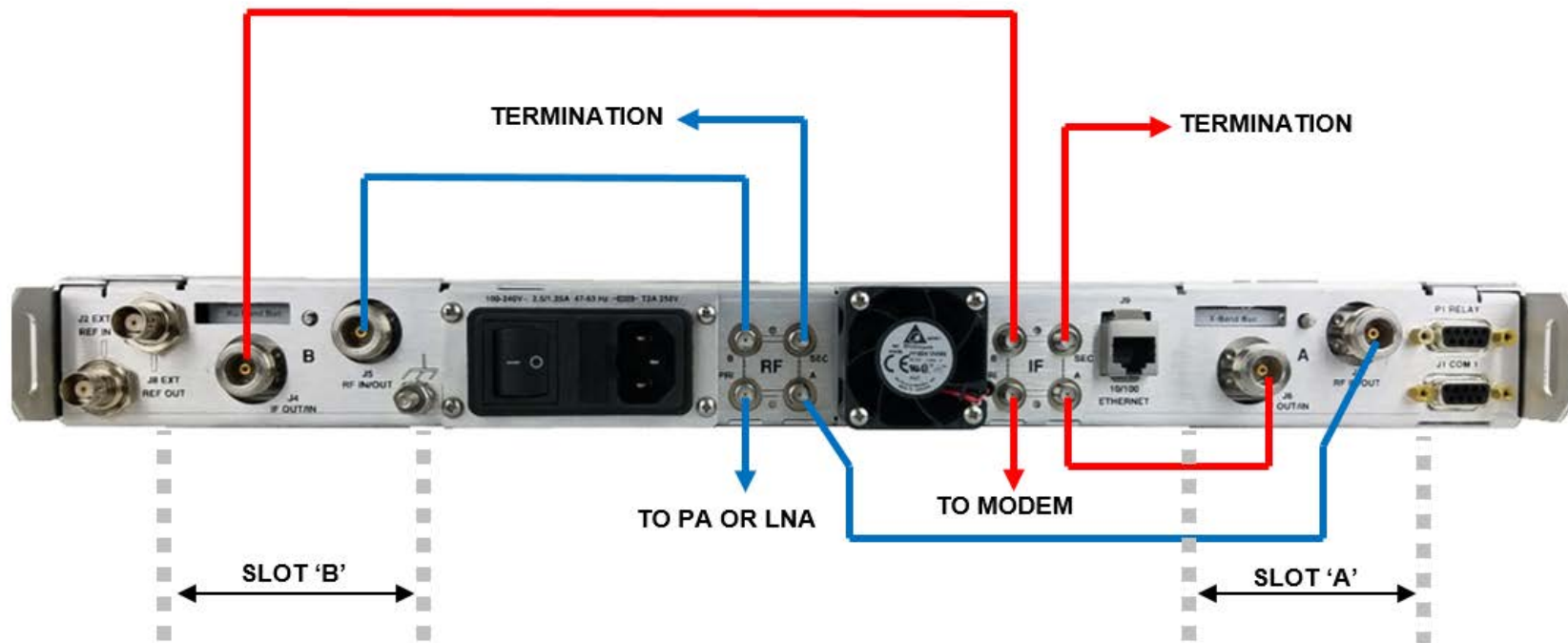

Figure B-2. MBT-5000A Redundancy Cabling Requirements



2114 WEST 7TH STREET TEMPE ARIZONA 85281 USA
480 • 333 • 2200 PHONE
480 • 333 • 2161 FAX