



CRS-150

1:1 Redundancy Switch Installation and Operation Manual

Accessory Product for use only with
Comtech EF Data CDM-600 Modems
(Requires Modem Firmware Version 1.1.0 or Higher)

IMPORTANT NOTE: The information contained in this document supersedes all previously published information regarding this product. Product specifications are subject to change without prior notice.

Copyright © 2011 Comtech EF Data. All rights reserved. Printed in the USA.
Comtech EF Data, 2114 West 7th Street, Tempe, Arizona 85281 USA, 480.333.2200, FAX: 480.333.2161

TABLE OF CONTENTS

TABLE OF CONTENTS	III
TABLES	VI
FIGURES	VI
PREFACE	VII
About this Manual	vii
Reporting Comments or Suggestions Concerning this Manual	vii
Related Documents	vii
Conventions and References	viii
Warnings, Cautions, and Notes	viii
Metric Conversion	viii
Recommended Standard Designations	viii
Trademarks	viii
Electromagnetic Compatibility (EMC) Compliance	ix
EN 55022-1997 Compliance	ix
EN 50082-1:1998 Compliance	ix
Safety Compliance	ix
EN 60950.....	ix
Electrical Safety.....	ix
Equipment Connection	x
European Low Voltage Directive (LVD)	x
Federal Communications Commission (FCC).....	x
Telecommunications Terminal Equipment Directive.....	xi
Environmental	xi
Warranty Policy	xi
Limitations of Warranty	xi
Exclusive Remedies.....	xii
Customer Support	xiii
Online Customer Support	xiii
CHAPTER 1. INTRODUCTION	1-1
1.1 Overview	1-1
1.2 Description of Features	1-2

1.3	Functional Description	1-4
1.4	Summary of Specifications.....	1-5
1.5	Dimensional Envelope	1-7
CHAPTER 2. INSTALLATION		2-1
2.1	Unpacking and Inspecting the Shipment.....	2-1
2.2	Rack-Mounting the CRS-150.....	2-2
CHAPTER 3. CONNECTOR PINOUTS		3-1
3.1	Connector Overview	3-1
3.2	Front Panel Connectors.....	3-3
3.2.1	Front Panel IF Connectors – Receive IF and Transmit IF, 50Ω BNC.....	3-3
3.2.2	Front Panel Terrestrial Data Connectors	3-4
3.2.2.1	Overhead Data Connector, DB-25M	3-4
3.2.2.2	Data Interface Connector, DB-25F	3-5
3.2.2.3	Audio Connector, DB-9F.....	3-6
3.2.2.4	G.703 Connectors	3-6
3.2.2.4.1	Balanced G.703 Interface Connector, DB-15F.....	3-6
3.2.2.4.2	Rx and Tx (Unbalanced) G.703 Connectors, 75Ω BNC	3-7
3.2.2.4.3	IDI, DDO Connectors, 75Ω BNC.....	3-7
3.2.3	Front Panel Utility Connectors	3-8
3.2.3.1	Ext Ref, 50Ω BNC.....	3-8
3.2.3.2	IDR Alarms Connector, DB-15F	3-8
3.2.4	Front Panel Power Connections – Aux DC Inputs	3-8
3.3	Rear Panel Connectors	3-9
3.3.1	Rear Panel IF Connectors – Receive IF and Transmit IF A/B, 50Ω BNC.....	3-9
3.3.2	Rear Panel Terrestrial Data Connectors	3-10
3.3.2.1	Balanced G.703 A and B Connectors, DB-15M.....	3-10
3.3.2.2	Audio A and B Connectors, DB-9F.....	3-11
3.3.2.3	Overhead Data A and B Connectors, DB-25M.....	3-12
3.3.2.4	Data Interface A and B Connectors, DB-25F	3-13
3.3.3	Rear Panel Utility Connectors	3-14
3.3.3.1	IDR Alarms A and B Connectors, DB-15F	3-14
3.3.3.2	Aux Serial A and B Receptacles, USB Type ‘A’	3-14
3.3.3.3	Ext Ref A and B Connectors, 50Ω BNC	3-15
3.3.4	Ground Connection	3-15
3.4	Data Interface Converter Modules / Adapters.....	3-15
3.4.1	CIC-20 HSSI Connector, HD-50F.....	3-16
3.4.2	CIC-35 ASI Connectors, 75Ω BNC	3-16
3.4.3	E1/T1 RJ-48 Connection via Balanced G.703 Interface Connector.....	3-17

CHAPTER 4. CABLES AND CONNECTIONS	4-1
4.1 Overview	4-1
4.2 Cabling to the CDM-600	4-2
4.2.1.1 CRS-150 Accessories	4-2
4.2.2 Modem-to-Switch Control Interface Connection	4-3
4.2.3 Modem-to-Switch IF Interface Connection.....	4-4
4.2.4 Modem-to-User Utility Interface Connection and Examples.....	4-5
4.2.4.1 IDR Alarms Data Interface Example.....	4-5
4.2.4.2 External Reference Data Interface Example.....	4-6
4.2.5 Modem-to-User Data Interface Connection and Examples.....	4-7
4.2.5.1 RS-422/232 Interface Example.....	4-8
4.2.5.2 HSSI Data Interface Example.....	4-9
4.2.5.3 G.703 Balanced Interface Example	4-10
4.2.5.4 G.703 Unbalanced Interface Example	4-11
4.2.5.5 ASI Data Interface Example	4-12
4.2.5.6 E1/T1 Data Interface Example.....	4-13
4.2.5.7 Overhead Data Interface Example	4-14
4.2.5.8 Audio Data Interface Example.....	4-15
4.3 Cabling to the CDM-600L (CLM-9600L).....	4-16
CHAPTER 5. MODEM AND SWITCH CONFIGURATION	5-1
5.1 Overview	5-1
5.2 Configuration of CDM-600s for 1:1 Redundancy.....	5-2
5.2.1 Automatic Redundant Operation.....	5-2
5.2.2 Manual Redundant Operation (Forced Switchover).....	5-3
5.2.2.1 Forced Switchover via the CDM-600 Front Panel.....	5-3
5.2.2.2 Forced Switchover via Remote Bus.....	5-3
5.2.3 Replacement of Standby Unit.....	5-3
5.3 CRS-150 Switch DIP Settings	5-4
APPENDIX A. CABLE DRAWINGS	A-1
A.1 Introduction.....	A-1
A.2 Control Interface Cables	A-1
A.2.1 Modem-to-Switch Auxiliary Serial Cable (1:1 Control), USB Type A → USB Type B ...	A-2
A.2.2 Modem-to-Switch (CRS-150 → CRS-170A) Control/Data ‘Y’ Cable, DB-25M → DB-25M, DB-9M (CDM-600L [CDM-9600L]).....	A-3
A.3 IF / Utility / Data Interface Cables	A-4
A.3.1 Modem-to-Switch/User IF (70/140 MHz) Coax Cable, Type ‘BNC’ 50Ω.....	A-5
A.3.2 Modem-to-Switch Data Cable, DB-15M → DB-15M	A-6
A.3.3 Modem-to-Switch Coax Cable, Type ‘BNC’ 75Ω.....	A-7
A.3.4 Modem-to-Switch Universal Control/Data Cable, DB-25M → DB-25M	A-8

A.3.5 Modem-to-Switch Universal Control/Data Cable, DB-15M → DB-15M A-9
A.3.6 Modem-to-Switch Data Cable, DB-25M → DB-25M A-10
A.3.7 Modem-to-Switch Data Cable, DB-9M → DB-9M A-11

TABLES

Table 3-1. CRS-150 External Connectors (Front and Rear Panel) 3-2
Table 5-1. CRS-150 DIP Switch Settings 5-4

FIGURES

Figure 1-1. CRS-150 1:1 Redundancy Switch 1-1
Figure 1-2. CRS-150 1:1 Redundancy Switch – Panel Views 1-2
Figure 1-3. CRS-150 Dimensional Envelope 1-7
Figure 2-1. Unpacking and Inspecting the Shipment 2-1
Figure 2-1. Typical CDM-600/CRS-150 1:1 Redundancy Installation 2-2
Figure 3-1. CRS-150 Connectors 3-1
Figure 3-2. CN-0000268 DB-15M → RJ-48F Adapter for E1/T1 Operation 3-17
Figure 4-1. Modem-to-Switch Control Connection 4-3
Figure 4-2. Modem-to-Switch IF Connection 4-4
Figure 4-3. IDR Alarms Interface Example 4-5
Figure 4-4. Ext Ref (External Reference) Interface Example 4-6
Figure 4-5. CDM-600 Block Diagram: User → Modem → Switch → Traffic 4-7
Figure 4-6. RS-422/232 Interface Example 4-8
Figure 4-7. HSSI Example 4-9
Figure 4-8. G.703 Balanced Interface Example 4-10
Figure 4-9. G.703 Unbalanced Interface Example 4-11
Figure 4-10. ASI Example 4-12
Figure 4-11. G.703 E1/T1 Interface Example 4-13
Figure 4-12. Overhead Interface Example 4-14
Figure 4-13. Audio Interface Example 4-15
Figure 4-14. CDM-600L (CLM-9600L) Block Diagram: Cable Connections 4-16
Figure 5-1. CDM-600 Front Panel 5-2
Figure 5-2. CRS-150 Front Panel – DIP Switches 5-4
Figure A-1. Auxiliary Serial Control Cable (CEFD P/N CA/USB-AM/BM-3) A-2
Figure A-2. Data / Control ‘Y’ Cable (CEFD P/N CA/WR10456-4) A-3
Figure A-3. Tx/Rx/User Data Type ‘BNC’ 50Ω Coax Cable (CEFD P/N PL/0946-1) A-5
Figure A-4. IDR Alarms Interface Cable (CEFD P/N CA/WR9564-4) A-6
Figure A-5. External Reference Type ‘BNC’ 75Ω Coax Cable (CEFD P/N PL/0813-4) A-7
Figure A-6. 1:1 Universal Control/Data Cable (CEFD P/N PL/6233) A-8
Figure A-7. 1:1 Universal Control/Data Cable (CEFD P/N CA/WR9563-4) A-9
Figure A-8. Overhead Data Cable (CEFD P/N CA/WR9040-4) A-10
Figure A-9. Audio Data Interface Cable (CEFD P/N CA/WR9378-4) A-11

PREFACE

About this Manual

This manual provides installation and operation information for the Comtech EF Data CRS-150 1:1 Redundancy Switch, used for 1:1 Redundancy operations with the CDM-600 Satellite Modem. This is a technical document intended for the persons responsible for the operation and maintenance of the CRS-150 and CDM-600.

Reporting Comments or Suggestions Concerning this Manual

Comments and suggestions regarding the content and design of this manual are appreciated. To submit comments, please contact the Comtech EF Data Technical Publications Department:

TechnicalPublications@comtechefdata.com.

Related Documents

- *Comtech EF Data CDM-600/600L Satellite Modem Installation and Operation Manual*
- *Comtech EF Data CIC-20 LVDS to HSSI Interface Converter Installation and Operation Manual*
- *Comtech EF Data CIC-35 LVDS to ASI Interface Converter Installation and Operation Manual*

Conventions and References

Warnings, Cautions, and Notes



A **WARNING** gives information about a possible hazard that **MAY CAUSE DEATH or SERIOUS INJURY**.



A **CAUTION** gives information about a possible hazard that **MAY CAUSE INJURY or PROPERTY DAMAGE**.



A **NOTE** gives important information about a task or the equipment.



A **REFERENCE** directs the user to additional information about a task or the equipment.

Metric Conversion

Metric conversion information is located on the inside back cover of this manual. This information is provided to assist the operator in cross-referencing non-metric to metric conversions.

Recommended Standard Designations

Recommended Standard (RS) Designations have been superseded by the new designation of the Electronic Industries Association (EIA). References to the old designations are shown only when depicting actual text displayed on the screen of the unit (RS-232, RS-485, etc.). All other references in the manual will be shown with the EIA designations (EIA-232, EIA-485, etc.) only.

Trademarks

All product names mentioned in this manual may be trademarks or registered trademarks of their respective companies and are hereby acknowledged.



Carefully review the information that follows.

Electromagnetic Compatibility (EMC) Compliance

This is a Class B product. In a domestic environment, it may cause radio interference that requires the user to take adequate protection measures.

EN 55022-1997 Compliance

This equipment meets the radio disturbance characteristic specifications for information technology equipment as defined in EN 55022-1997.

EN 50082-1:1998 Compliance

This equipment meets the Electromagnetic Compatibility: Generic Immunity standard as defined in EN50082-1:1998.

In order that the CRS-150 continues to comply with these standards, observe the following instructions:

- Connections to the transmit and receive IF ports (BNC female connectors) should be made using a good quality coaxial cable; for example, RG58/U (50Ω) or RG59/U (75Ω).
- All 'D' type connectors attached to the unit must have back-shells that provide continuous metallic shielding. Cable with a continuous outer shield (either foil or braid, or both) must be used, and the shield must be bonded to the back-shell.
- The equipment must be operated with its cover on at all times. If it becomes necessary to remove the cover, the user should ensure that the cover is correctly refitted before normal operation commences.

Safety Compliance

EN 60950

Applicable testing is routinely performed as a condition of manufacturing on all units to ensure compliance with safety requirements of safety standard **EN 60950 Safety of Information Technology Equipment including Electrical Business Machines**.

This equipment meets the Safety of Information Technology Equipment specification as defined in EN 60950.

Electrical Safety

The equipment is rated for operation at +12 volts DC and -12 volts DC. It has a maximum power consumption of 4.5 Watts, and draws a maximum of 250 mA at +12 volts DC and 120 mA at -12

volts DC. The power supply current is, in all circumstances, supplied by either a single Comtech EF Data CDM-600 Satellite Modem, or a pair of these modems.





Equipment Connection

The CRS-150 is designed for operation **ONLY** with the Comtech EF Data CDM-600 Satellite Modems. These modems supply DC operating current (electronically fused and protected) and control signals for the correct functioning of this unit. Connection to other manufacturers' equipment could result in damage to the unit. The CRS-150 is not compatible with other Comtech EF Data modems not listed in this manual.

European Low Voltage Directive (LVD)

The following information is applicable for the European Low Voltage Directive (2006/95/EC):

Symbol	Description
<HAR>	Type of power cord required for use in the European Community.
	CAUTION: Double-pole/Neutral Fusing ACHTUNG: Zweipolige bzw. Neutraleiter-Sicherung

International Symbols			
Symbol	Definition	Symbol	Definition
	Alternating Current		Protective Earth
	Fuse		Chassis Ground



For additional symbols, refer to Warnings, Cautions, and Notes listed earlier in this Preface.

Federal Communications Commission (FCC)

This equipment has been tested and found to comply with the limits for a Class B digital device, pursuant to Part 15 Subpart B of the FCC rules. These limits are designed to provide reasonable protection against harmful interference when the equipment is operated in a commercial environment.

This equipment generates, uses, and can radiate radio frequency energy. If not installed and used in accordance with the instruction manual, it may cause harmful interference to radio communications. Operation of this equipment in a residential area is likely to cause harmful interference; in which case, users are required to correct the interference at their own expense.



To ensure compliance, properly shielded cables for DATA I/O must be used. More specifically, these cables must be shielded from end to end, ensuring a continuous shield.

Telecommunications Terminal Equipment Directive

In accordance with the Telecommunications Terminal Equipment Directive 91/263/EEC, this equipment should not be directly connected to the Public Telecommunications Network.

Environmental

The CRS-150 must not be operated in an environment where the unit is exposed to extremes of temperature outside the ambient range 0° to 50° C (32° to 122° F); precipitation, condensation, or humid atmospheres above 95% RH; altitudes (un-pressurized) greater than 2000 meters; excessive dust or vibration; flammable gases; and corrosive or explosive atmospheres.

Warranty Policy

Comtech EF Data products are warranted against defects in material and workmanship for a specific period from the date of shipment, and this period varies by product. In most cases, the warranty period is two years. During the warranty period, Comtech EF Data will, at its option, repair or replace products that prove to be defective. Repairs are warranted for the remainder of the original warranty or a 90 day extended warranty, whichever is longer. Contact Comtech EF Data for the warranty period specific to the product purchased.

For equipment under warranty, the owner is responsible for freight to Comtech EF Data and all related customs, taxes, tariffs, insurance, etc. Comtech EF Data is responsible for the freight charges only for return of the equipment from the factory to the owner. Comtech EF Data will return the equipment by the same method (i.e., Air, Express, Surface) as the equipment was sent to Comtech EF Data.

All equipment returned for warranty repair must have a valid RMA number issued prior to return and be marked clearly on the return packaging. Comtech EF Data strongly recommends all equipment be returned in its original packaging.

Comtech EF Data Corporation's obligations under this warranty are limited to repair or replacement of failed parts, and the return shipment to the buyer of the repaired or replaced parts.

Limitations of Warranty

The warranty does not apply to any part of a product that has been installed, altered, repaired, or misused in any way that, in the opinion of Comtech EF Data Corporation, would affect the reliability or detracts from the performance of any part of the product, or is damaged as the result of use in a way or with equipment that had not been previously approved by Comtech EF Data Corporation.

The warranty does not apply to any product or parts thereof where the serial number or the serial number of any of its parts has been altered, defaced, or removed.

The warranty does not cover damage or loss incurred in transportation of the product.

The warranty does not cover replacement or repair necessitated by loss or damage from any cause beyond the control of Comtech EF Data Corporation, such as lightning or other natural and weather related events or wartime environments.

The warranty does not cover any labor involved in the removal and or reinstallation of warranted equipment or parts on site, or any labor required to diagnose the necessity for repair or replacement.

The warranty excludes any responsibility by Comtech EF Data Corporation for incidental or consequential damages arising from the use of the equipment or products, or for any inability to use them either separate from or in combination with any other equipment or products.

A fixed charge established for each product will be imposed for all equipment returned for warranty repair where Comtech EF Data Corporation cannot identify the cause of the reported failure.

Exclusive Remedies

Comtech EF Data Corporation's warranty, as stated is in lieu of all other warranties, expressed, implied, or statutory, including those of merchantability and fitness for a particular purpose. The buyer shall pass on to any purchaser, lessee, or other user of Comtech EF Data Corporation's products, the aforementioned warranty, and shall indemnify and hold harmless Comtech EF Data Corporation from any claims or liability of such purchaser, lessee, or user based upon allegations that the buyer, its agents, or employees have made additional warranties or representations as to product preference or use.

The remedies provided herein are the buyer's sole and exclusive remedies. Comtech EF Data shall not be liable for any direct, indirect, special, incidental, or consequential damages, whether based on contract, tort, or any other legal theory.

Customer Support



Refer to p. xi in this Preface for information regarding this product's Warranty Policy.

Contact the Comtech EF Data Customer Support Department for:

- Product support or training
- Reporting comments or suggestions concerning manuals
- Information on upgrading or returning a product

A Customer Support representative may be reached during normal business hours at:

Comtech EF Data
Attention: Customer Support Department
2114 West 7th Street
Tempe, Arizona 85281 USA

480.333.2200 (Main Comtech EF Data number)
480.333.4357 (Customer Support Desk)
480.333.2161 FAX

To return a Comtech EF Data product (in-warranty and out-of-warranty) for repair or replacement:

- **Contact** the Comtech EF Data Customer Support Department during normal business hours. Be prepared to supply the Customer Support representative with the model number, serial number, and a description of the problem.
- **Request** a Return Material Authorization (RMA) number from the Comtech EF Data Customer Support representative.
- **Pack** the product in its original shipping carton/packaging to ensure that the product is not damaged during shipping.
- **Ship** the product back to Comtech EF Data. (Shipping charges should be prepaid.)

Online Customer Support

An **RMA number** can be requested electronically by accessing Comtech EF Data's online **Support** page (www.comtechefdata.com/support.asp). From this page:

- **Click** the **Service** hyperlink, then read the **Return Material Authorization** section for detailed instructions on Comtech EF Data's return procedures.
- **Click** [**Send RMA Request**] on the **Support** page or the **RMA Request** hyperlink provided in the **Service | Return Material Authorization** section; fill out the *Billing Information*, *Return Information*, and *Unit to be Returned* sections completely, then click [**Send email**].

– or –

- **Send an e-mail** providing this same detailed information to the Customer Support Department at service@comtechefdata.com.

Chapter 1. INTRODUCTION

1.1 Overview

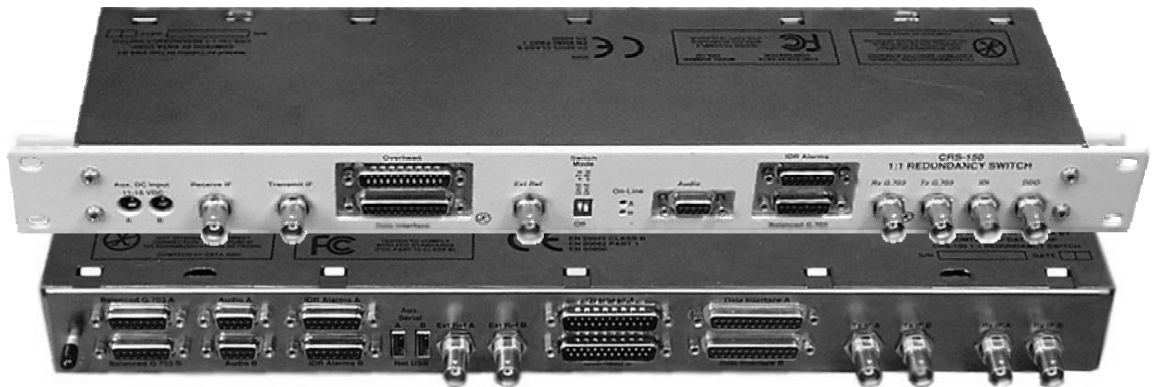

Figure 1-1. CRS-150 1:1 Redundancy Switch

The CRS-150 1:1 Redundancy Switch module, shown in **Figure 1-1**, is a companion product for use with the CDM-600 Satellite Modem.

Designed to continuously monitor a pair of modems (Units 'A' and 'B') in a 1:1 redundant configuration, the CRS-150 automatically switches data and IF signals from the failed *online* modem to the *standby* modem in the event of an equipment failure or undesired traffic condition. Traffic paths are fully protected, and the system operator can have increased confidence that equipment failures will not adversely affect system availability.

A 1:1 redundancy system comprises an online modem, a redundant (standby) modem, and the CRS-150 1:1 Redundancy Switch. Note that the CRS-150 is intended for mounting at the *rear* of a pair of modems in a 19" rack system.



The CRS-150 is an accessory product designed specifically for the Comtech EF Data CDM-600 modem, and must not be used with any other equipment.



For correct operation of the CRS-150, the CDM-600 modems must have Firmware Version 1.1.0 (or higher). If the modems do not meet this requirement, please contact Comtech EF Data Customer Support to arrange to receive a free Flash upgrade.

1.2 Description of Features

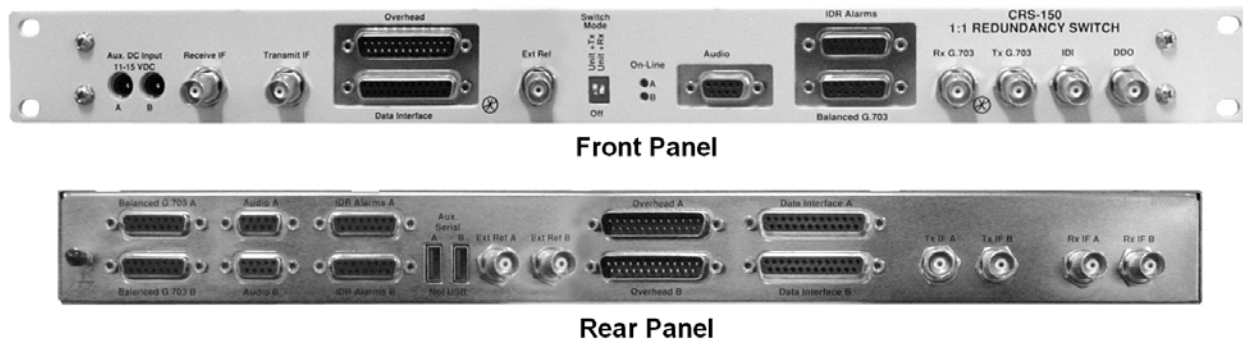

Figure 1-2. CRS-150 1:1 Redundancy Switch – Panel Views

Figure 1-2 illustrates the operational features available on the front and rear panels of the CRS-150 1:1 Redundancy Switch.

The CRS-150 includes, as standard, a universal data interface, which eliminates the need to exchange interface cards for different applications. Supported interfaces include:

- EIA-422 (EIA530) DCE
- V.35 DCE (at rates up to 10 Mbps)
- Synchronous EIA-232 DCE (at rates up to 300 kbps)
- LVDS (at rates up to 20 Mbps)
- Balanced and Unbalanced G.703 at rates up to E2 (8.448 Mbps)

Because CDM-600 operational details are not covered in this manual, the user should refer to the *Comtech EF Data CDM-600/600L Satellite Modem Installation and Operation Manual* as needed to become familiar with all aspects of the modem before attempting redundant operations.

For Drop and Insert (D&I) applications, the second G.703 port (T1 or E1) found on the rear panel of the CDM-600 is also provided. The operator does not have to configure the interface type – control signals from the modems automatically perform the selection.

Clock and data signals in the transmit direction are buffered and fed to both modems in the pair simultaneously. The Receive IF signal is split and fed to both modems. This means that both modems see identical Tx and Rx traffic signals all the time, which permits the CRS-150 to continually compare the fault status of both modems. If the CRS-150 sees an identical fault on both modems at the same time, it will infer that the fault condition exists in the external system, and eliminate an unnecessary switchover.

Only one modem in the pair (the online unit) is permitted to transmit its IF carrier signal at any one instance. For total security, the offline modem mutes its Tx carrier, and the CRS-150 provides further isolation by using an RF relay within the unit. Unlike some other 1:1 redundancy systems, which use a passive power combiner for this function (losing approximately 3.5 dB in output power level), the CRS-150 does not introduce any significant attenuation of output signal level.

As a companion product for the CDM-600, the CRS-150 provides full protection for *all* Open Network overhead signals (IDR Backward Alarms, Overhead Data Channels, Audio, etc.), as well as external reference signals.

An advantage of the CRS-150 redundancy system is the Auxiliary Serial connection between the modem pair. With the appropriate cables connecting the modems to the CRS-150, the online unit interrogates the standby unit, at regular intervals, to determine its configuration. If a difference in configuration is detected, the online unit automatically reconfigures the standby unit so that the configurations are always synchronized. If the standby unit is replaced, it does not have to be reprogrammed to match the online unit; the process is entirely automatic.

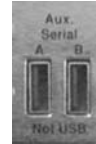

Operators can manually force a switchover from the front panel of the online modem, or via the remote control bus. Alternatively, operators may choose the conditions that will cause an automatic switchover. Automatic switchover conditions are controlled by two switches located on the front panel of the unit – this provides a great deal of flexibility in switch operation. Switch Mode choices are: Unit Faults only; Unit + Transmit Traffic Faults; Unit + Receive Traffic Faults; or Unit + Transmit + Receive Faults.



For operation at the maximum data rate of 20 Mbps, the CDM-600 uses a serial LVDS interface. However, many applications, including high-speed routers, use the popular HSSI interface (using negative ECL levels). For these applications, the Comtech EF Data CIC-20 LVDS to HSSI Interface Converter module is available.



Also available, for conversion of LVDS to ASI, is the Comtech EF Data CIC-35 LVDS to ASI Interface Converter module.

Either module typically connects directly to the rear of a standalone CDM-600. For CDM-600s used in redundancy with a CRS-150, however, either module plugs into the Overhead / Data Interface connector set on the front panel of the CRS-150.



Like the CRS-150, the CIC-20 and CIC-35 take their operating power directly from the modem. However, the CDM-600 modem can safely supply enough current for only one attached device, not two. Therefore, when connecting a CIC-20 or CIC-35 to the CRS-150, also connect an external supply (or supplies) to the CRS-150. This low-current DC supply, located on the front panel, provides DC voltage between 11 and 15 volts. While a single supply may be used, for maximum reliability a second diode-shared input is provided and use of both 'A' and 'B' supplies is recommended.

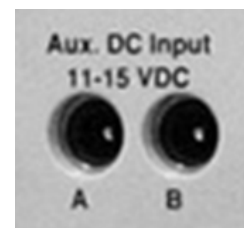

The CIC-20 or CIC-35 module, when either is used, plugs directly into the CRS-150 front panel – do NOT use a cable for either module.

1.3 Functional Description

The CRS-150 connects to two modems – the online modem (identified for the purpose of this example as Unit ‘A’), and the redundant (standby) modem (Unit ‘B’). The CRS-150 monitors the fault status and controls the routing of data and IF signals to and from these two modems. In the case of an equipment failure, switching automatically takes place to protect the traffic circuit.

At the heart of the CRS-150 is a Controller State Machine. Implemented in a complex programmable logic device (CPLD), it is responsible for fault monitoring and control of switching functions.

The CRS-150 derives its operating power from the Unit ‘A’ and Unit ‘B’ modems. A diode-sharing arrangement with a current-sharing circuit ensures that, in normal operation, power is taken equally from the two modems. However, in the event that one of the two units is removed, the remaining modem can supply all of the current requirement.

The modems supply +12 volts DC (at a combined total of 250 mA max) and -12 volts DC (at a combined total of 120 mA max). Maximum power consumption occurs in a serial LVDS mode at maximum data rate (20 Mbps). Power consumption in EIA-232 modes is approximately 40% of the maximum values. The modem employs electronic fuses, which prevent excessive current from being drawn by the CRS-150, should an anomalous condition occur.

Transmit Clock and Data signals entering the unit via the Data Interface are buffered and fed to both units simultaneously. This ensures that the standby unit sees the same traffic conditions as the online unit. Receive Data and Clock signals coming from the online modem are routed, using signal relays, to the Data Interface. In the event that a switchover occurs, these relays switch so the standby unit then supplies the Data and Clock signals.

As only one modem in the pair (the online unit) is permitted to transmit its IF carrier signal at any one instant, the standby unit is forced to disable its TX carrier by asserting the TX Carrier Off signal at the Data Interface. In addition, the CRS-150 provides further isolation (and security) by using an RF relay within the unit. Unlike some other 1:1 redundancy systems that use a passive power combiner on the two Tx IF ports (and hence lose approximately 3.5 dB in output power level) the CRS-150 does not introduce any significant attenuation of output signal level.

The Receive IF signal is fed to both units simultaneously using an internal power divider. This does introduce a loss of approximately 3.5 dB but, given the wide dynamic range of the demodulator in the CDM-600, this is not considered to be a problem. The advantage of this scheme is that the demodulators in both the online and standby units are locked; therefore, if a switchover does occur there will be no delay while waiting for the demodulator to acquire lock – this greatly speeds the time for the switchover to occur.

Fault status information is fed from each of the two modems via the Data Interface connector. The Controller State Machine decides, based on the fault status, which of the two modems – Unit ‘A’ or Unit ‘B’ – is to be the online modem. It will assert a control signal to the standby modem, which mutes its Tx IF carrier, and simultaneously indicates to the microcontroller within the standby unit that the modem is no longer online. This results in the “ON LINE” LED on the now-offline modem’s front panel being extinguished. This status is also reported over the remote control bus, so an external M&C system can determine the state of the redundancy system. At the

same time, the “On-Line” LED – i.e., the *green* Unit ‘A’ LED or the *yellow* Unit ‘B’ LED – will illuminate on the CRS-150 front panel to indicate which modem is online.

1.4 Summary of Specifications

Equipment Type	1:1 Redundancy Switch
Modems Supported	Comtech EF Data CDM-600 Digital Satellite Modem
Operating Modes	<ul style="list-style-type: none"> Fully Automatic Manual (via the front panel of the Online Modem, or via the Modem’s remote control interface)
Architecture	<ul style="list-style-type: none"> Full bridging architecture, with configuration synchronization Tx Clock and Data signals fed to both Online and Standby units Rx IF signal fed to both Online and Standby units Continuous fault comparison of Online and Standby units (The configuration of Online and Standby units is synchronized via the Auxiliary Serial link between the two Modems)
Switch Conditions	Switchover initiated following: <ul style="list-style-type: none"> Unit faults only, or: Unit faults or Receive Traffic Faults, or: Unit faults or Transmit Traffic Faults, or: Unit faults or Receive or Transmit Traffic Faults
Fault detection time	1 second maximum
Switchover time	Within 0.5 seconds of fault detection
Main Data Interfaces	<ul style="list-style-type: none"> RS422/EIA530 DCE (25 pin D-type female, pinout per EIA530) to 10 Mbps V.35 DCE to 10 Mbps Synchronous RS232 to 300 kbps Serial LVDS to 20 Mbps A standard HSSI interface is provided with the addition of the optional Comtech CIC-20 LVDS/HSSI Interface Converter module, for operation up to 20 Mbps
G.703 Interfaces	<ul style="list-style-type: none"> G.703, T1, E1, T2 and E2, balanced and unbalanced (BNC connectors for 75Ω unbalanced, and 15 pin D-type for 120Ω balanced) Note that for T1 and E1 Drop and Insert applications the unit supports Rx, Tx connections, as well as Drop Data Out (DDO) and Insert Data In (IDI) ‘G.703-like’ signals at 512 kbps and 1024 kbps (through DDO and IDI ports)
Overhead Interface	Intelsat IESS-308/309/310 Open Network overhead signals, including: <ul style="list-style-type: none"> IDR Overhead Data Channels (64 kHz, 8kHz, and Octet clocks) IBS ESC and High-Rate ESC Balanced External Reference Input IDR Backward Alarm Inputs (25 pin D-type male)
Audio	2 x 4-wire 600 Ω audio interface, per Intelsat IESS-308 (9 pin D-type female)
IDR Backward Alarms	Backward Alarm Outputs BA-1 through BA-4 (Form C relays) per Intelsat IESS-308 (15 pin D-type female)
External Reference	<ul style="list-style-type: none"> 75Ω BNC, unbalanced input 120Ω balanced input

IF Switching/ Splitting	<ul style="list-style-type: none">• Transmit IF: Switched by RF relay (0.3 dB max loss)• Receive IF: Passive power splitting (3.5 dB max loss)
IF Impedance	<ul style="list-style-type: none">• Optimized for 50Ω (> 20 dB return loss on external IF ports)• 75Ω supported with the use of external RF transformers (supplied)
IF Connectors	BNC female
IF Frequency range	52-176 MHz
Weight	4.6 lbs (2.1 kg)
Dimensions	1.75 inches (44.5 mm) high, 19 inches (482.5 mm) wide, 4.2 inches (107 mm) deep (excluding connectors)
Power requirements	<p>4.5 Watts maximum + 12 volts DC @ 250 mA (max) -12 volts DC @ 120 mA (max)</p> <ul style="list-style-type: none">• Power is supplied by the Online and Standby Modems, and the unit current shares when both an >A= and >B= unit are present. These power supplies are electronically fused and protected.• A pair of auxiliary DC inputs are provided for powering external equipment connected to the main data interface, such as a CIC-20 Interface Converter.
Approvals	<ul style="list-style-type: none">• 'CE' as follows:<ul style="list-style-type: none">○ EN 55022 Class B (Emissions)○ EN 50082-1 (Immunity)○ EN 60950 (Safety)• FCC Part 15 Class B

1.5 Dimensional Envelope

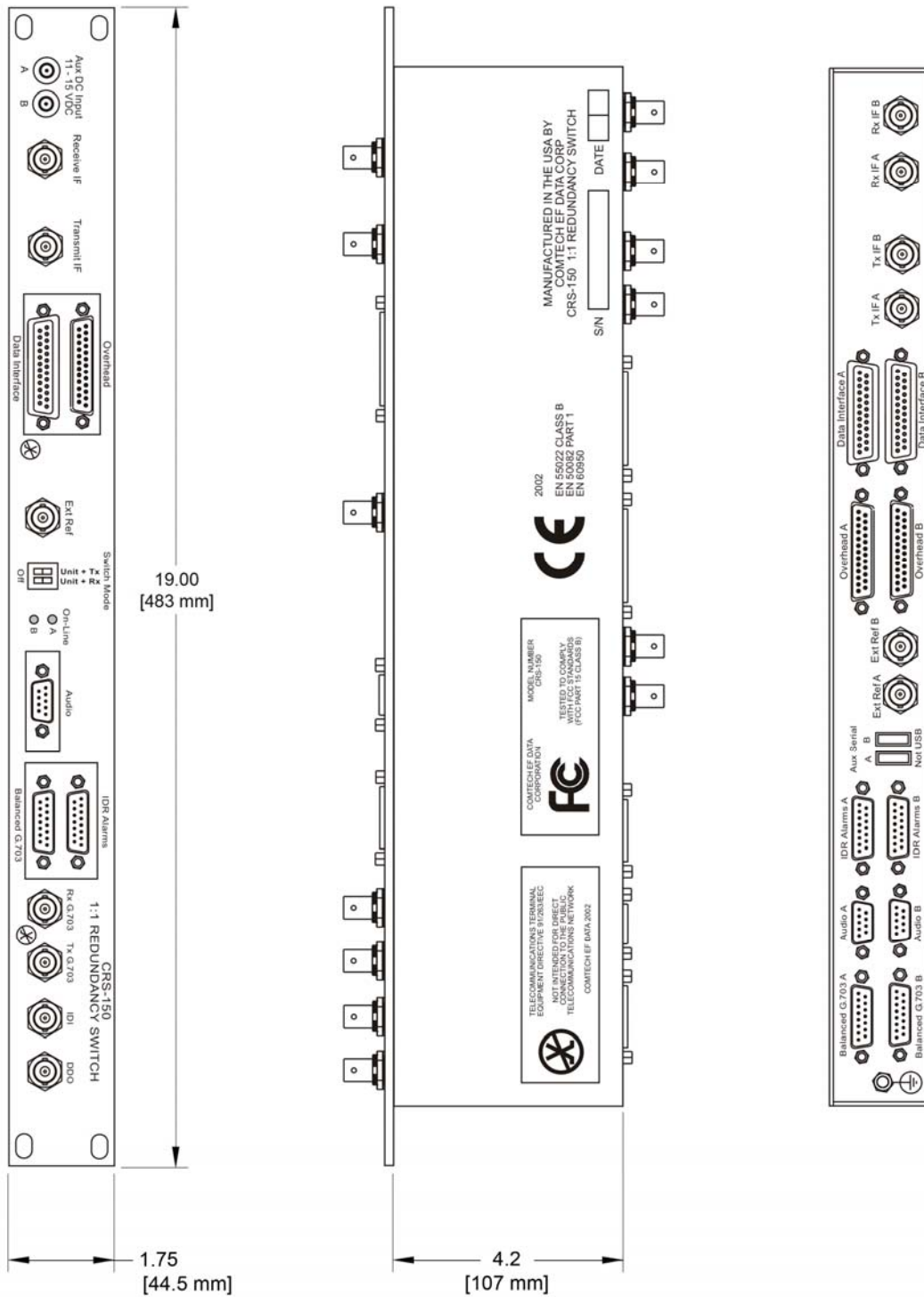

Figure 1-3. CRS-150 Dimensional Envelope

Chapter 2. INSTALLATION

2.1 Unpacking and Inspecting the Shipment

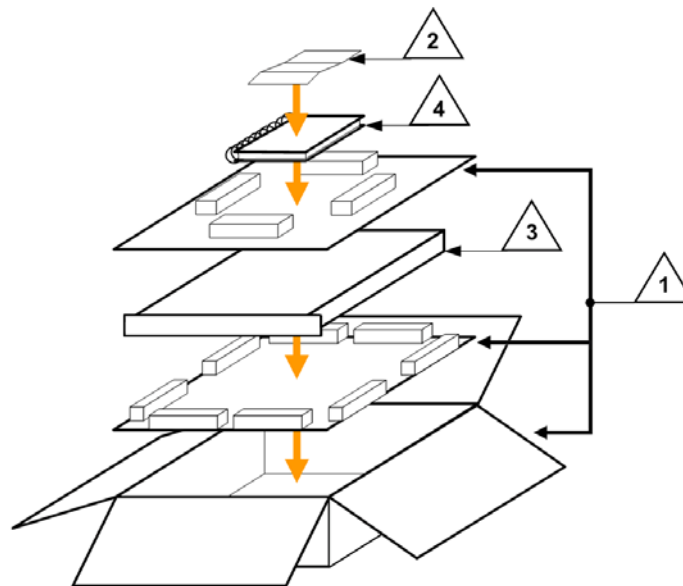

Figure 2-1. Unpacking and Inspecting the Shipment

The CRS-150 1:1 Redundancy Switch and its Installation and Operation Manual were packaged and shipped in a reusable cardboard carton containing protective foam spacing.





This equipment contains parts and assemblies sensitive to damage by Electrostatic Discharge (ESD). Use ESD precautionary procedures when handling the equipment.



Once opened, inspect the shipment:

Step	Task
1	Keep all shipping materials for storage or reshipment.
2	Check the packing list to ensure the shipment is complete.

- 3 Inspect the equipment for any possible damage incurred during shipment. Contact the carrier and Comtech EF Data immediately to submit a damage report if damage is evident.
- 4  Review the **Installation and Operation Manual** carefully to become familiar with operation.
- 5  Proceed to **Section 2.2 Rack-Mounting the CRS-150**.

2.2 Rack-Mounting the CRS-150

The CRS-150 is designed to be mounted into the **rear** of a rack, **behind** the CDM-600 modems. This typical configuration is shown in **Figure 2-1**.

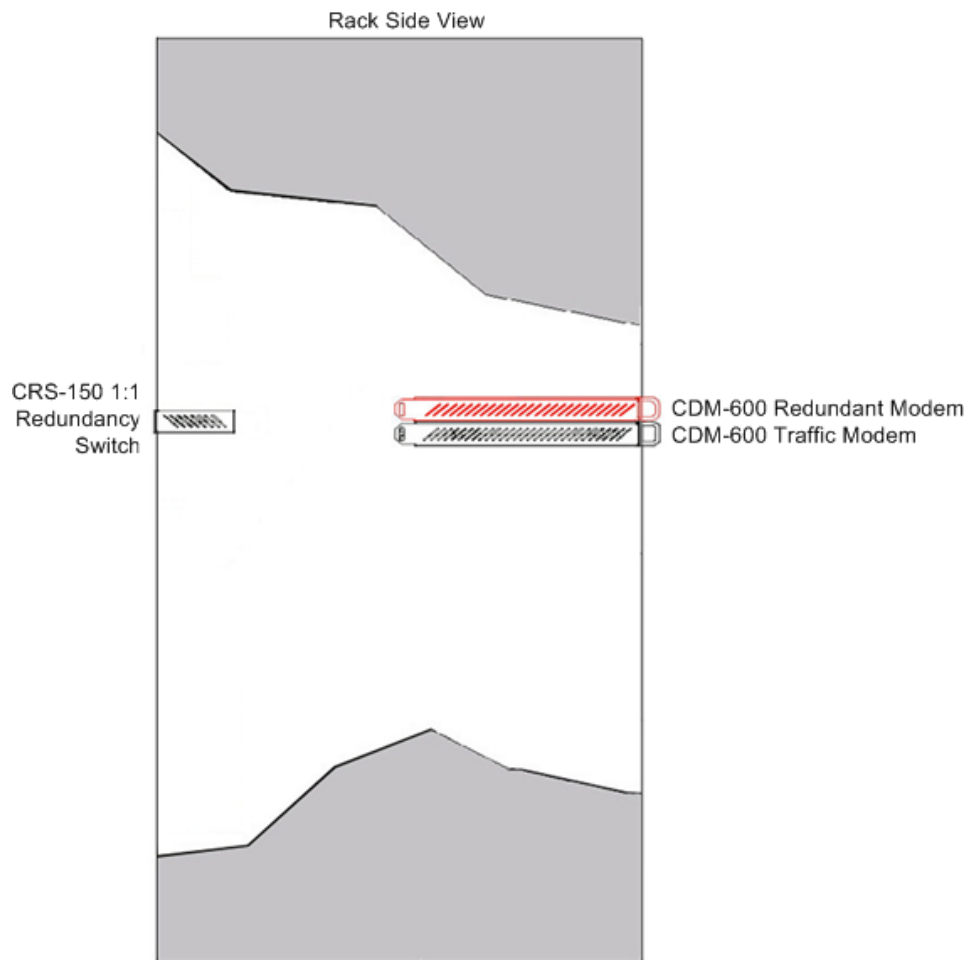

Figure 2-2. Typical CDM-600/CRS-150 1:1 Redundancy Installation

Once the CRS-150 has been installed into operating position, it will be ready for configuration and cabling connections. Please refer to **Chapter 4. MODEM AND SWITCH CONFIGURATION** and **Chapter 5. CABLES AND CONNECTIONS** for further information.

Chapter 3. CONNECTOR PINOUTS

3.1 Connector Overview

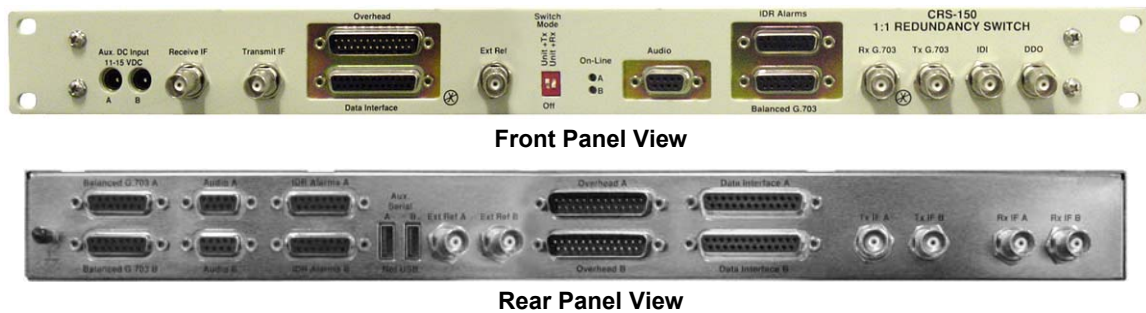

Figure 3-1. CRS-150 Connectors

The front and rear panels of the CRS-150 1:1 Redundancy Switch are shown in **Figure 3-1**.

The front panel connectors provide all necessary to connect all equipment external to the 1:1 redundancy setup. The rear panel connectors of the CRS-150 1:1 Redundancy Switch provide all the connections between the CRS-150 and the two CDM-600 modems in the 1:1 pair.

Also optionally available are two interface converter modules: The CIC-20, which converts LVDS to HSSI, and the CIC-35, which converts LVDS to ASI. Full information on either of these products is available from their respective operation manuals; for the purpose of this chapter, only the User Data Interface pinouts are documented.

On the next page, **Table 3-1** summarizes these connectors, grouped according to location (front, rear, or data interface) and service function.



The European EMC Directive (EN55022, EN50082-1) requires using properly shielded cables for DATA I/O. These cables must be double-shielded from end-to-end, ensuring a continuous ground shield.

Table 3-1. CRS-150 External Connectors (Front and Rear Panel)

Connector Group (Chapter 3 Sect. Ref.)		Name	Connector Type	Function		
Front Panel (Sect. 3.2)	IF (Sect. 3.2.1)	Receive IF	BNC 50Ω female	RF Input		
		Transmit IF	BNC 50Ω female	RF Output		
	Terrestrial Data (Sect. 3.2.2)	Overhead	25-pin Type 'D' male	Intelsat Overhead – 64kbps EIA-422, 1/16 IBS Overhead ESC @EIA-232; IDR Backward Alarm		
		Data Interface	25-pin Type 'D' female	Serial Synchronous Data Input/Output		
		Audio	9-pin Type 'D' female	ADPCM Audio Input/Output		
		G.703 Data	Balanced G.703	15-pin Type 'D' female	G.703 Balanced T1 (1.544 Mps) / E1 (2.048 Mbps) / T2 (6.312 Mbps)	
			Rx G.703	BNC 75Ω female	G.703 Unbalanced E1 (2.048 Mbps) Receive	
			Tx G.703	BNC 75Ω female	G.703 Unbalanced E1 (2.048 Mbps) Transmit	
			IDI	BNC 75Ω female	Insert Data In – G.703 Unbalanced E1 (2.048 Mbps)	
	DDO	BNC 75Ω female	Drop Data Out – G.703 Unbalanced E1 (2.048 Mbps)			
	Utility (Sect. 3.2.3)	Ext Ref	BNC 50Ω female	External Baseband Input		
		IDR Alarms	15-pin Type 'D' female	Form C Alarms (backward alarm outputs)		
	Power (Sect. 3.2.4)	Aux DC Input	2.1mm socket (11-15 VDC)	Power for External Devices		
Rear Panel (Sect. 3.3)	IF (Sect. 3.3.1)	Tx IF A	BNC female	RF Input		
		Tx IF B				
		Rx IF A	BNC female		RF Output	
		Rx IF B				
	Terrestrial Data (Sect. 3.3.2)	G.703 Data	Balanced G.703 A	15-pin Type 'D' male		G.703 Balanced T1 (1.544 Mps) / E1 (2.048 Mbps) / T2 (6.312 Mbps)
			Balanced G.703 B			
		Audio A	9-pin Type 'D' female	ADPCM Audio Input/Output		
		Audio B				
		Overhead A	25-pin Type 'D' male	Intelsat overhead – 64kbps EIA-422, 1/16 IBS overhead ESC @EIA-232; IDR backward alarm		
		Overhead B				
		Data Interface A	25-pin Type 'D' female	Serial synchronous data Input/Output		
	Data Interface B					
	Utility (Sect. 3.3.3)	IDR Alarms A	15-pin Type 'D' female	Form C Alarms (backward alarm outputs)		
		IDR Alarms B				
		Aux Serial A	USB Type 'A' female		Serial RS232 Input/Output	
		Aux Serial B				
		Ext Ref A	BNC 50Ω female		External Baseband Output	
		Ext Ref B				
	Ground (Sect. 3.3.4)	Ground	#10-32 stud	Common Chassis Ground		
	Interface Converters (Sect. 3.4)	CIC-20 (Sect. 3.4.1)	L VDS → HSSI Interface Converter Module	50-pin Type 'HD' female	HSSI data Input/Output	
CIC-35 (Sect. 3.4.2)		LVDS → ASI Interface Converter Module	BNC 75Ω female	ASI Input		
				ASI Output		
CA-0000268 (Sect. 3.4.3)	Adapter	DB-15F → RJ-48F	G.703 Balanced E1/T1			

3.2 Front Panel Connectors

Unless otherwise noted, the connectors featured on the front panel of the CRS-150 are intended for connection to all equipment external to the 1:1 redundancy setup.

3.2.1 Front Panel IF Connectors – Receive IF and Transmit IF, 50Ω BNC



The Receive IF and Transmit IF port connectors are both 50Ω Type ‘BNC’ female. The electrical impedance presented by these connectors is controlled internally by an RF-switching arrangement – this selection between 50Ω and 75Ω is controlled either via the CDM-600 front panel menus, or via the CDM-600 remote control bus.



The CRS-150 has been optimized to work with 50Ω systems, and it is very important that 50Ω cables are used between the CRS-150 and the traffic modems. For users with a 75Ω system, 50Ω-to-75Ω transformers are supplied with the CRS-150 that should be connected to the external IF ports.

3.2.2 Front Panel Terrestrial Data Connectors

3.2.2.1 Overhead Data Connector, DB-25M



The 25-pin 'D' Type male (DB-25M) Overhead data connector is used for passing components of Intelsat specified overhead frame structures. These include 64 kbps EIA-422 and 1/16 IBS overhead ESC at EIA-232. The IDR backward alarm inputs are found on this connector.

Overhead Data Connector (DB-25M)			
Pin #	Signal Function	Signal Name	Direction
14	IDR 64 kbps ESC TX Data +	TX-422DAT-B	In
2	IDR 64 kbps ESC TX Data -	TX-422DAT-A	In
12	IDR 64 kHz ESC TX Clock +	TX-422CLK-B	Out
15	IDR 64 kHz ESC TX Clock -	TX-422CLK-A	Out
11	IDR 1 kHz TX Octet Clock +	TX-OCT-B	Out
24	IDR 1 kHz TX Octet Clock -	TX-OCT-A	Out
16	IDR 64 kbps ESC RX Data +	RX-422DAT-B	Out
3	IDR 64 kbps ESC RX Data -	RX-422DAT-A	Out
9	IDR 64 kHz ESC RX Clock +	RX-422CLK-B	Out
17	IDR 64 kHz ESC RX Clock -	RX-422CLK-A	Out
19	IDR 1 kHz RX Octet Clock +	RX-OCT-B	Out
4	IDR 1 kHz RX Octet Clock -	RX-OCT-A	Out
20	Balanced Ext. Ref. Clock +	EXT-CLK-B	In
23	Balanced Ext. Ref. Clock -	EXT-CLK-A	In
13	IBS ESC RS232 TX Data	TX-232-DATA	In
22	IBS ESC RS232 TX Clock	TX-232-CLK	Out
8	IBS ESC RS232 RX Data	RX-232-DATA	Out
10	IBS ESC RS232 RX Clock	RX-232-CLK	Out
5	IBS TX High-Rate ESC Data	TX-ASYNC	In
6	IBS RX High-Rate ESC Data	RX-ASYNC	Out
1	IDR Back Alarm 1 H/W input	BW-IN1	In
18	IDR Back Alarm 2 H/W input	BW-IN2	In
21	IDR Back Alarm 3 H/W input	BW-IN3	In
25	IDR Back Alarm 4 H/W input	BW-IN4	In
7	Signal Ground	Ground	--

3.2.2.2 Data Interface Connector, DB-25F



The 25-pin 'D' Type female (DB-25F) Data Interface connector connects to customer's terrestrial equipment. It conforms to the EIA-530 pinout, which allows for connection of different electrical standards, including EIA-422, V.35, and EIA-232. A shielded 25-pin 'D' type connection provides a very solid solution to EMC problems, unlike the sometimes-used V.35 Winchester connector.



It is the user's responsibility to provide the appropriate cables to connect to this EIA-530 connector.

Data Interface Connector (DB-25F)						
Pin #	Generic Signal Description	Direction	EIA-422 EIA-530 LVDS	V.35	EIA-232	Circuit #
2	TX Data A	DTE to Modem	SD A	SD A	BA	103
14	TX Data B	DTE to Modem	SD B	SD B	--	103
24	TX Clock A	DTE to Modem	TT A	SCTE A	DA	113
11	TX Clock B	DTE to Modem	TT B	SCTE B	--	113
15	INT TX Clock A	Modem to DTE	ST A	SCT A	DB	114
12	INT TX Clock B	Modem to DTE	ST B	SCT B	--	114
3	RX Data A	Modem to DTE	RD A	RD A	BB	104
16	RX Data B	Modem to DTE	RD B	RD B	--	104
17	RX Clock A	Modem to DTE	RT A	SCR A	DD	115
9	RX Clock B	Modem to DTE	RT B	SCR B	--	115
8	Receiver Ready A	Modem to DTE	RR A	RLSD *	CF	109
10	Receiver Ready B	Modem to DTE	RR B	--	--	109
23	External Carrier Off (EIA-232 '1' or TTL 'low')	DTE to Modem	--	--	--	--
7	Signal Ground	--	SG	SG	AB	102
1	Shield	--	Shield	FG	AN	101

Notes:

1. Receiver Ready is an EIA-232 -level control signal on a V.35 interface.
2. **DO NOT connect signals to pins which are not shown - these pins are reserved for use by the redundancy system.**
3. 'B' signal lines are not used for EIA-232 applications.
4. For X.21 operation, use the EIA-422 pins, but ignore RX Clock if the Modem is DTE, and ignore TX clocks if the Modem is DCE.
5. For IDR operation using G.703, this primary interface becomes the 8 kbps EIA-422 overhead channel.

3.2.2.3 Audio Connector, DB-9F



The 9-pin 'D' Type female (DB-9F) Audio connector is used for the two 32 kbps ADPCM audio inputs and outputs (600Ω transformer coupled, balanced signals). These can be used for both ESC voice circuits in IDR mode, or as the primary data (**FAST** option).

Audio Connector (DB-9F)		
Pin #	Signal Function	Direction
1	Tx Audio 1 (+)	In
6	Tx Audio 1 (-)	In
2	Rx Audio 1 (+)	Out
7	Rx Audio 1 (-)	Out
8	Tx Audio 2 (+)	In
4	Tx Audio 2 (-)	In
9	Rx Audio 2 (+)	Out
5	Rx Audio 2 (-)	Out
3	Common	

3.2.2.4 G.703 Connectors

3.2.2.4.1 Balanced G.703 Interface Connector, DB-15F



The 15-pin 'D' Type female (DB-15F) P7 Balanced G.703 connection is used for balanced operation at the G.703 data rates of T1 (1.544 Mbps), E1 (2.048 Mbps), or T2 (6.312 Mbps).

Balanced G.703 Connector (DB-15F)			
Pin #	Signal Function	Name	Direction
1*	Drop Data Input (-)	DDI-	In
9*	Drop Data Input (+)	DDI+	In
2	Ground	GND	
10	Not Used		
3*	Insert Data Output (-)	IDO-	Out
11*	Insert Data Output (+)	IDO+	Out
4	Ground	GND	
12	Drop Data Output (-)	DDO-	Out
5	Drop Data Output (+)	DDO+	Out
13	Insert Data Input (-)	IDI-	In
6	Insert Data Input (+)	IDI+	In
14	Not Used		
7	Not Used		
15	Not Used		
8	Not Used		

*Use for all non-Drop and Insert and T2/E2 balanced applications.

3.2.2.4.2 Rx and Tx (Unbalanced) G.703 Connectors, 75Ω BNC



Two 75Ω BNC female connectors are provided for unbalanced operation at the G.703 data rates of E1 (2.048 Mbps), T2 (6.312 Mbps), or E2 (8448 kbps).

BNC Connector	Description	Direction
Rx G.703	Rx G.703 (Unbalanced E1)	Out
Tx G.703	Tx G.703 (Unbalanced E1)	In

3.2.2.4.3 IDI, DDO Connectors, 75Ω BNC



Two female BNC 75Ω connectors are provided for Drop and Insert (D&I) unbalanced operation at the G.703 data rate of E1 (2.048 Mbps). These are the Insert Data In (IDI) and Drop Data Out (DDO) ports.

BNC Connector	Description	Direction
IDI	Insert Data Input	In
DDO	Drop Data Output	Out

Another function of these connectors is for **auxiliary** G.703 data paths operating at 512, 1024, and 2048 kbps. When these rates are selected, the IDI port is the TX terrestrial G.703 input and the DDO port is the RX G.703 output.

3.2.3 Front Panel Utility Connectors

3.2.3.1 Ext Ref, 50Ω BNC



This is 50Ω BNC female connector is used for operating an external station reference. It requires an EIA-422 compatible level, so this unbalanced input should have a zero volt (0V) offset and a swing of at least $\pm 2V$ into the 120Ω termination provided.

3.2.3.2 IDR Alarms Connector, DB-15F



The 15-pin Type 'D' female (DB-15F) IDR Alarms interface connection provides four Form-C backward alarm outputs specified by Intelsat.

IDR Alarms Connector (DB-15F)		
Pin #	Signal Function	Name
2	Backward Alarm 1 is active	BA-1-NO
9		BA-1-COM
1	Backward Alarm 1 is not active	BA-1-NC
10	TBD	MON-A
4	Backward Alarm 2 is active	BA-2-NO
11		BA-2-COM
3	Backward Alarm 2 is not active	BA-2-NC
6	Backward Alarm 3 is active	BA-3-NO
13		BA-3-COM
5	Backward Alarm 3 is not active	BA-3-NC
14	TBD	MON-B
8	Backward Alarm 4 is active	BA-4-NO
15		BA-4-COM
7	Backward Alarm 4 is not active	BA-4-NC
12	Ground	GND

3.2.4 Front Panel Power Connections – Aux DC Inputs

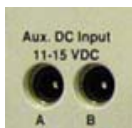

The front panel of the CRS-150 incorporates two independent DC inputs (using 2.1 mm sockets, with the outer conductor grounded). Comtech EF Data can supply the appropriate AC/DC supply, complete with IEC power input connector (Part number PS/AC18W01P01).

For more information about Comtech EF Data accessories that make use of this interface, see **Chapter 1. INTRODUCTION**.

3.3 Rear Panel Connectors

The rear panel connectors of the CRS-150 1:1 Redundancy Switch provide all the connections between the CRS-150 and the two CDM-600 modems in the 1:1 pair.



With the exception of the mandatory main connections between the 25-pin data ports (Overhead A/B, Data Interface A/B), the remaining connections are purely optional.

3.3.1 Rear Panel IF Connectors – Receive IF and Transmit IF A/B, 50Ω BNC

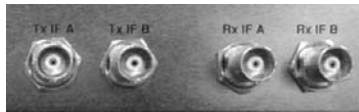

The Receive IF and Transmit IF A and B port connectors are all 50Ω Type ‘BNC’ female. The electrical impedance presented by these connectors is controlled internally by an RF-switching arrangement – this selection between 50Ω and 75Ω is controlled either via the CDM-600 front panel menus, or via the CDM-600 remote control bus.

Observe the following:

BNC Connector	Description	Direction
Tx IF A	RF Input	In
Tx IF B	RF Input	In
Rx IF A	RF Output	Out
Rx IF B	RF Output	Out



The CRS-150 has been optimized to work with 50Ω systems, and it is very important that 50Ω cables are used between the CRS-150 and the traffic modems. For users with a 75Ω system, 50Ω-to-75Ω transformers are supplied with the CRS-150 that should be connected to the external IF ports.

3.3.2 Rear Panel Terrestrial Data Connectors

3.3.2.1 Balanced G.703 A and B Connectors, DB-15M

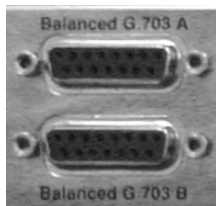

The 15-pin 'D' Type female (DB-15F) Balanced G.703 A and B connectors are used for balanced operation at the G.703 data rates of T1 (1.544 Mbps), E1 (2.048 Mbps), or T2 (6.312 Mbps).

Balanced G.703 A and B Connectors (DB-15F)			
Pin #	Signal Function	Name	Direction
1*	Drop Data Input (-)	DDI-	Out
9*	Drop Data Input (+)	DDI+	Out
2	Ground	GND	
10	Not Used		
3*	Insert Data Output (-)	IDO-	In
11*	Insert Data Output (+)	IDO+	In
4	Ground	GND	
12	Drop Data Output (-)	DDO-	In
5	Drop Data Output (+)	DDO+	In
13	Insert Data Input (-)	IDI-	Out
6	Insert Data Input (+)	IDI+	Out
14	Not Used		
7	Not Used		
15	Not Used		
8	Not Used		

*Use for all non-Drop and Insert and T2/E2 balanced applications.



In order to simplify the cabling between the CDM-600 modems and the CRS-150 Redundancy Switch, all G.703 signals are carried between modems and switch on the BALANCED connections, regardless of the choice of balanced/unbalanced connectors on the CRS-150 front panel.

The user should not be concerned about this – the modem signals the appropriate port type (balanced or unbalanced) to the CRS-150, so correct operation of the ports is assured.

3.3.2.2 Audio A and B Connectors, DB-9F

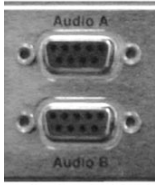

The 9-pin 'D' Type female (DB-9F) Audio A and B connectors are used for the two 32 kbps ADPCM audio inputs and outputs (600Ω transformer coupled, balanced signals). These can be used for both ESC voice circuits in IDR mode, or as the primary data (**FAST** option).

Audio A and B Connectors (DB-9F)		
Pin #	Signal Function	Direction
1	Tx Audio 1 (+)	Out
6	Tx Audio 1 (-)	Out
2	Rx Audio 1 (+)	In
7	Rx Audio 1 (-)	In
8	Tx Audio 2 (+)	Out
4	Tx Audio 2 (-)	Out
9	Rx Audio 2 (+)	In
5	Rx Audio 2 (-)	In
3	Common	

3.3.2.3 Overhead Data A and B Connectors, DB-25M

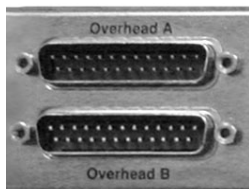

The 25-pin 'D' Type male (DB-25M) Overhead Data A and B connectors are used for passing components of Intelsat specified overhead frame structures. These include 64 kbps EIA-422 and 1/16 IBS overhead ESC at EIA-232. The IDR backward alarm inputs are found on this connector.

Overhead Data A and B Connectors (DB-25M)			
Pin #	Signal Function	Signal Name	Direction
14	IDR 64 kbps ESC TX Data +	TX-422DAT-B	Out
2	IDR 64 kbps ESC TX Data -	TX-422DAT-A	Out
12	IDR 64 kHz ESC TX Clock +	TX-422CLK-B	In
15	IDR 64 kHz ESC TX Clock -	TX-422CLK-A	In
11	IDR 1 kHz TX Octet Clock +	TX-OCT-B	In
24	IDR 1 kHz TX Octet Clock -	TX-OCT-A	In
16	IDR 64 kbps ESC RX Data +	RX-422DAT-B	In
3	IDR 64 kbps ESC RX Data -	RX-422DAT-A	In
9	IDR 64 kHz ESC RX Clock +	RX-422CLK-B	In
17	IDR 64 kHz ESC RX Clock -	RX-422CLK-A	In
19	IDR 1 kHz RX Octet Clock +	RX-OCT-B	In
4	IDR 1 kHz RX Octet Clock -	RX-OCT-A	In
20	Balanced Ext. Ref. Clock +	EXT-CLK-B	Out
23	Balanced Ext. Ref. Clock -	EXT-CLK-A	Out
13	IBS ESC RS232 TX Data	TX-232-DATA	Out
22	IBS ESC RS232 TX Clock	TX-232-CLK	In
8	IBS ESC RS232 RX Data	RX-232-DATA	In
10	IBS ESC RS232 RX Clock	RX-232-CLK	In
5	IBS TX High-Rate ESC Data	TX-ASYNC	Out
6	IBS RX High-Rate ESC Data	RX-ASYNC	In
1	IDR Back Alarm 1 H/W input	BW-IN1	Out
18	IDR Back Alarm 2 H/W input	BW-IN2	Out
21	IDR Back Alarm 3 H/W input	BW-IN3	Out
25	IDR Back Alarm 4 H/W input	BW-IN4	Out
7	Signal Ground	Ground	--

3.3.2.4 Data Interface A and B Connectors, DB-25F



The 25-pin ‘D’ Type female (DB-25F) Data Interface A and B connectors conduct data input and output signals to and from the modem, and connects to customer’s terrestrial equipment.. It conforms to the EIA-530 pinout, which allows for connection of different electrical standards, including EIA-422, V.35, and EIA-232. A shielded 25-pin ‘D’ type connection provides a very solid solution to EMC problems, unlike the sometimes-used V.35 Winchester connector.



It is the user’s responsibility to provide the appropriate cables to connect to this EIA-530 connector.

Data Interface A and B Connectors (DB-25F)						
Pin #	Signal Description	Direction	EIA-422 EIA-530 LVDS	V.35	EIA-232	Circuit #
2	Transmit Data A	Switch to Modem	SD A	SD A	BA	103
14	Transmit Data B	Switch to Modem	SD B	SD B	-	103
24	Transmit Clock A	Switch to Modem	TT A	SCTE A	DA	113
11	Transmit Clock B	Switch to Modem	TT B	SCTE B	-	113
15	Internal Transmit Clock A	Modem to Switch	ST A	SCT A	DB	114
12	Internal Transmit Clock B	Modem to Switch	ST B	SCT B	-	114
3	Receive Data A	Modem to Switch	RD A	RD A	BB	104
16	Receive Data B	Modem to Switch	RD B	RD B	-	104
17	Receive Clock A	Modem to Switch	RT A	SCR A	DD	115
9	Receive Clock B	Modem to Switch	RT B	SCR B	-	115
8	Receiver Ready A	Modem to Switch	RR A	RLSD *	CF	109
10	Receiver Ready B	Modem to Switch	RR B	-	-	109
23	External Carrier Off (EIA-232 ‘1’ or TTL ‘low’)	Switch to Modem	-	-	-	-
18	Fused +12 volts	Modem to Switch	-	-	-	-
25	Fused -12 volts	Modem to Switch	-	-	-	-
21	Bal/Unbal interface	Modem to Switch	-	-	-	-
20	1:1 Switch present	Switch to Modem	-	-	-	-
6	Unit fault	Modem to Switch	-	-	-	-
13	Tx Traffic fault	Modem to Switch	-	-	-	-
5	Rx Traffic fault	Modem to Switch	-	-	-	-
7	Signal Ground	-	SG	SG	AB	102
1	Shield	-	Shield	FG	AN	101

3.3.3 Rear Panel Utility Connectors

3.3.3.1 IDR Alarms A and B Connectors, DB-15F

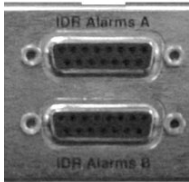

The 15-pin Type 'D' female (DB-15F) IDR Alarms A and B interface connectors provide four Form-C backward alarm outputs specified by Intelsat.

IDR Alarms A and B Connectors (DB-15F)		
Pin #	Signal Function	Name
2	Backward Alarm 1 is active	BA-1-NO
9		BA-1-COM
1		BA-1-NC
10	TBD	MON-A
4	Backward Alarm 2 is active	BA-2-NO
11		BA-2-COM
3		BA-2-NC
6	Backward Alarm 3 is active	BA-3-NO
13		BA-3-COM
5		BA-3-NC
14	TBD	MON-B
8	Backward Alarm 4 is active	BA-4-NO
15		BA-4-COM
7		BA-4-NC
12	Ground	GND

3.3.3.2 Aux Serial A and B Receptacles, USB Type 'A'



Although these ports use USB connectors, the signals are not *USB-compatible*. DO NOT connect either of these ports to the USB port of a PC or other computing device.

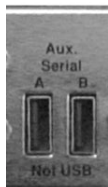

The USB Type 'A' Aux Serial A and B receptacles are additional EIA-232 serial ports, connected to the modem's USB Type 'B' Aux Serial ports when part of a 1:1 redundant pair.

Aux Serial Receptacles A and B (USB Type 'A')		
Pin #	Description	Direction
1	Ground	--
2	EIA-232 TX Data	Out
3	EIA-232 RX Data	In
4	Ground	--

3.3.3.3 Ext Ref A and B Connectors, 50Ω BNC

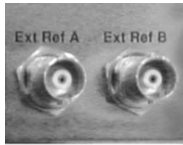

The Ext Ref A and Ext Ref B connectors are 50Ω BNC female connectors used to permit the connection of an external reference input signal.

3.3.4 Ground Connection

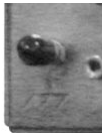

A #10-32 stud is used for connecting a common chassis ground among equipment.

3.4 Data Interface Converter Modules / Adapters

For operation at the maximum data rate of 20 Mbps, the CDM-600 uses a serial LVDS interface. However, many applications, including high-speed routers, use the popular HSSI interface (using negative ECL levels). For these applications, the Comtech EF Data CIC-20 LVDS to HSSI Interface Converter module is available.



Also available, for conversion of LVDS to ASI, is the Comtech EF Data CIC-35 LVDS to ASI Interface Converter module.



Either module typically connects directly to the rear of a standalone CDM-600. For CDM-600s used in redundancy with a CRS-150, however, either module plugs into the Overhead / Data Interface connector set on the front panel of the CRS-150.

For conversion of the Balanced G.703 connection from a DB-15M connector to an RJ-48 modular jack, the optional CA-0000268 Adapter may be plugged into the Balanced G.703 connector on the front panel of the CRS-150.



3.4.1 CIC-20 HSSI Connector, HD-50F



The 50-pin type Mini-D/SCSI2 female HSSI connector on the optional CIC-20 LVDS to HSSI Interface Module provides HSSI data transmission as converted for use from the User Data (LVDS) interface.

Note: For the CIC-20's Overhead user-side connector pinout table, see **Sect. 3.2.2.1** in this chapter. For further details about the CIC-20, refer to that product's user manual.

Observe the following:

Signal Function	HSSI Signal	EIA-613 Circuit	Pin # (+, -)	Circuit Direction
Signal Ground	SG	102	1, 26	
Receive Timing	RT	115	2, 27	From DCE
DCE Available	CA	107	3, 28	From DCE
Receive Data	RD	104	4, 29	From DCE
Loopback Circuit C	LC	undefined	5, 30	Not used
Send Timing	ST	114	6, 31	From DCE
Signal Ground	SG	102	7, 32	
DTE Available	TA	108/2	8, 33	To DCE
Terminal Timing	TT	113	9, 34	To DCE
Loopback Circuit A	LA	143	10, 35	Not used
Send Data	SD	103	11, 36	To DCE
Loopback Circuit B	LB	144	12, 37	Not used
Signal Ground	SG	102	13, 38	
Reserved (to DCE)			14, 15, 17, 18, 39 - 43	Not used
Reserved (to DTE)			16, 20-23, 45-48	Not used
Test Mode	TM	142	24, 49	Not used
Signal Ground	SG	102	25, 50	

3.4.2 CIC-35 ASI Connectors, 75Ω BNC



The ASI In and Out connectors on the optional CIC-35 LVDS to ASI Interface Module are 75Ω BNC female connectors for user receive and transmit of ASI data as converted for use from the User Data (LVDS) interface.

Note: For the CIC-35's Overhead user-side connector pinout table, see **Sect. 3.2.2.1** in this chapter. For further details about the CIC-35, refer to that product's user manual.

3.4.3 E1/T1 RJ-48 Connection via Balanced G.703 Interface Connector

For E1/T1 operation via an RJ-48 user interface, the optional CN-0000268 Adapter, shown in **Figure 3-2**, may be purchased from Comtech EF Data to adapt the Balanced E1/T1 G.703 DB-15F connector on the front panel of the CRS-150 to an RJ-48 female connection.

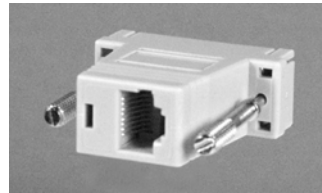

User Interface Side (RJ-48 F)

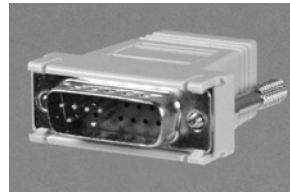

Switch Interface Side (DB-15M)

CN-0000268 Adapter Pin Assignments		
Pin #		Signal Name
RJ-48 (User Side)	DB-15M (Modem Side)	
1	9	Tx+
2	1	Tx-
3	2	GND
4	11	Rx+
5	3	Rx-
6	4	GND

Note: Pins 7 and 8 on the RJ-48 side, and pins 5-8, 10, and 12-15 on the DB-15 side, are not used.

Figure 3-2. CN-0000268 DB-15M → RJ-48F Adapter for E1/T1 Operation

Chapter 4. CABLES AND CONNECTIONS

4.1 Overview

When assembling a Comtech EF Data 1:1 Redundancy System, in addition to purchasing the desired modem pair (one Redundant modem, one Traffic modem) and the CRS-150 1:1 Redundancy Switch, the user is also required to purchase all cables and components required for interconnection of the redundant configuration to various interfaces (i.e., control, IF, and data).

The sections that follow in this chapter provide specific interface examples that identify the individual redundancy kit item(s) required to assemble that interface.



- 1. It is physically impossible to connect all available data interface solutions within a single 1:1 redundancy system at a given time. For example, when using the CDM-600 in a 1:1 system, the user is unable to establish an EIA-422/232 interface together with an HSSI interface. Therefore, the quantities of cables and accessories furnished with each redundancy kit have been predetermined with this operational limitation taken into consideration.***
- 2. It is essential to ensure that the data and IF connections, both Rx and Tx, are made correctly. For example, the Transmit IF from Unit 'A' connects to the Tx IF port 'A' on the CRS-150, and Unit 'B' to 'B', and the same for the Rx IF connections. Failure to observe this requirement will result in the system malfunctioning.***

4.2 Cabling to the CDM-600

Examples for connecting a pair of CDM-600 modems together with the CRS-150 are provided in this section. Once all connections have been made, refer to **Chapter 5. MODEM AND SWITCH CONFIGURATION** in this manual – as well as the **CDM-600 Satellite Modem Installation and Operation Manual** – to enable 1:1 operation.

The following cables, purchased separately unless noted otherwise, are utilized with all possible CDM-600 data interface configurations:

CRS-150 → CDM-600 1:1 Redundancy – Interface Cabling Reference			
CEFD Part #	Description	Used for:	Ch. 4 Fig.
CA/USB-AM/BM-3	Control Cable, USB Type 'B' to USB Type 'A' (3') **	Modem → Switch Control	4-1
CA/WR9040-4	Data Cable, DB-25F → DB-25F (4')	Modem → Switch Overhead	4-12
CA/WR9378-4	Data Cable, DB-9M → DB-9M (4')	Modem → Switch Audio	4-13
CA/WR9563-4	Data Cable, DB-15M → DB-15M (4')	Modem → Switch G.703	4-8, 4-9, 4-10, 4-11
CA/WR9564-4	Data Cable, DB-15M → DB-15M (4')	Modem → Switch IDR Alarms	4-3
PL/0813-4	Coax Cable, Type 'BNC' 75Ω (4')	Modem → Switch Ext Ref	4-4
PL/0946-1	IF (Tx/Rx) Coax Cable, Type 'BNC' 50Ω (4')	Modem → Switch IF Interface	4-2
PL/6233	Data/Control Cable, Universal, DB-25M → DB-25M (4')	Modem → Switch Universal Data	4-6, 4-7



When connecting the Control cable between the CRS-150 and the modems, ensure that screw locks on the 'D' type connectors are securely fastened. This will prevent the accidental unmating of the cable, particularly when a standby unit is being removed or replaced.



**** Although the Auxiliary Serial ports on the CRS-150 and CDM-600 use USB connectors, the signals are not USB compatible. DO NOT use these cables to connect any of these ports to the USB port of a PC or other computing device.**

To properly connect a CDM-600 modem pair together with the CRS-150 1:1 Redundancy Switch, it is essential to ensure that all cable connections, particularly the control and IF (both Rx and Tx) connections, are made correctly:

<i>For</i>	<i>Refer to:</i>
Modem → Switch Control Connections	Sect. 4.2.2
Modem → Switch IF Connections	Sect. 4.2.3
Modem → Switch Utility Connections	Sect. 4.2.4
Modem → Switch Data Interface Connections	Sect. 4.2.5

4.2.1.1 CRS-150 Accessories

Additional accessory equipment that may be ordered includes:

- CIC-20 (CEFD P/N PL/9459-1) HSSI to LVDS Interface Converter
- CIC-35 (CEFD P/N PL/10335-1) ASI to LVDS Interface Converter
- CEFD P/N PS/AC18W01P01 Auxiliary Power Supply for use with CIC-20 or CIC-35
- CEFD P/N CA-0000268 DB-15F to RJ-48 Adapter (for Balanced G.703 E1/T1)

4.2.2 Modem-to-Switch Control Interface Connection

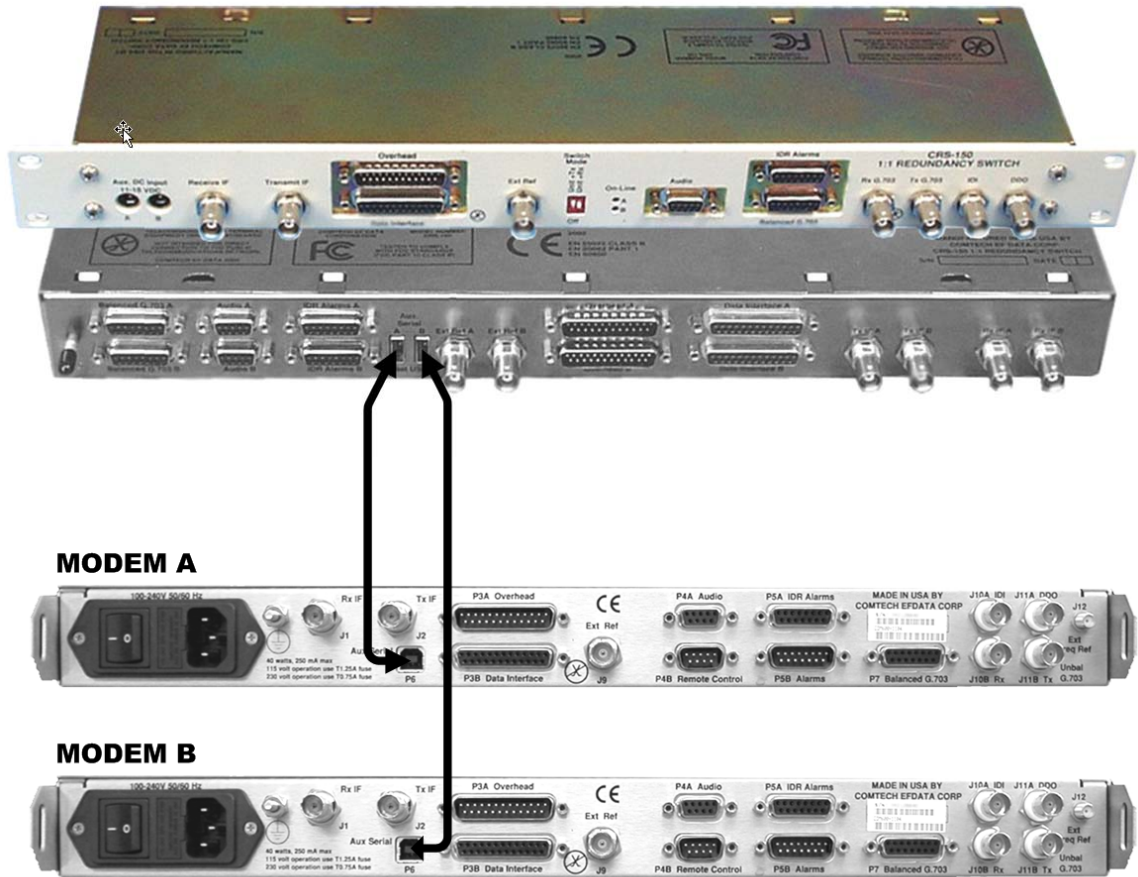

QTY	Part No.	Description
2	CA/USB-AM/BM-3	Auxiliary Serial Cable, USB Type 'B' to USB Type 'A' (3')



Although these ports use USB connectors, the signals are not USB compatible. DO NOT use these cables to connect any of these ports to the USB port of a PC or other computing device.

Figure 4-1. Modem-to-Switch Control Connection

4.2.3 Modem-to-Switch IF Interface Connection

EXAMPLE: The Tx IF from 'Modem A' connects to the 'Tx IF A' port on the CRS-150; similarly, the Tx IF from 'Modem B' connects to the 'Tx IF B' port on the CRS-150.

The same logic applies for the Rx IF connections. It is important to note that failure to observe this requirement will result in system malfunction.

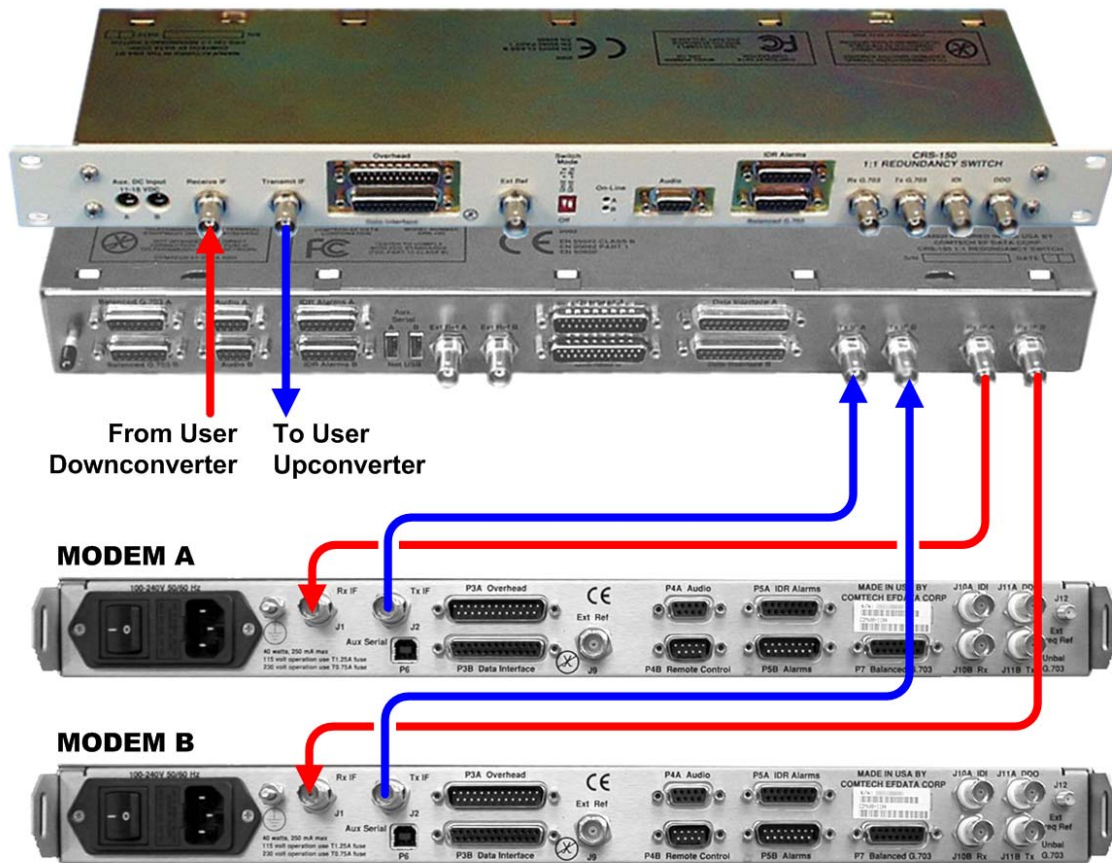

QTY	Part No.	Description
4	PL/0946-1	RoHS-Compliant Cable – IF (Tx/Rx), 50Ω Type 'BNC' (4')

Figure 4-2. Modem-to-Switch IF Connection

4.2.4 Modem-to-User Utility Interface Connection and Examples

4.2.4.1 IDR Alarms Data Interface Example

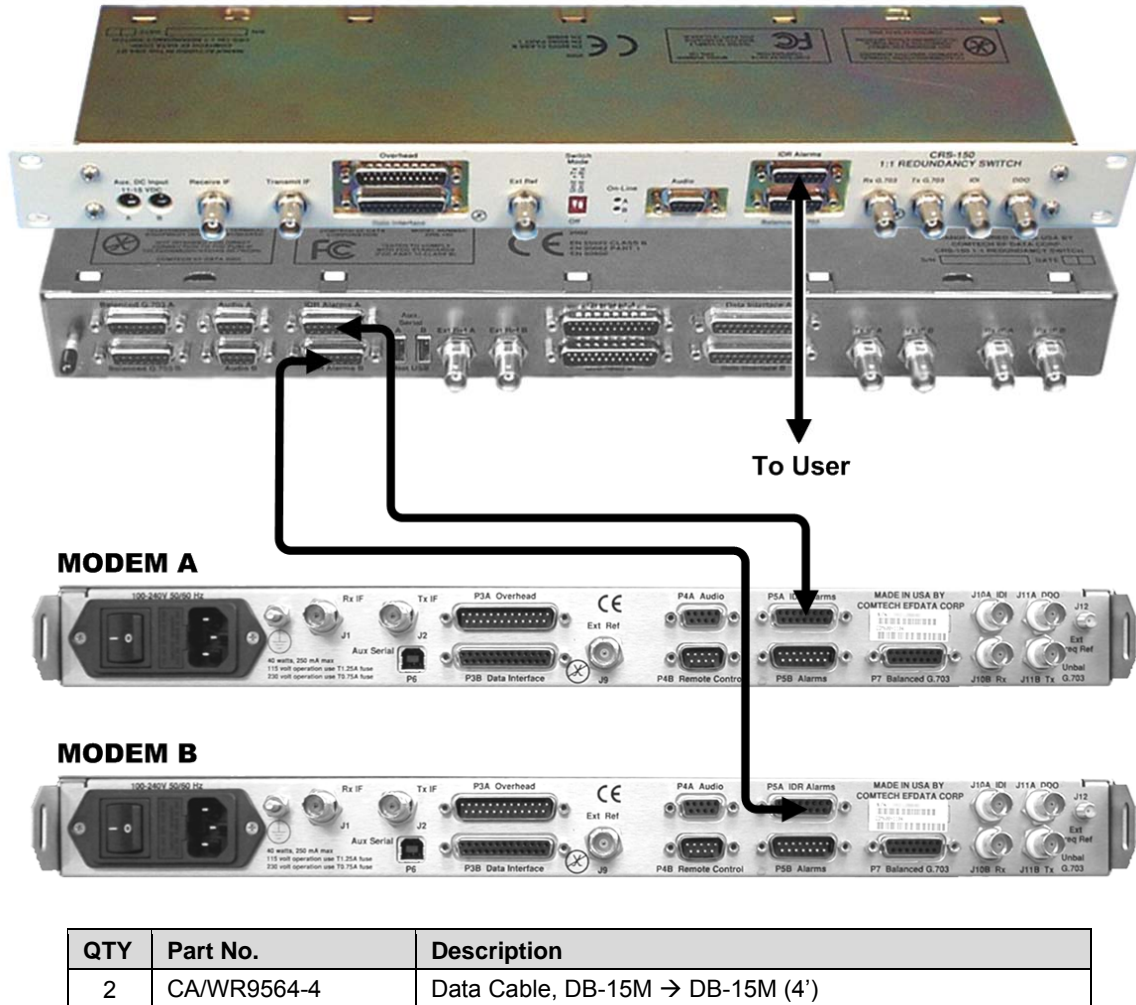
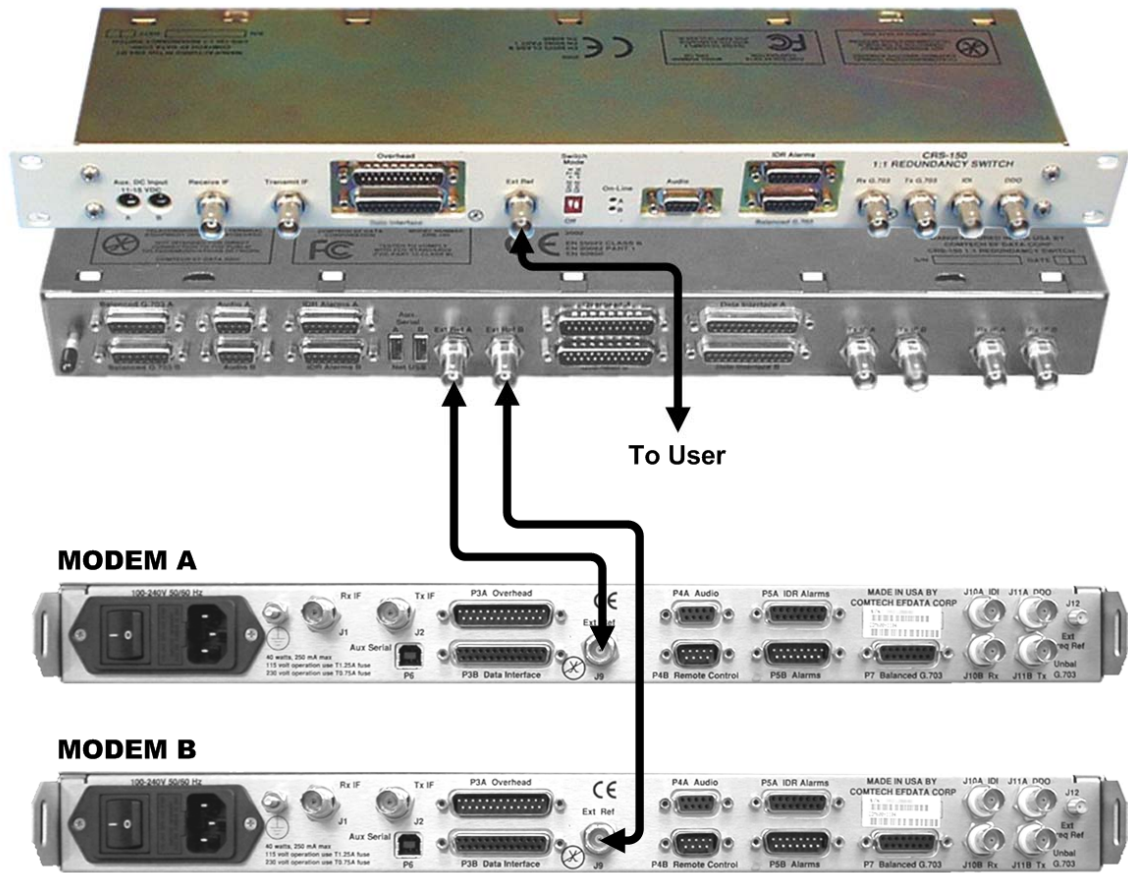

Figure 4-3. IDR Alarms Interface Example

4.2.4.2 External Reference Data Interface Example



QTY	Part No.	Description
2	PL/0813-4	Coax Cable, 75Ω Type 'BNC' (4')

Figure 4-4. Ext Ref (External Reference) Interface Example

4.2.5 Modem-to-User Data Interface Connection and Examples

Aside from control, IF, and utility switch-to-modem cabling shown previously, there are a number of data interface configurations available with the CDM-600. The block diagram shown in **Figure 4-5** is typical for the examples shown in **Sects. 4.2.5.1** through **4.2.5.9**.

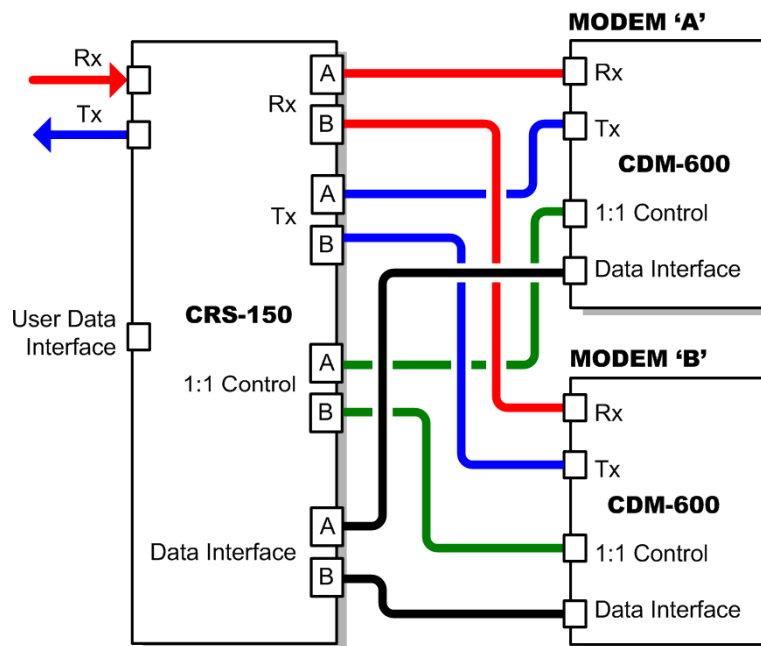

Note: "Data Interface" denotes a generic connection. See examples provided in this chapter for a specific data interface configuration (i.e., G.703, Overhead, etc.)

Figure 4-5. CDM-600 Block Diagram: User → Modem → Switch → Traffic

Note: Unless otherwise specified, the interface cables and components identified in each of the following examples are individually available for purchase (See **Sect. 4.2**). For each user interface, one cable/component set per 1:1 modem pair is required (see examples for specified quantities).

4.2.5.1 RS-422/232 Interface Example

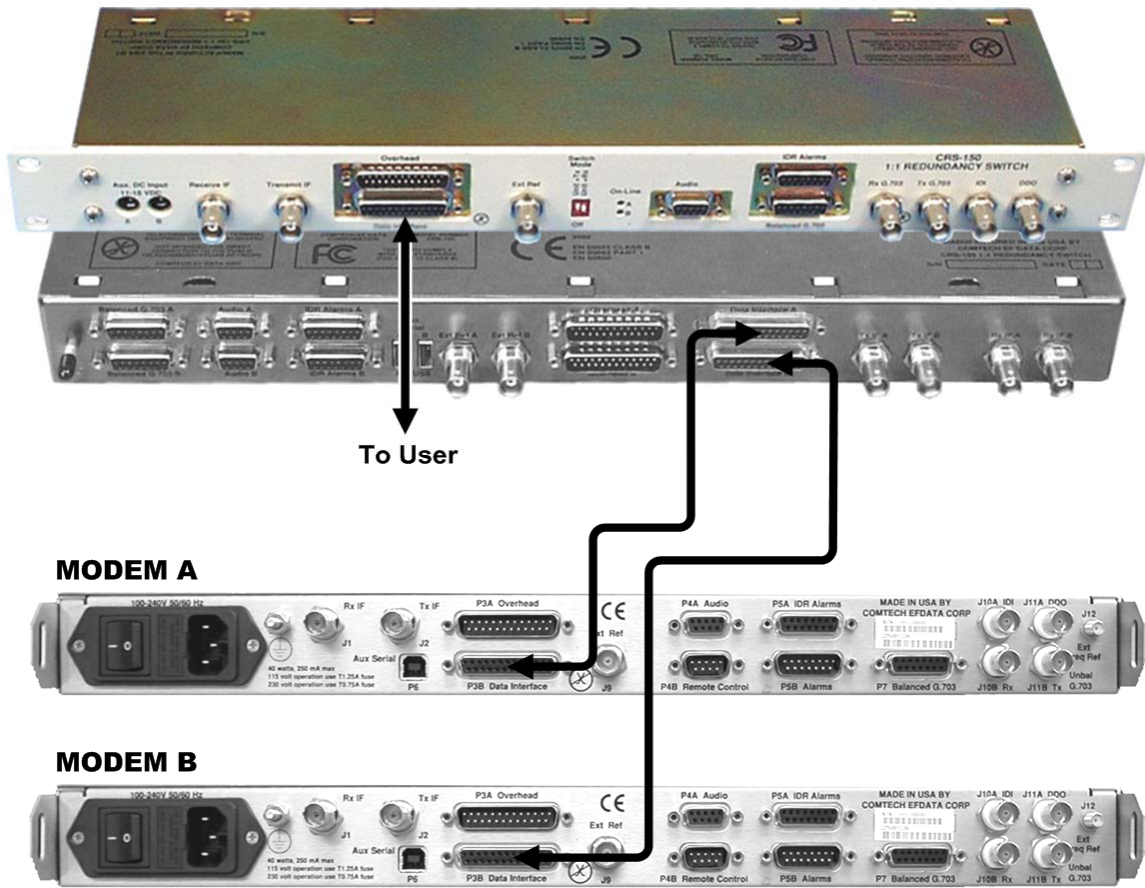

QTY	Part No.	Description
2	PL/6233	Data/Control Cable, Universal, DB-25M → DB-25M (4')

Figure 4-6. RS-422/232 Interface Example

4.2.5.2 HSSI Data Interface Example

Figure 4-7 shows the cabling example of a CDM-600 HSSI 1:1 modem configuration using the optional CIC-20 HSSI/LVDS Interface Converter. This module converts the DB-25F Data Interface connector on the front panel of the CRS-150 into a HD-50F connector used for the HSSI data interface. The module's DB-25F connector interface facilitates data pass-through for the DB-25M Overhead data user connection.

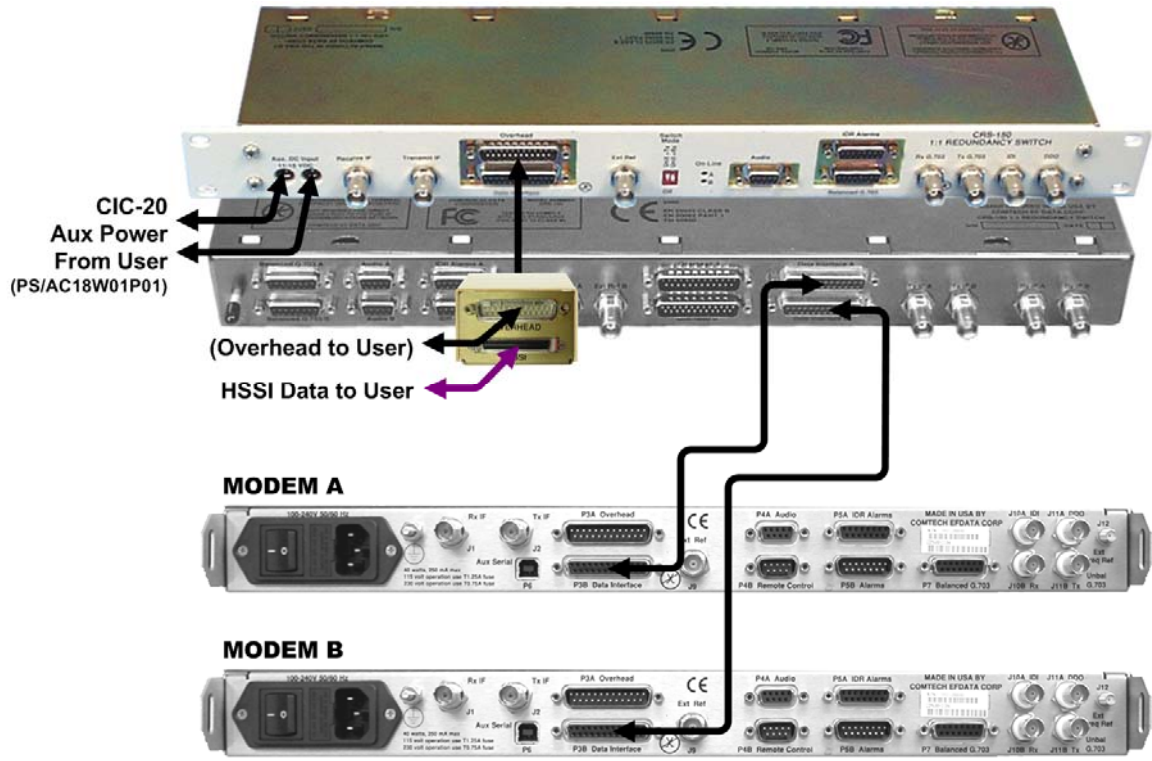

QTY	Part No.	Description
2	PL/6233	Data/Control Cable, Universal, DB-25M → DB-25M (4')
1	PL/9459-1	CIC-20 HSSI to LVDS Interface Converter
2	PS/AC18W01P01	Auxiliary Power Supply for CIC-20

Figure 4-7. HSSI Example

4.2.5.3 G.703 Balanced Interface Example

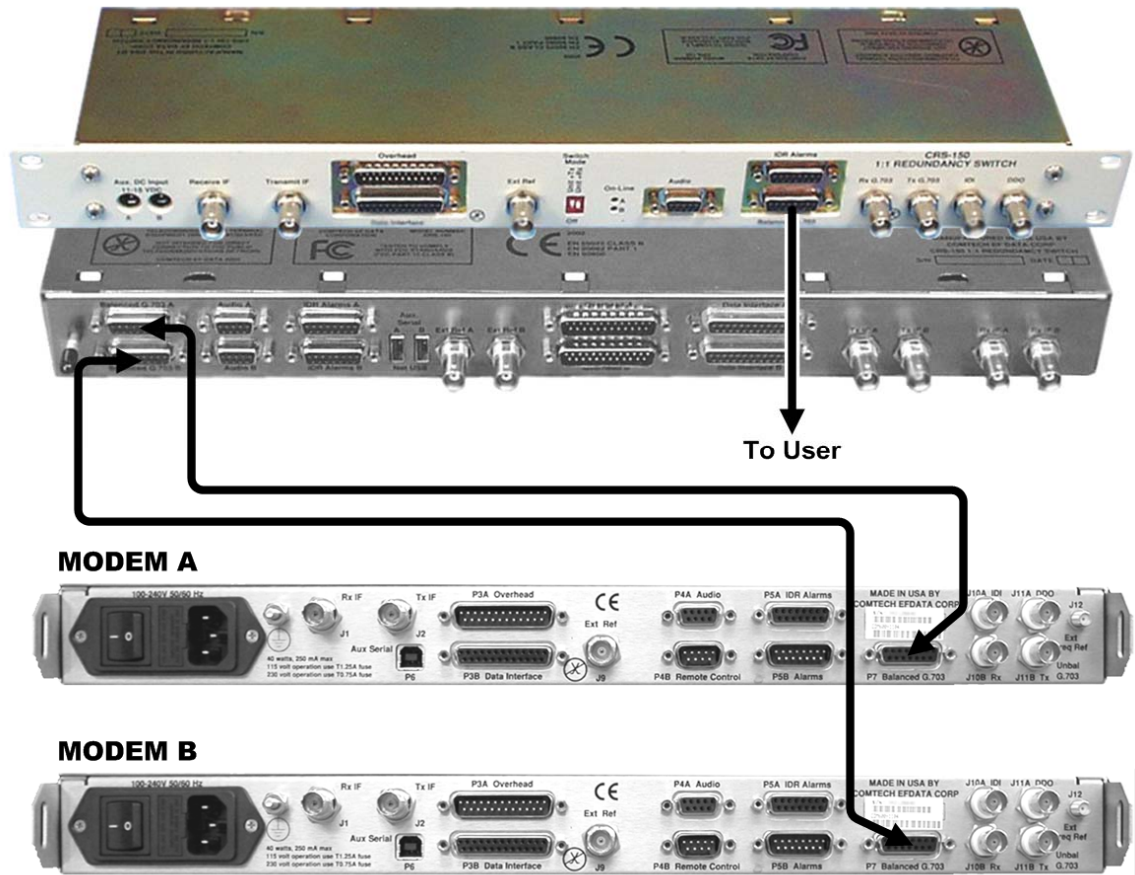

QTY	Part No.	Description
2	CA/WR9563-4	Data Cable, DB-15M → DB-15M (4')

Figure 4-8. G.703 Balanced Interface Example

4.2.5.4 G.703 Unbalanced Interface Example

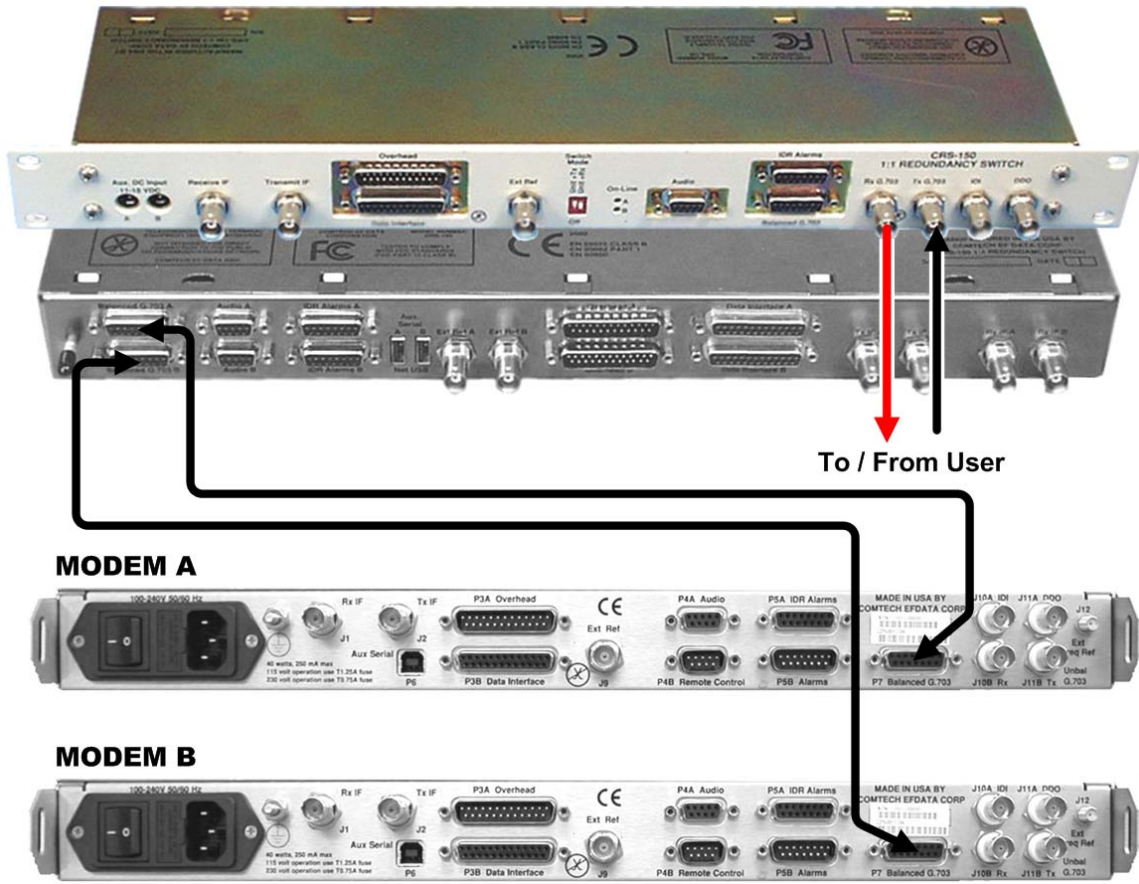

QTY	Part No.	Description
2	CA/WR9563-4	Data Cable, DB-15M → DB-15M (4')

Figure 4-9. G.703 Unbalanced Interface Example

4.2.5.5 ASI Data Interface Example

Figure 4-10 shows the cabling example of a CDM-600 HSSI 1:1 modem configuration using the optional CIC-35 DVB-ASI/LVDS Interface Converter. This module converts the DB-25F Data Interface connector on the CRS-150 front panel into the BNC connector pair used for the ASI data interface. The module's DB-25F connector interface facilitates data pass-through for the DB-25M Overhead data user connection.

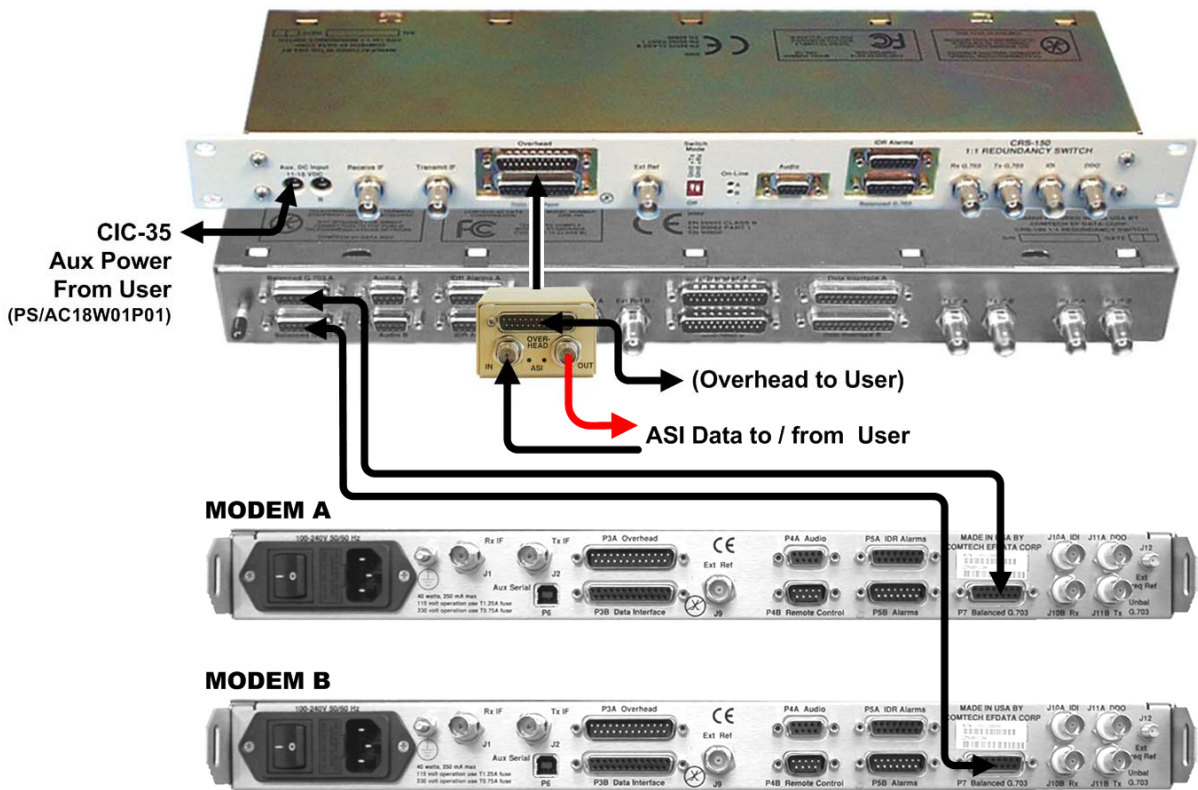

QTY	Part No.	Description
2	CA/WR9563-4	Data Cable, DB-15M → DB-15M (4')
1	PL/10335-1	CIC-35 ASI to LVDS Interface Converter
1	PS/AC18W01P01	Auxiliary Power Supply for CIC-35

Figure 4-10. ASI Example

4.2.5.6 E1/T1 Data Interface Example

For E1/T1 operation via an RJ-48 user interface, the optional CN-0000268 Adapter, shown in **Figure 4-11**, may be purchased from Comtech EF Data to adapt the DB-15F Balanced G.703 connector on the front panel of the CRS-150 to an RJ-48 female connection.

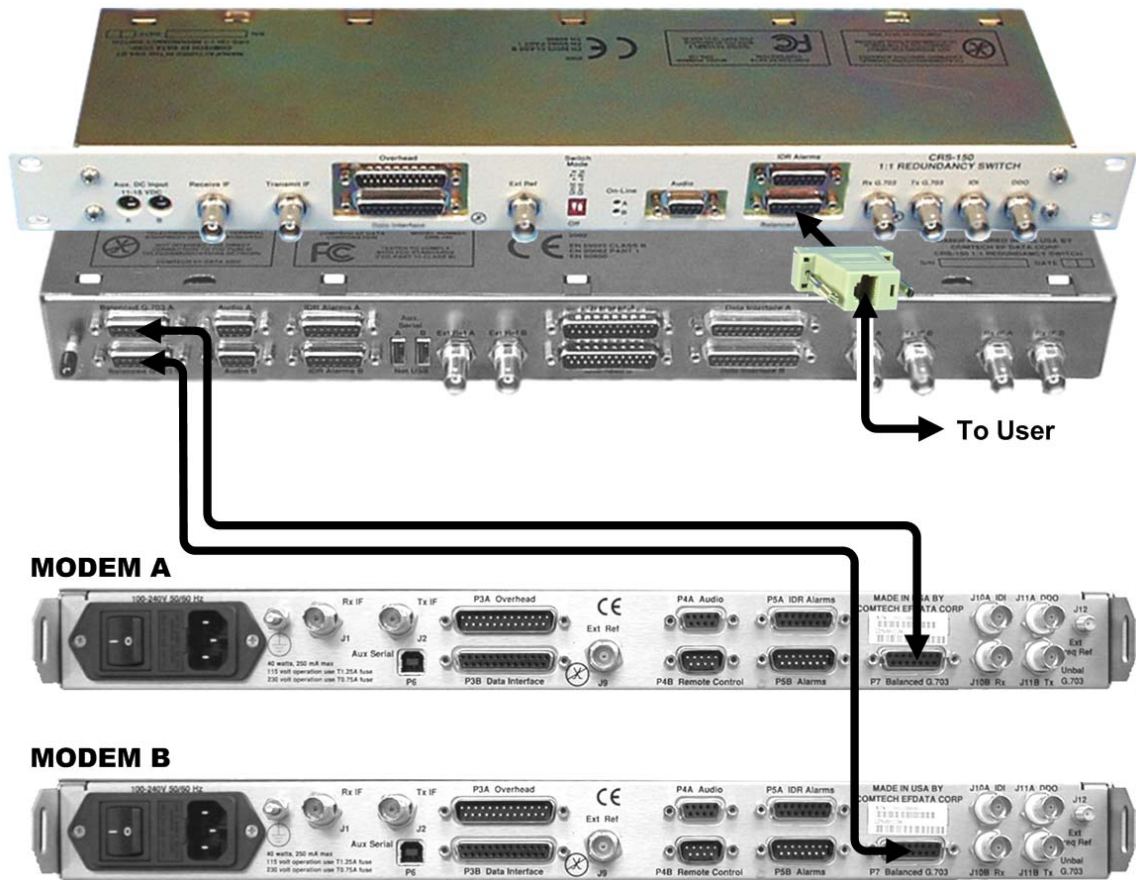

QTY	Part No.	Description
2	CA/WR9563-4	Data Cable, DB-15M → DB-15M (4')
1	CA-0000268	Adapter, DB-15M → RJ-48F

Figure 4-11. G.703 E1/T1 Interface Example

4.2.5.7 Overhead Data Interface Example

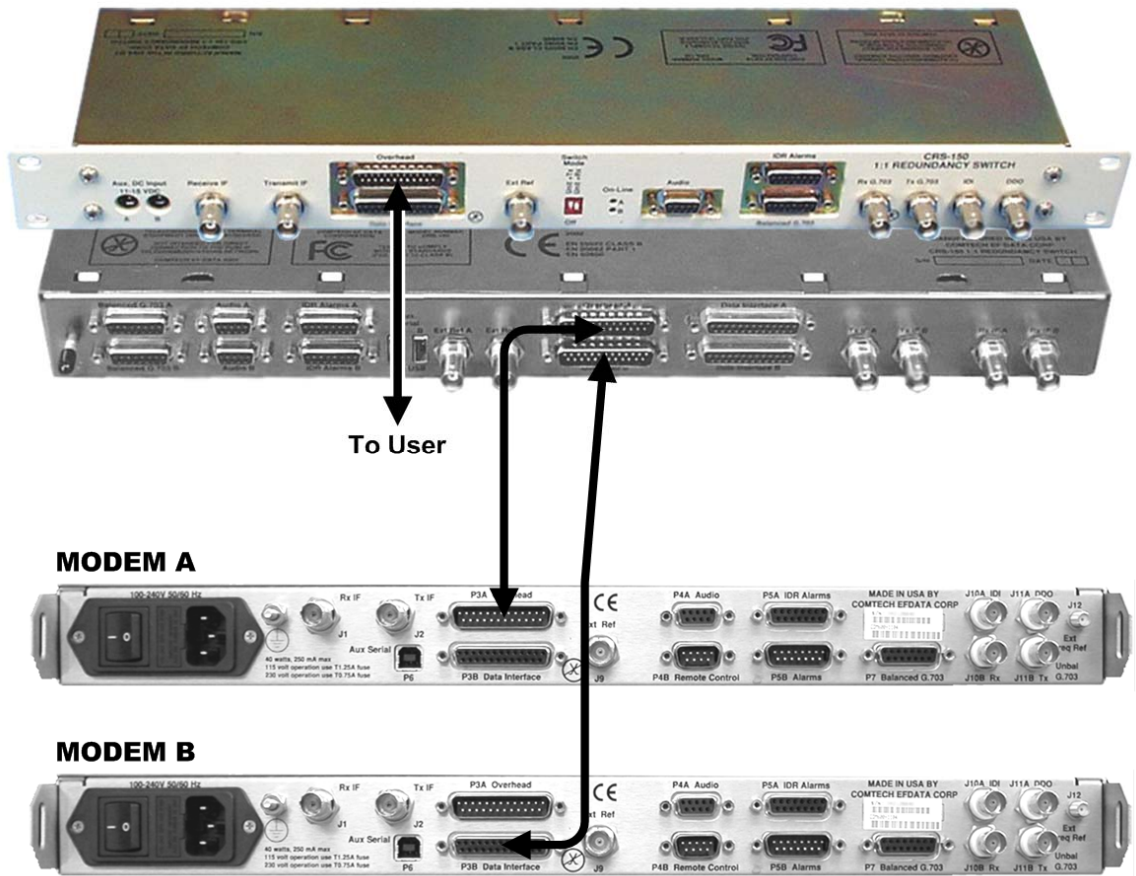

QTY	Part No.	Description
2	CA/WR9040-4	Data Cable, DB-25M → DB-25M (4')

Figure 4-12. Overhead Interface Example

4.2.5.8 Audio Data Interface Example

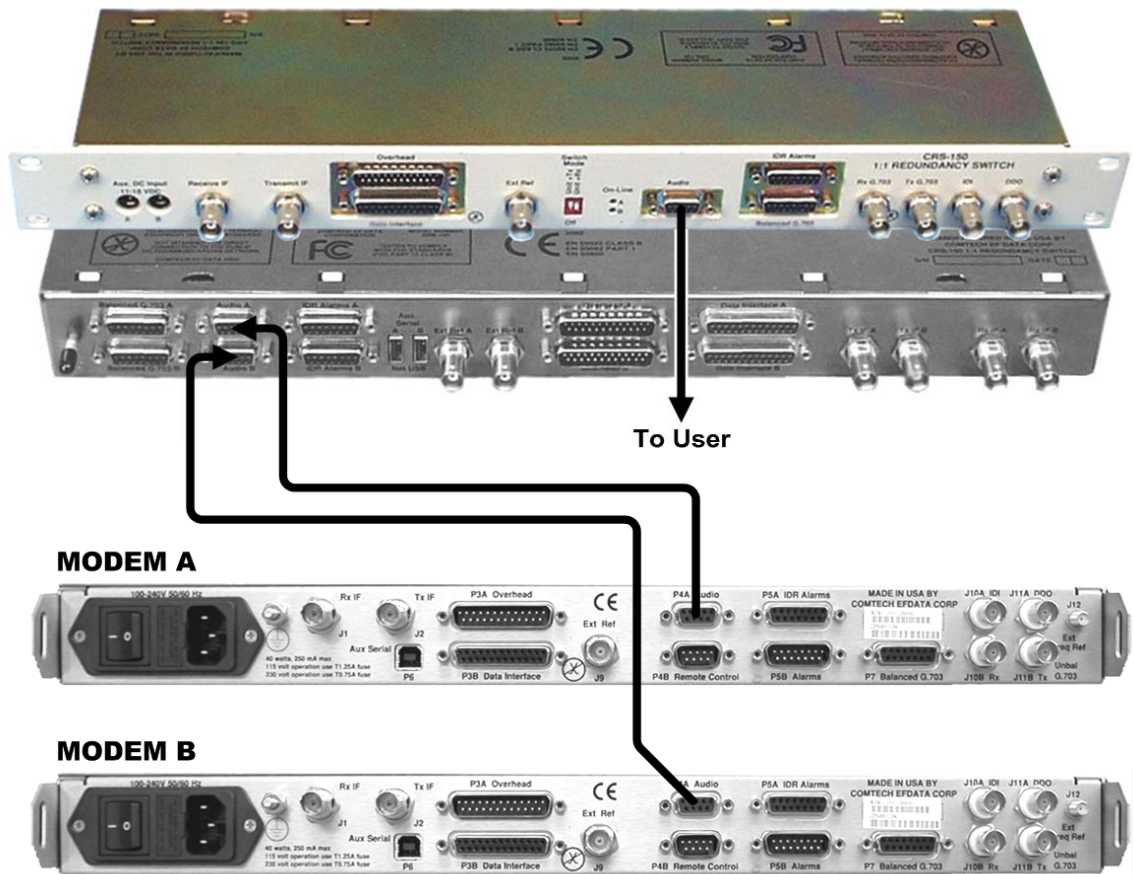

QTY	Part No.	Description
2	CA/WR9378-4	Data Cable, DB-9M → DB-9M (4')

Figure 4-13. Audio Interface Example

4.3 Cabling to the CDM-600L (CLM-9600L)

The block diagram shown in **Figure 4-14** depicts connection of a pair of CDM-600L (CLM-9600L) modems together with the CRS-150 and CRS-170A switches.

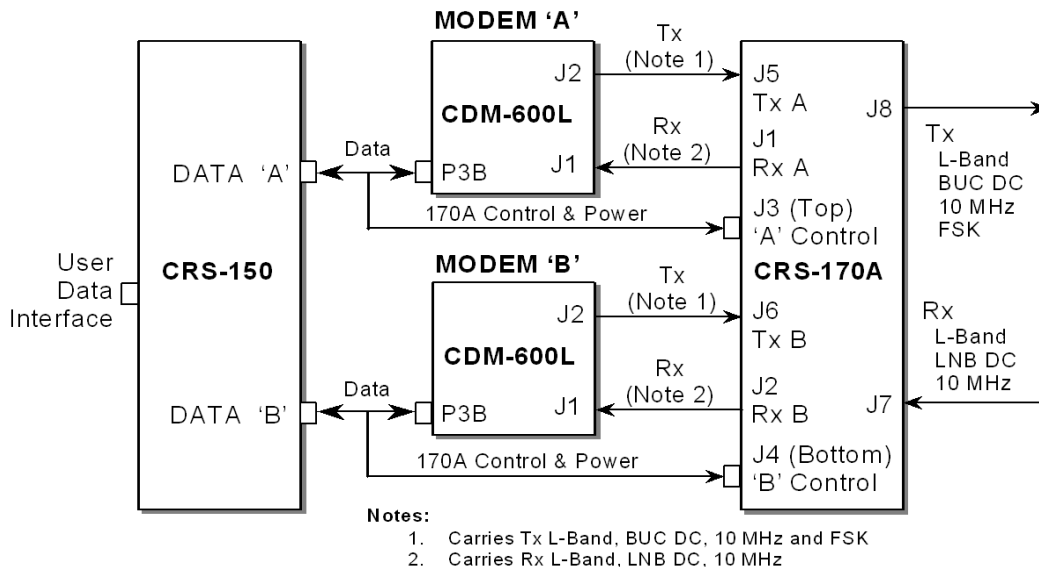

Figure 4-14. CDM-600L (CLM-9600L) Block Diagram: Cable Connections

The following table lists cable assemblies that may be supplied with the CRS-170A when used with the CDM-600L (CLM-9600L) and CRS-150. Other cables between the CRS-150 and the CDM-600L (CLM-9600L) modems are supplied with the CRS-150.

QTY	Part No.	Description
2	CA/WR10456-4	Cable – 1:1 Y-Splitter, Data/Control, DB-25M → DB-25M, 4' / DB-9M, 1'
4	CA/RF10453-4	RoHS-Compliant Cable – IF (Tx/Rx), 50Ω Type 'N', 4'



When connecting the Control cable between the CRS-150 and the modems, ensure that screw locks on the 'D' type connectors are securely fastened. This will prevent the accidental un-mating of the cable, particularly when a standby unit is being removed or replaced.

Chapter 5. MODEM AND SWITCH CONFIGURATION

5.1 Overview



In order to avoid damage to the modems and CRS-150 switch, it is important for the user to follow this sequence of configuration:

- First, **connect cables between the (powered OFF) modems and switch as outlined previously in Chapter 4. CABLES AND CONNECTIONS.**
- Second, **configure the modems for 1:1 redundant operation, as outlined in this chapter in Sect. 5.2.**
- Third, **once the modems have been properly configured for 1:1 redundant operations, the user should then set the DIP switches on the CRS-150 to the correct modem selection, as outlined in this chapter in Sect. 5.3 CRS-150 Switch DIP Settings.**

5.2 Configuration of CDM-600s for 1:1 Redundancy



For correct operation of the CRS-150, the CDM-600 modems must have the following installed:

- **Firmware Version 1.1.0 (or higher)**
- **Hardware Revision 3**

If the modem does not meet this requirement, contact Comtech EF Data. Flash firmware upgrades are free and may be downloaded from the CEFD Web page. Hardware revision upgrades must be performed at CEFD.

The User can fully configure, monitor, and control the operation of the CDM-600 from the modem front panel (**Figure 5-1**) using the keypad and display, where nested menus displaying all available options are used and prompt the User to carry out a required action.

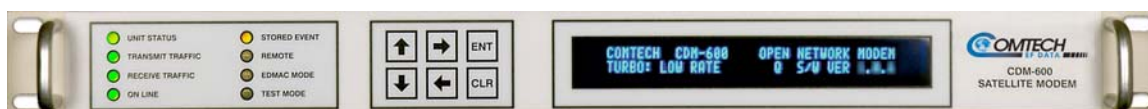

Figure 5-1. CDM-600 Front Panel

For detailed information on using the CDM-600 front panel features, refer to the **CDM-600/600L Satellite Modem Installation and Operation Manual**.

There are two modes of redundant operation: *automatic* and *manual*.

5.2.1 Automatic Redundant Operation

The procedure to configure each CDM-600 modem for automatic 1:1 redundancy is as follows:

1. As noted previously, ensure that all cables – i.e., control, IF, utility, and data – have been properly connected between the modems and the CRS-150 as directed in **Chapter 4. CABLES AND CONNECTIONS**.
2. The CDM-600 needs no unique or special settings for operation in a 1:1 redundancy configuration. However, before proceeding, check that the Auxiliary Serial link between the two units is functioning correctly:

From the online unit's front panel, (**Select:**) **INFO** → **MISC**, using the [**←**][**→**] arrow keys then press [**ENT**]. The bottom line of the display should indicate that the 1:1 link is active:

```
MISCELLANEOUS:  NORMAL
1:1 SWITCH = NOT CONNECTED    ONLINE
```

This screen shows the following:

- **Top line:** Operational Mode (**TEST MODE** or **NORMAL**)
- **Bottom line:** 1:1 Link Status (**CONNECTED** or **NOT CONNECTED**), and Redundancy Status (**OFFLINE** or **ONLINE**).

If the unit is *not* in 1:1 mode, then recheck that the Auxiliary Serial cables have been correctly installed before proceeding.

3. Once it has been determined that the 1:1 system is operational, the user should set up the conditions, via the “Switch Mode” DIP switches on the front panel of the CRS-150, by which the CRS-150 will initiate an automatic switchover. See **Sect. 5.3** for details.

The system, now configured, is ready to be put into service.

5.2.2 Manual Redundant Operation (Forced Switchover)

There are two ways to force manual switchover in a 1:1 system:

1. Switchover via the Front Panel (from the **(Select:) UTILITY** menu).
2. Switchover via the Remote Bus (ASCII String).

5.2.2.1 Forced Switchover via the CDM-600 Front Panel

Using the CDM-600 front panel keypad, **(Select:) UTILITY → 1:1-MANUAL-SWITCH**, using the [**←**][**→**] arrow keys, then press [**ENT**]:

**PRESS ENTER TO FORCE THIS
UNIT TO STANDBY (1:1 ONLY)**

If the unit is part of a 1:1 redundant pair of modems, and this unit is currently *Online*, pressing [**ENT**] will cause the unit to switch to *Standby*.

Note: This only works from the front panel of the *Online* unit. If this is carried out from the front panel of the *Standby* unit, it will not cause a switchover.

5.2.2.2 Forced Switchover via Remote Bus

Forced Switchover via Remote Bus can be accomplished with the user’s own software, or with Comtech EF Data’s Monitor and Control Software package (SatMac).

Send ASCII string **<XXXX/FSW=<CR>** (where XXXX is the address of the online unit) to the online unit to force a switchover.

5.2.3 Replacement of Standby Unit



If it becomes necessary to remove a Standby unit from the redundancy system, turn the power off before attempting to disconnect any of the cables.

Similarly, when replacing a Standby unit, fully reconnect all cables before applying power.

REMEMBER: In a typical 1:1 modem stack, the top unit is ‘Modem A’; the bottom unit is ‘Modem B’.

5.3 CRS-150 Switch DIP Settings

Two configuration switches are provided on the front panel of the CRS-150 L-Band 1:1 Redundancy Switch (see **Figure 5-2**). These ‘Switch Mode’ DIP switches control the conditions that initiate an automatic switchover.

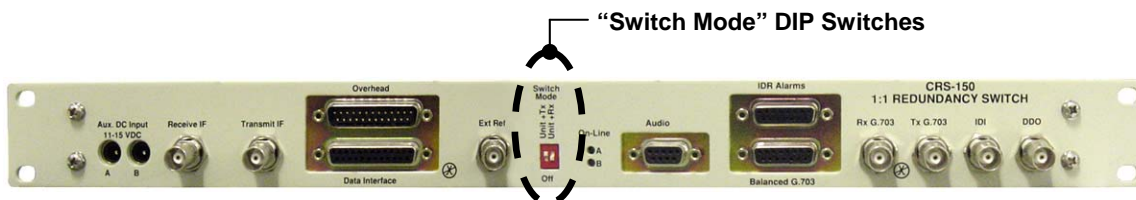

Figure 5-2. CRS-150 Front Panel – DIP Switches

Table 5-1 illustrates the settings for the ‘Switch Mode’ DIP switch settings that determine switchover functionality for a given redundancy configuration.

Table 5-1. CRS-150 DIP Switch Settings

‘Switch Mode’ DIP Settings			
DIP	Left Switch	Right Switch	Result
	Down (Off)	Down	Switchover upon a Unit fault only
	Up	Down	Switchover upon a Unit or Tx Traffic fault
	Down	Up	Switchover upon a Unit or Rx Traffic fault
	Up	Up	Switchover upon a Unit or Tx Traffic or Rx Traffic fault



RECOMMENDATION:

Comtech EF Data recommends that for most applications, the CRS-150 should be configured for Switchover upon a Unit fault only.

Once switchover functionality has been assigned, the modems in redundancy handle faults and alarms based on the combination of the ‘Switch Mode’ DIP settings, and how faults and alarms are handled by the modems, as configured using the (Select:) **INFORMATION: ALARM-MASK** menu via the CDM-600 front panel:

**ALARMS MASKED: TX-AIS RX-AIS BUF-SLIP
AGC EBNO SAT TERR**

This modem screen shows only any alarm(s) designated as currently **masked**; if an alarm is *not* masked, the relevant screen position of that feature is replaced with a blank space. For detailed information on possible fault conditions and alarm masking in general, see **Chapter 5. FRONT PANEL OPERATION** in the **CDM-600/600L Satellite Modem Installation and Operation Manual**.

Appendix A. CABLE DRAWINGS

A.1 Introduction

This appendix contains drawings of cables used with the CRS-150 1:1 Redundancy Switch. These cables are broken into two categories: Control Interface Cables and IF / Utility / Data Interface Cables. Each section provides illustrations of the cables' technical specifications; additionally, the table in each section cross-reference to the illustrations found in **Chapter 4. CABLES AND CONNECTIONS**.

A.2 Control Interface Cables

App. A FIG	REF Ch. 4 FIG	CEFD CABLE P/N	DESCRIPTION	Modem → Switch USED FOR (TYPE)
A-1	4-1	CA/USB-AM/BM-3	USB Type 'B' Male → USB Type 'A' Male, 3'	1:1 Auxiliary Serial Control
A-2	4-14	CA/WR10456-4	Control/Data Cable, Y-Splitter DB-25M → DB-25M (4'), DB-9M (1')	1:1 Data/Control CDM-600L (CDM-9600L) → CRS-150 → CRS-170A

A.2.1 Modem-to-Switch Auxiliary Serial Cable (1:1 Control), USB Type A → USB Type B

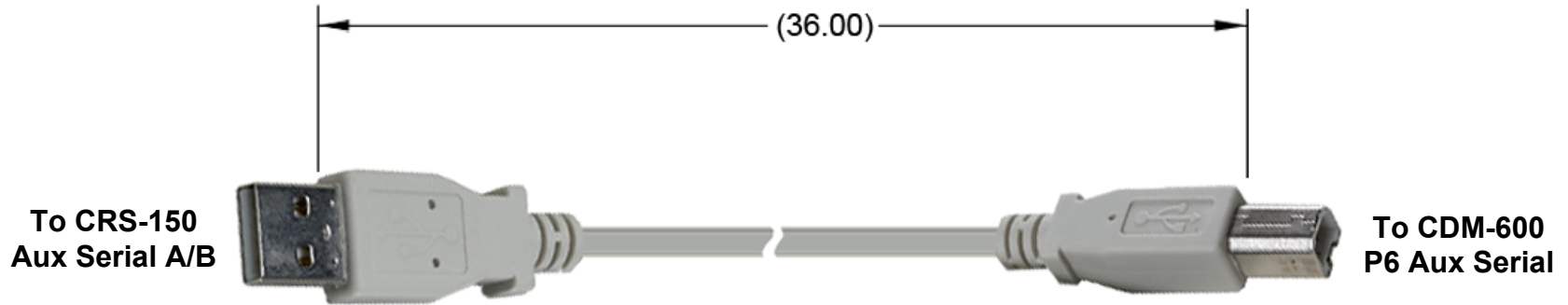

Aux Serial A/B (USB Type 'A') → CDM-600 P6 (USB Type 'B') Cable		
Pin #	Description	Direction
1	Ground	--
2	RS-232 TX Data	Out
3	RS-232 RX Data	In
4	Ground	--

Figure A-1. Auxiliary Serial Control Cable (CEFD P/N CA/USB-AM/BM-3)

A.2.2 Modem-to-Switch (CRS-150 → CRS-170A) Control/Data 'Y' Cable, DB-25M → DB-25M, DB-9M (CDM-600L [CDM-9600L])

INDICATORS			
25M	NOTES	25M	9M
1	TO	1	1
2	TO	2	
3	TO	3	
4	TO	4	
5	TO	5	
6	TO	6	
7	TO	7	5
8	TO	8	
9	TO	9	
10	TO	10	
11	TO	11	
12	TO	12	
13	TO	13	
14	TO	14	
15	TO	15	
16	TO	16	
17	TO	17	
18	TO	18	9
19	TO	19	
20	TO	20	
21	TO	21	
22	TO	22	
23	TO	23	7
24	TO	24	
25	TO	25	

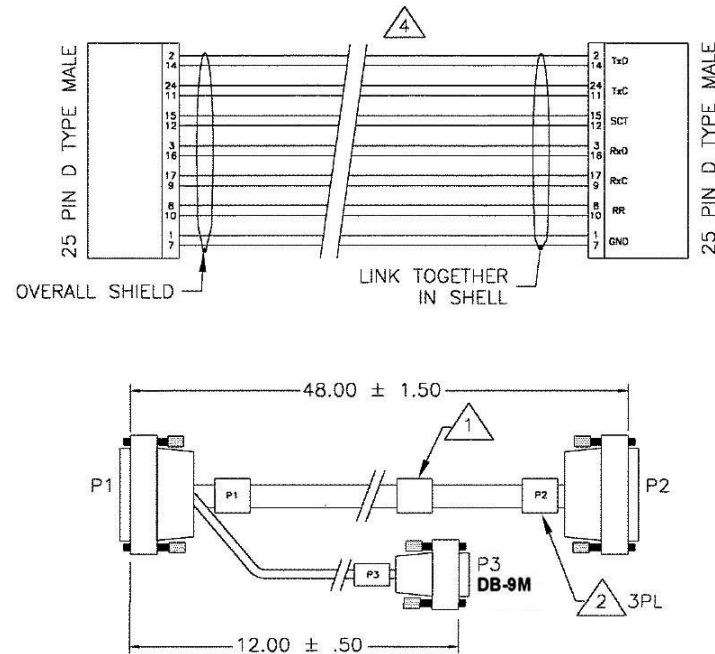

6. ALL SOLDER AND OTHER PROCESS RELATED MATERIALS MUST BE RoHS COMPLIANT PER DIRECTIVE 2002/95/EC.
5. USE METAL BACKSHELLS FOR D TYPE CONNECTORS.
4. PAIR UP TWISTED PAIRS AS SHOWN ON DRAWING. WIRE REMAINING TWISTED PAIRS STRAIGHT THRU.
3. ENSURE SHIELDING FOIL AND/OR BRAID IS BONDED TO METAL BACKSHELL FOR EMC SHIELDING.
2. MARK TERMINATION ENDS IN .12 HIGH CHARACTERS USING PERMANENT MARKING, COLOR BLACK. LOCATE APPROXIMATELY WHERE SHOWN.
1. APPLY CABLE PART NUMBER AND THE BOM REV. LETTER TO LABEL IN .12 HIGH CHARACTERS USING PERMANENT MARKING, COLOR BLACK. LOCATE APPROXIMATELY WHERE SHOWN.

NOTES: UNLESS OTHERWISE SPECIFIED:

Figure A-2. Data / Control 'Y' Cable (CEFD P/N CA/WR10456-4)

A.3 IF / Utility / Data Interface Cables

App. A FIG	REF Ch. 4 FIG	CEFD CABLE P/N	DESCRIPTION	Modem → Switch USED FOR (TYPE)
A-3	4-3	PL/0946-1	IF Coax Cable, Type 'BNC' 50Ω, 4'	IF Interface
A-4	4-4	CA/WR9564-4	Cable – DB-15M → DB-15M, 4'	IDR Alarms Utility Interface
A-5	4-5	PL/0813-4	IF Coax Cable, Type 'BNC' 75Ω, 4'	External Reference Utility Interface
A-6	4-6	PL/6233	Universal Control/Data Cable, DB-25M → DB-25M, 4'	EIA-422/232 Data Interface
				HSSI Data Interfaces
A-7	4-7	CA/WR9563-4	Cable, DB-15M → DB-15M, 4'	G.703 Balanced Data Interface
	4-8			G.703 Unbalanced Data Interface
	4-9			ASI Data Interface
	4-10			G.703 E1/T1 Balanced Data Interface
A-8	4-11	CA/WR9040-4	Cable, DB-25M → DB-25M, 4'	Overhead Data Interface
A-9	4-12	CA/WR9378-4	Cable, DB-9M → DB-9M, 4'	Audio Interface

A.3.1 Modem-to-Switch/User IF (70/140 MHz) Coax Cable, Type 'BNC' 50Ω

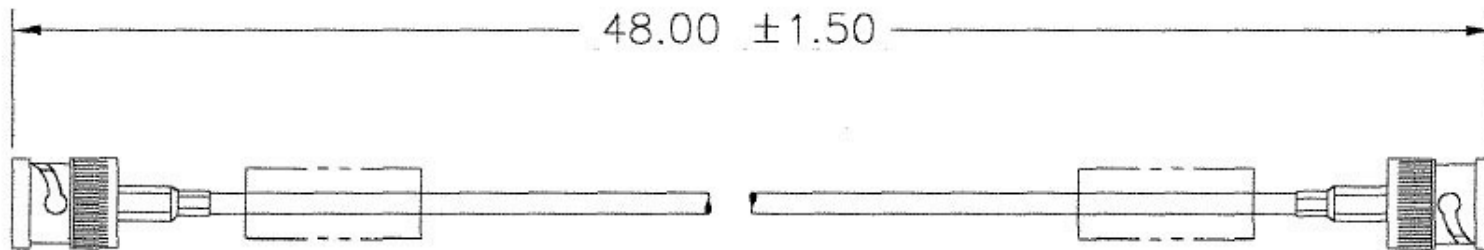
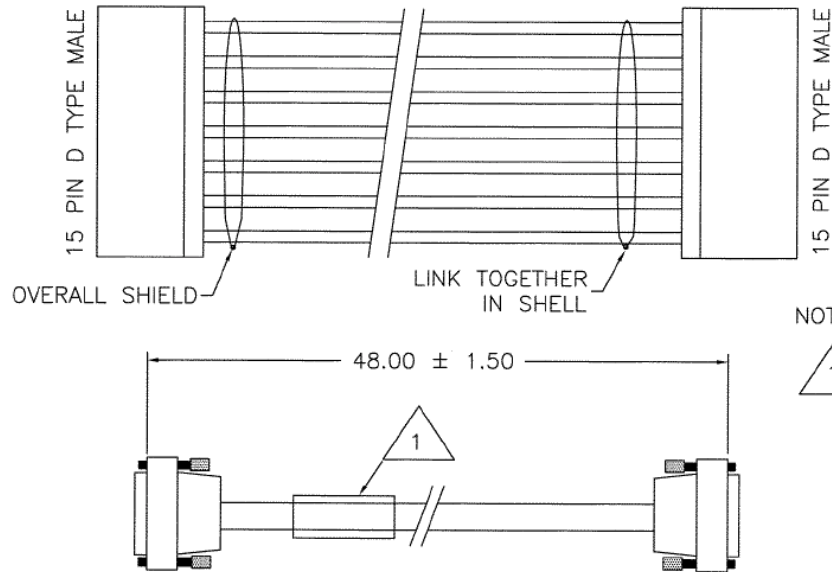

Figure A-3. Tx/Rx/User Data Type 'BNC' 50Ω Coax Cable (CEFD P/N PL/0946-1)

A.3.2 Modem-to-Switch Data Cable, DB-15M → DB-15M

INDICATORS		
15M	NOTES	15M
1	TO	1
2	TO	2
3	TO	3
4	TO	4
5	TO	5
6	TO	6
7	TO	7
8	TO	8
9	TO	9
10	TO	10
11	TO	11
12	TO	12
13	TO	13
14	TO	14
15	TO	15



NOTES: UNLESS OTHERWISE SPECIFIED:

- 1 IDENTIFY CABLE PART NUMBER AND REV LEVEL USING LABEL OR STICKER.
2. REFER TO MN/4905 FOR DETAILED INSTRUCTIONS REGARDING EMI ASSEMBLY PROCESS.
3. ENSURE SHIELDING FOIL AND/OR BRAID IS BONDED TO METAL BACKSHELL FOR EMI SHIELDING.

Figure A-4. IDR Alarms Interface Cable (CEFD P/N CA/WR9564-4)

A.3.3 Modem-to-Switch Coax Cable, Type 'BNC' 75Ω

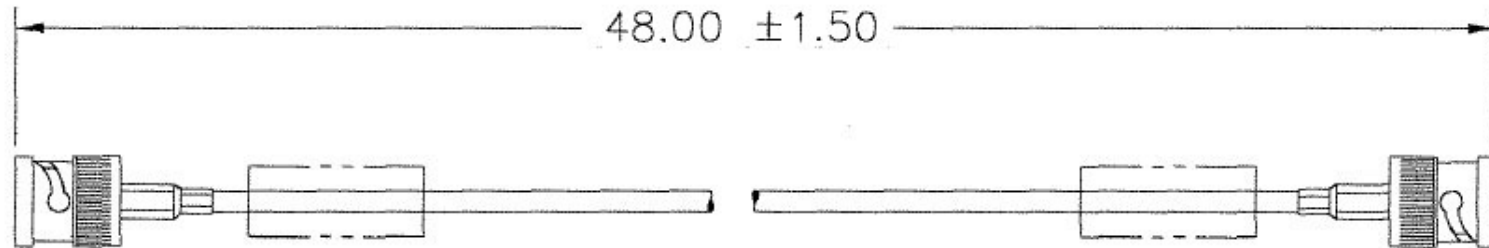
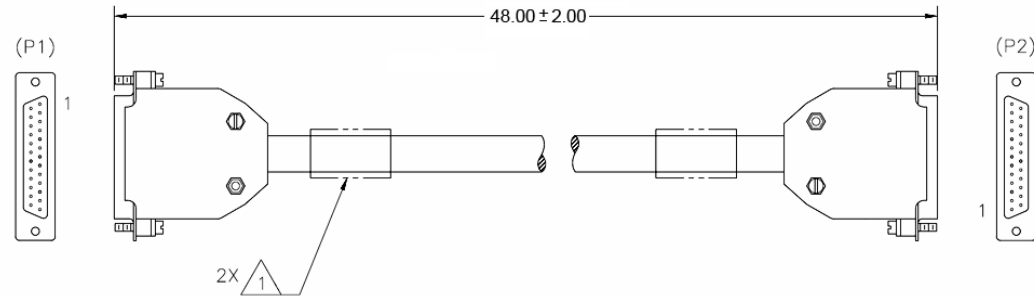

Figure A-5. External Reference Type 'BNC' 75Ω Coax Cable (CEFD P/N PL/0813-4)

A.3.4 Modem-to-Switch Universal Control/Data Cable, DB-25M → DB-25M

WIRE LIST					
FROM	TO	SIGNAL NAME			TWISTED PR.
		RS-422	RS-232	V.35	
P1-3	P2-3	RD-A	RxD	RD-A	X
P1-16	P2-16	RD-B		RD-B	
P1-2	P2-2	SD-A	TxD	SD-A	X
P1-14	P2-14	SD-B		SD-B	
P1-24	P2-24	TT-A	TxC	SCTE-A	X
P1-11	P2-11	TT-B		SCTE-B	
P1-15	P2-15	ST-A	ST	SCT-A	X
P1-12	P2-12	ST-B		SCT-B	
P1-17	P2-17	RT-A	RxC	SCR-A	X
P1-9	P2-9	RT-B		SCR-B	
P1-4	P2-4	RS-A	RTS	RTS	X
P1-19	P2-19	RS-B			
P1-5	P2-5	CS-A	CTS	CTS	X
P1-13	P2-13	CS-B			
P1-8	P2-8	RR-A	DCD	RLSD	X
P1-10	P2-10	RR-B			
P1-6	P2-6	DM-A	DSR	DSR	X
P1-22	P2-22	DM-B			
P1-20	P2-20	MC-A	MC	MC-A	X
P1-23	P2-23	MC-B		MC-B	
P1-21	P2-21	DF	DF	DF	X
P1-25	P2-25	MF	MF	MF	
P1-18	P2-18	LL	LL	LL	
P1-1	P1-7	SIGGND	SIGGND	SIGGND	X
	P2-1				
	P2-7				



NOTES: UNLESS OTHERWISE SPECIFIED

1. APPLY PART NUMBER AND REVISION TO LABEL IN .12 HIGH CHARACTERS, COLOR BLACK, USING PERMANENT INK, LOCATE APPROXIMATELY WHERE SHOWN.
2. STRIP AND/OR TIN WIRES AS REQUIRED FOR INSTALLING TERMINALS OR CONNECTORS USING MANUFACTURERS INSTALLATION PROCEDURE.
3. ALL WIRE TERMINATIONS AND UNUSED SOLDERCUPS SHALL HAVE A MINMUM OF .25 INCH OF HEAT SHRINK OVER EACH SOLDER JOINT.
4. REFER TO MN/5297 FOR DETAILED ASSEMBLY INSTRUCTIONS.

Figure A-6. 1:1 Universal Control/Data Cable (CEFD P/N PL/6233)

A.3.5 Modem-to-Switch Universal Control/Data Cable, DB-15M → DB-15M

INDICATORS		
15M	NOTES	15M
1	TO	1
2	TO	2
3	TO	3
4	TO	4
5	TO	5
6	TO	6
7	TO	7
9	TO	9
11	TO	11
12	TO	12
13	TO	13
15	TO	15

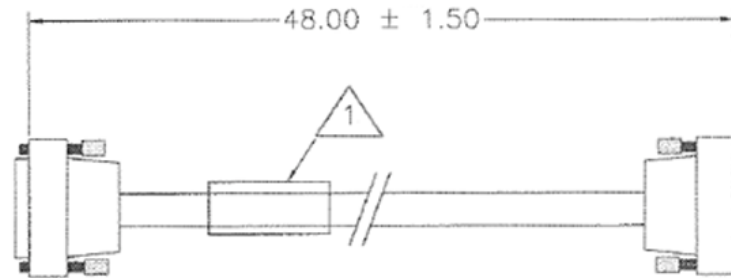
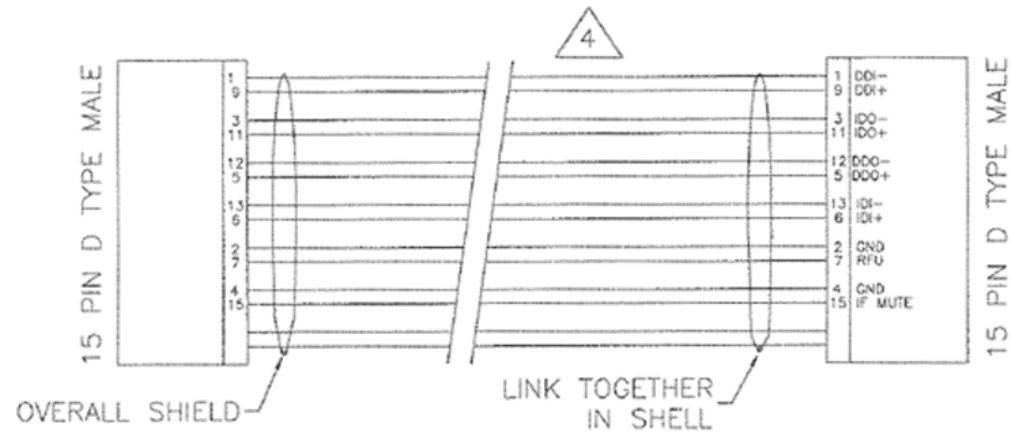

NOTES: UNLESS OTHERWISE SPECIFIED:

- 1 IDENTIFY CABLE PART NUMBER AND REV LEVEL USING LABEL OR STICKER.
- 2. REFER TO MN/4905 FOR DETAILED INSTRUCTIONS REGARDING EMI ASSEMBLY PROCESS.
- 3. ENSURE SHIELDING FOIL AND/OR BRAID IS BONDED TO METAL BACKSHELL FOR EMC SHIELDING.
- 4 PAIR UP TWISTED PAIRS AS SHOWN ON DRAWING. WIRE REMAINING TWISTED PAIRS STRAIGHT THRU.

Figure A-7. 1:1 Universal Control/Data Cable (CEFD P/N CA/WR9563-4)

A.3.6 Modem-to-Switch Data Cable, DB-25M → DB-25M

INDICATORS		
25F	NOTES	25F
1	TO	1
2	TO	2
3	TO	3
4	TO	4
5	TO	5
6	TO	6
7	TO	7
8	TO	8
9	TO	9
10	TO	10
11	TO	11
12	TO	12
13	TO	13
14	TO	14
15	TO	15
16	TO	16
17	TO	17
18	TO	18
19	TO	19
20	TO	20
21	TO	21
22	TO	22
23	TO	23
24	TO	24
25	TO	25

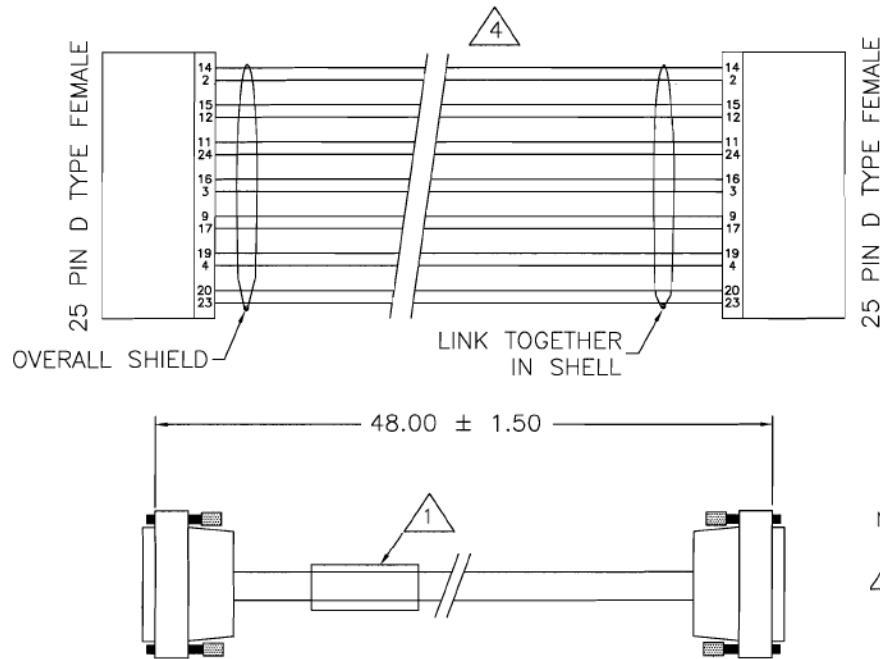

NOTES: UNLESS OTHERWISE SPECIFIED:

- 1 IDENTIFY CABLE PART NUMBER AND REV LEVEL USING LABEL OR STICKER.
2. REFER TO MN/4905 FOR DETAILED INSTRUCTIONS REGARDING EMI ASSEMBLY PROCESS.
3. ENSURE SHIELDING FOIL AND/OR BRAID IS BONDED TO METAL BACKSHELL FOR EMI SHIELDING.
- 4 PAIR UP TWISTED PAIRS AS SHOWN ON DRAWING. WIRE REMAINING TWISTED PAIRS STRAIGHT THRU.

Figure A-8. Overhead Data Cable (CEFD P/N CA/WR9040-4)

A.3.7 Modem-to-Switch Data Cable, DB-9M → DB-9M

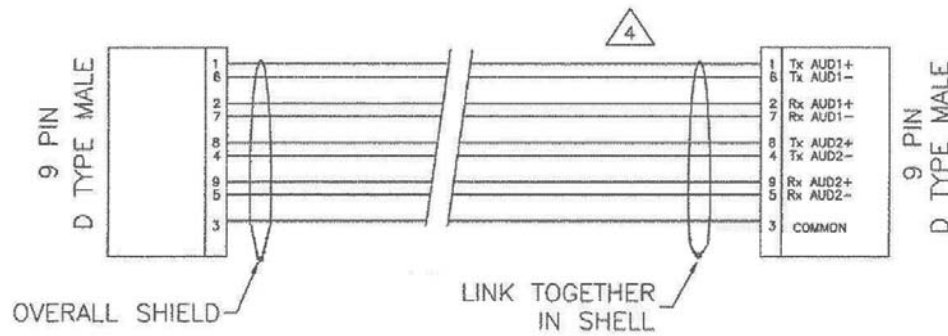

INDICATORS		
9M	NOTES	9M
1	TO	1
2	TO	2
3	TO	3
4	TO	4
5	TO	5
6	TO	6
7	TO	7
8	TO	8
9	TO	9

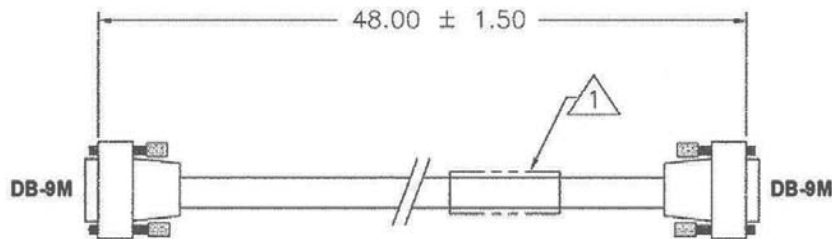

- 4** PAIR UP TWISTED PAIRS AS SHOWN ON DRAWING. WIRE REMAINING TWISTED PAIRS STRAIGHT THRU.
3. ENSURE SHIELDING FOIL AND/OR BRAID IS BONDED TO METAL BACKSHELL FOR EMI SHIELDING.
2. REFER TO MN/4905 FOR DETAILED INSTRUCTIONS REGARDING EMI ASSEMBLY PROCESS.
- 1** IDENTIFY CABLE PART NUMBER AND REV LEVEL USING LABEL OR STICKER.

NOTES: UNLESS OTHERWISE SPECIFIED:

Figure A-9. Audio Data Interface Cable (CEFD P/N CA/WR9378-4)

METRIC CONVERSIONS

Units of Length

Unit	Centimeter	Inch	Foot	Yard	Mile	Meter	Kilometer	Millimeter
1 centimeter	—	0.3937	0.03281	0.01094	6.214×10^{-6}	0.01	—	—
1 inch	2.540	—	0.08333	0.2778	1.578×10^{-5}	0.254	—	25.4
1 foot	30.480	12.0	—	0.3333	1.893×10^{-4}	0.3048	—	—
1 yard	91.44	36.0	3.0	—	5.679×10^{-4}	0.9144	—	—
1 meter	100.0	39.37	3.281	1.094	6.214×10^{-4}	—	—	—
1 mile	1.609×10^5	6.336×10^4	5.280×10^3	1.760×10^3	—	1.609×10^3	1.609	—
1 mm	—	0.03937	—	—	—	—	—	—
1 kilometer	—	—	—	—	0.621	—	—	—

Temperature Conversions

Temperature	° Fahrenheit	° Centigrade
Water freezes	32	0
Water boils	212	100
Absolute 0	-459.69	-273.16

Formulas
$^{\circ}\text{C} = (\text{F} - 32) * 0.555$
$^{\circ}\text{F} = (\text{C} * 1.8) + 32$

Units of Weight

Unit	Gram	Ounce Avoirdupois	Ounce Troy	Pound Avoirdupois	Pound Troy	Kilogram
1 gram	—	0.03527	0.03215	0.002205	0.002679	0.001
1 oz. avoird.	28.35	—	0.9115	0.0625	0.07595	0.02835
1 oz. troy	31.10	1.097	—	0.06857	0.08333	0.03110
1 lb. avoird.	453.6	16.0	14.58	—	1.215	0.4536
1 lb. Troy	373.2	13.17	12.0	0.8229	—	0.3732
1 kilogram	1.0×10^3	35.27	32.15	2.205	2.679	—



2114 WEST 7TH STREET TEMPE ARIZONA 85281 USA
480 • 333 • 2200 PHONE
480 • 333 • 2161 FAX