



# *CDM-570A*

---

70/140 MHz Satellite Modem

# *CDM-570AL*

---

L-Band Satellite Modem

# *CDMR-570AL*

---

Reduced Chassis Depth L-Band Satellite Modem

Satellite Modem with Optional High Performance  
Packet Processor  
Installation and Operation Manual  
For Firmware Version 1.5.2 or higher

**IMPORTANT NOTE:** The information contained in this document supersedes all previously published information regarding this product. Product specifications are subject to change without prior notice.





---

# *CDM-570A*

70/140 MHz Satellite Modem

---

# *CDM-570AL*

L-Band Satellite Modem

---

# *CDMR-570AL*

Reduced Chassis Depth L-Band Satellite Modem

Satellite Modem with Optional High Performance  
Packet Processor  
Installation and Operation Manual  
For Firmware Version 1.5.2 or higher

Part Number MN-CDM570A / CD-CDM570A  
Revision 5

## Revision History

Rev	Description
-	Initial Release.
1	Incorporated IP Packet Processor.
2	Incorporated information for firmware version 1.3.1.
3	Updated FAST demo mode operation and incorporated Errata's into the manual.
4	Incorporated VersaFEC-2 and Carrier ID for firmware version 1.5.2. Also added RADIUS Appendix I.
5	Revised Tables B-6 and B-7. Updated manual header and footer formatting. Added Revision History and Acronym tables.

# TABLE OF CONTENTS

<b>Chapter 1. INTRODUCTION.....</b>	<b>1-1</b>
<b>1.1 Overview.....</b>	<b>1-1</b>
1.1.1 Modem Features Overview .....	1-1
1.1.2 Functional Description.....	1-2
<b>1.2 Features .....</b>	<b>1-4</b>
1.2.1 Physical Description .....	1-4
1.2.1.1 Standard Assemblies.....	1-4
1.2.1.2 Optional Assemblies.....	1-4
1.2.2 Dimensional Envelope .....	1-5
1.2.3 Physical Features.....	1-6
1.2.3.1 Front Panel Features .....	1-6
1.2.3.2 Rear Panel Features.....	1-7
1.2.3.2.1 Rear Panel Standard Features.....	1-7
1.2.3.2.2 Rear Panel Optional Features .....	1-9
1.2.4 Standard Data Interfaces.....	1-9
1.2.5 Verification .....	1-9
1.2.6 AUPC.....	1-10
1.2.7 EDMAC.....	1-10
1.2.8 Updating Modem Firmware .....	1-10
1.2.9 Fully Accessible System Topology (FAST).....	1-11
1.2.10 Supporting Hardware and Software.....	1-14
1.2.10.1 CDM-570AL/CDMR-570AL L-Band Redundancy.....	1-14
1.2.10.2 CDM-570A 70/140 MHz Redundancy .....	1-14
1.2.10.3 Support Software .....	1-14
<b>1.3 Summary of Specifications.....</b>	<b>1-15</b>
1.3.1 Modulator.....	1-15
1.3.2 Demodulator .....	1-18
1.3.2.1 BER Performance Specification .....	1-18
1.3.3 Standard AUPC (Automatic Uplink Power Control) .....	1-21
1.3.4 DoubleTalk® Carrier- in-Carrier® (CnC).....	1-22
1.3.5 Data and Miscellaneous Interfaces .....	1-23
1.3.6 Data Rate Ranges.....	1-24
1.3.7 VersaFEC Adaptive Coding and Modulation (ACM).....	1-25
1.3.7.1 VersaFEC ACM (IP-ACM) .....	1-25
1.3.7.2 VersaFEC-2 ACM (V2-ACM) .....	1-26
1.3.8 Power.....	1-27
1.3.9 Physical Properties.....	1-27
1.3.10 Miscellaneous.....	1-28
1.3.11 Approvals.....	1-28
<b>CHAPTER 2. INSTALLATION AND STARTUP.....</b>	<b>2-1</b>

<b>2.1</b>	<b>Unpack and Inspect the Shipment.....</b>	<b>2-1</b>
<b>2.2</b>	<b>Install the Modem into a Rack Enclosure .....</b>	<b>2-2</b>
2.2.1	Install the Optional Rear Support Brackets Kit .....	2-4
<b>2.3</b>	<b>Configure the Modem.....</b>	<b>2-5</b>
<b>2.4</b>	<b>Verify Operation (IF Loopback Test).....</b>	<b>2-5</b>
<b>2.5</b>	<b>Connect the External Cables .....</b>	<b>2-6</b>
<b>CHAPTER 3. REAR PANEL CONNECTORS AND PINOUTS .....</b>		<b>3-1</b>
<b>3.1</b>	<b>Overview – Cabling Connection Types.....</b>	<b>3-1</b>
3.1.1	Coaxial Cable Connections .....	3-2
3.1.1.1	Type ‘BNC’ .....	3-3
3.1.1.2	Type ‘TNC’ .....	3-3
3.1.1.3	Type ‘N’ .....	3-3
3.1.1.4	Type ‘F’ .....	3-3
3.1.1.5	Type ‘SMA’ (Subminiature Version ‘A’).....	3-3
3.1.2	D-Subminiature Cable Connections .....	3-4
3.1.3	RJ-XX Cable Connections .....	3-4
<b>3.2</b>	<b>Modem Cabling Connections .....</b>	<b>3-5</b>
3.2.1	IF Connections Group .....	3-6
3.2.1.1	Rx IF Connectors .....	3-6
3.2.1.2	Tx IF Connectors .....	3-6
3.2.2	Terrestrial Data Connections Group.....	3-7
3.2.2.1	Data Interface Connector, DB-25F .....	3-7
3.2.2.2	10/100 Ethernet   Traffic 100 Port, RJ-45 (w/Optional Packet Processor only).....	3-8
3.2.2.3	G.703 Connections .....	3-9
3.2.2.3.1	Unbal E1 Out/In G.703 Connectors (Tx/Rx), 75Ω BNC.....	3-9
3.2.2.3.2	Balanced E1/T1 G.703 Connector, DB-15F .....	3-9
3.2.2.3.3	G.703 RJ-48 Connection via Balanced E1/T1 Interface Connector .....	3-10
3.2.3	Utility Connections Group .....	3-11
3.2.3.1	10/100 Ethernet   M&C 100 Port, RJ-45 (Standard) .....	3-11
3.2.3.2	Remote Control Connector, DB-9M.....	3-11
3.2.3.3	Alarms (Form-C Traffic Alarms) Connector, DB-15M .....	3-11
3.2.3.4	1:1 Control Connector, DB-9F.....	3-12
3.2.3.5	Ext Ref In/Out Connector, BNC .....	3-13
3.2.3.6	Console Port, RJ-11 (w/Optional Packet Processor only) .....	3-13
<b>3.3</b>	<b>Modem Ground, Power, and Fuse Connections.....</b>	<b>3-14</b>
3.3.1	Chassis Ground Interface .....	3-14
3.3.2	Standard Alternating Current (AC) Power and Fusing Interfaces.....	3-15
3.3.2.1	AC Operation – Standard or Available Accessories.....	3-15
3.3.2.2	AC Operation – Chassis Power and Fusing .....	3-16
3.3.2.2.1	AC Operation – Apply Power .....	3-17

3.3.2.2.2	AC Operation – Replace the Fuses .....	3–17
3.3.3	Modem Optional -24V or -48V DC Power Interfaces .....	3–18
3.3.3.1	Optional DC Operation – Available Accessories .....	3–18
3.3.3.2	Optional -24V or -48V DC Chassis Power and Fusing .....	3–19
3.3.3.2.1	Optional DC Operation – Apply Power .....	3–19
3.3.3.2.2	Optional DC Operation – Replace the DC Power Fuses .....	3–20
3.3.3.3	CDMR-570AL Reduced Chassis Depth Modem -24 or -48V DC Power and Fuse .....	3–21
3.3.3.3.1	CDMR-570AL – Apply DC Power .....	3–21
3.3.3.4	CDMR-570AL – Replace the DC Power Fuse .....	3–22
<b>CHAPTER 4.</b>	<b>UPDATING FIRMWARE .....</b>	<b>4–1</b>
<b>4.1</b>	<b>Overview .....</b>	<b>4–1</b>
4.1.1	About Firmware Files, Naming, Versions, and Archive Formats .....	4–2
<b>4.2</b>	<b>Ethernet FTP Upload Procedure .....</b>	<b>4–3</b>
4.2.1	Getting Started: Prepare for the Firmware Download .....	4–3
4.2.2	Download and Extract the Firmware Update .....	4–8
4.2.3	Perform the Ethernet FTP Upload Procedure .....	4–10
<b>CHAPTER 5.</b>	<b>FAST ACTIVATION PROCEDURE.....</b>	<b>5–1</b>
<b>5.1</b>	<b>Overview .....</b>	<b>5–1</b>
<b>5.2</b>	<b>FAST Activation Procedure.....</b>	<b>5–2</b>
5.2.1	FAST Activation via the Modem Front Panel .....	5–2
5.2.2	FAST Activation via the CDM-570A HTTP Interface .....	5–4
<b>CHAPTER 6.</b>	<b>FRONT PANEL OPERATION .....</b>	<b>6–1</b>
<b>6.1</b>	<b>Overview .....</b>	<b>6–1</b>
6.1.1	LED Indicators.....	6–2
6.1.2	Keypad .....	6–3
6.1.3	Vacuum Fluorescent Display (VFD) .....	6–3
6.1.3.1	Screen Saver.....	6–4
6.1.3.2	Opening Screen .....	6–4
<b>6.2</b>	<b>Compatible Mode Operation (CDM-570A/570AL vs. CDM-570/570L).....</b>	<b>6–5</b>
<b>6.3</b>	<b>Front Panel Operation .....</b>	<b>6–6</b>
6.3.1	SELECT: (Main) Menu .....	6–7
6.3.2	(SELECT:) Config (Configuration) Menus .....	6–8
6.3.2.1	CONFIG: Rem (Remote Control).....	6–9
6.3.2.1.1	(CONFIG: Remote Control) Serial.....	6–9
6.3.2.1.2	(CONFIG:) Remote Control: Ethernet .....	6–10
6.3.2.2	CONFIG: All.....	6–13
6.3.2.3	CONFIG: Tx (Transmit).....	6–14
6.3.2.3.1	(CONFIG: Tx) FEC (FEC Encoder Type).....	6–15

6.3.2.3.2	(CONFIG: Tx) Mod (Modulation Type)	6-17
6.3.2.3.3	(CONFIG: Tx) Code (Code Rate)	6-17
6.3.2.3.4	(CONFIG: Tx) Data (Data Rate)	6-18
6.3.2.3.5	(CONFIG: Tx) Symb (IP-ACM or V2-ACM Modes Only)	6-22
6.3.2.3.6	(CONFIG: Tx) Frq (Frequency)	6-22
6.3.2.3.7	(CONFIG: Tx) On/Off	6-23
6.3.2.3.8	(CONFIG: Tx) Pwr (Power)	6-23
6.3.2.3.9	(CONFIG: Tx) Scr (Scrambling)	6-25
6.3.2.3.10	(CONFIG: Tx) Clk (Clock Source)	6-26
6.3.2.3.11	(CONFIG: Tx) Inv (Inversion Functions)	6-26
6.3.2.3.12	(Config: Tx) $\alpha$ (Tx Alpha Filter Rolloff Factor)	6-27
6.3.2.4	CONFIG: Rx (Receive)	6-27
6.3.2.4.1	(CONFIG: Rx) FEC (FEC Decoder Type)	6-28
6.3.2.4.2	(CONFIG: Rx) Dem (Demodulation Type)	6-30
6.3.2.4.3	(CONFIG: Rx) Code (Code Rate)	6-30
6.3.2.4.4	(CONFIG: Rx) Data (Data Rate)	6-31
6.3.2.4.5	(CONFIG: Rx) Symb (IP-ACM (VersaFEC ACM) or V2-ACM (VersaFEC-2 ACM) Modes Only)	6-31
6.3.2.4.6	(CONFIG: Rx) Frq (Frequency)	6-32
6.3.2.4.7	(CONFIG: Rx) Acq (Acquisition Range)	6-32
6.3.2.4.8	(CONFIG: Rx) Descram (Descrambling)	6-33
6.3.2.4.9	(CONFIG: Rx) Buf (Buffer)	6-33
6.3.2.4.10	(CONFIG: Rx) Inv (Inversion Functions)	6-34
6.3.2.4.11	(CONFIG: Rx) Eb/No	6-34
6.3.2.4.12	(CONFIG: Rx) SNR (IP-ACM (VersaFEC ACM) or V2-ACM (VersaFEC-2 ACM) Modes Only)	6-35
6.3.2.4.13	(Config: Rx) $\alpha$ (Rx Alpha Filter Rolloff Factor)	6-35
6.3.2.5	CONFIG: CEx (G.703 Clock Extension)	6-35
6.3.2.6	CONFIG: Frame (Framing Mode)	6-36
6.3.2.6.1	(CONFIG: Framing Mode) EDMAC or EDMAC-2	6-36
6.3.2.7	CONFIG: TI (Data Traffic Interface)	6-38
6.3.2.7.1	(CONFIG: TI) RS422 or V.35 or RS232	6-38
6.3.2.7.2	(CONFIG: TI) IP	6-38
6.3.2.7.3	(CONFIG: TI) G.703	6-38
6.3.2.7.4	IP-ACM (VersaFEC ACM)	6-39
6.3.2.7.5	V2-ACM (VersaFEC-2 ACM)	6-40
6.3.2.8	CONFIG: Ref (Reference)	6-42
6.3.2.9	CONFIG: Msk (Alarm Masking)	6-43
6.3.2.9.1	(CONFIG: Alarm Mask) Transmit	6-43
6.3.2.9.2	(CONFIG: Alarm Mask) Receive	6-43
6.3.2.9.3	(CONFIG: Alarm Mask) Ref	6-44
6.3.2.9.4	(CONFIG: Alarm Mask) BUC (CDM/R-570AL L-Band Units ONLY)	6-44
6.3.2.9.5	(CONFIG: Alarm Mask) LNB (CDM/R-570AL L-Band Units ONLY)	6-44
6.3.2.10	CONFIG: CnC	6-45
6.3.2.10.1	(CONFIG: CnC) Mode	6-45
6.3.2.10.3	(CONFIG: CnC) Search-Delay	6-46
6.3.2.11	CONFIG: ODU (CDM/R-570AL L-Band Units ONLY)	6-46
6.3.3	SELECT: Monitor	6-47



6.3.3.1	MONITOR: Alarms .....	6-47
6.3.3.1.1	(MONITOR: Live Alarms) Unit .....	6-48
6.3.3.1.2	(MONITOR: Live Alarms) Receive (Receive Traffic Status).....	6-48
6.3.3.1.3	(MONITOR: Live Alarms) Transmit (Transmit Traffic Status) .....	6-48
6.3.3.2	MONITOR: Rx.....	6-48
6.3.3.3	Monitor: ACM.....	6-49
6.3.3.4	MONITOR: Event (Stored Events) .....	6-50
6.3.3.4.1	(MONITOR: Stored Events) View .....	6-50
6.3.3.4.2	(MONITOR: Stored Events) Clear-All.....	6-50
6.3.3.5	MONITOR: Stats (Link Statistics).....	6-51
6.3.3.5.1	(MONITOR: Stats (Link Statistics)) View.....	6-51
6.3.3.5.2	(MONITOR: Stats (Link Statistics)) Clear-All .....	6-53
6.3.3.5.3	(MONITOR: Stats (Link Statistics)) Config (Configure) .....	6-53
6.3.3.6	MONITOR: AUPC .....	6-54
6.3.3.7	MONITOR: CnC .....	6-55
6.3.3.8	MONITOR: ODU (CDM/R-570AL L-Band Units ONLY) .....	6-55
6.3.4	SELECT: TEST .....	6-55
6.3.4.1	TEST: Mode .....	6-56
6.3.4.2	TEST: BERT.....	6-58
6.3.5	SELECT: Info .....	6-59
6.3.5.1	INFO: All.....	6-59
6.3.5.2	INFO: Tx (Transmit).....	6-59
6.3.5.3	INFO: Rx (Receive) .....	6-60
6.3.5.4	INFO: Buf (Buffer) .....	6-60
6.3.5.5	INFO: Frame (Framing and EDMAC) .....	6-60
6.3.5.6	INFO: Intfc (Interface).....	6-61
6.3.5.7	INFO: Rem (Remote Control).....	6-61
6.3.5.8	INFO: Msk (Alarm Mask) .....	6-61
6.3.5.9	INFO: Ref (Frequency Reference).....	6-62
6.3.5.10	INFO: ID .....	6-62
6.3.5.11	INFO: 1:1 (1:1 Redundancy).....	6-62
6.3.6	SELECT: Save/Load .....	6-62
6.3.6.1	(Save/Load Configuration:) Save .....	6-62
6.3.6.2	(Save/Load Configuration:) Load.....	6-63
6.3.7	SELECT: Util (Utility) .....	6-64
6.3.7.1	UTIL: Buf (Buffer Re-CENTER) .....	6-64
6.3.7.2	UTIL: Clock (Set Real-time Clock).....	6-64
6.3.7.3	UTIL: Ref (Reference) .....	6-64
6.3.7.3.1	(Internal Freq Ref:) Adjust .....	6-65
6.3.7.3.2	(Internal Freq Ref:) Warm-up Delay .....	6-65
6.3.7.4	UTIL: CMO .....	6-66
6.3.7.5	UTIL: ID (Circuit ID).....	6-66
6.3.7.5.1	UTIL: 1:1 (Manual 1:1 Switchover).....	6-66
6.3.7.6	UTIL: VFD (Video Fluorescent Display Brightness).....	6-67
6.3.7.7	UTIL: FW (Firmware Images) .....	6-67
6.3.7.7.1	(UTIL: FW Images) Info.....	6-67
6.3.7.7.2	(UTIL: FW Images) Select .....	6-68
6.3.7.8	UTIL: FAST (FAST Code Options).....	6-68

6.3.7.8.1	(UTIL: FAST) Cnfg (FAST Configuration) .....	6-69
6.3.7.8.2	(UTIL: FAST) View .....	6-69
6.3.7.9	UTIL: CID (Carrier ID).....	6-71
6.3.7.9.1	UTIL: CID (Carrier ID) Latitude.....	6-71
6.3.7.9.2	UTIL: CID (Carrier ID) Longitude.....	6-71
6.3.7.9.3	UTIL: CID (Carrier ID) Phone#.....	6-72
6.3.7.9.4	UTIL: CID (Carrier ID) Message.....	6-72
6.3.8	SELECT: ODU (CDM-570A 70/140 MHz Unit ONLY).....	6-72

**CHAPTER 7. ETHERNET-BASED REMOTE PRODUCT MANAGEMENT ..... 7-1**

<b>7.1</b>	<b>Overview .....</b>	<b>7-1</b>
7.1.1	Ethernet Management Interface Protocols.....	7-2
<b>7.2</b>	<b>SNMP Interface .....</b>	<b>7-2</b>
7.2.1	Management Information Base (MIB) Files.....	7-3
7.2.2	SNMP Community Strings .....	7-3
7.2.3	SNMP Traps .....	7-4
7.2.4	MIB-II.....	7-5
7.2.5	Private MIB .....	7-6
7.3.1	Telnet Operation via HyperTerminal.....	7-6
<b>7.4</b>	<b>CDM-570A HTTP (Web Server) Interface .....</b>	<b>7-8</b>
7.4.1	Operational Features.....	7-8
7.4.1.1	User Login.....	7-8
7.4.1.2	Navigation .....	7-9
7.4.1.3	Page Sections .....	7-9
7.4.1.4	Action Buttons .....	7-10
7.4.1.5	Drop-down Lists.....	7-10
7.4.1.6	Text or Data Entry.....	7-10
7.4.2	CDM-570A HTTP Interface – Menu Tree .....	7-10
7.4.2.1	HTTP Interface – IMPORTANT Conditional Operating Notes.....	7-11
7.4.3	CDM-570A HTTP Interface Page Descriptions .....	7-13
7.4.3.1	Home Pages .....	7-13
7.4.3.1.1	Home   Home .....	7-13
7.4.3.1.2	Home   Contact .....	7-14
7.4.3.1.3	Home   Support.....	7-15
7.4.3.2	Admin Pages .....	7-16
7.4.3.2.1	Admin   Access .....	7-16
7.4.3.2.2	Admin   SNMP .....	7-18
7.4.3.2.3	Admin   Working Mode .....	7-19
7.4.3.2.4	Admin   PaP Features .....	7-20
7.4.3.2.5	Admin   Firmware.....	7-21
7.4.3.2.5.1	Admin   Firmware   Modem .....	7-21
7.4.3.2.5.2	Admin   Firmware   Packet Processor.....	7-23
7.4.3.2.6	Admin   FAST .....	7-23
7.4.3.2.7	Admin   Remote Authentication Dial In User Service (RADIUS).....	7-25
7.4.3.2.8	Admin   PaP Save.....	7-26

7.4.3.2.9	Admin   Reboot .....	7-27
7.4.3.3	Configuration Pages .....	7-28
7.4.3.3.1	Configuration   Modem.....	7-28
7.4.3.3.2	Configuration   LAN .....	7-33
7.4.3.3.3	Configuration   ARP .....	7-35
7.4.3.3.4	Configuration   Routing Pages.....	7-36
7.4.3.3.6.2	Configuration   WAN   Compression .....	7-51
7.4.3.3.6.3	Configuration   WAN   HDLC.....	7-52
7.4.3.3.7	Configuration   Overhead.....	7-53
7.4.3.3.8	Configuration   Utilities   Utilities 1 .....	7-55
7.4.3.3.8.1	Configuration   Utilities   Carrier ID (MetaCarrier).....	7-58
7.4.3.3.9	Configuration   BUC (CDM/R-570AL Only).....	7-59
7.4.3.3.10	Configuration   LNB (CDM/R-570AL Only) .....	7-60
7.4.3.4	Status Pages .....	7-61
7.4.3.4.1	Status   Modem Status .....	7-61
7.4.3.4.2	Status   System Logs   Modem .....	7-63
7.4.3.4.3	Status   Modem Info.....	7-65
7.4.3.4.4	Status   Traffic Statistics Pages.....	7-66
7.4.3.4.4.1	Status   Traffic Statistics   Ethernet .....	7-66
7.4.3.4.4.2	Status   Traffic Statistics   Router .....	7-68
7.4.3.4.4.3	Status   Traffic Statistics   WAN .....	7-70
7.4.3.4.4.4	Status   Traffic Statistics   Compression .....	7-71
7.4.3.4.4.5	Status   Traffic Statistics   QoS.....	7-72
7.4.3.4.4.6	Status   Traffic Statistics   Clear Counter .....	7-73
7.4.3.4.5	Status   Performance.....	7-73
7.4.3.4.6	Status   Graph Pages .....	7-74
7.4.3.4.6.1	Status   Graph   Constellation.....	7-74
7.4.3.4.6.2	Status   Graph   Spectrum .....	7-75
7.4.3.5	ODU Pages Summary (CDM-570A Only) .....	7-76
7.4.3.6	Redundancy Page.....	7-77
 <b>CHAPTER 8. SERIAL-BASED REMOTE PRODUCT MANAGEMENT.....</b>		<b>8-1</b>
<b>8.1</b>	<b>Overview .....</b>	<b>8-1</b>
<b>8.2</b>	<b>EIA-485 .....</b>	<b>8-1</b>
<b>8.3</b>	<b>EIA-232 .....</b>	<b>8-2</b>
<b>8.4</b>	<b>Basic Protocol .....</b>	<b>8-2</b>
8.4.1	Packet Structure.....	8-3
8.4.1.1	Start of Packet.....	8-4
8.4.1.2	Target Address.....	8-4
8.4.1.3	Address Delimiter .....	8-4
8.4.1.4	Instruction Code .....	8-4
8.4.1.5	Instruction Code Qualifier .....	8-4
8.4.1.6	Optional Message Arguments.....	8-6
8.4.1.7	End of Packet .....	8-6

<b>8.5</b>	<b>Remote Commands and Queries.....</b>	<b>8-7</b>
8.5.1	Table Indexes.....	8-7
8.5.2	Transmit (Tx) Parameter Commands and Queries.....	8-10
8.5.3	Receive (Rx) Parameter Commands and Queries .....	8-18
8.5.4	Unit Parameter Commands and Queries.....	8-24
8.5.5	Bulk Configuration Commands and Queries .....	8-39
8.5.6	Modem Information Commands and Queries .....	8-43
8.5.7	Modem Performance Information.....	8-49
8.5.8	BUC (L-Band Block Up Converter) Commands and Queries (CDM/R-570AL ONLY).....	8-58
8.5.9	LNB (L-Band Low-noise Block Down Converter) Commands and Queries (CDM/R-570AL ONLY).....	8-61

## CHAPTER 9. OPTIONAL PACKET PROCESSOR – SERIAL/TELNET CLI OPERATION .9-1

<b>9.1</b>	<b>Overview .....</b>	<b>9-1</b>
9.1.1	Access to the CLI.....	9-1
9.1.1.1	Connect to the Serial CLI .....	9-2
9.1.1.2	Connect to the Telnet CLI.....	9-3
<b>9.2</b>	<b>Command Line Interface (CLI) .....</b>	<b>9-4</b>
9.2.1	CLI Menus – Common Navigation and Operation Features.....	9-5
<b>9.3</b>	<b>CLI Operations .....</b>	<b>9-7</b>
9.3.1	CLI Main Menu .....	9-7
9.3.2	Administration.....	9-8
9.3.2.1	Administration > Name/Password Configuration.....	9-9
9.3.2.2	Administration > Access Lists.....	9-10
9.3.2.3	Administration > Feature Configuration.....	9-11
9.3.2.3.1	Administration > Feature Configuration >RADIUS Configuration.....	9-14
9.3.2.4	Administration > 3xDES Configuration .....	9-15
9.3.2.5	Administration > SNMP Configuration .....	9-15
9.3.2.6	Administration > Working Mode .....	9-16
9.3.2.7	Administration > Managed Switch Multicast Option .....	9-17
9.3.2.8	Administration > Header Compression Refresh Rates .....	9-17
9.3.2.9	Administration > Payload Compression Refresh Rate.....	9-17
9.3.2.10	Administration > Telnet Timeout .....	9-18
9.3.3	Interface Configuration .....	9-19
9.3.3.1	Interface Configuration > Ethernet Interface .....	9-19
9.3.3.1.1	Interface Configuration > Ethernet Interface (Managed Switch Mode).....	9-20
9.3.3.1.1.1	Interface Configuration > Ethernet Interface > VLAN Table .....	9-22
9.3.3.1.2	Ethernet Interface (Router Mode).....	9-23
9.3.3.2	Interface Configuration > Satellite/HDLC Interface .....	9-25
9.3.3.3	Interface Configuration > Receive HDLC Channel Addresses .....	9-25
9.3.4	QoS (Quality of Service) Configuration.....	9-26
9.3.4.1	QoS Configuration > QoS Rules Configuration .....	9-27
9.3.4.1.1	QoS Rules Configuration (Max/Priority Mode).....	9-27
9.3.4.1.2	QoS Rules Configuration (Min/Max Mode) .....	9-29
9.3.4.2	QoS Configuration > DiffServ Rules Configuration.....	9-30
9.3.5	Route Table Configuration .....	9-31

9.3.5.1	Route Table > Per Route Configuration .....	9-33
9.3.6	Protocol Configuration .....	9-34
9.3.6.1	Protocol Configuration > IGMP Information .....	9-34
9.3.6.2	Protocol Configuration > ARP Table Utilities .....	9-37
9.3.6.3	Protocol Configuration > Brouter Configuration.....	9-38
9.3.7	Vipersat Configuration.....	9-40
9.3.8	Satellite Modem.....	9-41
9.3.8.1	Satellite Modem > Configuration .....	9-41
9.3.8.1.1	Satellite Modem > Configuration > Tx Configuration .....	9-42
9.3.8.1.2	Satellite Modem > Configuration > Rx Configuration .....	9-46
9.3.8.1.3	Satellite Modem > Configuration > Framing Mode Configuration .....	9-49
9.3.8.1.4	Satellite Modem > Configuration > Data Interface Configuration.....	9-50
9.3.8.1.5	Satellite Modem > Configuration > Reference Configuration .....	9-50
9.3.8.1.6	Satellite Modem > Configuration > Alarm Mask Configuration .....	9-51
9.3.8.1.7	Satellite Modem > Configuration > BUC (Block Up Converter) Configuration .....	9-52
9.3.8.1.8	Satellite Modem > Configuration > LNB (Low Noise Block Converter) Configuration .....	9-53
9.3.8.1.9	Satellite Modem > Configuration > CnC Configuration .....	9-54
9.3.8.1.10	Satellite Modem > Configuration > BERT Configuration.....	9-55
9.3.8.2	Satellite Modem > Monitor .....	9-56
9.3.8.2.1	Satellite Modem > Monitor > Stored Events .....	9-57
9.3.8.2.2	Satellite Modem > Monitor > Link Statistics.....	9-58
9.3.8.2.3	Satellite Modem > Monitor > BUC Status.....	9-59
9.3.8.2.4	Satellite Modem > Monitor > LNB Monitor .....	9-59
9.3.8.2.5	Satellite Modem > Monitor > CnC Monitor .....	9-60
9.3.8.3	Satellite Modem > Information.....	9-60
9.3.8.4	Satellite Modem > Utilities .....	9-61
9.3.8.4.1	Satellite Modem > Utilities > Carrier ID Configuration .....	9-62
9.3.10.2.1	Operations and Maintenance > Statistics Menu> IP Statistics .....	9-69
9.3.10.2.1.1	Operations and Maintenance > Statistics Menu> IP Statistics > Filter/Drop Statistics .....	9-70
9.3.10.2.2	Operations and Maintenance > Statistics Menu> QoS Statistics.....	9-73
9.3.10.2.3	Operations and Maintenance > Statistics Menu> Ethernet Statistics .....	9-74
9.3.10.2.4	Operations and Maintenance > Statistics Menu> WAN Statistics.....	9-76
9.3.10.2.5	Operations and Maintenance > Statistics Menu> Compression Statistics .....	9-78
9.3.10.2.6	Operations and Maintenance > Statistics Menu> CPU Statistics .....	9-79
9.3.10.2.7	Operations and Maintenance > Statistics Menu> VLAN Statistics .....	9-79
9.3.10.2.8	Operations and Maintenance > Statistics Menu> Active Flow Statistics.....	9-80
9.3.10.3	Operations and Maintenance > Event Log.....	9-80
9.3.10.4	Operations and Maintenance > Database Operations.....	9-83
9.3.10.5	Operations and Maintenance > Diagnostics .....	9-84
<b>CHAPTER 10. ODU (TRANSCEIVER, BUC, LNB) M&amp;C OPERATIONS.....</b>		<b>10-1</b>
<b>10.1</b>	<b>Overview.....</b>	<b>10-1</b>
10.1.1	CDM-570A/570AL Front Panel Operation – Overview .....	10-2
10.1.2	CDM-570A HTTP Interface – Overview .....	10-2
10.1.3	CDM-570A/570AL Serial Remote Control – Overview.....	10-3

<b>10.2</b>	<b>Transceiver M&amp;C via the CDM-570A (70/140 MHz) Satellite Modem .....</b>	<b>10-5</b>
10.2.1	Transceiver M&C via the CDM-570A Front Panel .....	10-5
10.2.1.1	SELECT: (Main) Menu.....	10-6
10.2.1.2	(SELECT:) ODU.....	10-6
10.2.1.2.1	(SELECT:) ODU – CSAT-5060 Transceiver Operation.....	10-7
10.2.1.2.1.1	(ODU: Transceiver Control) Enable.....	10-7
10.2.1.2.1.1.1	COMMON ‘ODU SELECT’ SUBMENU.....	10-10
10.2.1.2.1.1.1.1	(ODU SELECT:) Config.....	10-10
10.2.1.2.1.1.1.2	(ODU SELECT:) Info (Information).....	10-14
10.2.1.2.1.1.1.3	(ODU SELECT:) Monitor.....	10-15
10.2.1.2.1.1.1.4	(ODU SELECT:) Alarms.....	10-16
10.2.1.2.2	(SELECT:) ODU – KST-2000A/B Transceiver Operation .....	10-17
10.2.1.2.2.1	(ODU: Transceiver Control) Enable.....	10-18
10.2.1.2.2.1.1	(KST SELECT:) Config (KST Configuration) .....	10-18
10.2.1.2.2.1.1.1	(KST SELECT: ► KST CONFIG:) Transmitter .....	10-18
10.2.1.2.2.1.1.2	(KST SELECT: ► KST CONFIG:) Receiver.....	10-19
10.2.1.2.2.1.1.3	(KST SELECT: ► KST CONFIG:) Misc (Miscellaneous) .....	10-21
10.2.1.2.2.1.2	(KST SELECT:) INFO (Information) .....	10-21
10.2.1.2.2.1.3	(KST SELECT:) Status.....	10-24
10.2.2	Transceiver M&C via the CDM-570A’s HTTP Interface .....	10-25
10.2.2.1	ODU Pages .....	10-25
10.2.2.1.1	ODU   Enable .....	10-26
10.2.2.1.2	ODU   Config Pages .....	10-27
10.2.2.1.2.1	ODU   Config (CSAT-5060).....	10-27
10.2.2.1.2.2	ODU   Config (KST-2000A/B) .....	10-29
10.2.2.1.3	ODU   Status Pages.....	10-30
10.2.2.1.3.1	ODU   Status (CSAT-5060) .....	10-30
10.2.2.1.3.2	ODU   Status (KST-2000A/B).....	10-31
10.2.2.1.4	ODU   Utilities Pages .....	10-32
10.2.2.1.4.1	ODU   Utilities (CSAT-5060).....	10-32
10.2.2.1.4.2	ODU   Utilities (KST-2000A/B) .....	10-34
10.2.3	Transceiver M&C via CDM-570A Serial Remote Control .....	10-35
10.2.3.1	CDM-570A Transceiver Remote Control Address Setup.....	10-35
10.2.3.2	CDM-570A Transceiver Serial Remote Control Commands / Queries.....	10-36
<b>10.3</b>	<b>BUC and LNB M&amp;C via the CDM/R-570AL (L-Band) Satellite Modem .....</b>	<b>10-37</b>
10.3.1	BUC and LNB M&C via the CDM/R-570AL Front Panel.....	10-37
10.3.1.1	SELECT: (Main) Menu.....	10-38
10.3.1.1.1	(SELECT:) Config (Configuration).....	10-38
10.3.1.1.1.1	CONFIG: Msk (Alarm Masking) .....	10-38
10.3.1.1.1.2	(CONFIG: Alarm Mask) BUC .....	10-38
10.3.1.1.1.3	(CONFIG: Alarm Mask) LNB.....	10-39
10.3.1.1.2	CONFIG: ODU (Outdoor Unit) .....	10-39
10.3.1.1.2.1	(CONFIG: ODU) BUC.....	10-39
10.3.1.1.2.1.1	(CONFIG: ODU) BUC: M&C-FSK.....	10-39
10.3.1.1.2.1.2	(CONFIG: ODU) BUC: DC-Power.....	10-40
10.3.1.1.2.1.3	(CONFIG: ODU) BUC: 10MHz .....	10-40
10.3.1.1.2.1.4	(CONFIG: ODU) BUC: Alarm .....	10-40

- 10.3.1.1.2.1.5 (CONFIG: ODU) BUC: LO..... 10-41
- 10.3.1.1.2.1.6 (CONFIG: ODU) BUC: Mix..... 10-41
- 10.3.1.1.2.2 (CONFIG: ODU) LNB ..... 10-41
  - 10.3.1.1.2.2.1 (CONFIG: ODU) LNB: DC-Voltage ..... 10-41
  - 10.3.1.1.2.2.2 (CONFIG: ODU) LNB: 10MHz..... 10-41
  - 10.3.1.1.2.2.3 (CONFIG: ODU) LNB: Alarm..... 10-42
  - 10.3.1.1.2.2.4 (CONFIG: ODU) LNB: LO ..... 10-42
  - 10.3.1.1.2.2.5 (CONFIG: ODU) LNB: Mix ..... 10-43
- 10.3.1.2 (SELECT:) Monitor..... 10-43
  - 10.3.1.2.1 MONITOR: Alarms..... 10-43
    - 10.3.1.2.1.1 (MONITOR: Live Alarms) ODU..... 10-44
  - 10.3.1.2.2 MONITOR: ODU ..... 10-44
    - 10.3.1.2.2.1 (MONITOR: Outdoor Unit Monitor) BUC ..... 10-44
    - 10.3.1.2.2.2 (MONITOR: Outdoor Unit Monitor) LNB ..... 10-45
- 10.3.2 BUC and LNB M&C via the CDM-570A HTTP Interface..... 10-45
  - 10.3.2.1 ODU (BUC, LNB) Pages..... 10-46
    - 10.3.2.1.1 Configuration | BUC..... 10-46
    - 10.3.2.1.2 Configuration | LNB ..... 10-47
- 10.3.3 CDM/R-570AL BUC and LNB M&C via Serial Remote Control Commands/Queries ..... 10-48

**APPENDIX A. CABLE DRAWINGS ..... A-1**

- A.1 Overview ..... A-1
  - A.1.1 EIA-530 to EIA-422/449 Data Cable..... A-2
  - A.1.2 EIA-530 to V.35 DCE Conversion Cable ..... A-3

**APPENDIX B. FEC (FORWARD ERROR CORRECTION) OPTIONS..... B-1**

- B.1 Overview ..... B-1
- B.2 Viterbi..... B-2
- B.3 Reed-Solomon (RS) Outer Codec ..... B-3
  - B.3.1 Closed Network Modes..... B-3
- B.4 Trellis Coding Modulation (TCM) (FAST Option)..... B-4
- B.5 Turbo Product Codec (FAST Option)..... B-5
  - B.5.1 TPC Overview ..... B-5
- B.6 VersaFEC (Short-block LDPC)..... B-7
  - B.6.1 VersaFEC Extensions..... B-8
    - B.6.1.1 Extended CCM Codes..... B-8
    - B.6.1.2 Ultra-Low-Latency (ULL) Codes ..... B-9
- B.7 VersaFEC-2 ..... B-10
  - B.7.1 Field Upgrade Procedure – VersaFEC-2 Option Card..... B-15
    - B.7.1.1 Overview ..... B-15

B.7.1.2	Requirements for Field Upgrade .....	B-15
B.7.1.3	Field Upgrade Procedure .....	B-16
B.8	Uncoded Operation (No FEC).....	B-19
<b>APPENDIX C. OFFSET QPSK OPERATION.....</b>		<b>C-1</b>
<b>APPENDIX D. OPTIONAL HIGH-PERFORMANCE PACKET PROCESSOR.....</b>		<b>D-1</b>
D.1	Overview .....	D-1
D.1.1	Operational Requirements.....	D-2
D.1.1.1	Major Assemblies .....	D-2
D.1.1.2	Interoperability Compatibility/Limitations .....	D-2
D.1.1.3	High-Performance Packet Processor Field Upgrade Procedure .....	D-3
D.1.1.3.1	Overview.....	D-3
D.1.1.3.2	Requirements for Field Upgrade .....	D-3
D.1.1.3.3	Field Upgrade Procedure.....	D-4
D.1.2	High-Performance Packet Processor Features .....	D-9
D.1.2.1	10/100 BaseT Ethernet Interface .....	D-9
D.1.2.2	Network-Based Management.....	D-10
D.1.2.2.1	Remote Software/Firmware Upgrade via FTP.....	D-10
D.1.2.2.2	Configuration Backup and Restore via FTP .....	D-10
D.1.2.2.3	Event Logging to Capture All Packet Processor Activity .....	D-11
D.1.2.2.4	Detailed Statistics of IP Traffic.....	D-12
D.1.2.3	Static IP Routing for Unicast and Multicast .....	D-12
D.1.2.4	IGMP Support for Multicast.....	D-12
D.1.2.5	Managed Switch Mode .....	D-12
D.1.2.5.1	Managed Switch Mode Operation .....	D-12
D.1.2.5.2	Combined Working Mode .....	D-14
D.1.2.6	Adaptive Coding and Modulation (ACM) .....	D-15
D.1.2.7	High-Performance Packet Processor Optional FAST Features.....	D-15
D.1.2.7.1	CDM-570A/570AL-Packet Processor in Demo Mode .....	D-15
D.1.2.7.2	Header and Payload Compression .....	D-16
D.1.2.7.2.1	IP Header Compression .....	D-16
D.1.2.7.2.2	Payload Compression .....	D-17
D.1.2.7.2.3	ALDC vs. LZS Compression Comparison Table.....	D-17
D.1.2.8	Advanced Quality of Service (QoS).....	D-18
D.1.2.9	Vipersat / VFS.....	D-18
D.1.2.10	3xDES Encryption with Ability to Change Keys.....	D-18
D.1.3	CDM-570A/570AL-IP – Operation and Control .....	D-19
D.1.3.1	Front Panel Operation.....	D-19
D.1.3.2	Ethernet-based Remote Product Management .....	D-19
D.1.3.3	SNMP Interface.....	D-19
D.1.3.4	Telnet Interface .....	D-20
D.1.3.5	CDM-570A HTTP (Web Server) Interface .....	D-21
D.1.4	High-Performance Packet Processor Specifications – Supported RFCs (Requests for Comment) and Protocols.....	D-22



D.2	High-Performance Packet Processor – Quick Start Guide .....	D-23
D.2.1	Getting Started.....	D-23
D.2.1.1	Equipment List .....	D-23
D.2.1.2	Equipment Setup.....	D-23
D.2.5	Configuring a Managed Switch Point-to-Point System.....	D-25
D.2.5.1	Configure User PCs.....	D-26
D.2.5.2	Configure CDM-IP 1, CDM-IP 2 – Set IP Address(es).....	D-26
D.2.6	Configuring a Router Mode Point-to-Point System .....	D-27
D.2.6.1	Configure User PCs.....	D-28
D.2.6.2	Set CDM-IP Modems to Router Mode Operation .....	D-28
D.2.6.3	Set IP Address(es).....	D-29
D.2.6.4	Set Route Table Entries .....	D-29
D.2.7	Troubleshooting High-Performance Packet Processor Operation.....	D-31
D.2.7.1	Managed Switch Mode Troubleshooting.....	D-31
D.2.7.2	Router Mode Troubleshooting.....	D-33
D.3	High-Performance Packet Processor – Typical Operational Setups .....	D-34
D.3.1.1	High-Performance Packet Processor Working Modes .....	D-34
D.3.1.1.1	Working Modes – HDLC Encapsulation .....	D-34
D.3.1.1.2	Managed Switch Mode.....	D-36
D.3.1.1.3	Router Modes.....	D-37
D.3.1.1.3.1	Router Mode – Point-to-Point.....	D-37
D.3.1.1.3.2	Router Mode – Point-to-MultiPoint.....	D-38
D.3.1.1.3.3	Router Mode (Brouter Enabled) – Point-to-MultiPoint with VLAN Matching Filters.....	D-39
D.3.1.1.3.3.1	Brouter Mode with VLAN Filtering Configuration .....	D-40

**APPENDIX E. AUPC (AUTOMATIC UPLINK POWER CONTROL)..... E-1**

E.1	Overview .....	E-1
E.2	Setting AUPC Parameters.....	E-1
E.2.1	Target-Eb/No.....	E-2
E.2.2	Max-Range .....	E-2
E.2.3	Alarm.....	E-2
E.2.4	DemodUnlock .....	E-3
E.3	Compensation Rate.....	E-3
E.4	Monitoring .....	E-3

**APPENDIX F. CLOCKING MODES ..... F-1**

F.1	Overview .....	F-1
F.2	Transmit Clocking.....	F-1
F.2.1	Internal Clock.....	F-1
F.2.2	TX Terrestrial .....	F-2

F.2.3	RX Loop-Timed, RX=TX .....	F-2
F.2.4	RX Loop-Timed, RX<>TX (Asymmetric Loop Timing).....	F-2
F.3	Receive Clocking.....	F-4
F.3.1	Buffer Disabled (RX Satellite) .....	F-4
F.3.2	Buffer Enabled, TX=RX.....	F-4
F.3.3	Buffer Enabled, RX<>TX.....	F-4
F.4	X.21 Notes .....	F-6
F.5	G.703 Clock Extension.....	F-6
F.5.1	Clock Extension Mode 1 .....	F-7
F.5.2	Clock Extension Mode 2 .....	F-8
F.5.3	Clock Extension Mode 3 .....	F-8
<b>APPENDIX G. DOUBLETALK CARRIER-IN-CARRIER OPTION .....</b>		<b>G-1</b>
G.1	Overview .....	G-1
G.2	What is DoubleTalk Carrier-in-Carrier?.....	G-1
G.3	Application Requirements .....	G-2
G.3.1	Operational Recommendations .....	G-4
G.4	System Functionality and Operational Considerations.....	G-5
G.4.1	DoubleTalk Carrier-in-Carrier Cancellation Process .....	G-8
G.4.2	Margin Requirements.....	G-9
G.4.4	Carrier-in-Carrier and Adaptive Coding and Modulation.....	G-10
G.4.5	Carrier-in-Carrier Link Design .....	G-10
G.4.5.1	Symmetric Data Rate Link.....	G-10
G.4.5.2	Asymmetric Data Rate Link.....	G-14
G.4.5.3	Power Limited Links .....	G-15
G.4.5.4	Commission and Deploy Carrier-in-Carrier.....	G-17
G.4.6	Validate Carrier-in-Carrier Performance .....	G-18
G.5	Operational References .....	G-20
G.5.1	Calculate Carrier-in-Carrier Link Budget.....	G-20
G.5.2	Estimate PSD Ratio.....	G-21
G.5.2.1	Estimate PSD Ratio from LST .....	G-21
G.5.2.2	Estimate PSD Ratio from Satmaster.....	G-22
G.6	Carrier-in-Carrier Automatic Power Control (CnC-APC) .....	G-23
G.6.1	Overview.....	G-23
G.6.2	AUPC and Carrier-in-Carrier in the CDM-570A/AL.....	G-23
G.6.3	The CnC Automatic Power Control Algorithm.....	G-23
G.6.4	CnC-APC Framing .....	G-26
G.6.5	Solving the Problem of Self-Locking .....	G-26
G.6.6	CnC-APC Response Time .....	G-27

G.6.7	CnC-APC Setup .....	G-27
G.6.8	CnC-APC Redundancy Support Notes .....	G-32
G.7	DoubleTalk Carrier-in-Carrier Specifications.....	G-33
G.8	Carrier-in-Carrier Summary.....	G-34
G.9	Glossary.....	G-34
<b>APPENDIX H. <math>E_B/N_0</math> MEASUREMENT .....</b>		<b>H-1</b>
<b>APPENDIX I. RADIUS CLIENT .....</b>		<b>I-1</b>
I.1	Overview .....	I-1
I.1.1	RADIUS List of Supported RFCs (Requests for Comment) .....	I-1
I.2	Service Types.....	I-2
I.3	RADIUS Client.....	I-2
I.4	RADIUS Operation and Configuration.....	I-4
I.4.1	RADIUS M&C using the CDM-570A/570AL HTTP (Web Server) Interface .....	I-5
I.4.2	RADIUS M&C Using Telnet.....	I-6
<b>APPENDIX J. EDMAC CHANNEL .....</b>		<b>J-1</b>
J.1	Theory of Operation.....	J-1
J.1.1	EDMAC, EDMAC-2 .....	J-1
J.2	M&C Connection.....	J-2
J.3	Setup Summary.....	J-3
<b>APPENDIX K. GPS MODE .....</b>		<b>K-1</b>
K.1	Overview .....	K-1
K.2	Hardware Setup .....	K-1
K.3	Remote Commands.....	K-2
<b>APPENDIX L. ADVANCED QUALITY OF SERVICE (QOS) OPTION.....</b>		<b>L-1</b>
L.1	Overview .....	L-1
L.1.1	Max/Pri (Maximum Bandwidth/Priority) QoS Mode.....	L-2
L.1.1.1	Max/Pri QoS Mode Example .....	L-5
L.1.2	Min/Max (Minimum/Maximum Bandwidth) QoS Mode .....	L-5
L.1.2.1	Min/Max QoS Mode Example.....	L-6

L.1.3	DiffServ QoS Mode .....	L-8
L.1.3.1	DiffServ QoS Mode Example .....	L-9
L.1.4	VLAN – Priority/Max (VLAN-based Layer 2) QoS Mode.....	L-11
L.2	QoS with ACM (Adaptive Coding and Modulation) .....	L-12
L.2.1	Maximum Clipping.....	L-12
L.2.2	Minimum Data Rate .....	L-12
L.2.3	DiffServ w/ACM QoS Example .....	L-12
L.3	Glossary of Terms.....	L-13
L.4	QoS List of Supported RFCs (Requests for Comment) .....	L-14
<b>APPENDIX M. TRANSMIT SPECTRUM FILTERING OPTIONS .....</b>		<b>M-1</b>
M.1	Overview .....	M-1
M.2	Observations and Recommendations.....	M-1
<b>APPENDIX N. 1:1 IP REDUNDANCY .....</b>		<b>N-1</b>
N.1	Overview .....	N-1
N.2	Serial/Telnet CLI Operation Quick Reference .....	N-2
N.3	CRS-XXX 1:1 Redundancy Switch Functional Description .....	N-4
N.3.1	CRS-180 70/140 MHz 1:1 Redundancy Switch .....	N-4
N.3.2	CRS-170A L-Band 1:1 Redundancy Switch .....	N-4
N.4	CDM-570A/570AL-IP 1:1 IP Data Switching Functional Description.....	N-6
N.5	CDM-570A/570AL-IP 1:1 IP Redundancy Configuration .....	N-8
N.6	Cabling the CDM-570A-IP .....	N-10
N.7	Cabling the CDM/R-570AL-IP .....	N-11
<b>APPENDIX P. ADAPTIVE CODING AND MODULATION (ACM) OPTION.....</b>		<b>P-1</b>
P.1	Overview .....	P-1
P.2	Background .....	P-2
P.3	Requirements for ACM .....	P-3
P.4	An Existing Satellite ACM Scheme .....	P-7
P.5	Disadvantages of DVB-S2 .....	P-7

P.6	VersaFEC ACM (IP-ACM) .....	P-8
P.6.1	VersaFEC ACM Latency.....	P-8
P.6.2	Configuring VersaFEC ACM .....	P-10
P.6.3	Switch Points .....	P-11
P.7	Versa FEC-2 ACM (V2-ACM) .....	P-12
P.7.1	VersaFEC-2 ACM Latency .....	P-12
P.7.2	Configuring VersaFEC-2 ACM.....	P-13
P.8	Monitoring ACM Performance.....	P-16
P.9	Notes and Recommendations.....	P-16
P.10	Summary of Specifications.....	P-19
P.10.1	VersaFEC ACM.....	P-19
P.10.2	VersaFEC-2 ACM .....	P-20
<b>APPENDIX Q. DEDICATED MANAGEMENT PORT FEATURE .....</b>		<b>Q-1</b>
Q.1	Overview .....	Q-1
Q.2	Dedicated Management Port – Description .....	Q-2
Q.2.1	Configure Dedicated Management Port.....	Q-2
Q.3	Working Mode = Managed Switch Mode .....	Q-4
Q.3.1	Managed Switch Mode – Local ONLY Mode .....	Q-5
Q.3.2	Managed Switch Mode – Local & Remote Mode .....	Q-6
Q.4	Working Mode = Router Mode (Point-to-Multipoint / Point-to-Point / Vipersat) .....	Q-7
Q.4.1	Configure Router Mode.....	Q-7
Q.5	Dedicated Management Port and 1:1 Redundancy Operation .....	Q-10
Q.5.1	1:1 Redundancy in Managed Switch Mode.....	Q-10
Q.5.2	1:1 Redundancy in Router Mode.....	Q-11
<b>APPENDIX R. CARRIER ID (DVB-CID METACARRIER®).....</b>		<b>R-1</b>
R.1	Overview .....	R-1
R.2	About MetaCarrier .....	R-1
R.3	Functional Description .....	R-2
R.4	Configuring the CDM-570A/570AL for Carrier ID Operation .....	R-3
R.4.1	Enabling Carrier ID Operation.....	R-3
R.4.1.1	Enabling Operation via the CDM-570A/570AL Front Panel and VFD.....	R-3

# LIST OF TABLES

Table 1-1. Standard vs. FAST and FAST-accessible Hardware Options .....	1–12
Table 3-1. Rear Panel External Cabling Connections .....	3–5
Table 3-2. Data Interface Connector Pin Assignments.....	3–7
Table 3-3. Typical Ethernet Port Pin Assignments .....	3–8
Table 3-4. Balanced E1/T1 G.703 Connector Pin Assignments.....	3–9
Table 3-5. Remote Control Connector Pin Assignments .....	3–11
Table 3-6. Alarms Connector Pin Assignments .....	3–12
Table 3-7. 1:1 Control Connector Pin Assignments.....	3–12
Table 3-8. Console Port Async-Serial Connection Pin Assignments .....	3–13
Table B-1. Viterbi Decoding Summary.....	B–2
Table B-2. 8-PSK/TCM Coding Summary .....	B–4
Table B-3. The VersaFEC ModCod Set.....	B–7
Table B-4. Extended CCM Codes.....	B–8
Table B-5. ULL Codes.....	B–9
Table B-6. VersaFEC-2 ModCod Set – Long Block.....	B–11
Table B-7. VersaFEC-2 ModCod Set – Short Block.....	B–12
Table D-1. ALDC vs. LZS Compression Comparison.....	D–17
Table G-1. Spectral Efficiency using DoubleTalk Carrier-in-Carrier .....	G–7
Table L-1. 802.1q to Layer 2 QoS Priority Conversion .....	L–11
Table P-1. VersaFEC Implementation of ACM – 100 ksymbols/sec Example Case.....	P–8
Table P-2. VersaFEC-2 End-to-End Latency @ 100 kbps.....	P–12

# LIST OF FIGURES

Figure 1-1. CDM-570A and CDM-570AL Satellite Modems .....	1–1
Figure 1-2. Modem Dimensional Envelope (Shown w/Optional Packet Processor).....	1–5
Figure 1-3. Modem Front Panel View (CDM-570A Shown).....	1–6
Figure 1-4. Modem Rear Panel View (Shown w/Optional Packet Processor).....	1–7
Figure 2-1. Unpack and Inspect the Shipment.....	2–1
Figure 2-2. Install the Modem into a Rack Enclosure .....	2–3
Figure 2-3. Install the Optional Rear Support Brackets Kit .....	2–4
Figure 3-1. Coaxial Connector Examples .....	3–2
Figure 3-2. D-Subminiature Connector Examples .....	3–4
Figure 3-3. Modem Rear Panel (CDM-570AL-IP Shown).....	3–5
Figure 3-4. CN-0000268 DB-15M → RJ-48F Adapter for Balanced E1/T1 G.703 Operation .....	3–10
Figure 3-5. Modem Chassis Ground Interface (CDM-570AL-IP Shown).....	3–14
Figure 3-6. Modem Standard AC Chassis (CDM-570AL-IP Shown) .....	3–16
Figure 3-7. Apply AC Power to the Modem .....	3–17
Figure 3-8. Replace the AC Chassis Fuses.....	3–17
Figure 3-9. Modem Optional DC Chassis (CDM-570AL-IP shown).....	3–19
Figure 3-10. Apply Power to the Optional DC Chassis.....	3–19
Figure 3-11. Replace the Optional DC Chassis Fuses .....	3–20
Figure 3-12. CDMR-570AL Reduced Chassis Depth Modem -24 or -48V DC Power (CDMR-570AL-IP Shown).....	3–21
Figure 3-13. Apply DC Power to the CDMR-570AL.....	3–21
Figure 3-14. Replace the CDMR-570AL DC Power Fuse .....	3–22
Figure 5-1. CDM-570A HTTP Interface – Admin   FAST Page .....	5–4
Figure 6-1. Modem Front Panel Operation Features (CDM-570A shown) .....	6–1
Figure 6-2. CDM-570A/570AL Principle Menu Tree .....	6–6
Figure 6-3. Loopback Test Modes .....	6–57
Figure 7-1. CDM-570A HTTP Interface Menu Tree.....	7–11

Figure 7-2. CDM-570A/570AL Satellite Modem Home Page .....	7-13
Figure 7-3. Home   Contact Page .....	7-14
Figure 7-4. Home   Support Page .....	7-15
Figure 7-5. Admin   Access Page.....	7-16
Figure 7-6. Admin   SNMP Page.....	7-18
Figure 7-7. Admin   Working Mode Page.....	7-19
Figure 7-8. Admin   PaP Features Page .....	7-20
Figure 7-9. Admin   Firmware   Modem Page.....	7-22
Figure 7-10. Admin   Firmware   Packet Processor Page.....	7-23
Figure 7-11. Admin   FAST Page .....	7-24
Figure 7-12. Admin   RADIUS Page.....	7-25
Figure 7-13. Admin   PaP Save Page.....	7-26
Figure 7-14. Admin   Reboot Page .....	7-27
Figure 7-15. Configuration   Modem Page (Non-ACM Modes).....	7-28
Figure 7-16. Configuration   Modem   IP-ACM (VersaFEC ACM) Page .....	7-29
Figure 7-17. Configuration   Modem   VersaFEC-2-ACM (V2-ACM) Page.....	7-30
Figure 7-18. Configuration   LAN Page.....	7-33
Figure 7-19. Configuration   ARP Page .....	7-35
Figure 7-20. Configuration   Routing   Routes Page .....	7-37
Figure 7-21. Configuration   Routing   IGMP Page .....	7-38
Figure 7-22. Configuration   Routing   DHCP Page .....	7-40
Figure 7-23. Configuration   Managed Switch Page .....	7-41
Figure 7-24. Configuration   WAN   QoS Pages .....	7-43
Figure 7-25. Configuration   WAN   QoS Pages (cont.) .....	7-44
Figure 7-26. Configuration   WAN   QoS Pages (cont.) .....	7-45
Figure 7-27. Configuration   WAN   Compression Page .....	7-51
Figure 7-28. Configuration   WAN   HDLC Page.....	7-52
Figure 7-29. Configuration   Overhead Page.....	7-53
Figure 7-30. Configuration   Utilities   Utilities 1 Page.....	7-55
Figure 7-31. Configuration   Utilities   Carrier ID Page.....	7-59
Figure 7-32. Configuration   BUC Page .....	7-60
Figure 7-33. Configuration   LNB Page.....	7-60
Figure 7-34. Status   Modem Status Page (VersaFEC ACM (IP-ACM) or VersaFEC-2 ACM (V2-ACM) Mode Not Active).....	7-61
Figure 7-35. Status   Modem Status Page (VersaFEC ACM (IP-ACM) or VersaFEC-2 ACM (V2-ACM) Mode Active) .....	7-62
Figure 7-36. Status   System Logs   Modem Page .....	7-63
Figure 7-37. Status   Modem Info Page .....	7-65
Figure 7-38. Status   Traffic Statistics   Ethernet Page (upper section).....	7-66
Figure 7-39. Status   Traffic Statistics   Ethernet Page (lower section) .....	7-67
Figure 7-40. Status   Traffic Statistics   Router Page (upper section).....	7-68
Figure 7-41. Status   Traffic Statistics   Router Page (lower section) .....	7-69
Figure 7-42. Status   Traffic Statistics   WAN Page .....	7-70
Figure 7-43. Status   Traffic Statistics   Compression Page .....	7-71
Figure 7-44. Status   Traffic Statistics   QoS Page .....	7-72
Figure 7-45. Status   Traffic Statistics   Clear Counter Page .....	7-73
Figure 7-46. Status   Performance Page .....	7-73
Figure 7-47. Status   Graph   Constellation Page .....	7-74
Figure 7-48. Status   Graphs   Spectrum Page.....	7-75
Figure 7-49. ODU Page Examples (Enable, Config, Status, and Utilities) .....	7-76
Figure 7-50. Redundancy Page .....	7-77
Figure 9-1. Login Using the Windows Telnet Client Program.....	9-4
Figure 9-2. Main Menu .....	9-7
Figure 9-3. Administration .....	9-8
Figure 9-4. Name/Password Configuration.....	9-9
Figure 9-5. Access Lists.....	9-10

Figure 9-6. Feature Configuration .....	9-11
Figure 9-7. RADIUS Configuration .....	9-14
Figure 9-8. 3xDES Configuration .....	9-15
Figure 9-9. SNMP Configuration .....	9-15
Figure 9-10. Interface Configuration .....	9-19
Figure 9-11. Ethernet Interface in Managed Switch Mode .....	9-20
Figure 9-12. VLAN Table .....	9-22
Figure 9-13. Ethernet Interface in Router Mode .....	9-23
Figure 9-14. Satellite/HDLC Interface .....	9-25
Figure 9-15. Receive HDLC Channel Addresses .....	9-25
Figure 9-16. QoS Configuration .....	9-26
Figure 9-17. QoS Rules Configuration (Max/Priority Mode) .....	9-27
Figure 9-18. QoS Rules Configuration (Min/Max Mode) .....	9-29
Figure 9-19. DiffServ Rules Configuration .....	9-30
Figure 9-20. Assured Forwarding Rules .....	9-30
Figure 9-21. Route Table Configuration .....	9-31
Figure 9-22. Route Table Configuration   Per Route .....	9-33
Figure 9-23. Protocol Configuration .....	9-34
Figure 9-24. IGMP Information .....	9-34
Figure 9-25. ARP Table Utilities .....	9-37
Figure 9-26. Brouter Configuration .....	9-38
Figure 9-27. Vipersat Configuration .....	9-40
Figure 9-28. Modem Parameters .....	9-41
Figure 9-29. Modem Configuration .....	9-41
Figure 9-30. Tx (Transmit Modem) Configuration .....	9-42
Figure 9-31. Rx (Receive Modem) Configuration .....	9-46
Figure 9-32. Framing Mode Configuration .....	9-49
Figure 9-33. Data Interface Configuration .....	9-50
Figure 9-34. Reference Configuration .....	9-50
Figure 9-35. Alarm Mask Configuration .....	9-51
Figure 9-36. BUC (Block Up Converter) Configuration .....	9-52
Figure 9-37. LNB (Low Noise Block Converter) Configuration .....	9-53
Figure 9-38. CnC Configuration .....	9-54
Figure 9-39. BERT (Bit Error Rate Test) Configuration .....	9-55
Figure 9-40. Monitor .....	9-56
Figure 9-41. Stored Events .....	9-57
Figure 9-42. Link Statistics .....	9-58
Figure 9-43. BUC Status .....	9-59
Figure 9-44. LNB Monitor (Per LNB) .....	9-59
Figure 9-45. CnC Monitor .....	9-60
Figure 9-46. Satellite Modem Information .....	9-60
Figure 9-47. Satellite Modem > Utilities .....	9-61
Figure 9-48. Carrier ID Configuration .....	9-62
Figure 9-49. 1:1 Redundancy Configuration .....	9-63
Figure 9-50. Operations and Maintenance .....	9-64
Figure 9-51. Unit Information .....	9-66
Figure 9-52. Statistics Menu .....	9-67
Figure 9-53. IP Routing Statistics .....	9-69
Figure 9-54. Filter/Drop Statistics .....	9-70
Figure 9-55. QoS Statistics .....	9-73
Figure 9-56. Ethernet Statistics – Initial Page .....	9-74
Figure 9-57. Ethernet Statistics – Expanded Page .....	9-75
Figure 9-58. WAN Statistics .....	9-76
Figure 9-59. Compression Statistics .....	9-78
Figure 9-60. CPU Statistics .....	9-79
Figure 9-61. VLAN Statistics .....	9-79



Figure 9-62. Active Flow Statistics .....	9-80
Figure 9-63. Event Log.....	9-80
Figure 9-64. Event Log – View Log.....	9-81
Figure 9-65. Database Operations.....	9-83
Figure 9-66. Diagnostics .....	9-84
Figure 10-1. CDM-570A/570AL Front Panel Features .....	10-2
Figure 10-2. CDM-570A Menu Tree – ODU Operation .....	10-5
Figure 10-3. ODU: CSAT-5060 Transceiver Menu Tree .....	10-7
Figure 10-4. ODU: KST-2000A/B Transceiver Menu Tree .....	10-17
Figure 10-5. CDM-570A HTTP Interface – ODU CSAT/KST Transceiver Menu Tree .....	10-25
Figure 10-6. ODU   Config Page (CSAT-5060).....	10-26
Figure 10-7. ODU   Config Page (CSAT-5060).....	10-27
Figure 10-8. ODU   Config Page (KST-2000A/B) .....	10-29
Figure 10-9. ODU   Status Page (CSAT-5060).....	10-30
Figure 10-10. ODU   Status Page (KST-2000A/B).....	10-31
Figure 10-11. ODU   Utilities Page (CSAT-5060) .....	10-32
Figure 10-12. ODU   Utilities Page (KST-2000A/B) .....	10-34
Figure 10-13. CDM/R-570AL Menu Tree – ODU Operation.....	10-37
Figure 10-14. CDM-570A HTTP Interface – ODU BUC/LNB Menu Tree .....	10-45
Figure 10-15. Configuration   BUC Page .....	10-46
Figure 10-16. Configuration   LNB Page.....	10-47
Figure A-1. EIA-530 to EIA-422/449 DCE Conversion Cable (CEFD P/N CA/WR12753-1) .....	A-2
Figure A-2. EIA-530 to V.35 DCE Conversion Cable (CEFD P/N CA/WR12685-1).....	A-3
Figure B-1. VersaFEC Codes versus Shannon Capacity .....	B-8
Figure B-2. VersaFEC-2 Codes vs. Constrained Capacity (Typical Values Shown).....	B-13
Figure B-3. Viterbi Decoding.....	B-21
Figure B-4. Viterbi with Concatenated RS 220, 200 Outer Code .....	B-22
Figure B-5. 8-PSK/TCM Rate 2/3 Decoding with/without Concatenated RS 219, 201 Outer Code.....	B-23
Figure B-6. 16-QAM Rates 3/4 and 7/8 with Concatenated RS 220,200 Outer Code.....	B-24
Figure B-7. Turbo Product Code Rate 5/16 BPSK .....	B-25
Figure B-8. Turbo Product Code Rate 21/44 BPSK/QPSK/OQPSK.....	B-26
Figure B-9. Turbo Product Code Rate 3/4 QPSK/OQPSK, 8-PSK/8-QAM, and 16-QAM.....	B-27
Figure B-10. Turbo Product Code Rate 7/8 QPSK/OQPSK, 8-PSK/8-QAM, and 16-QAM.....	B-28
Figure B-11. Turbo Product Code Rate 0.95 QPSK/OQPSK and 8-PSK/Q-QAM.....	B-29
Figure B-12. VersaFEC Code Rate 0.488 BPSK.....	B-30
Figure B-13. VersaFEC Code Rates 0.533, 0.631, 0.706, and 0.803 QPSK .....	B-31
Figure B-14. VersaFEC Code Rates 0.642, 0.711, and 0.780 8-QAM .....	B-32
Figure B-15. VersaFEC Code Rates 0.731, 0.780, 0.829, and 0.853 16-QAM .....	B-33
Figure B-16. VersaFEC Code Extended CCM Rate 0.576 8-QAM and Rate 0.644 16-QAM .....	B-34
Figure B-17. ULL Code Rate 0.493 BPSK/QPSK and Rates 0.654 and 0.734 QPSK .....	B-35
Figure B-18. VersaFEC-2 Long Block.....	B-37
Figure B-19. VersaFEC-2 Short Block.....	B-38
Figure B-20. Differential Encoding – No FEC, No Scrambling .....	B-39
Figure D-1. CDM-570A/570AL-IP Telnet Interfaces (Serial Remote / CLI) .....	D-20
Figure D-2. CDM-570A HTTP (Web Server) Interface Home Page .....	D-21
Figure D-3. Managed Switch Point-to-Point System Configuration .....	D-26
Figure D-4. Router Mode Point-to-Point System Configuration.....	D-27
Figure D-5. Managed Switch Mode .....	D-36
Figure D-6. Router Point-to-Point Working Mode .....	D-37
Figure D-7. Router Point-to-MultiPoint Working Mode w/HDLC .....	D-38
Figure D-8. Brouter Point-to-MultiPoint Working Mode w/VLAN Filtering .....	D-41
Figure F-1. TX Clock Modes .....	F-3
Figure F-2. RX Clock Modes.....	F-5
Figure F-3. G.703 Clock Extension Mode 1 .....	F-9
Figure F-4. G.703 Clock Extension Mode 2.....	F-10
Figure F-5. G.703 Clock Extension Mode 3.....	F-11

Figure G-1. Conceptual Block Diagram ..... G-3

Figure G-2. Conventional FDMA Link ..... G-5

Figure G-3. Same Link Using CDM-570A with DoubleTalk Carrier-in-Carrier ..... G-6

Figure G-4. Duplex Link Optimization ..... G-6

Figure G-5. DoubleTalk Carrier-in-Carrier Signals..... G-8

Figure G-6. Carrier-in-Carrier Signal Processing Block Diagram ..... G-9

Figure I-1. RADIUS Authentication Process ..... I-2

Figure I-2. CDM-570A/570AL HTTP (Web Server) Interface Admin | RADIUS Page ..... I-5

Figure L-1. IEEE 802.1q VLAN Priority ..... L-11

Figure N-1. Serial/Telnet CLI Main Menu ..... N-2

Figure N-2. CDM-570A/570AL-IP 1:1 IP Redundancy Example (Router Mode Shown, Modem 'A' Online)  
..... N-6

Figure N-3. CDM-570A/570AL-IP 1:1 IP Redundancy Switchover Example (Router Mode Shown, Modem  
'B' Online)..... N-7

Figure N-4. CDM-570A-IP and CRS-180 Interconnect..... N-10

Figure N-5. CDM/R-570AL-IP and CRS-170A Interconnect..... N-11

Figure P-1. ACM-over-Satellite – Generic Example ..... P-5

Figure P-2. CDM-570A/570AL-IP ACM ModCod Switch Points ..... P-11

Figure Q-1. CDM-570A/570AL Advanced Satellite Modem..... Q-1

Figure Q-2. CDM-570A/570AL Dedicated Management Port Operation..... Q-2

Figure Q-3. CDM-570A/570AL Dedicated Management Port Configuration ..... Q-3

Figure Q-4. CDM-570A/570AL Working Mode Configuration..... Q-4

Figure Q-5. CDM-570A/570AL Operation – Local ONLY Mode ..... Q-5

Figure Q-6. CDM-570A/570AL Operation – Local & Remote Mode ..... Q-6

Figure Q-7. CDM-570A/570AL Router Mode IP Addresses ..... Q-7

Figure Q-8. CDM-570A/570AL Router Mode – Assign IP Addresses ..... Q-8

Figure Q-9. CDM-570A/570AL Route Tables ..... Q-9

Figure Q-10. CDM-570A/570AL 1:1 Redundancy Operation ..... Q-10

Figure Q-11. 1:1 Redundancy Configuration in Managed Switch Mode ..... Q-10

### Acronym List

Acronym	Description
ACM	Adaptive Coding and Modulation
AFD	Assured Forwarding Rules
AGC	Automatic Gain Control
APC	Automatic Power Control
ARP	Address Resolution Protocol
ASFD	Assured Forwarding
AUPC	Automatic Uplink Power Control
AWG	American Wire Gauge
BERT	Bit Error Rate Test
BUC	Block Up Converter
BW	Bandwidth
CAPEX	Capital Expenditure
CCM	Constant Coding and Modulation
CLI	Command Line Interface
CMOS	Complementary Metal Oxide Semiconductor
CnC	Carrier-in-Carrier
CnC-APC	Carrier-in-Carrier Automatic Power Control
CR	Carriage Return
CTRX	CITRIX Protocol
DCE	Data Circuit-termination Equipment
DHCP	Dynamic Host Configuration Protocol
DSCP	Differentiated Services Code Point
DTE	Data Terminal Equipment
DVB	Digital Video Broadcast
DVB-CID	Digital Video Broadcast Carrier Identification or "MetaCarrier"
EDMAC	Embedded Distant-end Monitor and Control
EIA	Electronic Industries Association

Acronym	Description
EMC	Electro Magnetic Compatibility
ERM	Electromagnetic Compatibility and Radio Spectrum Matters
ESA	EDMAC Slave Address
ESD	Electrostatic Discharge
FAST	Fully Accessible System Topology
FEC	Forward Error Correction
FIFO	First In First Out
FPGA	Field-programmable Gate Array
FPL	Front Panel Lockout
FSK	Frequency Shift Keying
FTP	File Transfer Protocol
GPS	Global Positioning System
HDLC	High-level Data Link Control
HTTP	Hypertext Transfer Protocol
ICMP	Internet Control Message Protocol
IEC	International Electrotechnical Commission
IGMP	Internet Group Management Protocol
IP	Internet Protocol
IPA	IP Address
LDPC	Low Density Parity Check Coding
LED	Light Emitting Diode
LF	Line Feed
LNB	Low-noise Block Down Converter
LO	Local Oscillator
LRS	Local Remote Status
LVD	Low Voltage Directive
M&C	Monitor and Control
MIB	Management Information Base

Acronym	Description
MLC	Management Link Configuration
N-IP	Non-Internet Protocol
NMS	Network Management System
ODU	Out Door Unit
OID	Object Identifier
OPEX	Operating Expenses
OQPSK	Offset Quadrature Phase Shift Key
ORCL	ORACLE Protocol
OXCO	Oven-Controlled Crystal Oscillator
PARAM	Parameters
PCB	Printed Circuit Board
PEB	Power Equivalent Bandwidth
PHP	Per Hop Behavior
PSD	Power Spectral Density
QEF	Quasi Error Free
QOS	Quality of Service
QPSK	Quadrature Phase Shift Key
R&TTE	Radio and Telecommunications Terminal Equipment
RADIUS	Remote Authentication Dial In User Service
RD	Receive Data
RFC	Request for Comment
RISC	Reduced Instruction Set Computing
RoHS	Restriction of Hazardous Substances
RS	Recommended Standard
R-S	Reed Solomon
RSL	Receive Signal Level
RT	Receive Timing
RTP	Real Time Protocol

Acronym	Description
RTPS	Real Time Protocol Signaling
SAP	Service Announcement Protocol
SAR	Segmentation and Reassembly
SatMac	Satellite System Monitor and Control
SAW	Surface Acoustic Wave
SD	Send Data
SE	Spectral Efficiency
SMTP	Simple Mail Transfer Protocol
SNMP	Simple Network Management Protocol
SNR	Signal to Noise Ratio
SQL	Structured Query Language
ST	Send Timing
TCC	Turbo Convolution Codes
TCM	Trellis Coding Modulation
TCP	Transmission Control Protocol
TELNET	Telnet Protocol
TOS	Type of Service
TPC	Turbo Product Code
TT	Terminal Timing
UART	Universal Asynchronous Receiver Transmitter
UDP	User Datagram Protocol
UHF	Ultra High Frequency
ULL	Ultra Low Latency
VDEO	Video Real Time Protocol
VFD	Vacuum Fluorescent Display
VLAN	Virtual Local Area Network
VMS	Vipersat Management System
WAN	Wide Area Network

Acronym	Description
WRED	Weighted Random Early Detection

BLANK PAGE



# PREFACE

---

## About this Manual

This manual provides installation and operation information for the Comtech EF Data CDM-570AL, CDMR-570AL, and CDM-570A Satellite Modems with or without the optional High-Performance Packet Processor. These modems are essentially identical in their operation, with these differences:

- The L-Band unit, available in standard (CDM-570AL) and reduced chassis depth (CDMR-570AL) versions, includes support for externally connected Block Up Converters (BUCs) and Low-Noise Block Down Converters (LNBs).
- The CDM-570A 70/140MHz IF band unit includes support for externally connected Comtech EF Data Transceivers (CSAT-5060, KST-2000A/B);



**Unless otherwise specified, these products are referred to collectively throughout this manual as “the modem”. When equipped with the optional High-Performance Packet Processor, the modem may also be referred to as the CDM-570A-IP, CDM-570AL-IP, CDM-570A/570AL-IP, or simply the CDM-IP.**

This is an informational document intended for the persons responsible for the operation and maintenance of the modem.

## Conventions and References

### Patents and Trademarks

See all of Comtech EF Data's Patents and Patents Pending at <http://patents.comtechefdata.com>. Comtech EF Data acknowledges that all trademarks are the property of the trademark owners.

- DoubleTalk® is licensed from “Raytheon Applied Signal Technology”.
- DoubleTalk® is a registered trademark of “Raytheon Applied Signal Technology”.
- Carrier-in-Carrier® is a registered trademark of Comtech EF Data.

### Warnings, Cautions, and Notes



A **WARNING** GIVES INFORMATION ABOUT A POSSIBLE HAZARD THAT MAY CAUSE DEATH OR SERIOUS INJURY.



A **CAUTION** gives information about a possible hazard that MAY CAUSE INJURY or PROPERTY DAMAGE.



A **NOTE** gives important information about a task or the equipment.



A **REFERENCE** directs you to additional information about a task or the equipment.

### Examples of Multi-Hazard Notices

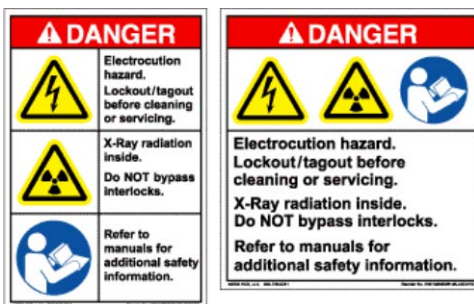

### Recommended Standard Designations

The Electronic Industries Association (EIA) designations supersede the Recommended Standard (RS) designations. References to the old designations may be shown when depicting actual text (e.g., RS-232) displayed on Web Server pages, serial remote interfaces, Telnet Command Line Interfaces (CLIs), or unit rear panels. All other references in the manual refer to EIA designations.



**CAUTION – YOU SHOULD CAREFULLY REVIEW THE FOLLOWING INFORMATION.**

---

## Safety and Compliance

### Electrical Safety and Compliance

The unit complies with the **EN 60950 Safety of Information Technology Equipment (Including Electrical Business Machines)** safety standard.



**CAUTION – IF THE MODEM IS OPERATED IN A VEHICLE OR MOVABLE INSTALLATION, MAKE SURE THE UNIT IS STABLE. OTHERWISE, EN 60950 SAFETY IS NOT GUARANTEED.**



**Sect. 3.3 Ground and Power Connections**

### Electrical Installation



**CAUTION – CONNECT THE MODEM TO A POWER SYSTEM THAT HAS SEPARATE GROUND, LINE AND NEUTRAL CONDUCTORS. DO NOT CONNECT THE UNIT WITHOUT A DIRECT CONNECTION TO GROUND.**

The modem is rated for operation over the range 100 to 240 volts AC. It has a maximum power consumption of 250 Watts (when equipped with a 150W BUC power supply), and draws a maximum of 2.5 Amps.

The installation and connection to the line supply must be made in compliance to local or national wiring codes and regulations.

The unit is shipped with a line inlet cable suitable for use in the country of operation. If it is necessary to replace this cable, ensure the replacement has an equivalent specification. Examples of acceptable ratings for the cable include HAR, BASEC and HOXXX-X. Examples of acceptable connector ratings include VDE, NF-USE, UL, CSA, OVE, CEBEC, NEMKO, DEMKO, BS1636A, BSI, SETI, IMQ, KEMA-KEUR and SEV.

### Fuses



**CAUTION – FOR CONTINUED OPERATOR SAFETY, ALWAYS REPLACE THE FUSES WITH THE CORRECT TYPE AND RATING.**

The 115/230 volt AC-powered modem is fitted with two 20mm T3.15A (P/N 3.15ASB-IEC) Slo-Blo fuses – one each for line and neutral connections. They are contained within a fuse holder that is press-fit into the body of the IEC power module.

**Optional -48V DC Units:** These units are fitted with two 20mm Slo-Blo fuses – one each for positive and negative connections. They are contained within a fuse holder that is press-fit into the body of the IEC power module.

- For 42 to 60 volt DC operation, use T5.0A fuses if the modem has no BUC power supply.
- For 42 to 60 volt DC operation, use T8.0A fuses if the modem is fitted with an internal BUC power supply.

**Optional -24V DC Units:** The 24 volt DC-powered modems are fitted with two 20mm Slo-Blo fuses – one each for positive and negative connections. They are contained within a fuse holder that is press-fit into the body of the IEC power module.

- For 20 to 36 volt DC operation, use a T5.0A fuse if the modem has no BUC power supply.
- For 20 to 36 volt DC operation, use a T6.3A fuse if the modem is fitted with an internal BUC power supply.

**CDMR-570AL Reduced Chassis Depth -48V or -24V DC L-Band units:** This unit is fitted with one Type TR5 Slo-Blo fuse contained within a screw-in receptacle located to the left of the terminal block.

- For 42 to 60 volt DC operation, use TR5 6.3A fuses if the modem has no BUC power supply.

## Grounding



**CAUTION – CORRECT GROUNDING PROTECTION IS REQUIRED TO PREVENT PERSONAL INJURY AND EQUIPMENT DAMAGE.**

**THIS MODEM IS DESIGNED FOR CONNECTION TO A POWER SYSTEM THAT HAS SEPARATE GROUND, LINE, AND NEUTRAL CONDUCTORS. THE EQUIPMENT IS NOT DESIGNED FOR CONNECTION TO A POWER SYSTEM THAT HAS NO DIRECT CONNECTION TO GROUND. IT IS THEREFORE IMPERATIVE DURING INSTALLATION, CONFIGURATION, AND OPERATION THAT YOU PROPERLY GROUND THE MODEM USING THE GROUND STUD PROVIDED ON THE MODEM REAR PANEL AND THAT THE MODEM IS ALWAYS CONNECTED TO THE PROTECTIVE EARTH.**

- **IN FINLAND: "LAITE ON LIITETTÄVÄ SUOJAMAADOITUSKOSKETTIMILLA VARUSTETTUUN PISTORASIAAN."**
- **IN NORWAY: "APPARATET MÅ TILKOPLES JORDET STIKKONTAKT."**
- **IN SWEDEN: "APPARATEN SKALL ANSLUTAS TILL JORDAT UTTAG."**

## Operating Environment



**CAUTION – DO NOT OPERATE THE UNIT IN ANY OF THESE EXTREME OPERATING CONDITIONS:**

- **AMBIENT TEMPERATURES LESS THAN 0°C (32°F) OR MORE THAN 50°C (122°F). (MAXIMUM STORAGE TEMPERATURE ALLOWED IS -25°C (-13°F) TO 85°C (185°F)).**
- **PRECIPITATION, CONDENSATION, OR HUMID ATMOSPHERES OF MORE THAN 95% RELATIVE HUMIDITY.**
- **UNPRESSURIZED ALTITUDES OF MORE THAN 2000 METRES (6561.7 FEET) ABOVE MEAN SEA LEVEL (AMSL).**
- **EXCESSIVE DUST.**
- **FLAMMABLE GASES OR EXPLOSIVE ATMOSPHERES.**
- **CORROSIVE ENVIRONMENTS (INCLUDING SALT SPRAY) – ALL EXTERNAL CHASSIS HARDWARE MUST MEET CORROSION-RESISTENT SPECIFICATIONS OF RTCA/ DO-160G (ENVIRONMENTAL CONDITIONS AND TEST PROCEDURES FOR AIRBORNE EQUIPMENT), CATEGORY 'S' – SPECIFICALLY:**

Hardware Type	Material	Plating
Lockwasher	Phosphor Bronze	Electroless Nickel
Nut	Brass	

## European Union Radio Equipment and Telecommunications Terminal Equipment (R&TTE) Directive (1999/5/EC) and EN 301 489-1

Independent testing verifies that the modem complies with the European Union R&TTE Directive, its reference to EN 301 489-1 (*Electromagnetic compatibility and Radio spectrum Matters [ERM]; ElectroMagnetic Compatibility [EMC] standard for radio equipment and services, Part 1: Common technical requirements*), and the Declarations of Conformity for the applicable directives, standards, and practices that follow:

---

### European Union Electromagnetic Compatibility (EMC) Directive (2004/108/EC)

- **Emissions: EN 55022 Class B** – Limits and Methods of Measurement of Radio Interference Characteristics of Information Technology Equipment.
- **Immunity: EN 55024** – Information Technology Equipment: Immunity Characteristics, Limits, and Methods of Measurement.
- **EN 61000-3-2** – Harmonic Currents Emission
- **EN 61000-3-3** – Voltage Fluctuations and Flicker.

- **Federal Communications Commission Federal Code of Regulation FCC Part 15, Subpart B.**







**CAUTION – TO ENSURE THAT THE MODEM COMPLIES WITH THESE STANDARDS, OBEY THESE INSTRUCTIONS:**

- Use coaxial cable that is of good quality (e.g., RG58/U (50Ω) or RG59/U (75Ω)) for connections to the IF Tx and Rx (transmit and receive) BNC female connectors.
- Use Type 'D' connectors that have back-shells with continuous metallic shielding. Type 'D' cabling must have a continuous outer shield (either foil or braid, or both). The shield must be bonded to the back-shell.
- Operate the modem with its cover on at all times.

---

### European Union Low Voltage Directive (LVD) (2006/95/EC)

Symbol	Description
<HAR>	Type of power cord required for use in the European Community.
	<b>CAUTION: Double-pole/Neutral Fusing</b> <b>ACHTUNG: Zweipolige bzw. Neutraleiter-Sicherung</b>

International Symbols			
Symbol	Definition	Symbol	Definition
	Alternating Current		Protective Earth
	Fuse		Chassis Ground



**For additional symbols, refer to Warnings, Cautions and Notes listed earlier in this Preface.**

---

### European Union RoHS Directive (2002/95/EC)

This unit satisfies (with exemptions) the requirements specified in the European Union Directive on the Restriction of Hazardous Substances in Electrical and Electronic Equipment (EU RoHS, Directive 2002/95/EC).

---

### European Union Telecommunications Terminal Equipment Directive (91/263/EEC)

In accordance with the European Union Telecommunications Terminal Equipment Directive 91/263/EEC, do not directly connect the modem to the Public Telecommunications Network.

### CE Mark

Comtech EF Data declares that the modem meets the necessary requirements for the CE Mark.

---

## Product Support

For all product support, please call:

+1.240.243.1880

+1.866.472.3963 (toll free USA)

---

## Comtech EF Data Headquarters

<http://www.comtechefdata.com>

Comtech EF Data Corp.

2114 West 7th Street

Tempe, Arizona USA 85281

+1.480.333.2200

---

## Warranty Policy

Comtech EF Data products are warranted against defects in material and workmanship for a specific period from the date of shipment, and this period varies by product. In most cases, the warranty period is two years. During the warranty period, Comtech EF Data will, at its option, repair or replace products that prove to be defective. Repairs are warranted for the remainder of the original warranty or a 90 day extended warranty, whichever is longer. Contact Comtech EF Data for the warranty period specific to the product purchased.

For equipment under warranty, the owner is responsible for freight to Comtech EF Data and all related customs, taxes, tariffs, insurance, etc. Comtech EF Data is responsible for the freight charges only for return of the equipment from the factory to the owner. Comtech EF Data will return the equipment by the same method (i.e., Air, Express, Surface) as the equipment was sent to Comtech EF Data.

All equipment returned for warranty repair must have a valid RMA number issued prior to return and be marked clearly on the return packaging. Comtech EF Data strongly recommends all equipment be returned in its original packaging.

Comtech EF Data Corporation's obligations under this warranty are limited to repair or replacement of failed parts, and the return shipment to the buyer of the repaired or replaced parts.

## Limitations of Warranty

The warranty does not apply to any part of a product that has been installed, altered, repaired, or misused in any way that, in the opinion of Comtech EF Data Corporation, would affect the reliability or detracts from the performance of any part of the product, or is damaged as the result of use in a way or with equipment that had not been previously approved by Comtech EF Data Corporation.

The warranty does not apply to any product or parts thereof where the serial number or the serial number of any of its parts has been altered, defaced, or removed.

The warranty does not cover damage or loss incurred in transportation of the product.

The warranty does not cover replacement or repair necessitated by loss or damage from any cause beyond the control of Comtech EF Data Corporation, such as lightning or other natural and weather related events or wartime environments.

The warranty does not cover any labor involved in the removal and or reinstallation of warranted equipment or parts on site, or any labor required to diagnose the necessity for repair or replacement.

The warranty excludes any responsibility by Comtech EF Data Corporation for incidental or consequential damages arising from the use of the equipment or products, or for any inability to use them either separate from or in combination with any other equipment or products.

A fixed charge established for each product will be imposed for all equipment returned for warranty repair where Comtech EF Data Corporation cannot identify the cause of the reported failure.

## **Exclusive Remedies**

Comtech EF Data Corporation's warranty, as stated is in lieu of all other warranties, expressed, implied, or statutory, including those of merchantability and fitness for a particular purpose. The buyer shall pass on to any purchaser, lessee, or other user of Comtech EF Data Corporation's products, the aforementioned warranty, and shall indemnify and hold harmless Comtech EF Data Corporation from any claims or liability of such purchaser, lessee, or user based upon allegations that the buyer, its agents, or employees have made additional warranties or representations as to product preference or use.

The remedies provided herein are the buyer's sole and exclusive remedies. Comtech EF Data shall not be liable for any direct, indirect, special, incidental, or consequential damages, whether based on contract, tort, or any other legal theory.



# Chapter 1. INTRODUCTION

## 1.1 Overview



Unless otherwise specified, these products are collectively referred to throughout this manual as “the modem”. When equipped with the optional High-Performance Packet Processor, the modem may also be referred to as the CDM-570A-IP, CDM-570AL-IP, CDMR-570AL-IP, or simply the CDM-IP.



**Figure 1-1. CDM-570A and CDM-570AL Satellite Modems**

Comtech EF Data's CDM-570AL and CDMR-570AL Satellite Modems are intended for L-Band closed network applications. The CDM-570A Satellite Modem is the 70/140 MHz version of the same modem. Either frequency version serves as a drop-in replacement for the CDM-570L/CDMR-570L (L-Band) or CDM-570 (70/140 MHz) Satellite Modems. **Apart from the IF frequency band, the modems are essentially identical.** The modem is 100% backwards compatible with its predecessors, but incorporates new features and expansion capabilities.

### 1.1.1 Modem Features Overview

- The **CDM-570AL** provides an L-Band IF frequency range from 950 to 2250 MHz.
- The **CDM-570A** provides a 70/140 MHz IF frequency range from 50 to 90 MHz and 100 to 180 MHz.
- The **CDM-570AL** consumes only 29 Watts (typical, without any option cards).

- The **CDM-570A/570AL** may be equipped with the optional High-Performance Packet Processor card for 10/100 BaseT Ethernet operation that, in addition to providing Layers 3-5 functionality, incorporates a number of key features for Wide Area Network (WAN) bandwidth optimization: very low overhead High-level Data Link Control (HDLC); Header and Payload Compression; Advanced Quality of Service (QoS); and Triple DES (3XDES) Encryption.
- The **CDM-570A/570AL** offers variable data rates from 2.4 kbps to 10.239 Mbps, in BPSK, QPSK, Offset QPSK, 8-PSK, 8-QAM, 16-QAM modes.
- The **CDM-570A/570AL** supports an entirely new family of waveforms - VersaFEC-2<sup>®</sup> (both short and long block Low-density Parity Check Coding (LDPC)) with variable data rates in BPSK, QPSK, 8-ARY, 16-ARY, and 32-ARY modes.
- The **CDM-570A/570AL** provides, as Forward Error Correction (FEC) options: Viterbi, concatenated Reed-Solomon (R-S), Trellis Coded Modulation (TCM), Turbo Product Coding (TPC, IESS-315 compliant), ULL (Ultra Low Latency), VersaFEC<sup>®</sup> (a short-block, low latency LDPC), and VersaFEC-2.
- The **CDM-570A/570AL** provides a full range of built-in interface types, including G.703 T1 and E1 and, when the modem is equipped with the optional Packet Processor, Ethernet.
- The **CDM-570A/570AL** is compact – it is 1RU high, with a depth of 16 inches for the CDM-570AL, 11 inches for the CDMR-570AL Reduced Chassis Depth unit, and 13.13 inches for the CDM-570A.
- The **CDM-570A/570AL** features a front panel Vacuum Fluorescent Display (VFD), and six-button keypad for local Monitor and Control (M&C).
- The **CDM-570A/570AL** features an integrated 10/100 BaseT Ethernet interface for network-based remote product M&C – including SNMP, HTTP (non-secure Web server), and Telnet.
- The **CDM-570AL** supports external Block Up Converters (BUCs) and Low-noise Block Down Converters (LNBs). An optional BUC power supply, either 90 Watts or 150 Watts @ 50°C, may be installed internally. 10 MHz reference signals are available to drive both BUC and LNB. LNB power and Frequency Shift Keying (FSK) for 'smart' BUCs is standard.

## 1.1.2 Functional Description

The modem has two fundamentally different types of interface – IF and data:

- The IF interface provides a bidirectional link with the satellite via the uplink and downlink equipment.
- The data interface is a bidirectional path that connects the modem (assumed to be the Data Circuit-terminating Equipment (DCE)) to the customer's equipment (assumed to be the Data Terminal Equipment (DTE)).

Transmit data is received by the terrestrial interface where line receivers convert the clock and data signals to CMOS levels for further processing. A small First In First Out (FIFO) follows the terrestrial interface to facilitate the various clocking and framing options. If framing is enabled, the transmit clock and data output from the FIFO pass through the framer, where the Embedded Distant-end Monitor and Control (EDMAC) overhead data is added to the main data; otherwise, the clock and data are passed directly to the FEC encoder.

In the FEC encoder, the data is differentially encoded, scrambled, and then convolutionally encoded. Following the encoder, the data is fed to the transmit digital filters, which perform spectral shaping on the data signals. The resultant I and Q signals are then fed to the BPSK, QPSK/OQPSK, 8-PSK, or 16-QAM modulator. The carrier is generated by a frequency synthesizer, and the I and Q signals directly modulate this carrier to produce an IF output signal.

In both L-Band and 70/140 MHz operation, receive signals are first converted to a Ultra High Frequency (UHF) for Surface Acoustic Wave (SAW) filtering, and are then down converted to a lower IF frequency for direct sampling in a high speed A/D converter. An Automatic Gain Control (AGC) circuit controls the signal level presented to the A/D converter. Digital signal processing performs the final quadrature conversion to baseband followed by Nyquist filtering, carrier recovery, and symbol timing recovery. The resultant demodulated signal is fed, in soft decision form, to the selected FEC decoder (which can be Viterbi, TCM, Reed-Solomon, Turbo, VersaFEC, or VersaFEC-2, if installed).

After decoding, the recovered clock and data pass to the de-framer (if EDMAC framing is enabled) where the overhead information is removed. Following this, the data either passes or bypasses the Plesiochronous/Doppler buffer, which has a programmable size. From here, the receive clock and data signals are routed to the terrestrial interface, and are passed to the externally connected DTE equipment.

The modem signal processing functions are performed in a single, large Field-Programmable Gate Array (FPGA), which permits rapid implementation of changes, additions and enhancements in the field. These signal processing functions are controlled and monitored by a 32-bit Reduced Instruction Set Computing (RISC) microprocessor, which also controls all front panel, serial and Ethernet interfaces.

---

## 1.2 Features

### 1.2.1 Physical Description

The modem is constructed as a 1RU-high rack-mounting chassis, which can be free-standing if desired. Rack handles at the front facilitate removal from and placement into a rack. Physically, the modem is comprised of a single Printed Circuit Board (PCB) assembly with three expansion slots: one dedicated to Carrier-in-Carrier (CnC), and two others for FEC codecs and other option cards.

---

#### 1.2.1.1 Standard Assemblies

Assembly	Description
PL-0021514	AC Chassis – CDM-570AL (L-Band)
PL-0021177	Modem Board – CDM-570AL (L-Band)
PL-0021511	AC Chassis – CDM-570A (70/140 MHz)
PL-0021176	Modem Board – CDM-570A (70/140 MHz)

---

#### 1.2.1.2 Optional Assemblies

Assembly	Description
PL-0021515	-48V DC Chassis – CDM-570AL (L-Band)
PL-0021516	-24V DC Chassis – CDM-570AL (L-Band)
PL-0021512	-48V DC Chassis – CDM-570A (70/140 MHz)
PL-0021513	-24V DC Chassis – CDM-570A (70/140 MHz)
PL-0021412	0.95 Turbo Product Codec Card
PL-0021357	DoubleTalk Carrier-in-Carrier (CnC) Card
PL-0021625	Packet Processor Card
PL-0022376	VersaFEC-2 Option Card

## 1.2.2 Dimensional Envelope

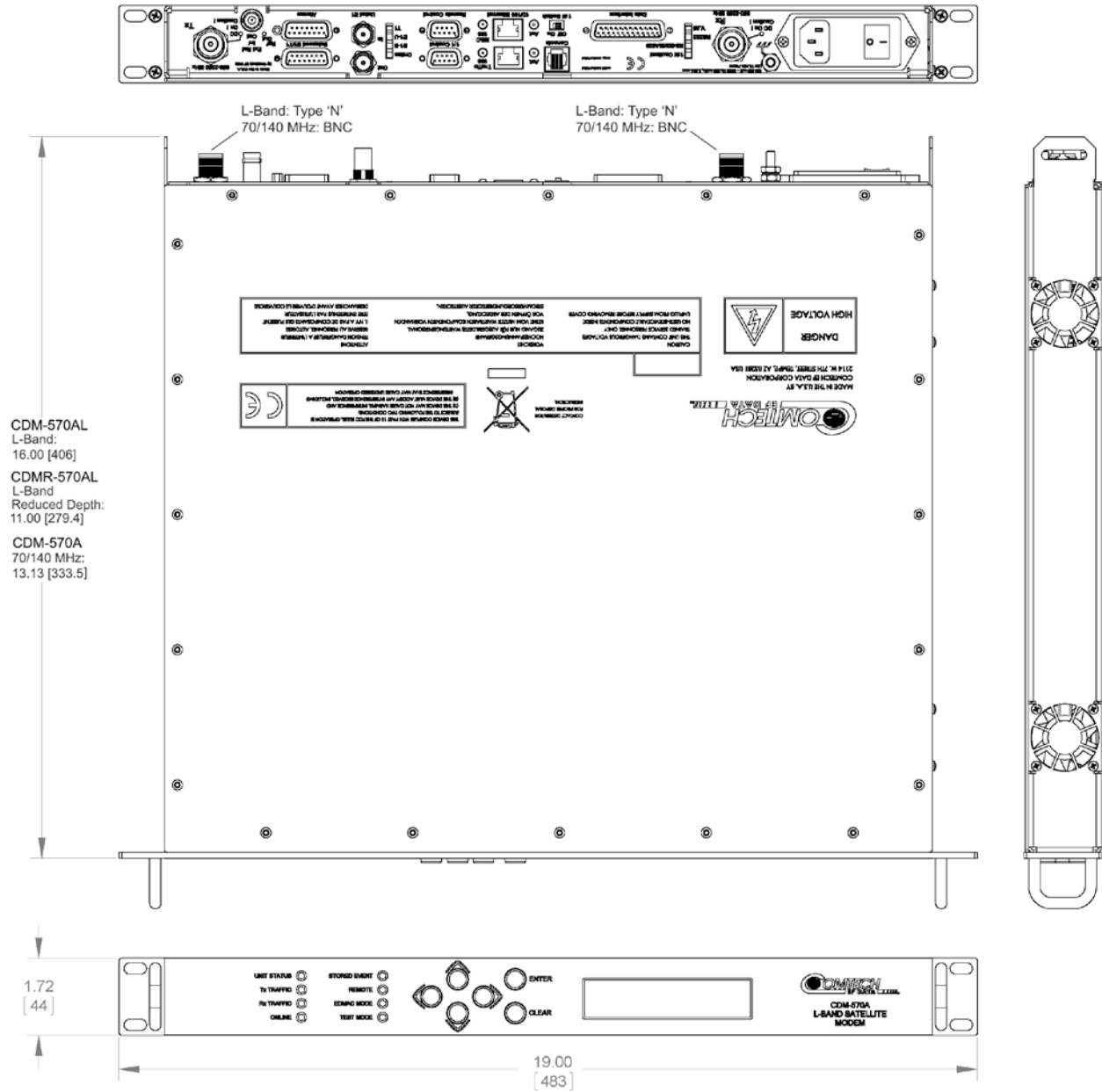

Figure 1-2. Modem Dimensional Envelope (Shown w/Optional Packet Processor)

## 1.2.3 Physical Features

### 1.2.3.1 Front Panel Features



- **Chapter 2. INSTALLATION**
- **Chapter 6. FRONT PANEL OPERATION**

The Light-emitting Diode (LED) indicators, keypad, and the Vacuum Fluorescent Display (VFD) (Figure 1-3) are described in detail in **Chapter 6. FRONT PANEL OPERATION**.

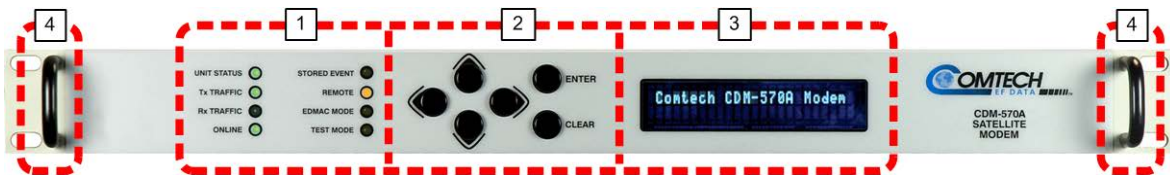

**Figure 1-3. Modem Front Panel View (CDM-570A Shown)**

#### 1 LED Indicators

The LEDs show a summary status of modem operation.

#### 2 Keypad

The keypad has six individual keys. The keys have a positive 'click' action that gives tactile feedback. Use the keypad to enter data.

#### 3 VFD

The VFD shows data, menus, prompts and messages. The VFD is an active display with adjustable brightness. It shows two lines of 24 characters each. Nested menus show all available options and prompts that guide you in carrying out required actions.

#### 4 Rack Handles

In a rack enclosure, these handles help you install and remove the modem.

### 1.2.3.2 Rear Panel Features



- Chapter 2. INSTALLATION
- Chapter 3. REAR PANEL CONNECTIONS



**CAUTION – CORRECT GROUNDING PROTECTION IS REQUIRED TO PREVENT PERSONAL INJURY AND EQUIPMENT DAMAGE. You must make sure the ground stud on the rear panel of the modem is always connected to the protective earth.**

External cables are attached to connectors provided on the rear panel of the modem



(TOP) Standard AC Chassis  
(MIDDLE) Optional -24V or -48V DC Chassis  
(BOTTOM) CDMR-570AL Reduced Chassis Depth Modem -24V or -48V DC Chassis

Figure 1-4. Modem Rear Panel View (Shown w/Optional Packet Processor)

#### 1.2.3.2.1 Rear Panel Standard Features

As per Figure 1-4, from left to right:

##### Power Interface:

- For the **CDM-570A/570AL** – 100V to 240V AC Primary Input Power Supply with Press-fit Fuse Holder.
- For the **CDMR-570AL** – -24V or -48V DC Primary Input Power Supply with Screw-in Fuse Holder.

##### IF Interfaces:

- For the **CDM-570AL** or **CDMR-570AL** – (2X) Type ‘N’ female “**Rx**” (at far left) and “**Tx**” (at far right) connectors for 50Ω L-Band (950 to 2250 MHz) operation.
- For the **CDM-570A** – (2X) BNC female “**Rx**” (at far left) and “**Tx**” (at far right) connectors for 70/140 MHz operation.

**LED Interfaces – Depending on the frequency, up to 14 LEDs are available:**

- **For the CDM-570AL or CDMR-570AL** – A *red* LED labeled “**DC On! Caution!**” is provided for the “**Rx**” (at far left) and the “**Tx**” (at far right) Type ‘N’ connectors, each indicating the presence of DC voltage.
  
- Six LEDs, all *orange*, indicate the active data interface type: RS422/EIA530, RS232, V.35, E1-B (G.703 E1 Balanced), E1-U (G.703 E1 Unbalanced), or T1 (G.703 T1).
  
- A *green* LED labeled “**ACT**” and an *orange* LED labeled “**M&C 100**” indicate operational status and the passing of 10/100 BaseT Ethernet-based remote product management data.
  
- **For systems in an optional redundant configuration:**
  - When the modem is connected to a 1:N switch, a *red* LED labeled “**1:N Caution!**” indicates that there may be DC voltages and other control signals present on certain pins on the 25-pin Data Interface connector.
  - A *green* LED labeled “**Online**” indicates the Online/Offline status of the modem.
  - A slide switch provides Off/On selection of the 1:N mode.

**Utility and Traffic Data Interfaces:**

- (1X) “Data Interface” DB-25F connector for serial-based synchronous data input/output.
- (1X) “Remote Control” DB-9M connector for EIA-232/-485 serial-based remote product management.
- (1X) “10/100 Ethernet | M&C 100” RJ-45 modular port for Ethernet-based remote product management.
- (1X each) “Unbal E1 | In” and “Unbal E1 | Out” BNC connectors for unbalanced G.703 E1 traffic.
- (1X) “Balanced E1/T1” DB-15F connector for balanced G.703 E1/T1 traffic.
- (1X) “Alarms” DB-15M connector for user access to the Form-C relay contacts that indicate the modem alarms/fault status.
- (1X) “Ext Ref In/Out” BNC female connector for External Reference.



### 1.2.3.2.2 Rear Panel Optional Features

As per **Figure 1-4**, from left to right:

#### **Power Interfaces:**

- -24V DC or -48V DC Primary Input Power Supply with Screw-in Fuse Holders.
- 24V DC 90 Watt BUC Power Supply (AC Input or DC Input versions).
- 48V DC 150 Watt BUC Power Supply (AC Input or DC Input versions).

#### **Utility and Traffic Data Interfaces:**

- (1X) "Console" RJ-11 modular jack. When equipped with the optional Packet Processor, this port provides access to the Serial CLI (Command Line Interface).
- (1X) "Ethernet 10/100 | Traffic 100" RJ-45 modular port. When equipped with the optional Packet Processor, this port processes 10/100 BaseT Ethernet-based traffic.
- (1X) "1:1 Control" DB-9F connector for to connect the modem only to a CRS-170A (L-Band) or CRS-180 (70/140 MHz) switch in optional 1:1 redundancy configurations.

#### **Mounting Tabs for Rear Panel Rack Support Brackets Kits:**

- KT/6228-2 4" Rear-Mounting Support Brackets Kit.
- KT/6228-3 10" Rear-Mounting Support Brackets Kit.

## 1.2.4 Standard Data Interfaces

The modem includes, as standard, a universal data interface that eliminates the need to exchange interface cards for different applications. The interfaces offered include:

- EIA-422 (EIA-530) DCE (at rates up to 10.239 Mbps)
- X.21 DTE and DCE (at rates up to 9.98 Mbps)
- V.35 DCE (at rates up to 9.98 Mbps)
- Synchronous EIA-232 DCE (at rates up to 300 kbps)
- G.703 E1 (2048 kbps), balanced and unbalanced
- G.703 T1 (1544 kbps), balanced

## 1.2.5 Verification

The modem includes many test modes and loopbacks for rapid verification of correct modem function. The IF loopback, in particular, permits execution of a quick diagnostic test without disturbing external cabling. During the loopback, all the receive configuration parameters temporarily change to match the transmit side, and an internal RF switch connects the modulator output to the demodulator input. All of the previous values are restored once normal operation is again selected.

## 1.2.6 AUPC



### APPENDIX E. AUPC (AUTOMATIC UPLINK POWER CONTROL)

AUPC (Automatic Uplink Power Control) is an important feature that enables the modem to automatically adjust its output power to maintain as constant the  $E_b/N_0$  of the remote end of the satellite link. This provides protection against rain fading, a particularly severe problem with Ku-Band links.

Note that you can simultaneously use both EDMAC and AUPC. A benefit of AUPC is that, whenever you select EDMAC/AUPC operation, you can view the remote demodulator's  $E_b/N_0$  from the front panel display of the local modem.

To accomplish AUPC, you must use the framed EDMAC mode of operation. The distant end modem constantly sends back information about the demodulator  $E_b/N_0$  using reserved bytes in the overhead structure. The local modem uses the  $E_b/N_0$  to adjust its output power and create a closed-loop feedback system over the satellite link.

## 1.2.7 EDMAC



### Appendix J. EDMAC CHANNEL

EDMAC facilitates network management for small networks. In this mode, an additional 5% overhead is combined with the traffic data, (1.6% in Turbo BPSK modes, Turbo Rate 21/44 QPSK/OQPSK, and all data rates greater than 2 Mbps). M&C information is added transparently, allowing access to the distant-end modem.

Additionally, EDMAC-2 uses 1.6% overhead in all modes for those applications where the 5% overhead is excessive. The EDMAC and EDMAC-2 modes do not require any additional cabling at either the local or the distant-end modems.

The standard M&C control port provides access to EDMAC. Full monitor and control is possible, and you may control the on/off status at the distant-end carrier.

## 1.2.8 Updating Modem Firmware



### Chapter 4. UPDATING FIRMWARE

The modem uses 'flash memory' technology internally. This simplifies firmware updating.

You may perform the firmware update, without opening the modem, remotely over satellite (when the modem is equipped with the optional Packet Processor), or by directly connecting a user-supplied Microsoft Windows-based PC to the modem 'Ethernet 10/100 | M&C 100' port (for modems without the optional Packet Processor) or the 'Ethernet 10/100 | Traffic 100' port (for modems equipped with the optional Packet Processor).

## 1.2.9 Fully Accessible System Topology (FAST)



### Chapter 5. FAST ACTIVATION PROCEDURE

The modem incorporates a number of optional features. In order to permit a lower initial cost, you may purchase the modem enabled with only the desired features.

If you wish to upgrade the functionality of a modem at a later date, Comtech EF Data provides FAST, which permits the purchase and activation of options through special authorization codes. You may contact Comtech EF Data Product Support to purchase these unique, register-specific FAST Access Codes, and then load these codes into the modem using the front panel keypad.

See **Table 1-1** for the standard (base modem) versus FAST and FAST-accessible hardware options available for the modem. You may order hardware options for basic modems for installation either at the factory or in the field. You can easily activate these options in the field.

**Table 1-1. Standard vs. FAST and FAST-accessible Hardware Options**

Option		Description and Comments		Install Method	
Forward Error Correction		Viterbi		BASE UNIT	
		VersaFEC Codec		FAST	
		VersaFEC-2 Codec		HW	
		Reed-Solomon (RS) Codec for CCM		FAST	
		2 <sup>nd</sup> Generation Turbo Product Codec (TPC) for CCM (IESS-315 compliant) – Rate 5/16, 21/44, 3/4 and 7/8		FAST	
		2 <sup>nd</sup> Generation Turbo Product Codec (TPC) Plug-in card for CCM – Rate 5/16, 21/44, 3/4, 7/8, and 0.95		HW	
Data Rate	Modem Data Rate for CCM	Data rate 2.4 kbps to 512 kbps		BASE UNIT	
		Data rate 2.4 kbps to 1.1 Mbps		FAST	
		Data rate 2.4 kbps to 2.5 Mbps (minimum required for G.703 operation)		FAST	
		Data rate 2.4 kbps to 5 Mbps		FAST	
		Data rate 2.4 kbps to 10.239 Mbps		FAST	
	VersaFEC Codec Data Rate for CCM	Tx Data Rate up to 512 kbps (Rx up to Modem Data Rate)		FAST	
		Tx Data Rate up to 1.1 Mbps (Rx up to Modem Data Rate)		FAST	
		Tx Data Rate up to 2.5 Mbps (Rx up to Modem Data Rate)		FAST	
		Tx Data Rate up to 5 Mbps (Rx up to Modem Data Rate)		FAST	
		Tx Data Rate up to 10.239 Mbps (Rx up to Modem Data Rate)		FAST	
Modulation Type		Standard (BPSK, QPSK, OQPSK)		BASE UNIT	
		Standard + 8PSK (requires RS or TPC), 8-QAM (requires TPC or VersaFEC)		FAST	
		Standard + 16QAM (requires RS or TPC or VersaFEC)		FAST	
		Standard + 8PSK and 8-QAM + 16-QAM (requires RS or TPC or VersaFEC)		FAST	
DoubleTalk Carrier-in-Carrier (CnC)	CnC Plug-in Card	Full Operation		HW	
		Fractional Operation		HW	
	CnC Data Rate	Full Operation	512 kbps		FAST
			1.1 Mbps		FAST
			2.5 Mbps		FAST
			5 Mbps		FAST
			10.239 Mbps		FAST
		Fractional Operation	2.5 Mbps		FAST
			5 Mbps		FAST
			0.239 Mbps		FAST
CnC-APC	CnC Automatic Power Control		FAST		
VersaFEC Adaptive Coding and Modulation (ACM)		Symbol rate up to 375 ksps		FAST	
		Symbol rate up to 750 ksps		FAST	
		Symbol rate up to 1500 ksps		FAST	
		Symbol rate up to 2000 ksps		FAST	
Packet Processor	Card	Packet Processor daughter card		HW	
	Payload Comp	Symbol rate up to 3000 ksps (VersaFEC ACM)		FAST	
	Header Comp	Symbol rate up to 3000 ksps (VersaFEC ACM)		FAST	
	3XDES	Tx Packet Encryption / Rx Packet Decryption		Available as EN model	

Option	Description and Comments	Install Method
Advanced QoS	Advanced Quality of Service	FAST
Carrier ID	Carrier ID	FAST
G.703	G.703 Clock Extension	FAST
Optimized Transmit Filter Rolloff (5%, 10%, 15%, 20%, 25%)	Up to 512 kbps for CCM	FAST
	Up to 1.1 Mbps for CCM	FAST
	Up to 2.5 Mbps for CCM	FAST
	Up to 5 Mbps for CCM	FAST
	Up to 10.239 Mbps for CCM	FAST
Primary Input Power Supplies (without BUC P/S)	100 to 240V AC	HW
	-24V DC	HW
	-48V DC	HW
Primary Input Power Supplies (with BUC P/S)	100 to 240V AC w/24V DC 90W @50°C BUC P/S	HW
	100 to 240V AC w/48V DC 150W @50°C BUC P/S	HW
	-24V DC w/24V DC 90W @50°C BUC P/S	HW
	-48V DC w/24V DC 90W @50°C BUC P/S	HW
	-48V DC w/48V DC 150W @50°C BUC P/S	HW

## 1.2.10 Supporting Hardware and Software

---

### 1.2.10.1 CDM-570AL/CDMR-570AL L-Band Redundancy

**For 1:1 applications,** the modem is supported by the low-cost external CRS-170A L-Band 1:1 Redundancy Switch.

**For Hub applications,** the modem is supported by the low-cost external CRS-300 1:N Redundancy Switch coupled with the CRS-280L (L-Band) Redundancy Switch.

---

### 1.2.10.2 CDM-570A 70/140 MHz Redundancy

**For 1:1 applications,** the modem is supported by the low-cost external CRS-180 70/140MHz 1:1 Redundancy Switch.

**For Hub applications,** the modem is supported by the low-cost external CRS-300 1:N Redundancy Switch coupled with the CRS-280 IF (70/140 MHz) Switch.

---

### 1.2.10.3 Support Software

The modem is supported by Comtech EF Data's Satellite system Monitor and Control (SatMac) Version 4.7 software, a Windows<sup>TM</sup>-based application that provides a 'point and click' interface for the complete system of Comtech EF Data equipment (comprising Modems, Transceivers, and Redundancy Switches).

Contact Comtech EF Data Product Support for more information or to order a free demo disk. SatMac is also available for download from the M&C Utilities link on Comtech EF Data's website.

## 1.3 Summary of Specifications

### 1.3.1 Modulator

Parameter	Specification
Modulation	BPSK, QPSK, OQPSK, 8-PSK, 8-QAM, and 16-QAM
Symbol Rate Range	4.8 ksps to 3000 ksps
Data Rate Range	See Section 1.3.6
Operating Modes	<ul style="list-style-type: none"> <li>• Transparent, Closed Network, IESS-315 (VSAT Turbo)</li> <li>• Proprietary EDMAC framed mode:               <ul style="list-style-type: none"> <li>○ 5% overhead – EDMAC (data rates &lt; 2.048 Mbps all modes except BPSK Turbo, Rate 21/44 QPSK Turbo)</li> <li>○ 1.6% overhead – EDMAC-2 (data rates &gt;2.048 Mbps and all Rate 21/44, 5/16 Turbo)</li> </ul> </li> <li>• R-S Outer Codec               <ul style="list-style-type: none"> <li>○ 220,200 outer code (transparent mode)</li> <li>○ 200,180 outer code (EDMAC modes)</li> </ul> </li> <li>• Turbo Product Codec – 2nd Generation Rates 21/44, 5/16, 21/44, 3/4, 7/8, and 0.95 (optional plug-in module for rate 0.95)</li> <li>• VersaFEC<sup>®</sup> Codec (short-block, low latency and ultra-low-latency LDPC)</li> <li>• VersaFEC-2 Codec (optional plug-in module, long-block, short-block)</li> <li>• VersaFEC-2 Adaptive Coding and Modulation – IP interface only – maximum symbol rate = 3.0 Msps</li> <li>• Automatic Uplink Power Control (AUPC) mode</li> <li>• DoubleTalk<sup>®</sup> Carrier-in-Carrier<sup>®</sup> mode (optional plug-in module)</li> </ul>
FEC	<ul style="list-style-type: none"> <li>• None: Uncoded BPSK/QPSK/OQPSK</li> <li>• Viterbi: k=7, per IESS-308/309               <ul style="list-style-type: none"> <li>○ BPSK: Rate 1/2</li> <li>○ QPSK/OQPSK: Rate 1/2, Rate 3/4 and Rate 7/8</li> <li>○ 16-QAM: Rate 3/4 and Rate 7/8 (requires Reed-Solomon)</li> </ul> </li> <li>• Reed-Solomon (Closed Network):               <ul style="list-style-type: none"> <li>○ 220,200 outer code (transparent mode)</li> <li>○ 200,180 outer code (EDMAC modes)</li> <li>○ Interleaver depth = 4</li> </ul> </li> <li>• 8-PSK/TCM Rate 2/3 (Trellis) with concatenated Reed-Solomon: CLOSED NETWORK - NOT IESS-310 COMPATIBLE</li> <li>• Turbo Product Codec:               <ul style="list-style-type: none"> <li>○ Rate 5/16 BPSK – 2 dimensional</li> <li>○ Rate 21/44 BPSK – 3 dimensional</li> <li>○ Rate 21/44 QPSK/OQPSK – 3 dimensional</li> <li>○ Rate 3/4 QPSK/OQPSK/8-PSK/8-QAM/16-QAM – 2 dimensional</li> <li>○ Rate 7/8 QPSK/OQPSK/8-PSK/8-QAM/16-QAM – 2 dimensional</li> <li>○ Rate 0.95 (optional plug-in card) QPSK/OQPSK/8-QAM/8-PSK – 2 dimensional eTPC (exact Code Rate is actually 17/18, or 0.944)</li> </ul> </li> <li>• VersaFEC Codec (FAST Option):               <ul style="list-style-type: none"> <li>○ Rate 0.488 BPSK (also 0.493 BPSK Ultra-Low-Latency)</li> <li>○ Rate 0.533, 0.631, 0.706, 0.803 QPSK (0.493, 0.654, 0.734 Ultra-Low-Latency)</li> <li>○ Rate 0.642, 0.711, 0.780 8-QAM (also 0.576 8-QAM Extended CCM)</li> <li>○ Rate 0.731, 0.780, 0.829, 0.853 16-QAM (also 0.644 16-QAM Extended CCM)</li> </ul> </li> <li>• VersaFEC-2<sup>®</sup> Long-Block Codec (Optional plug-in card – low latency LDPC):               <ul style="list-style-type: none"> <li>○ Rate 0.489 BPSK</li> <li>○ Rate 0.489, 0.537, 0.586, 0.611, 0.635, 0.660, 0.684, 0.733 QPSK</li> <li>○ Rate 0.521, 0.537, 0.562, 0.586, 0.611, 0.635, 0.660, 0.684, 0.708, 0.733 8-ARY</li> <li>○ Rate 0.586, 0.611, 0.635, 0.660, 0.684, 0.708, 0.733, 0.757, 0.782 16-ARY</li> <li>○ Rate 0.660, 0.684, 0.708, 0.733, 0.757, 0.782, 0.801, 0.831, 0.855, 0.879 32-ARY</li> </ul> </li> </ul>

Parameter	Specification								
FEC (cont.)	<ul style="list-style-type: none"> <li>• VersaFEC-2® Short-Block Codec (Optional plug-in card – low latency LDPC):               <ul style="list-style-type: none"> <li>○ Rate 0.489 BPSK</li> <li>○ Rate 0.489, 0.537, 0.586, 0.611, 0.635, 0.660, 0.684, 0.733 QPSK</li> <li>○ Rate 0.521, 0.537, 0.562, 0.586, 0.611, 0.635, 0.660, 0.684, 0.708, 0.733 8-ARY</li> <li>○ Rate 0.586, 0.611, 0.635, 0.660, 0.684, 0.708, 0.733, 0.757, 0.782 16-ARY</li> <li>○ Rate 0.660, 0.684, 0.708, 0.733, 0.757, 0.782, 0.801, 0.831 32-ARY</li> </ul> </li> </ul>								
Harmonics and Spurious	-60 dBc/4 kHz from 600 to 2600 MHz (L-Band) and from 1 to 400 MHz (IF)								
Transmit Filtering	Per Intelsat IESS-308 (FIR digital filter implementation) Root-Raised Cosine, alpha = 0.05, 0.10, 0.15, 0.20, 0.25, and 0.35 roll-off								
Transmit On/Off Ratio	55 dB minimum								
Scrambling	<ul style="list-style-type: none"> <li>• Transparent, Closed Network mode, no R-S or Turbo coding - per ITU V.35 (Intelsat variant)</li> <li>• EDMAC mode, no R-S coding - externally frame synchronized - proprietary</li> <li>• Turbo Product Code mode - externally frame synchronized - proprietary</li> <li>• All R-S modes - externally frame synchronized per IESS-308/309/310</li> <li>• All VersaFEC and VersaFEC-2 modes use IESS-315/V.35</li> </ul>								
Clocking Options	<ul style="list-style-type: none"> <li>• Internal – CDM-570AL or CDMR-570AL (L-Band)±0.06 ppm (SCT); CDM-570A (70/140 MHz) ±1.0 ppm (SCT)</li> <li>• External – Locking over a ±100 ppm range (TT)</li> <li>• Loop timing (Rx satellite clock) – Supports asymmetric operation; Rx and Tx data rates do not need to be identical</li> </ul>								
External TX Carrier Off	By TTL 'low' signal or external contact closure – hardware function automatically over-rides processor, or by RTS signal on main data interface								
Output Impedance	<p>CDM-570AL or CDMR-570AL (L-Band): 50Ω, &gt;17 dB from 950 to 2250 MHz and &gt;19 dB from 1000 to 1900 MHz minimum return loss</p> <p>CDM-570A (70/140 MHz): Compatible with 50Ω or 75Ω, 17 dB minimum return loss</p>								
Output Connector	<p>CDM-570AL or CDMR-570AL (L-Band): Type 'N' female</p> <p>CDM-570A (70/140 MHz): BNC female</p>								
Output Frequency	<p>CDM-570AL or CDMR-570AL (L-Band): 950 to 2250 MHz, 100 Hz resolution Stability ±0.06 ppm (±6 x 10<sup>-8</sup>) 0 to 50°C (32 to 122°F), when using internal reference</p> <p>CDM-570A (70/140 MHz): 50 to 90 MHz, and 100 to 180 MHz, 100 Hz resolution Stability ±1.0 ppm (±1 x 10<sup>-6</sup>) 0 to 50°C (32 to 122°F), when using internal reference</p>								
Output Phase Noise	<p>CDM-570AL or CDMR-570AL (L-Band): &lt;1.2° RMS double-sided, 100 Hz to 1 MHz for CDM-570AL and CDM-570AL-IP</p> <p>CDM-570A (70/140 MHz): &lt;0.75° RMS double-sided, 100 Hz to 1 MHz for CDM-570A and CDM-570A-IP</p>								
Output Power	<p>CDM-570AL or CDMR-570AL (L-Band): 0 to -40 dBm, 0.1 dB steps - manual mode. Also – see Sect. 1.2.6 for Automatic Uplink Power Control.</p> <p>CDM-570A (70/140 MHz): 0 to -25 dBm, 0.1 dB steps - manual mode. Also – see Sect. 1.2.6 for Automatic Uplink Power Control.</p>								
Power Accuracy	<p>CDM-570AL or CDMR-570AL (L-Band): ±1.0 dB over frequency, data rate, modulation type and temperature</p> <p>CDM-570A (70/140 MHz): ±0.5 dB over frequency, data rate, modulation type and temperature</p>								
BUC Reference (10 MHz)	<p>CDM-570AL or CDMR-570AL: On center conductor of L-Band output connector; 10.0 MHz ± 0.06 ppm* (Optional 1 ppm) -1.0 dBm, ± 4 dBm; programmable ON/OFF *Source: Selected as Internal.</p>								
Phase Noise	<table border="1"> <thead> <tr> <th>dB/Hz</th> <th>Frequency Offset</th> </tr> </thead> <tbody> <tr> <td>-110</td> <td>10 Hz</td> </tr> <tr> <td>-135</td> <td>100 Hz</td> </tr> <tr> <td>-140</td> <td>1 kHz</td> </tr> </tbody> </table>	dB/Hz	Frequency Offset	-110	10 Hz	-135	100 Hz	-140	1 kHz
dB/Hz	Frequency Offset								
-110	10 Hz								
-135	100 Hz								
-140	1 kHz								



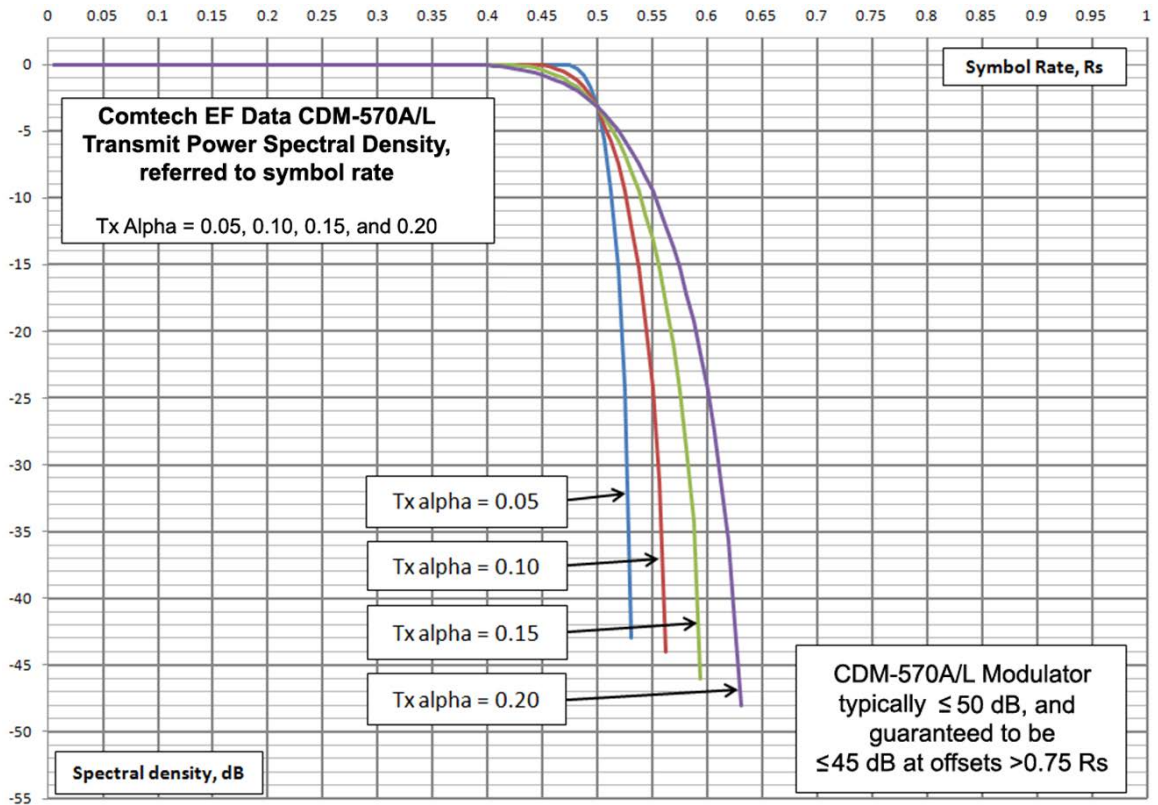
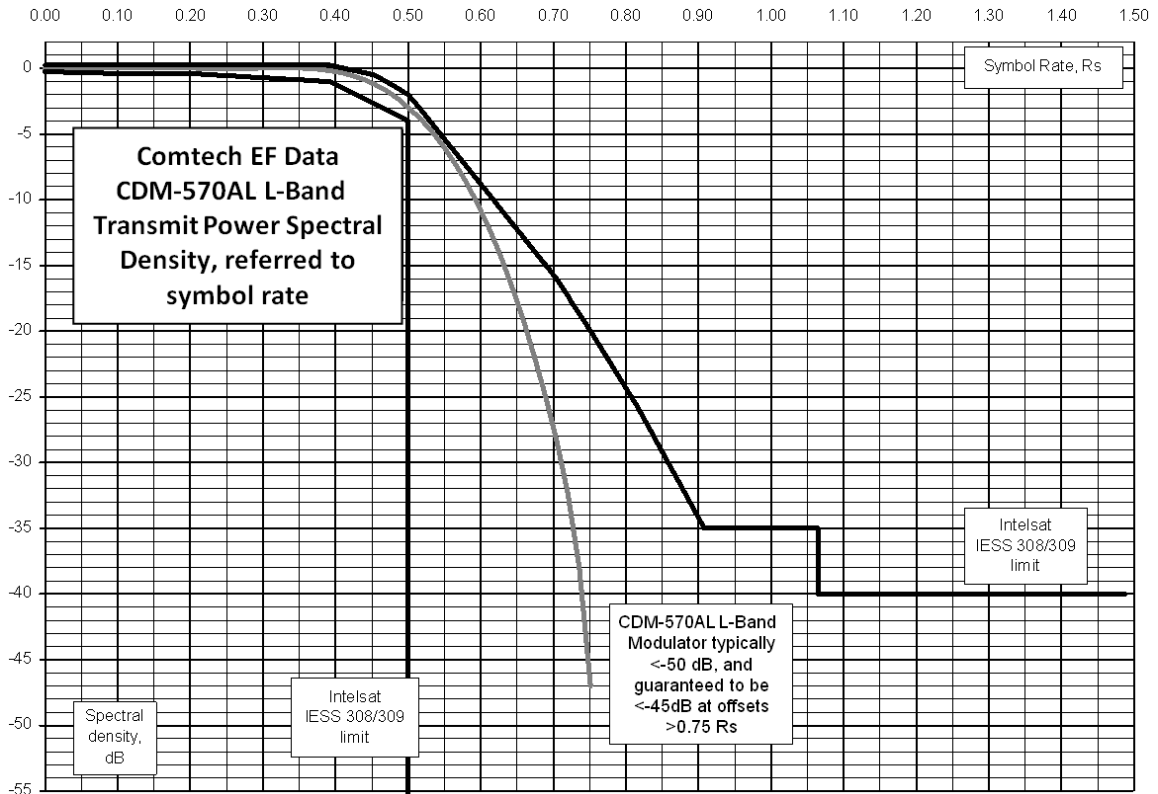

### 1.3.2 Demodulator



**Data Rate Range, Operating modes, Descrambling, Input Impedance/Return Loss, etc. are as specified in Section 1.3.1.**

Parameter	Specification
Input Power Range	CDM-570AL or CDMR-570AL (L-Band) Desired Carrier: $-130 + 10_{\log}(\text{Symbol Rate})$ to $-90 + 10_{\log}(\text{Symbol Rate})$ ; +40 dBc maximum composite, up to -10 dBm, absolute max.
	CDM-570A (70/140 MHz) Desired Carrier: -30 to -60 dBm. +35 dBc maximum composite, up to -5 dBm, absolute max.
FEC	<ul style="list-style-type: none"> <li>Viterbi: 3 bit soft decision</li> <li>Trellis: Pragmatic TCM/8-PSK with closed network concatenated Reed-Solomon</li> <li>Reed-Solomon (Closed Network): Proprietary</li> <li>Turbo Product Codec: 4 bit soft decision, proprietary</li> <li>VersaFEC: 6 bit soft decision, proprietary</li> <li>VersaFEC-2: 8 bit soft decision, proprietary</li> </ul>
Acquisition Range	$\pm 1$ to $\pm 32$ kHz, programmable in 1 kHz increments, for symbol rates below 625 ksymbols/sec $\pm 1$ to $\pm 200$ kHz, 1 kHz increments, for symbol rates above 625 ksymbols/sec, <b>L-Band only</b>
Acquisition Time	Highly dependent on data rate, FEC rate, and demodulator acquisition range. <b>Examples:</b> 120 ms average at 64 kbps, R1/2 QPSK, $\pm 10$ kHz acquisition sweep range, 6dB $E_b/N_0$ 3.5 s average at 9.6 kbps, R1/2 QPSK, $\pm 10$ kHz, 6dB $E_b/N_0$ <b>Note:</b> Reed-Solomon and TPC increases acquisition time, due to the additional time taken for the R-S/TPC decoder to declare synchronization.
Clock Tracking Range	$\pm 100$ ppm min
Plesiochronous/ Doppler Buffer	Selectable size of $\pm 128, 256, 512, 1024, 2048, 4096, 8192, 16384$ and $32768$ bits Size selection is displayed in bits and milliseconds. Supports asymmetric operation – when buffer is clocked from Tx clock, Rx and Tx rates do not need to be identical.
Monitor Functions	$E_b/N_0$ estimate, 2 to 16 dB ( $\pm 0.25$ dB accuracy) Corrected Bit Error Rate, $1E-3$ to $1E-9$ Frequency offset, $\pm 200$ kHz range, 100 Hz resolution Buffer fill state, in percent Receive signal level monitor accuracy: $\pm 5$ dB for CDM-570AL L-Band, $\pm 3$ dB for CDM-570A over specified min to max signal range

#### 1.3.2.1 BER Performance Specification

BER Description	For BER=	Rate Guaranteed $E_b/N_0$ (typical value in parentheses)		
		$1/2$ (BPSK, QPSK, OQPSK)	$3/4$ (QPSK, OPQSK)	$7/8$ (QPSK, OPQSK)
VITERBI (Met in the presence of two adjacent carriers, each 7 dB higher than the desired carrier)	$10^{-5}$	5.4 dB (4.9 dB)	6.8 dB (6.3 dB)	7.7 dB (7.2 dB)
	$10^{-6}$	6.0 dB (5.5 dB)	7.4 dB (6.9 dB)	8.4 dB (7.9 dB)
	$10^{-7}$	6.7 dB (6.2 dB)	8.2 dB (7.7 dB)	9.0 dB (8.6 dB)
VITERBI and R-S 220,200 or 200,180 Outer Code (With two adjacent carriers, each 7 dB higher than the desired carrier)	$10^{-5}$	4.3 dB (4.0 dB)	5.6 dB (4.7 dB)	6.5 dB (6.0 dB)
	$10^{-6}$	4.4 dB (4.1 dB)	5.8 dB (4.8 dB)	6.7 dB (6.2 dB)
	$10^{-7}$	4.5 dB (4.2 dB)	6.0 dB (5.2 dB)	6.9 dB (6.5 dB)
8-PSK/TCM/R-S CODEC (With two adjacent carriers, each 7 dB higher than the desired carrier)	$10^{-5}$	6.3 dB (5.4 dB)		
	$10^{-7}$	6.7 dB (5.8 dB)		
	$10^{-8}$	6.9 dB (6.0 dB)		

BER Description	For BER=	Rate			
		Guaranteed Eb/No ((typical value in parentheses)			
TURBO PRODUCT CODEC Rate 21/44 QPSK Rate 21/44 BPSK Rate 5/16 BPSK (With two adjacent carriers, each 7 dB higher than the desired carrier)	10 <sup>-6</sup>	21/44 (QPSK, OQPSK) 2.9 dB (2.6 dB)	21/44 (BPSK) 2.8 dB (2.5dB)	5/16 (BPSK) 2.4 dB (2.1dB)	
	10 <sup>-7</sup>	3.1 dB (2.7 dB)	3.1 dB (2.8 dB)	2.6 dB (2.3dB)	
	10 <sup>-8</sup>	3.3 dB (2.8 dB)	3.3 dB (2.90dB)	2.7 dB (2.4dB)	
TURBO PRODUCT CODEC Rate 3/4 QPSK Rate 3/4 8-PSK Rate 3/4 16-QAM (With two adjacent carriers, each 7 dB higher than the desired carrier)	10 <sup>-6</sup>	3/4 (QPSK, OPQSK) 3.8dB (3.4dB)	3/4 (8-PSK) 6.2 dB (5.8 dB)	Rate 3/4 (16-QAM) 7.4dB (7.0 dB)	
	10 <sup>-7</sup>	4.1dB (3.7dB)	6.4 dB (6.0 dB)	7.8 dB (7.3 dB)	
	10 <sup>-8</sup>	4.4dB (4.0dB)	6.8 dB (6.3 dB)	8.2 dB (7.7 dB)	
TURBO PRODUCT CODEC Rate 7/8 QPSK Rate 7/8 8-PSK Rate 7/8 16-QAM (With two adjacent carriers, each 7 dB higher than the desired carrier)	10 <sup>-6</sup>	Rate 7/8 (QPSK, OPQSK) 4.3 dB (4.0 dB)	Rate 7/8 (8-PSK) 7.0 dB (6.6 dB)	Rate 7/8 (16-QAM) 8.1 dB (7.7 dB)	
	10 <sup>-7</sup>	4.4 dB (4.1 dB)	7.1 dB (6.7 dB)	8.2 dB (7.8 dB)	
	10 <sup>-8</sup>	4.5 dB (4.2 dB)	7.2 dB (6.8 dB)	8.3 dB (7.9 dB)	
TURBO PRODUCT CODEC Rate 0.95 QPSK Rate 0.95 8-PSK (With two adjacent carriers, each 7 dB higher than the desired carrier)	10 <sup>-6</sup>	Rate 0.95 (QPSK, OPQSK) 6.4 dB (6.0 dB)	Rate 0.95 (8-PSK) 9.3 dB (8.9 dB)		
	10 <sup>-7</sup>	6.7 dB (6.3 dB)	9.8 dB (9.4 dB)		
	10 <sup>-8</sup>	6.9 dB (6.5 dB)	10.3 dB (9.9 dB)		
TURBO PRODUCT CODEC Rate 3/4 8-QAM Rate 7/8 8-QAM Rate 0.95 8-QAM (With two adjacent carriers, each 7 dB higher than the desired carrier)	10 <sup>-6</sup>	Rate 3/4 (8-QAM) 6.5 dB (6.1 dB)	Rate 7/8 (8-QAM) 6.6 dB (6.2 dB)	Rate 0.95 (8-QAM) 9.6 dB (9.2 dB)	
	10 <sup>-7</sup>	6.8 dB (6.4 dB)	6.7 dB (6.3 dB)	10.1 dB (9.7 dB)	
	10 <sup>-8</sup>	7.2 dB (6.8 dB)	6.8 dB (6.4 dB)	10.6 dB (10.2 dB)	
16-QAM VITERBI/R-S (With two adjacent carriers, each 7 dB higher than the desired carrier)	10 <sup>-6</sup>	3/4 Viterbi/R-S (16-QAM) 8.1 dB (7.5 dB)	7/8 Viterbi/R-S (16-QAM) 9.5 dB (9.0 dB)		
	10 <sup>-8</sup>	8.6 dB (8.0 dB)	10.1 dB (9.5 dB)		
VersaFEC CODEC BPSK (With two adjacent carriers, each 7 dB higher than the desired carrier)	10 <sup>-5</sup>	0.488 (BPSK) 2.4 dB (2.1 dB)			
	10 <sup>-8</sup>	2.7 dB (2.4 dB)			
VersaFEC CODEC QPSK (With two adjacent carriers, each 7 dB higher than the desired carrier)	10 <sup>-5</sup>	0.533 (QPSK) 2.3 dB (2.0 dB)	0.631 (QPSK) 2.8 dB (2.5 dB)	0.706 (QPSK) 3.3 dB (3.0 dB)	
	10 <sup>-8</sup>	2.5 dB (2.2 dB)	3.0 dB (2.7 dB)	3.7 dB (3.4 dB)	
VersaFEC CODEC 8-QAM (With two adjacent carriers, each 7 dB higher than the desired carrier)	10 <sup>-5</sup>	0.642 (8-QAM) 4.6 dB (4.3 dB)	0.711 (8-QAM) 5.2 dB (4.9 dB)	0.780 (8-QAM) 5.6 dB (5.3 dB)	
	10 <sup>-8</sup>	4.9 dB (4.6 dB)	5.5 dB (5.2 dB)	6.0 dB (5.7 dB)	
VersaFEC CODEC 16-QAM (With two adjacent carriers, each 7 dB higher than the desired carrier)	10 <sup>-5</sup>	0.731 (16-QAM) 6.6 dB (6.3 dB)	0.780 (16-QAM) 7.1 dB (6.8 dB)	0.829 (16-QAM) 7.7 dB (7.4 dB)	
	10 <sup>-8</sup>	6.8 dB (6.5 dB)	7.4 dB (7.1 dB)	8.0 dB (7.7 dB)	
VersaFEC CODEC – Extended CCM (With two adjacent carriers, each 7 dB higher than the desired carrier)	10 <sup>-5</sup>	0.576 (8-QAM) 4.5 dB (4.2 dB)	0.644 (16-QAM) 6.4 dB (6.1 dB)		
	10 <sup>-8</sup>	4.9 dB (4.6 dB)	6.9 dB (6.6 dB)		
VersaFEC-2 Long Block CODEC BPSK (With two adjacent carriers, each 7 dB higher than the desired carrier)	10 <sup>-4</sup>	0.489 BPSK 1.8 dB (1.5 dB)			
	10 <sup>-8</sup>	2.1 dB (1.8 dB)			

BER Description	For BER=	Rate			
		Guaranteed Eb/No ((typical value in parentheses)			
VersaFEC-2 Long Block CODEC BPSK (With two adjacent carriers, each 7 dB higher than the desired carrier)	10 <sup>-4</sup>	<b>0.489 QPSK</b> 1.7 dB (1.4 dB)	<b>0.537 QPSK</b> 1.8 dB (1.5 dB)	<b>0.586 QPSK</b> 2.0 dB (1.7 dB)	<b>0.611 QPSK</b> 2.1 dB (1.8 dB)
	10 <sup>-8</sup>	1.9 dB (1.6 dB)	2.0 dB (1.7 dB)	2.2 dB (1.9 dB)	2.2 dB (1.9 dB)
	10 <sup>-4</sup>	<b>0.635 QPSK</b> 2.3 dB (2.0 dB)	<b>0.660 QPSK</b> 2.4 dB (2.1 dB)	<b>0.684 QPSK</b> 2.4 dB (2.1 dB)	<b>0.733 QPSK</b> 2.8 dB (2.5 dB)
	10 <sup>-8</sup>	2.5 dB (2.2 dB)	2.6 dB (2.3 dB)	2.6 dB (2.3 dB)	3.0 dB (2.7 dB)
VersaFEC-2 Long Block CODEC 8-ARY (With two adjacent carriers, each 7 dB higher than the desired carrier)	10 <sup>-4</sup>	<b>0.521 8-ARY</b> 3.2 dB (2.9 dB)	<b>0.537 8-ARY</b> 3.2 dB (2.9 dB)	<b>0.562 8-ARY</b> 3.3 dB (3.0 dB)	<b>0.586 8-ARY</b> 3.3 dB (3.0 dB)
	10 <sup>-8</sup>	3.5 dB (3.2 dB)	3.6 dB (3.3 dB)	3.6 dB (3.6 dB)	3.6 dB (3.6 dB)
	10 <sup>-4</sup>	<b>0.611 8-ARY</b> 3.4 dB (3.1 dB)	<b>0.635 8-ARY</b> 3.5 dB (3.2 dB)	<b>0.660 8-ARY</b> 3.7 dB (3.4 dB)	<b>0.684 8-ARY</b> 3.9 dB (3.6 dB)
	10 <sup>-8</sup>	3.7 dB (3.4 dB)	3.7 dB (3.4 dB)	3.8 dB (3.5 dB)	4.1 dB (3.8 dB)
	10 <sup>-4</sup>	<b>0.708 8-ARY</b> 4.0 dB (3.7 dB)	<b>0.733 8-ARY</b> 4.3 dB (4.0 dB)		
	10 <sup>-8</sup>	4.2 dB (3.9 dB)	4.4 dB (4.1 dB)		
VersaFEC-2 Long Block CODEC 16-ARY (With two adjacent carriers, each 7 dB higher than the desired carrier)	10 <sup>-4</sup>	<b>0.586 16-ARY</b> 4.4 dB (4.1 dB)	<b>0.611 16-ARY</b> 4.7 dB (4.4 dB)	<b>0.635 16-ARY</b> 4.9 dB (4.6 dB)	<b>0.660 16-ARY</b> 5.1 dB (4.8 dB)
	10 <sup>-8</sup>	4.7 dB (4.4 dB)	5.0 dB (4.7 dB)	5.2 dB (4.9 dB)	5.3 dB (5.0 dB)
	10 <sup>-4</sup>	<b>0.684 16-ARY</b> 5.3 dB (5.0 dB)	<b>0.708 16-ARY</b> 5.6 dB (5.3 dB)	<b>0.733 16-ARY</b> 5.9 dB (5.6 dB)	<b>0.757 16-ARY</b> 6.2 dB (5.9 dB)
	10 <sup>-8</sup>	5.5 dB (5.2 dB)	5.8 dB (5.5 dB)	6.1 dB (5.8 dB)	6.4 dB (6.1 dB)
	10 <sup>-4</sup>	<b>0.782 16-ARY</b> 6.5 dB (6.2 dB)			
	10 <sup>-8</sup>	6.7 dB (6.4 dB)			
VersaFEC-2 Long Block CODEC 32-ARY (With two adjacent carriers, each 7 dB higher than the desired carrier)	10 <sup>-4</sup>	<b>0.660 32-ARY</b> 6.8 dB (6.5 dB)	<b>0.684 32-ARY</b> 7.2 dB (6.9 dB)	<b>0.708 32-ARY</b> 7.4 dB (7.1 dB)	<b>0.733 32-ARY</b> 7.7 dB (7.4 dB)
	10 <sup>-8</sup>	7.1 dB (6.8 dB)	7.5 dB (7.2 dB)	7.7 dB (7.4 dB)	8.0 dB (7.7 dB)
	10 <sup>-4</sup>	<b>0.757 32-ARY</b> 8.0 dB (7.7 dB)	<b>0.782 32-ARY</b> 8.4 dB (8.1 dB)	<b>0.801 32-ARY</b> 8.8 dB (8.5 dB)	<b>0.831 32-ARY</b> 9.1 dB (8.8 dB)
	10 <sup>-8</sup>	8.2 dB (7.9 dB)	8.6 dB (8.3 dB)	9.0 dB (8.7 dB)	9.3 dB (9.0 dB)
	10 <sup>-4</sup>	<b>0.855 32-ARY</b> 9.8 dB (9.5 dB)	<b>0.879 32-ARY</b> 10.4 dB (10.1 dB)		
	10 <sup>-8</sup>	10.0 dB (9.7 dB)	10.6 dB (10.3 dB)		
VersaFEC-2 Short Block CODEC BPSK (With two adjacent carriers, each 7 dB higher than the desired carrier)	10 <sup>-4</sup>	<b>0.489 BPSK</b> 2.6 dB (2.3 dB)			
	10 <sup>-8</sup>	3.2 dB (2.9 dB)			
VersaFEC-2 Short Block CODEC QPSK (With two adjacent carriers, each 7 dB higher than the desired carrier)	10 <sup>-4</sup>	<b>0.489 QPSK</b> 2.3 dB (1.4 dB)	<b>0.537 QPSK</b> 2.4 dB (2.1 dB)	<b>0.586 QPSK</b> 2.5 dB (2.2 dB)	<b>0.611 QPSK</b> 2.6 dB (2.3 dB)
	10 <sup>-8</sup>	2.7 dB (1.6 dB)	2.0 dB (1.7 dB)	3.0 dB (2.7 dB)	3.1 dB (2.8 dB)
	10 <sup>-4</sup>	<b>0.635 QPSK</b> 2.8 dB (2.5 dB)	<b>0.660 QPSK</b> 2.9 dB (2.6 dB)	<b>0.684 QPSK</b> 3.0 dB (2.7 dB)	<b>0.733 QPSK</b> 3.4 dB (3.1 dB)
	10 <sup>-8</sup>	3.2 dB (2.9 dB)	3.3 dB (3.0 dB)	3.4 dB (3.1 dB)	3.8 dB (3.5 dB)

BER Description	For BER=	Rate Guaranteed Eb/No ((typical value in parentheses))			
VersaFEC-2 Short Block CODEC 8-ARY (With two adjacent carriers, each 7 dB higher than the desired carrier)	10 <sup>-4</sup>	<b>0.521 8-ARY</b> 3.5 dB (3.2 dB)	<b>0.537 8-ARY</b> 3.5 dB (3.2 dB)	<b>0.562 8-ARY</b> 3.6 dB (3.6 dB)	<b>0.586 8-ARY</b> 3.7 dB (3.4 dB)
	10 <sup>-8</sup>	4.0 dB (3.7 dB)	4.1 dB (3.8 dB)	4.2 dB (3.9 dB)	4.2 dB (3.9 dB)
	10 <sup>-4</sup>	<b>0.611 8-ARY</b> 3.9 dB (3.6 dB)	<b>0.635 8-ARY</b> 3.9 dB (3.6 dB)	<b>0.660 8-ARY</b> 4.1 dB (3.8 dB)	<b>0.684 8-ARY</b> 4.4 dB (4.1 dB)
	10 <sup>-8</sup>	4.3 dB (4.0 dB)	4.4 dB (4.1 dB)	4.5 dB (4.2 dB)	4.7 dB (4.4 dB)
	10 <sup>-4</sup>	<b>0.708 8-ARY</b> 4.5 dB (4.2 dB)	<b>0.733 8-ARY</b> 4.8 dB (4.5 dB)		
	10 <sup>-8</sup>	4.8 dB (4.5 dB)	5.2 dB (4.9 dB)		
VersaFEC-2 Short Block CODEC 16-ARY (With two adjacent carriers, each 7 dB higher than the desired carrier)	10 <sup>-4</sup>	<b>0.586 16-ARY</b> 4.8 dB (4.5 dB)	<b>0.611 16-ARY</b> 5.0 dB (4.7 dB)	<b>0.635 16-ARY</b> 5.3 dB (5.0 dB)	<b>0.660 16-ARY</b> 5.5 dB (5.2 dB)
	10 <sup>-8</sup>	5.3 dB (5.0 dB)	5.4 dB (5.1 dB)	5.6 dB (5.3 dB)	5.8 dB (5.5 dB)
	10 <sup>-4</sup>	<b>0.684 16-ARY</b> 5.7 dB (5.4 dB)	<b>0.708 16-ARY</b> 6.1 dB (5.8 dB)	<b>0.733 16-ARY</b> 6.2 dB (5.9 dB)	<b>0.757 16-ARY</b> 6.7 dB (6.4 dB)
	10 <sup>-8</sup>	6.2 dB (5.9 dB)	6.5 dB (6.2 dB)	6.6 dB (6.3 dB)	7.1 dB (6.8 dB)
	10 <sup>-4</sup>	<b>0.782 16-ARY</b> 7.0 dB (6.7 dB)			
	10 <sup>-8</sup>	7.5 dB (7.2 dB)			
VersaFEC-2 Short Block CODEC 32-ARY (With two adjacent carriers, each 7 dB higher than the desired carrier)	10 <sup>-4</sup>	<b>0.660 32-ARY</b> 7.3 dB (7.0 dB)	<b>0.684 32-ARY</b> 7.5 dB (7.2 dB)	<b>0.708 32-ARY</b> 7.7 dB (7.4 dB)	<b>0.733 32-ARY</b> 8.2 dB (7.9 dB)
	10 <sup>-8</sup>	7.9 dB (7.6 dB)	8.1 dB (7.8 dB)	8.2 dB (7.9 dB)	8.7 dB (8.4 dB)
	10 <sup>-4</sup>	<b>0.757 32-ARY</b> 8.4 dB (8.1 dB)	<b>0.782 32-ARY</b> 8.7 dB (8.4 dB)	<b>0.801 32-ARY</b> 9.1 dB (8.8 dB)	<b>0.831 32-ARY</b> 9.5 dB (9.2 dB)
	10 <sup>-8</sup>	8.9 dB (8.6 dB)	9.2 dB (8.9 dB)	9.5 dB (9.2 dB)	9.9 dB (9.6 dB)
ULL CODEC (With two adjacent carriers, each 7 dB higher than the desired carrier)	10 <sup>-5</sup>	<b>0.493 (BPSK)</b> 3.1 dB (2.8 dB)	<b>0.493 (QPSK)</b> 3.1 dB (2.8 dB)	<b>0.654 (QPSK)</b> 3.6 dB (3.3 dB)	<b>0.734 (QPSK)</b> 4.1 dB (3.8 dB)
	10 <sup>-8</sup>	3.7 dB (3.4 dB)	3.7 dB (3.4 dB)	4.2 dB (3.9 dB)	4.7 dB (4.4 dB)

### 1.3.3 Standard AUPC (Automatic Uplink Power Control)

Parameter	Specification
Operating Mode	Requires Closed Network Framed mode for transport of Eb/No information from remote modem (EDMAC can be enabled or disabled)
Target Eb/No Range	0 to 14.9 dB at remote demod (default is 4.0 dB)
Max AUPC Range	0 to 9 dB (default is 3 dB)
Monitor Functions	Remote demod Eb/No and Tx power level increase (front panel or via remote control interface)

### 1.3.4 DoubleTalk® Carrier- in-Carrier® (CnC)

Parameter	Specification
Operating Mode	Requires the two links to share a common carrier frequency (Outbound and Inbound symbol rates do not have to be equal)
Power Spectral Density Ratio and CnC Ratio	<p>BSPK/QPSK/8PSK/8-QAM: -7 dB to +11 dB (ratio of power spectral density, outbound interferer to desired inbound)</p> <p>16-QAM: -7 dB to +7 dB (ratio of power spectral density, outbound interferer to desired inbound)</p> <p><b>Note:</b> With asymmetric carriers, the absolute power ratio (or CnC ratio) would be different, depending on the ratio of the symbol rates.</p> <p><b>Example:</b>            Outbound interferer = 1 Msymbols/sec            Desired Inbound = 500 ksymbols/sec            Ratio of power spectral density = +7 dB            Absolute power ratio (<b>CnC Ratio</b>) = +7dB + (10<sub>log</sub> Outbound/desired symbol rate) = +10 dB</p>
Maximum Symbol Rate Ratio	3:1 (TX:RX or RX:TX)
Inbound/Outbound frequency uncertainty	<p>Within the normal acquisition range of the demod, as follows:</p> <p><b>CDM-570AL or CDMR-570AL (L-Band):</b>            Below 64 ksymbols/sec: ±1 to ±(Rs/2) kHz, where Rs = symbol rate in ksymbols/sec            Between 64 and 625 ksymbols/sec: ±1 up to a maximum of ±32kHz.            Above 625 ksymbols/sec: ±1 to ±(0.1Rs) kHz, up to a maximum of ±200 kHz</p> <p><b>CDM-570A (70/140 MHz):</b>            Below 64 ksymbols/sec: ±1 to ±(Rs/2) kHz, where Rs = symbol rate in ksymbols/sec            Equal to 64 ksymbols/sec and above: ±1 up to a maximum of ±32kHz.</p>
Delay range	0-330 ms
Eb/No Degradation (equal Inbound/Outbound power spectral density)	<p>BPSK = 0.3dB    QPSK = 0.3dB    OQPSK = 0.3dB            8PSK = 0.5dB    8-QAM = 0.4dB    16-QAM = 0.6dB</p> <p>For +10 dB power spectral density ratio (outbound interferer 10 dB higher than desired inbound) add an additional 0.3 dB</p>
Monitor Functions	<p>Delay, in milliseconds</p> <p>Frequency offset (between outbound interferer and desired inbound). 100 Hz resolution</p> <p>CnC Power Ratio, in 0.1 dB (ratio of absolute power, outbound interferer to desired inbound)</p> <p>Power Spectral Density Ratio, in 0.1 dB</p>
CnC Monitor Accuracy	±0.2 dB for symmetric symbol rate

### 1.3.5 Data and Miscellaneous Interfaces

Connector	Function	Type
Primary Data (3 selectable modes)	RS-422/EIA-530 DCE (Rates up to 10 Mbps) (also supports X.21 DCE & DTE) V.35 DCE (Rates up to 10 Mbps) Synchronous EIA-232 (Rates up to 300 kbps)	25-pin D-sub (female)
Optional G.703	1.544 Mbps T1 (Balanced 100 $\Omega$ ) 2.048 Mbps E1 (unbalanced 75 $\Omega$ or balanced 120 $\Omega$ )	15-pin D-sub (female) or BNC (female)
External Reference Input/Output	<b>As an input:</b> 1, 2, 5 or 10MHz -6dBm to +10dBm (nominal 50/75 $\Omega$ , BNC female connector) <b>As an output:</b> 10MHz, 2.7 volts peak-to-peak $\pm$ 0.4 volts, low impedance output (The Ext. reference phase locks Tx and Rx synthesizers, and all baseband clock generation)	BNC (female)
Modem Alarms	Relay outputs (Tx, Rx & unit faults) Demodulator I & Q test outputs (constellation) Demodulator Rx Signal Level output (0 to 10 volts) External carrier off input	15-pin D-sub (male)
1:1 Control	Async serials link to other modem, and switching signals in 1:1 pair, via CRS-170A	9-pin D-sub (female)
Alarm Relay	Type: Form C Contacts. Rating: 125V AC/30V DC, 0.3A AC/1A DC	15-pin D-sub (male)
Remote Control	EIA-232 or EIA-485 modem control and monitoring	9-pin D-sub (male)
Ethernet	10/100 Base Tx for http, SNMP and Telnet interfaces	RJ-45

### 1.3.6 Data Rate Ranges

FEC Type	Modulation	Code Rate	Data Rate Range		EDMAC limited?
			Lower Limit (kbps)	Upper Limit (Mbps)	
None	BPSK	Uncoded	4.8	3.000	Yes – see "Important Note" below
	QPSK/OQPSK	Uncoded	9.6	5.000	
Viterbi	BPSK	1/2	2.4	1.500	
		1/2	4.8	3.000	
	QPSK/OQPSK	3/4	7.2	4.500	
		7/8	8.4	5.250	
Viterbi + R-S	BPSK	1/2	2.4	1.363	
	QPSK/OQPSK	1/2	4.3	2.727	
		3/4	6.5	4.091	
		7/8	7.5	4.666	
	16-QAM	3/4	13.0	4.000	
		7/8	16.8	4.666	
TCM + R-S	8-PSK	2/3	8.7	4.400	
Turbo	BPSK	5/16	2.4	0.937	
		21/44	2.4	1.430	
	QPSK/OQPSK	21/44	4.8	2.860	
		3/4	7.2	4.500	
		7/8	8.4	5.250	
		0.95	9.1	5.666	
	8-PSK/8-QAM	3/4	10.8	6.750	
		7/8	13.6	7.875	
		0.95	15.3	8.500	
		16-QAM	3/4	14.4	9.000
		7/8	16.8	9.980	
VersaFEC	BPSK	0.488	2.4	1.462	No
	QPSK	0.533	5.2	3.200	
		0.631	6.1	3.785	
		0.706	6.8	4.233	
		0.803	7.8	4.818	
	8-QAM	0.576	8.3	5.179	
		0.642	9.3	5.782	
		0.711	10.3	6.401	
		0.780	11.3	7.021	
	16-QAM	0.644	12.4	7.726	
		0.731	14.1	8.776	
		0.780	15.0	9.361	
		0.829	16.0	9.946	
0.853		16.4	10.239		
Ultra-Low Latency (ULL)	BPSK	0.493	2.4	1.480	
	QPSK	0.493	4.7	2.960	
		0.654	6.3	3.924	
		0.734	7.0	4.405	
VersaFEC Adaptive Coding and Modulation (IP-ACM)	See Section 1.3.7.1				



FEC Type	Modulation	Code Rate	Data Rate Range		EDMAC limited?
			Lower Limit (kbps)	Upper Limit (Mbps)	
VersaFEC-2 Adaptive Coding and Modulation (V2-ACM)	See Section 1.3.7.2				



**Important Note – where noted in this table: If EDMAC framing is employed, the upper data rate will be reduced by 5% for data rates up to 2.048 Mbps, and by 1.6% for data rates above 2.048 Mbps where EDMAC2 framing is used, or for Rate 21/44 BPSK/QPSK Turbo, or Rate 5/16 BPSK Turbo.**

## 1.3.7 VersaFEC Adaptive Coding and Modulation (ACM)

### 1.3.7.1 VersaFEC ACM (IP-ACM)

System Type	Adaptive Coding and Modulation, using BPSK, QPSK, 8-QAM , 16-QAM and VersaFEC short-block LDPC coding – total of 12 ModCods
Symbol Rate Range	37-3000 ksps
Interface	10/100 Base T Ethernet, with auto-negotiated Congestion Control
Remote SNR Reporting	Automatically reported from remote modem – built in function at the physical layer – requires no additional overhead
Max Span of Data Rate	7:1 over range of adaptation
Switch Point (decreasing SNR)	Corresponds to SNR (Eb/No) that gives BER = $5 \times 10^{-8}$
Switch Point Hysteresis	0.3 dB
Max Fading Rate	Approximately 1 dB/second (higher if Target Eb/No margin >1 dB)
Max ModCod Update Rate	One update every two seconds (no restriction on distance between ModCods)
Configurable Parameters	<ul style="list-style-type: none"> <li>Minimum and Maximum ModCod (ModCod0 through ModCod11)</li> <li>Remote Demod Unlock Action: Maintain current ModCod Go to minimum ModCod</li> <li>Target Eb/No margin (0-4.5 dB, 0.5 dB steps)</li> </ul>
System Latency	54 ms max. (for a system operating at 100 ksps, and assuming a WAN buffer of 20 ms, not including satellite path)
Monitored Parameters	<ul style="list-style-type: none"> <li>Tx and Rx ModCods</li> <li>Local and Remote SNR (-3.0 to +22.0dB, 0.1dB resolution, <math>\pm 0.5</math> dB accuracy)</li> <li>Config and monitor menus displaying data rate, modulation and code rate update dynamically with ModCod</li> </ul>
List of ModCods	See Appendix B, Table B-3

### 1.3.7.2 VersaFEC-2 ACM (V2-ACM)

System Type	Adaptive Coding and Modulation, using BPSK, QPSK, 8-ARY, 16-ARY, 32-ARY and VersaFEC-2 Short-block and Long Block LDPC coding - total of 74 ModCods
Symbol Rate Range	37.0 ksps to 3.0 Msps for the Long block. However, the Short block is limited to 2.0 Mbps (CCM) and 1.0 Msps (ACM).
Interface	10/100 Base T Ethernet, with auto-negotiated Congestion Control
Remote SNR Reporting	Automatically reported from remote modem – built in function at the physical layer – requires no additional overhead
Max Span of Data Rate	9:1 over range of adaptation
Switch Point (decreasing SNR)	Corresponds to SNR ( $E_s/N_0$ ) that gives BER = $1 \times 10^{-8}$ (margin set to 0 dB)
Switch Point Hysteresis	0.3 dB
Max Fading Rate	Approximately 1 dB/second (higher if Target $E_b/N_0$ margin > 1 dB)
Max ModCod Update Rate	1 update every 1.7 seconds
Configurable Parameters	<ul style="list-style-type: none"> <li>• Maximum ModCod (ModCod00 through ModCod37, Long Block)</li> <li>• Maximum ModCod (ModCod00 through ModCod35, Short Block)</li> <li>• Remote Demod Unlock Action: Go to minimum ModCod</li> <li>• Target SNR margin (0 to 4.5 dB, 0.5 dB steps)</li> </ul>
System Latency @ 100 ksps	Long Block - 205 milliseconds max (not including WAN buffer or satellite path) Short Block – 40.4 milliseconds max (not including WAN buffer or satellite path)
Monitored Parameters	<ul style="list-style-type: none"> <li>• Tx and Rx ModCods</li> <li>• Local and Remote SNR (-3.0 dB to +22.0dB, 0.1dB resolution, +/- 0.5 dB accuracy)</li> <li>• Config and monitor menus displaying data rate, modulation and code rate update dynamically with ModCod</li> </ul>
List of ModCods	See Appendix B, Tables B-6 and B-7

### 1.3.8 Power

Parameter	Specification
AC Input Power	<b>CDM-570AL (L-Band):</b> <ul style="list-style-type: none"> <li>Without Optional Packet Processor, CnC, or BUC Power Supply: 29W typical, 32W maximum</li> <li>With Optional Packet Processor; without CnC or BUC Power Supply: 42W typical</li> <li>With Optional Packet Processor and CnC; without BUC Power Supply: 48W maximum</li> <li>With Optional Packet Processor, CnC, and 150W @50°C or 180W @30°C BUC Power supply: 250W (maximum)</li> </ul>
	<b>CDM-570A (70/140 MHz):</b> <ul style="list-style-type: none"> <li>Without Optional Packet Processor or CnC: 29W typical, 32W maximum</li> <li>With Optional Packet Processor; without CnC: 42W typical</li> <li>With Optional Packet Processor and CnC: 48W maximum</li> </ul>
	<b>Typical measured VA, Power Factor and Power Data:</b> <b>CDM-570AL (L-Band):</b> 240V 50 Hz Power Factor = 0.44, 65VA, 29W 110V 60 Hz Power Factor = 0.55, 50VA, 28W <b>CDM-570A (70/140 MHz):</b> 240V 50 Hz Power Factor = 0.33, 87VA, 29W 110V 60 Hz Power Factor = 0.53, 51VA, 28W
DC Input Power	<ul style="list-style-type: none"> <li>Without any option cards: 29W typical, 32W maximum</li> </ul>
Operating Voltage	<b>Standard AC Power Supplies CDM-570A (70/140MHz) or CDM-570AL (L-Band):</b> 100-240V AC, +6%/-10% – autosensing (total absolute max. range is 90-254V AC)
	<b>DC Power Supplies:</b> <ul style="list-style-type: none"> <li>(Optional) CDM-570A (70/140MHz) or CDM-570AL (L-Band): Modular -24V DC (range is 20-36V) or -48V DC (range is 43-60V)</li> <li>CDMR-570AL (L-Band): Terminal block -24V DC (range is 20-36V) or -48V DC (range is 43-60V)</li> </ul>

### 1.3.9 Physical Properties

Parameter	Specification
Dimensions	CDM-570AL (L-Band): 1RU high x 19 inches (482.6 mm) wide x 16 inches (406 mm) deep
	CDMR-570AL (L-Band): 1RU high x 19 inches (482.6 mm) wide x 11 inches (279 mm) deep
	CDM-570A (70/140 MHz): 1RU high x 19 inches (482.6 mm) wide x 13 inches (330 mm) deep
Weight	<b>CDM-570AL (L-Band):</b> <ul style="list-style-type: none"> <li>With TPC, CnC, no BUC: 7.2 lbs (3.27 kg)</li> <li>With TPC, CnC, 24V BUC: 8.2 lbs (3.70 kg)</li> <li>With TPC, CnC, 48V BUC: 8.4 lbs (3.81 kg)</li> </ul>
	CDMR-570AL: 6.9 lbs (3.12 kg)
	CDM-570A (70/140 MHz) (with TPC, CnC): 6.3 lbs (2.84 kg)
Operating Temperature	0 to 50°C (32 to 122°F)

### 1.3.10 Miscellaneous

Front Panel	Tactile keypad, 6 keys (Up/Down, Left/Right, Enter/Clear) Vacuum Fluorescent Display (blue) - 2 lines of 24 characters
Loopbacks	Internal IF loopback, RF loopback, digital loopback, and inward/outward loopback
Fault Relays	Hardware fault, Rx and Tx Traffic Alarms
M&C Interface	EIA-232 and EIA-485 (addressable multidrop, 2-wire or 4-wire)
Ethernet	10/100 Base Tx for http:, SNMP and Telnet interfaces
M&C Software	SatMac Ver. 4.7

### 1.3.11 Approvals

"CE" as follows:	EN 55022 Class B (Emissions) EN 50082-1 (Immunity) EN 60950 (Safety)	EN 61000-3-2 EN 61000-3-3 EN 61000-4-2 EN 61000-4-4 EN 61000-4-5	EN 61000-4-6 EN 61000-4-8 EN 61000-4-9 EN 61000-4-11 EN 61000-4-13
FCC	FCC Part 15 Class B		

# Chapter 2. INSTALLATION AND STARTUP

## 2.1 Unpack and Inspect the Shipment

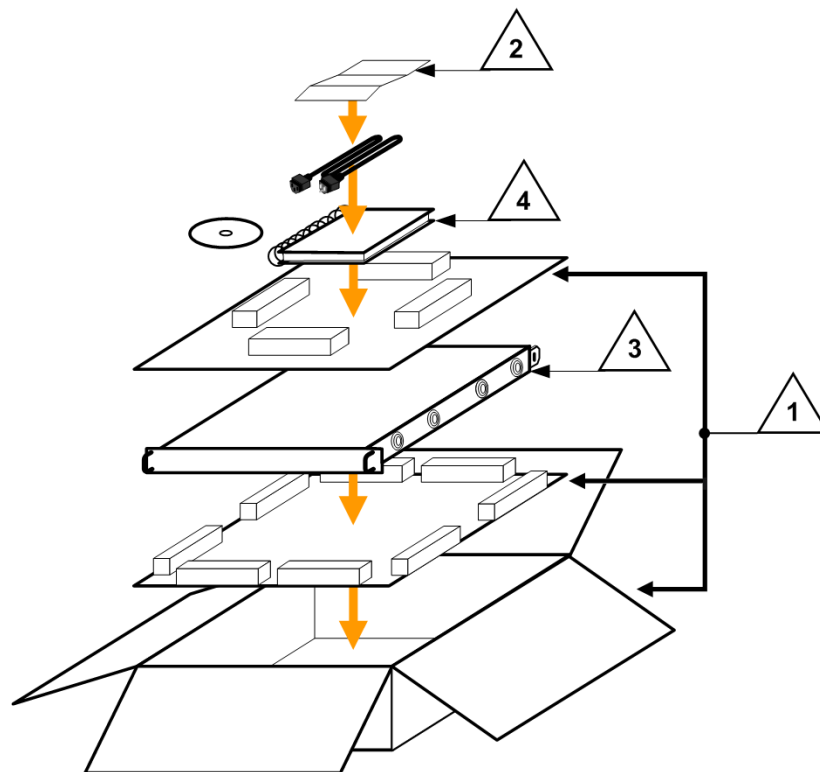

**Figure 2-1. Unpack and Inspect the Shipment**

The CDM-570A/570AL Satellite Modem, its optional Installation and Operation Manual (otherwise available online at <http://www.comtechefdata.com>), and its power cord were packaged and shipped in a reusable cardboard carton containing protective foam spacing (**Figure 2-1**).



**CAUTION – THIS EQUIPMENT CONTAINS PARTS AND ASSEMBLIES SENSITIVE TO DAMAGE BY ELECTROSTATIC DISCHARGE (ESD). USE ESD PRECAUTIONARY PROCEDURES WHEN HANDLING THE EQUIPMENT.**



Once opened, inspect the shipment:

Step	Task
1	Keep all shipping materials.
2	Check the packing list to make sure the shipment is complete.
3	Inspect the equipment for damage. If damage exists, immediately contact the carrier and Comtech EF Data to submit a damage report.
4	Read the manual.

## 2.2 Install the Modem into a Rack Enclosure

Install the modem in its assigned position in the rack enclosure (**Figure 2-2**).

Use, as required:

- A standard rack-mounted shelf;
- User-supplied screws to secure the front panel to the rack enclosure threaded front mounting rails;
- Comtech EF Data's optional KT/6228-2 (4") or KT/6228-3 (10") Rear Support Brackets Kit

For information about custom rack enclosures, contact Comtech EF Data Product Support.



- **CAUTION – PROPER GROUNDING PROTECTION IS REQUIRED TO PREVENT PERSONAL INJURY AND EQUIPMENT DAMAGE.** You must make sure the ground stud on the rear panel of the modem is always connected to the protective earth.
- **SUFFICIENT AIR VENTILATION IS REQUIRED:** The modem **CANNOT** have rack slides mounted to the sides of the modem. Cooling fans and exhaust vents are provided here – air flow must not be impeded.

**Make sure there is adequate air ventilation clearance inside the enclosure, especially at the sides. In a rack system where there is high heat discharge, provide forced-air cooling with top- or bottom-mounted fans or blowers.**

- **MAXIMUM AIR TEMPERATURE:** Make sure the air temperature inside the enclosure **never** exceeds 50°C (122°F).

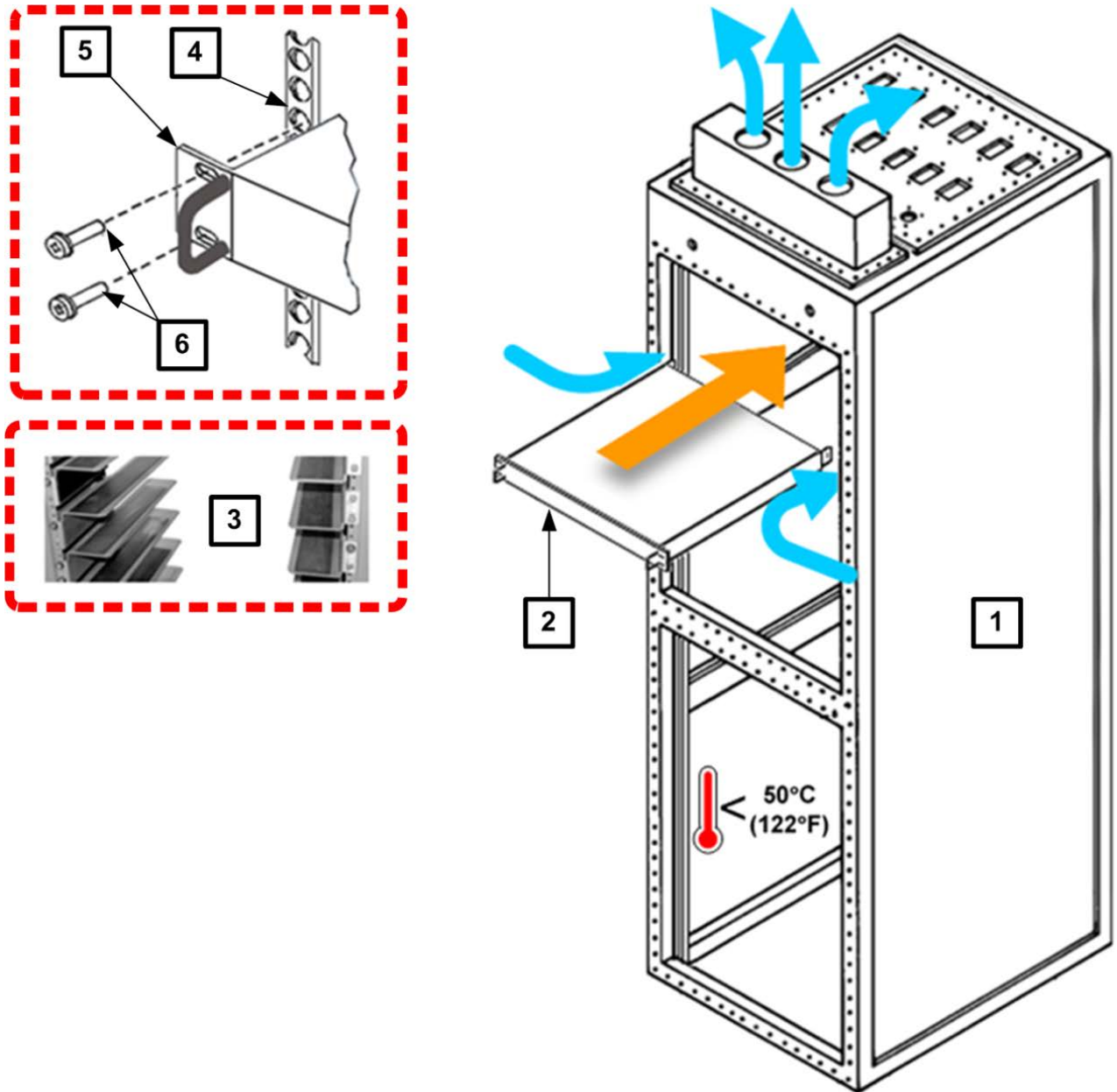

Feature	Description
1	Custom Rack Enclosure
2	CDM-570A/570AL Satellite Modem
3	Standard Rack Shelving
4	Rack Enclosure Threaded Front Rail (typical)
5	Modem Front Panel
6	User-supplied Screws

**Figure 2-2. Install the Modem into a Rack Enclosure**

## 2.2.1 Install the Optional Rear Support Brackets Kit

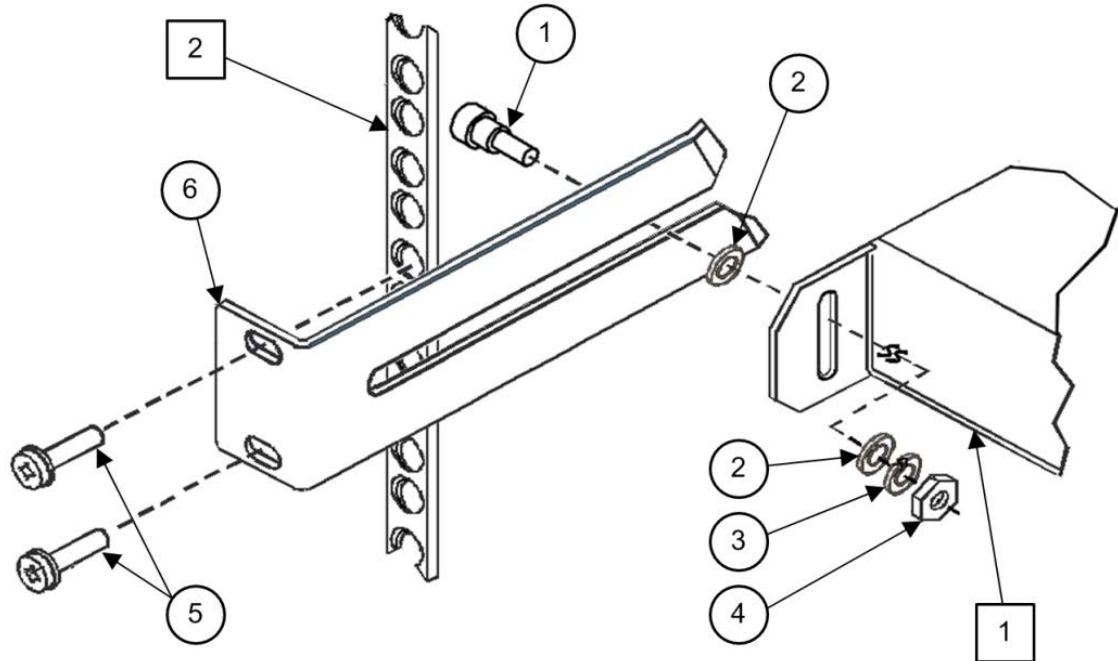

Detail	Description
1	Back of Modem
2	Rack Enclosure Threaded Rear Mounting Rail (typical)

Item	Kit / Quantity		Part Number	Description
	KT/6228-2	KT/6228-3		
1	2	2	HW/10-32SHLDR	Shoulder Screw, #10
2	4	4	HW/10-32FLT	Flat Washer, #10
3	2	2	HW/10-32SPLIT	Lock Washer, #10
4	2	2	HW/10-32HEXNUT	Hex Nut, #10
5	4	4	HW/10-32x1/2RK	Bolt, #10, Rear Support Bracket
6	2	-	FP/6138-2	Bracket, Rear Support - 4"
	-	2	FP/6138-3	Bracket, Rear Support - 10"

**Figure 2-3. Install the Optional Rear Support Brackets Kit**

The following tools are required to install the optional KT/6228-2 (4") or KT/6228-3 (10") Rear Support Brackets Kit:

- A medium Phillips™ screwdriver
- A 5/32-inch SAE Allen™ Wrench
- An adjustable Crescent™ wrench



Do these steps to install the kit (**Figure 2-3**):

1. Use the #10 flat washers, #10 split washers, and #10 hex nut to secure the #10 shoulder screws to the modem chassis through the rear right and left side mounting slots as shown.
2. Mount the Rear Support Brackets to the rack enclosure threaded rear mounting rails using the #10 Rack Bracket Bolts.
3. Slide the modem into the front of the rack enclosure. Make sure that the #10 Shoulder Screws properly engage into the slots of the Rear Support Brackets.

---

## 2.3 Configure the Modem

The modem ships with a default 64 kbps, QPSK, Rate 1/2 configuration. There are no internal jumpers to configure, no interface cards to install, and no other options to install. All configurations are carried out entirely via software.

Configure the modem locally using the front panel keypad and display. See **Chapter 6. FRONT PANEL OPERATION** for details on how to fully configure the modem for the desired operating parameters.



**The auto-sensing AC power supply does not require any adjustment. Simply plug in the supplied line cord, and then turn on the switch on the rear panel.**

---

## 2.4 Verify Operation (IF Loopback Test)

Verify proper operation of the modem, without the need for externally connected equipment by using the front panel keypad and display.

Do these steps:

1. From the top-level **SELECT:** menu: Use the ◀▶ arrow keys to first select the **TEST** menu branch, and then press **ENTER**.
2. From the **TEST** menu, use the ◀▶ arrow keys to first select **Mode**, and then **IF↓** (IF Loopback). Press **ENTER** to execute the test.



**See Chapter 6. FRONT PANEL OPERATION for detailed information on using Test modes.**

The demodulator should synchronize, and the Rx TRAFFIC LED indicator on the front panel should illuminate green. If the modem does not pass this test, contact Comtech EF Data Product Support for further assistance.

---

## 2.5 Connect the External Cables

Once the desired configuration settings have been made, and proper operation has been verified using the IF Loopback test mode, proceed to connect all external cables to the connectors outlined in the next chapter (**Chapter 3. REAR PANEL CONNECTORS AND PINOUTS**). Should difficulties occur, call Comtech EF Data Product Support for assistance.

# Chapter 3. REAR PANEL CONNECTORS AND PINOUTS

---

## 3.1 Overview – Cabling Connection Types

The CDM-570A/570AL and CDMR-570AL Satellite Modems, with or without the optional High-Performance Packet Processor, use a number of different cables. Each cable type is typically dedicated to a specific mode of operation.



1. **Not all of these operational interface types may be available.**
2. **The European EMC Directive (EN55022, EN50082-1) requires using properly shielded cables for DATA I/O. These cables must be double-shielded from end-to-end, ensuring a continuous ground shield.**

### 3.1.1 Coaxial Cable Connections

Figure 3-1 show the coaxial cables (plugs) and their mating connectors (jacks/sockets) that Comtech EF Data uses with their products: 'BNC', 'TNC', 'N', 'F', and 'SMA'.





Coupling Type	Connector Type	
	Plug (Male)	Jack (Female)
Bayonet (Type 'BNC' Shown)		
Threaded (Type 'N' Shown)		

Figure 3-1. Coaxial Connector Examples

These connectors are available in two coupling styles – **Bayonet** or **Threaded**:

- **Bayonet Coupling Style** – The jack has a pair of guideposts that accommodate the plug's lockdown slots. This lockdown design provides secure assembly without over-tightening the connection.
- **Threaded Coupling Style** – The jack features external threads. The plug shell features internal threads, and has either a knurled outer surface to permit hand-tightening of the connection, or hex flats to accommodate torqued installation.

#### Connection Instructions:

- **Bayonet Coupling Connections:** Use the plug slots to guide, then slide the plug onto the jack posts. Then, turn the plug clockwise until the jack posts are fully seated within the plug slot.
- **Threaded Coupling Connections:** Engage the plug onto the jack threads, and then turn the plug clockwise until it is fully threaded onto the jack. Do not over-tighten the connection.

---

### 3.1.1.1 Type 'BNC'

BNC connectors feature a **Bayonet Coupling** design.



---

### 3.1.1.2 Type 'TNC'

TNC connectors feature a **Threaded Coupling** design similar to Type 'N', Type 'F,' and Type 'SMA' connectors.



---

### 3.1.1.3 Type 'N'

Type 'N' connectors feature a **Threaded Coupling** design similar to Type 'TNC', Type 'F', and Type 'SMA' connectors.



---

### 3.1.1.4 Type 'F'

Type 'F' connectors feature a **Threaded Coupling** design similar to Type 'TNC', Type 'N', and Type 'SMA' connectors.



---

### 3.1.1.5 Type 'SMA' (Subminiature Version 'A')

Type 'SMA' connectors feature a **Threaded Coupling** design similar to Type 'TNC', Type 'N', and Type 'F' connectors.



### 3.1.2 D-Subminiature Cable Connections

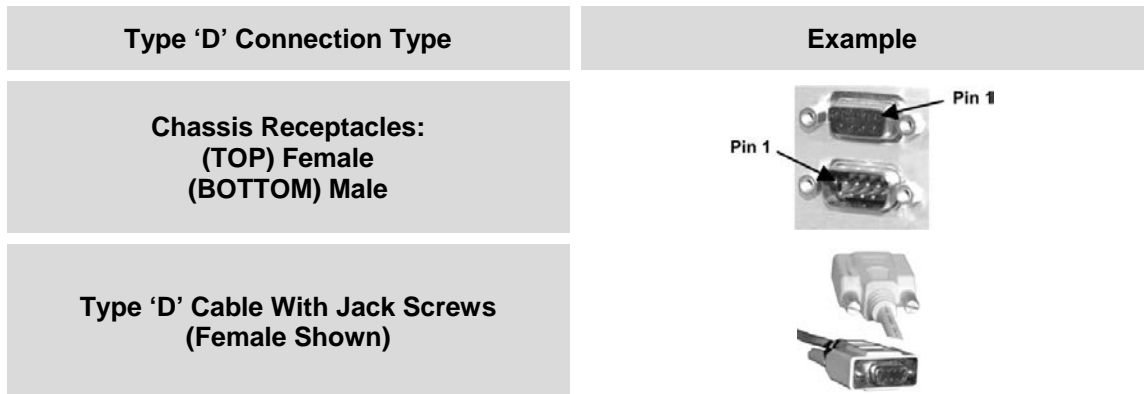

**Figure 3-2. D-Subminiature Connector Examples**

D-Subminiature connectors are also called **Type 'D'** or **'D-Sub'** connectors. The connector pair features multiple rows of pins (male side) coupled to mating sockets (female side). The cable plug and chassis receptacle each feature a D-shaped profile that interlock to ensure proper pin orientation and connector seating.

Either chassis receptacle gender features two jack nuts for secure assembly of the cable plug to the chassis receptacle.

Whether its gender is male or female, the cable plug features two jack screws for secure connection to the jack nuts provided on the mating chassis receptacle. The jack screws may be hand tightened or tightened with a standard flat-blade screwdriver.

**Connection Instructions:** Orient the plug to the receptacle in the proper position. Press firmly into place. Use the jack screws to secure the plug to the receptacle jack nuts. Do not over-tighten.

**About connector pinout tables:** **Figure 3-2** identifies the Pin 1 location for either gender connector. Unless noted otherwise, the connector pinout tables provided in this manual arrange/order information (i.e., the Pin # column/row) based on this orientation.

### 3.1.3 RJ-XX Cable Connections

The plug for an RJ-11, RJ-45, or RJ-48 cable features a flexible tab. The mating port features a slot to accept the tab. This design configuration assures proper installation and pin orientation.



**Connection Instructions:** Press down the tab on the cable plug, and then insert the plug into the port. The connection is complete when the tab 'clicks' in place inside the port.

### 3.2 Modem Cabling Connections

The modem rear panel connectors, shown here in **Figure 3-1** and summarized in **Table 3-1**, provide all necessary external connections between the modem and other equipment. See **Sect. 3.3** for information about the modem’s power and ground connections.



(TOP) Standard AC Chassis  
(MIDDLE) Optional -24V or -48V DC Chassis  
(BOTTOM) CDMR-570AL Reduced Chassis Depth Modem -24V or -48V DC Chassis

**Figure 3-3. Modem Rear Panel (CDM-570AL-IP Shown)**

**Table 3-1. Rear Panel External Cabling Connections**

Connector Group (Sect. Ref.)	Name	Connector Type	Function	
IF (Sect. 3.2.1)	Rx	CDM-570AL/CDMR-570AL: Type 'N' female	IF Input	
		CDM-570A: BNC female		
	Tx	CDM-570AL/CDMR-560AL: Type 'N' female	IF Output	
		CDM-570A: BNC female		
Terrestrial Data (Sect. 3.2.2)	Data Interface	25-pin Type 'D' female	Serial synchronous data Input/Output	
	G.703 Data	Balanced	15-pin Type 'D' female	G.703 T1 (1544 kbps) / E1 (2048 kbps)
		Unbalanced Out	BNC 75Ω female	Receive G.703 E1 (2048 kbps)
		Unbalanced In	BNC 75Ω female	Transmit G.703 E1 (2048 kbps)
	10/100 Ethernet	M&C 100	RJ-45 female	10/100 BaseT management and data
Traffic 100		RJ-45 female	(w/optional Packet Processor) Ethernet Traffic	
Utility (Sect. 3.2.3)	Remote Control	9-pin Type 'D' male	Serial Remote Interface (EIA-232/-485)	
	Alarms	15-pin Type 'D' male	Form C Alarms (relay closures)	
	1:1 Control	9-pin Type 'D' female	Connection to External 1:1 Controller	
	External Reference	BNC female	Input/Output	
	Console	RJ-11 female	(w/optional Packet Processor) EIA-232 Serial Console for Packet Processor management	

### 3.2.1 IF Connections Group



**CAUTION – THERE MAY BE DC VOLTAGES PRESENT ON THE TYPE ‘N’ RX AND TX IF CONNECTORS, UP TO A MAXIMUM OF 48 VOLTS.**

**CDM-570AL or CDMR-570AL:** The IF port connectors are both 50Ω ‘N’ female types. The return loss on these ports is greater than 17 dB (typically better than 20 dB). If there is a need to connect to a 75Ω system, you may use an inexpensive ‘N’ to ‘F’ type adapter. While there will be a reduction in return loss when doing this, the effect in most systems will be imperceptible.

**CDM-570A:** The IF port connectors are both BNC female types. The return loss on these ports is 17 dB minimum for *BOTH* 50Ω and 75Ω systems.

#### 3.2.1.1 Rx IF Connectors

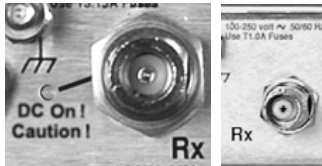

Connector Type	Description	Direction
CDM-570AL: Type ‘N’ (Shown at left)	Rx IF signal, L- Band	In
CDM-570A: BNC (Shown at right)	Rx IF signal, 70/140 MHz band	

#### 3.2.1.2 Tx IF Connectors

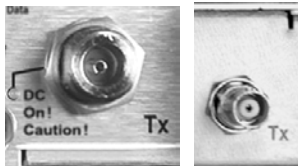

Connector Type	Description	Direction
CDM-570AL: Type ‘N’ (Shown at left)	Tx IF signal, L- Band	Out
CDM-570A: BNC (Shown at right)	Tx IF signal, 70/140 MHz band	



## 3.2.2 Terrestrial Data Connections Group

### 3.2.2.1 Data Interface Connector, DB-25F

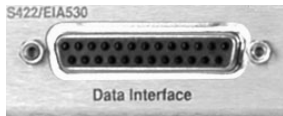

This 25-pin 'D' type female (DB-25F) Data Interface connector conducts data input and output breakout panel switching protection. This connector conforms to the EIA-530 pinout, which allows for connection of different electrical standards, including EIA-422, V.35, and EIA-232. Shielded connectors resolve EMC problems unlike sometimes-used V.35 Winchester connectors.



**THE MODEM IS ALWAYS ASSUMED TO BE DCE**



**Table 3-2. Data Interface Connector Pin Assignments**

Pin #	Generic Signal Description	Direction	EIA-422 EIA-530	V.35	EIA-232	Circuit #
2	Transmit Data A	DTE to Modem	SD A	SD A	BA	103
14	Transmit Data B	DTE to Modem	SD B	SD B	-	103
24	Transmit Clock A	DTE to Modem	TT A	SCTE A	DA	113
11	Transmit Clock B	DTE to Modem	TT B	SCTE B	-	113
15	Internal Tx Clock A	Modem to DTE	ST A	SCT A	DB	114
12	Internal Tx Clock B	Modem to DTE	ST B	SCT B	-	114
3	Receive Data A	Modem to DTE	RD A	RD A	BB	104
16	Receive Data B	Modem to DTE	RD B	RD B	-	104
17	Receive Clock A	Modem to DTE	RT A	SCR A	DD	115
9	Receive Clock B	Modem to DTE	RT B	SCR B	-	115
8	Receiver Ready A	Modem to DTE	RR A	RLSD	CF	109
10	Receiver Ready B	Modem to DTE	RR B	-	-	109
5	Clear to Send A *	Modem to DTE	CS A	CTS	CB	106
13	Clear to Send B *	Modem to DTE	CS B	-	-	106
4	Request to Send A *	DTE to Modem	RS A	RTS	CA	105
19	Request to Send B *	DTE to Modem	RS B	-	-	105
6	Data Set Ready A *	Modem to DTE	DM A	DSR	CC	107
22	Data Set Ready B *	Modem to DTE	DM B	-	-	107
7	Signal Ground	-	SG	SG	AB	102
1	Shield	-	Shield	FG	AN	101



1. This table is ordered by "Generic Signal Description" and not by connector pin orientation.
2. When the rear-panel switch marked "1:N Switch" is in the **OFF** position, all of the signals shown above are available and functional. In addition, pins not shown are not connected, and therefore no damage will occur if other signals are connected to the additional pins.
3. When the rear-panel switch marked "1:N Switch" is in the **ON** position, the highlighted signals, plus pins 18, 20, 21, 22, 23 and 25 are reserved for use by the 1:N system. **DO NOT** connect signals to any of these pins in this mode. Certain pins have DC voltages present that may damage equipment other than a Comtech EF Data redundancy switch.
4. For X.21 operation, use the EIA-422 pins, but ignore Receive Clock if the Modem is DTE, and ignore Transmit Clocks if the Modem is DCE.

### 3.2.2.2 10/100 Ethernet | Traffic 100 Port, RJ-45 (w/Optional Packet Processor only)



This 8-pin RJ-45 modular port is present only if the optional High-Performance Packet Processor is installed. Use a CAT5 cable to connect this port to an Ethernet hub, router, switch, PC, etc. for Ethernet data traffic, M&C of base modem and Packet Processor functions via Telnet/HTTP/ SNMP, and to update the Packet Processor firmware.

**Table 3-3. Typical Ethernet Port Pin Assignments**

Pin #	Function
1	Tx+
2	Tx-
3	Rx+
4	N/C
5	N/C
6	Rx-
7	N/C
8	N/C

### 3.2.2.3 G.703 Connections

#### 3.2.2.3.1 Unbal E1 Out/In G.703 Connectors (Tx/Rx), 75Ω BNC

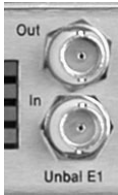

Two female 75Ω BNC connectors are provided for G.703 unbalanced operation at the E1 data rate (2.048 Mbps):

BNC Connector	Description	Direction
Unbal E1   Out	Rx G.703 (Unbalanced E1)	Out
Unbal E1   In	Tx G.703 (Unbalanced E1)	In

#### 3.2.2.3.2 Balanced E1/T1 G.703 Connector, DB-15F



This 15-pin 'D' type female (DB-15F) connector is used for G.703 balanced operation at the data rates of E1 (2.048 Mbps) or T1 (1.544 Mbps).

**Table 3-4. Balanced E1/T1 G.703 Connector Pin Assignments**

Pin #	Signal Function	Name	Direction
8	Not Used	---	---
15	Not Used	---	---
7	Not Used	---	---
14	Not Used	---	---
6	Not Used	---	---
13	Not Used	---	---
5	Not Used	---	---
12	Not Used	---	---
4	Ground	GND	---
11	Rx G.703 +	Rx G.703 Out	Out
3	Rx G.703 -	Rx G.703 Out	Out
10	Not Used	---	---
2	Ground	GND	---
9	Tx G.703 +	Tx G.703 In	In
1	Tx G.703 -	Tx G.703 In	In

### 3.2.2.3.3 G.703 RJ-48 Connection via Balanced E1/T1 Interface Connector

The optional CN-0000268 Adapter (**Figure 3-4**) is available for purchase from Comtech EF Data Product Support. Use this accessory to adapt the DB-15F Balanced E1/T1 G.703 interface connector to an RJ-48 female user interface.

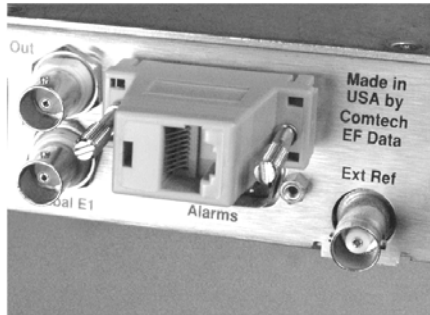

User Interface Side (RJ-48 F)

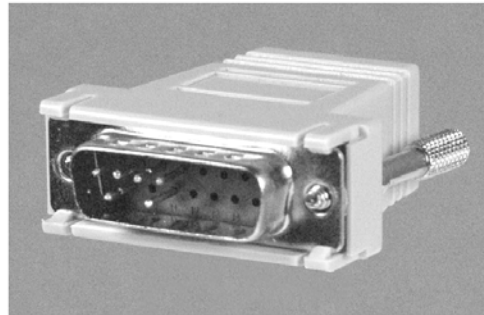

Modem Interface Side (DB-15M)

**Figure 3-4. CN-0000268 DB-15M → RJ-48F Adapter for Balanced E1/T1 G.703 Operation**

CN-0000268 Adapter Pin Assignments		
Signal Name	Pin #	
	RJ-48 (User Side)	DB-15M (Modem Side)
Tx+	1	9
Tx-	2	1
GND	3	2
Rx+	4	11
Rx-	5	3
GND	6	4



1. This table is ordered by "Signal Name" and not by connector pin orientation.
2. Pins 7 and 8 on the RJ-48 User Side and pins 5-8, 10, and 12-15 on the DB-15 Modem Side are **not used**.

### 3.2.3 Utility Connections Group

#### 3.2.3.1 10/100 Ethernet | M&C 100 Port, RJ-45 (Standard)



This 8-pin RJ-45 modular port is present on the base modem assembly. Use a CAT5 cable to connect this port to an Ethernet hub, router, switch, PC, etc. for M&C purposes and to update the base modem firmware.

See **Table 3-3** for the typical port pinouts.

#### 3.2.3.2 Remote Control Connector, DB-9M



Use this 9-pin type 'D' male (DB-9M) connector to connect the modem to an M&C computer, or terminal device. This interface is user-selectable for either EIA-232 or EIA-485.

**Table 3-5. Remote Control Connector Pin Assignments**

Pin #	Description	Direction
1	Ground	---
6	EIA-485 Receive Data B**	In
2	EIA-232 Transmit Data	Out
7	EIA-485 Receive Data A**	In
3	EIA-232 Receive Data	In
8	EIA-485 Transmit Data B	Out
4	Reserved - do not connect to this pin	---
9	EIA-485 Transmit Data A	Out
5	Ground	---



\*\*Use for EIA-485 2-Wire operation

#### 3.2.3.3 Alarms (Form-C Traffic Alarms) Connector, DB-15M



Use this 15-pin type 'D' male (DB-15M) connector to provide user access to the Form-C relay contacts that indicate the unit alarms/fault status. These contacts typically connect to the external fault monitoring system often found in satellite earth stations.

This connector also provides:

- The receive 'I' and 'Q' demodulator samples. Connecting these signals to an oscilloscope in X,Y mode will provide the receive signal constellation diagram, which is a useful diagnostic aid.
- A pin that can mute the transmit carrier; this requires that the pin be shorted to ground or a TTL 'low', or that an EIA-232 'high' signal be applied.
- An analog AGC signal (Pin 2) as an aid to antenna pointing or for driving step-track equipment.

**Table 3-6. Alarms Connector Pin Assignments**

Pin #	Signal Function	Name
1	Ground	GND
9	EXT Carrier OFF	EXT-OFF
2	AGC Voltage (Rx signal level, 0 to 10 volts)	AGC
10	No Connection	N/C
3	Rx Q Channel (Constellation monitor)	RX-Q
11	Rx I Channel (Constellation monitor)	RX-I
4	Unit Fault	UNIT-COM
12	Unit Fault (Energized, No Fault)	UNIT-NO
5	Unit Fault (De-energized, Faulted)	UNIT-NC
13	Tx Traffic	TX-COM
6	Tx Traffic (Energized, No Fault)	TX-NO
14	Tx Traffic (De-energized, Faulted)	TX-NC
7	Rx Traffic	RX-COM
15	Rx Traffic (Energized, No Fault)	RX-NO
8	Rx Traffic (De-energized, Faulted)	RX-NC

### 3.2.3.4 1:1 Control Connector, DB-9F



Use this 9-pin type 'D' female connector (DB-9F) to connect the modem **only** to a CRS-170A (L-Band) or CRS-180 (70/140 MHz) switch in 1:1 redundancy configurations.

**Table 3-7. 1:1 Control Connector Pin Assignments**

Pin #	Description	Direction
5	Ground	---
9	Fused +12 volt	Out
4	Redundancy In 2	In
8	Redundancy Out 2	Out
3	Redundancy In 1	In
7	Redundancy Out 1	Out
2	Receive Serial Data – auxiliary channel	In
6	Transmit Serial Data – auxiliary channel	Out
1	Ground	---

### 3.2.3.5 Ext Ref In/Out Connector, BNC



The Ext Ref In/Out connector is a BNC female connector. The signal here is user-supplied for phase-locking the internal 10MHz reference oscillator, and can be 1, 2, 5, 10 or 20 MHz. The impedance is matched for 50/75Ω, and requires a level in the range -6 to +10 dBm.

Connector Type	Description	Direction
BNC	External Reference	In/Out

### 3.2.3.6 Console Port, RJ-11 (w/Optional Packet Processor only)

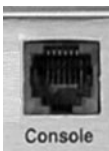

This asynchronous/serial 6-pin RJ-11 modular port is an EIA-232 DCE interface. You must use an adapter cable (e.g., CEFD P/N PL/9396-1, available for purchase from Comtech EF Data Product Support) to connect the User PC to this port, for operation of the Packet Processor Serial CLI (Command Line Interface).



**The CLI provides M&C of modem and Packet Processor functions via a user-provided terminal emulator (e.g., TeraTerm, PuTTY, or HyperTerminal). See Chapter 9. OPTIONAL PACKET PROCESSOR – SERIAL/TELNET CLI OPERATION**

**Table 3-8. Console Port Async-Serial Connection Pin Assignments**

Pin #	Function
1	Ground
2	Rx
3	Tx
4	Ground
5	Not used
6	Not used

### 3.3 Modem Ground, Power, and Fuse Connections

#### 3.3.1 Chassis Ground Interface



**CAUTION – CORRECT GROUNDING PROTECTION IS REQUIRED TO PREVENT PERSONAL INJURY AND EQUIPMENT DAMAGE.**

**THIS MODEM IS DESIGNED FOR CONNECTION TO A POWER SYSTEM THAT HAS SEPARATE GROUND, LINE, AND NEUTRAL CONDUCTORS. THE EQUIPMENT IS NOT DESIGNED FOR CONNECTION TO A POWER SYSTEM THAT HAS NO DIRECT CONNECTION TO GROUND. IT IS THEREFORE IMPERATIVE DURING INSTALLATION, CONFIGURATION, AND OPERATION THAT YOU PROPERLY GROUND THE MODEM USING THE GROUND STUD PROVIDED ON THE MODEM REAR PANEL AND THAT THE MODEM IS ALWAYS CONNECTED TO THE PROTECTIVE EARTH.**



(TOP) Standard AC Chassis

(MIDDLE) Optional -24V or -48V DC Chassis

(BOTTOM) CDMR-570AL Reduced Chassis Depth Modem -24V or -48V DC Chassis

Figure 3-5. Modem Chassis Ground Interface (CDM-570AL-IP Shown)

Use the #10-32 stud, located adjacent to the power interface module or terminal block, for connecting a common chassis ground among equipment.



The AC power interface provides the safety ground.



### 3.3.2 Standard Alternating Current (AC) Power and Fusing Interfaces

#### 3.3.2.1 AC Operation – Standard or Available Accessories

Contact Comtech EF Data Product Support to purchase any of these available accessories:

CEFD P/N	Description
PS-0000075	AC Primary Input Power Supply: 100-240 VAC, 65W
KT-0020593	AC Primary Input Power Supply Kit: 100-240 VAC w/required cables
KT/9640-3	L-Band BUC Power Supply: 24V DC 90 Watt (50° C) (100-240V AC Input)
KT-0000029	L-Band BUC Power Supply: 48V DC 150 Watt (50° C) (100-240V AC Input)
CA/17725	AC Power Cord, Standard (IEC-60320 Type C13) – USA
CA/90025-5FT	AC Power Jumper Cord, Standard (IEC-60320 Type C13)
KT/11633-1	AC Power Cord Retainer Kit (for any AC Cord)
CA/17850	AC Power Cord – European / French
CA/PWR83221	AC Power Cord – United Kingdom
WI/86516035-AUS	AC Power Cord – Australian / Chinese
PP-0000097	AC Power Cord – Japanese
PP-0020556	AC Power Cord – India

### 3.3.2.2 AC Operation – Chassis Power and Fusing

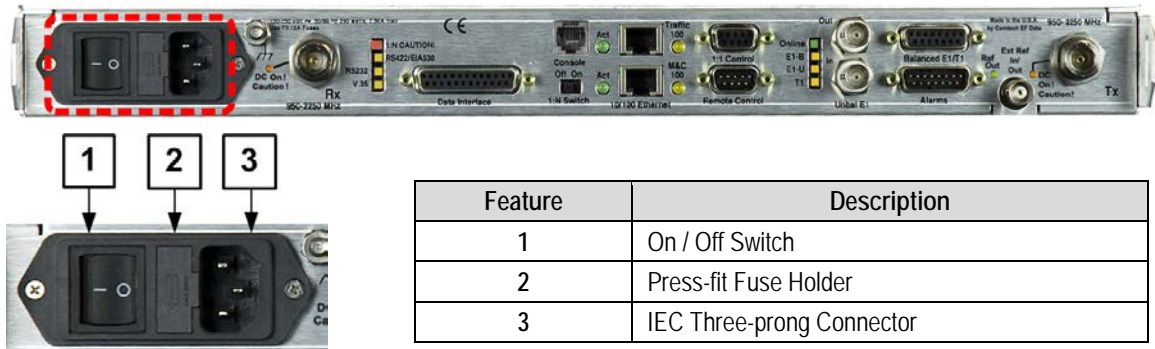

Feature	Description
1	On / Off Switch
2	Press-fit Fuse Holder
3	IEC Three-prong Connector

**Figure 3-6. Modem Standard AC Chassis (CDM-570AL-IP Shown)**

AC Power Specifications	
AC Consumption	<b>CDM-570AL L-Band:</b> <ul style="list-style-type: none"> <li>Without Optional Packet Processor, CnC, or BUC Power Supply: 29 Watts typical, 32 Watts maximum</li> <li>With Optional Packet Processor; without CnC or BUC Power Supply: 42 Watts typical</li> <li>With Optional Packet Processor and CnC; without BUC Power Supply: 48 Watts maximum</li> <li>With Optional Packet Processor, CnC, and 150 Watt @50°C, 180 Watt @30°C BUC Power supply: 250 Watts (maximum)</li> </ul>
	<b>CDM-570A 70/140 MHz:</b> <ul style="list-style-type: none"> <li>Without Optional Packet Processor or CnC: 29 Watts typical, 32 Watts maximum</li> <li>With Optional Packet Processor; without CnC: 42 Watts typical</li> <li>With Optional Packet Processor and CnC: 48 Watts maximum</li> </ul>
	<u>Typical measured VA, Power Factor and power data:</u> <b>CDM-570AL L-Band:</b> 240V 50 Hz Power Factor = 0.44, 65VA, 29 Watts 10V 60 Hz Power Factor = 0.55, 50VA, 28 Watts <b>CDM-570A 70/140 MHz:</b> 40V 50 Hz Power Factor = 0.33, 87VA, 29 Watts 110V 60 Hz Power Factor = 0.53, 51VA, 28 Watts
Operating Voltage	<b>Standard AC operation (CDM-570A or CDM-570AL only):</b> 100-240 volts AC, +6%/-10% – autosensing (total absolute max. range is 90-254 volts AC)
Modem Connector Type	IEC-60320 Type C14
Mating Connector	IEC-60320 Type C13
Fuse Protection	Use two (2X) 3.15A 5mm x 20mm Slo-Blo fuses for line and neutral fusing (115V AC operation). Fuses are contained within a fuse holder that is press-fit into the body of the IEC power module.

### 3.3.2.2.1 AC Operation – Apply Power

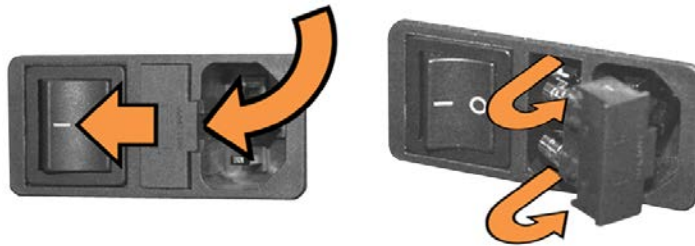

**Figure 3-7. Apply AC Power to the Modem**

Do these steps (**Figure 3-7**):

1. Plug the provided AC power cord female end into the modem.
2. Plug the AC power cord male end into the user-supplied power source.
3. Switch the unit ON.

### 3.3.2.2.2 AC Operation – Replace the Fuses



**Figure 3-8. Replace the AC Chassis Fuses**

Do these steps (**Figure 3-8**):



**WARNING! DISCONNECT THE POWER SUPPLY BEFORE PROCEEDING!**

1. Unseat the fuse holder from the IEC power module:
  - Use the slot to pry the holder outward from the module.
  - Pull the holder straight out, and then swing the holder away from the module.
2. Remove and replace the 3.15A 5mm x 20mm Slo-Blo fuses as needed for 115V AC operation.



**CAUTION – FOR CONTINUED OPERATOR SAFETY, ALWAYS REPLACE THE FUSES WITH THE CORRECT TYPE AND RATING.**

3. Reseat the fuse holder in the IEC power module.

### 3.3.3 Modem Optional -24V or -48V DC Power Interfaces

#### 3.3.3.1 Optional DC Operation – Available Accessories

Contact Comtech EF Data Product Support to purchase any of these available accessories:

CEFD P/N	Description
PS-0020503	-24V DC Primary Input Power Supply
PS-0020502	-48V DC Primary Input Power Supply
KT-0020656	-48V DC Primary Input Power Supply: w/required cables
KT/9640-5	L-Band BUC Power Supply: 24V DC 90W (50° C) (-48V DC Input)
KT/9640-6	L-Band BUC Power Supply: 48V DC 150W (50° C) (-48V DC Input)
KT-0020715	70/140 MHz AC to -48V DC Conversion Kit
KT-0020716	L-Band AC to -48V DC Conversion Kit
KT-0020717	70/140 MHz AC to -24V DC Conversion Kit
KT-0020718	L-Band AC to -24V DC Conversion Kit
KT-0020692	DC Primary Power Supply Kit: -48V DC, w/required cables
PS-0020519	DC 48V 120W Power Supply
PS-0020504	DC 24V 120W Power Supply
CA/WR10327-1	48V DC Power Cord
CA-0000455	DC Pigtail Adapter

### 3.3.3.2 Optional -24V or -48V DC Chassis Power and Fusing

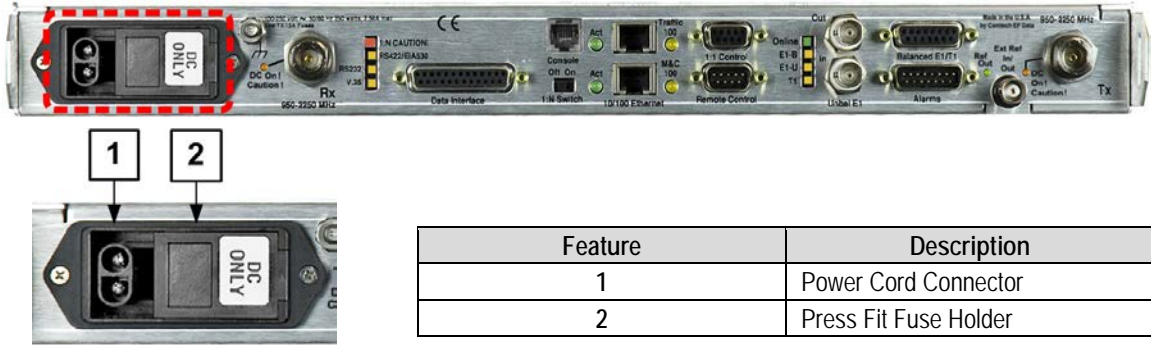

Figure 3-9. Modem Optional DC Chassis (CDM-570AL-IP shown)

DC Power Specifications		
Input Power	-48V	<ul style="list-style-type: none"> <li>Without optional Packet Processor or CnC: 29W typical, 32W maximum</li> <li>With optional Packet Processor, without CnC: 42W typical</li> <li>With optional Packet Processor and CnC: 48W maximum</li> </ul>
	-24V	
Input Voltage	-48V	48V DC nominal (43-60V)
	-24V	24V DC nominal (20-36V)
Modem Connector Type	Corcom PS series	
User Mating Connector	Corcom GA210 or Molex 03-12-1026	
Fuse Protection	Use two (2X) 20mm Slo-Blo fuses for positive and return fusing. Fuses are contained within a fuse holder that is press-fit into the body of the IEC power module: <ul style="list-style-type: none"> <li>Use T5.0A fuses for units without a BUC</li> <li>Use T8A fuses for units with a BUC</li> </ul>	

#### 3.3.3.2.1 Optional DC Operation – Apply Power

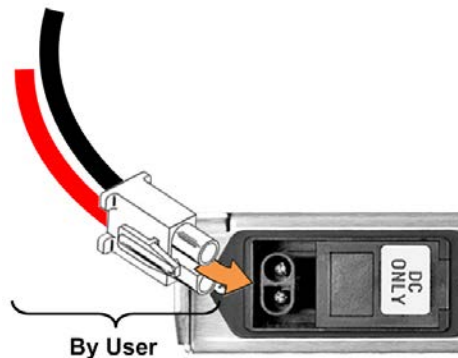

Figure 3-10. Apply Power to the Optional DC Chassis

Do these steps (**Figure 3-10**):



**WARNING! ENSURE THAT THE POWER IS REMOVED FROM THE DC CIRCUIT BEFORE PROCEEDING!**

1. Plug the user-supplied, male keyed DC power lead connector into the mating female connector until the lock tab engages. **Number 18 AWG minimum wires are recommended.**
2. Connect the user-supplied DC power leads to the power source.
3. Energize the DC power source to turn the modem ON.

### 3.3.3.2.2 Optional DC Operation – Replace the DC Power Fuses

For optional DC operation, the modem requires two *different* fuses that are contained within the press-fit fuse holder.

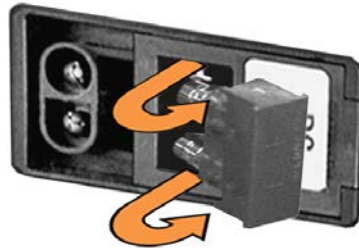

**Figure 3-11. Replace the Optional DC Chassis Fuses**

Do these steps (**Figure 3-11**):



**WARNING! DISCONNECT THE POWER SUPPLY BEFORE PROCEEDING!**

1. Unseat the fuse holder from the IEC power module:
  - Pry the holder outward from the module.
  - Pull the holder straight out, and then swing the holder away from the module.
2. Remove and replace the 20mm Slo-Blo fuses as needed.



**CAUTION – FOR CONTINUED OPERATOR SAFETY, ALWAYS REPLACE THE FUSES WITH THE CORRECT TYPE AND RATING.**

- Use T3.15A fuses for units without a BUC
  - Use T8A fuses for units with a BUC.
3. Reseat the fuse holder in the IEC power module.

### 3.3.3.3 CDMR-570AL Reduced Chassis Depth Modem -24 or -48V DC Power and Fuse

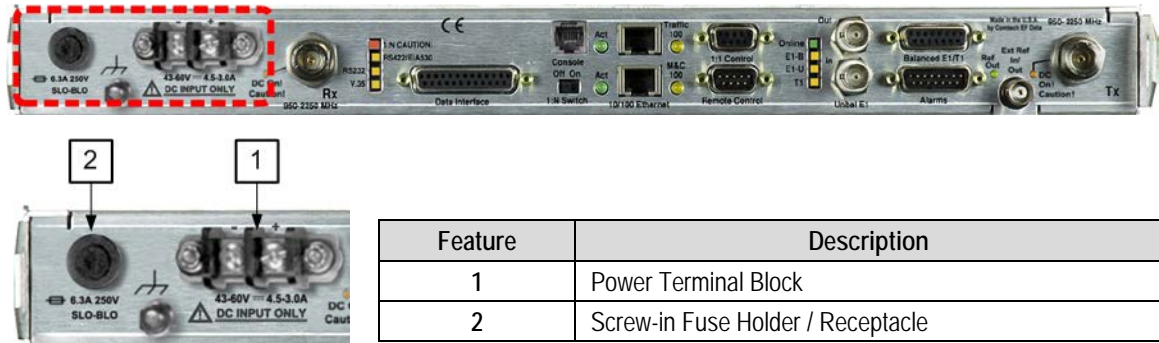

Feature	Description
1	Power Terminal Block
2	Screw-in Fuse Holder / Receptacle

Figure 3-12. CDMR-570AL Reduced Chassis Depth Modem -24 or -48V DC Power (CDMR-570AL-IP Shown)

DC Power Specifications (with CnC, without optional Packet Processor)		
Input Power	-48V	<ul style="list-style-type: none"> <li>Without optional Packet Processor or CnC: 29W typical, 32W maximum</li> <li>With optional Packet Processor, without CnC: 42W typical</li> <li>With optional Packet Processor and CnC: 48W maximum</li> </ul>
	-24V	
Input Voltage	-48V	48V DC nominal (43-60V)
	-24V	24V DC nominal (20-36V)
Connector Type	Terminal Block	
Fuse Protection	Use one (1X) TR5 6.3A 20mm Slo-Blo fuse for ALL units (with <i>or</i> without BUC). The fuse is contained within a screw-in receptacle located to the left of the terminal block.	

#### 3.3.3.3.1 CDMR-570AL – Apply DC Power

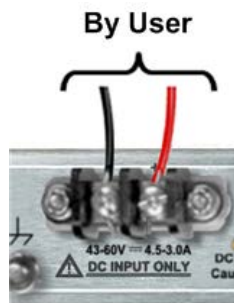

Figure 3-13. Apply DC Power to the CDMR-570AL

Do these steps (**Figure 3-13**):



**WARNING! ENSURE THAT THE POWER IS REMOVED FROM THE DC CIRCUIT BEFORE PROCEEDING!**

1. Use a screwdriver to affix the user-supplied DC power leads to their respective terminals. **Number 18 AWG minimum wires are recommended.**
2. Connect the user-supplied DC power leads to the power source.
3. Energize the DC power source to turn the modem ON.

### 3.3.3.4 CDMR-570AL – Replace the DC Power Fuse

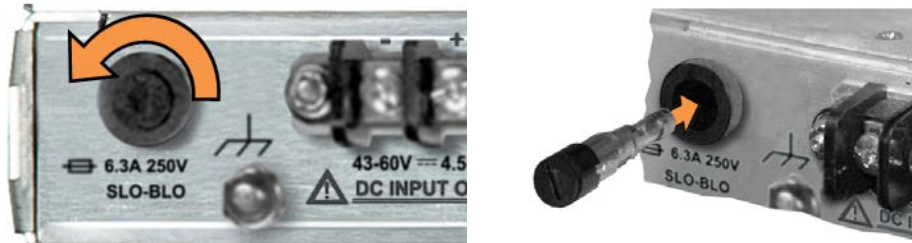

**Figure 3-14. Replace the CDMR-570AL DC Power Fuse**

The CDMR-570AL Reduced Chassis Depth Modem requires a single fuse that is contained within the screw-in receptacle that is located to the left of the terminal block.

Do these steps (**Figure 3-14**):



**WARNING! ENSURE THAT THE POWER IS REMOVED FROM THE DC CIRCUIT BEFORE PROCEEDING!**

1. Unscrew the fuse holder from its receptacle.
2. Remove and replace the modem fuse. Use a TR5 6.3A fuse (with **or** without a BUC).



**CAUTION – FOR CONTINUED OPERATOR SAFETY, ALWAYS REPLACE THE FUSE WITH THE CORRECT TYPE AND RATING.**

3. Screw the fuse holder back into its receptacle.



# Chapter 4. UPDATING FIRMWARE

---

## 4.1 Overview



1. **MAKE SURE to operate the CDM-570A/570AL with its latest available firmware.**
2. **Ethernet IP Functionality is available only when the cdm-570A/570AL is equipped with the optional HIGH PERFORMANCE Packet Processor.**

The CDM-570A/570AL Satellite Modem is factory-shipped with its latest version of operating firmware. If you need to update the modem firmware, you may download the update from the Comtech EF Data Web site ([www.comtecheffdata.com](http://www.comtecheffdata.com)). You may also receive the firmware update archive file via e-mail from Comtech EF Data Product Support.

You may perform the firmware update, without opening the CDM-570A/570AL, remotely over satellite (when the unit is equipped with the optional High Performance Packet Processor), or by directly connecting a user-supplied Microsoft Windows-based PC to the CDM-570A/570AL 'Ethernet 10/100 | M&C 100' port (for units without the optional Packet Processor) or the 'Ethernet 10/100 | Traffic 100' port (for units equipped with the optional Packet Processor).

In this order:

- Download the firmware update archive file via the Internet, or acquire the file from Comtech EF Data Product Support, and transfer the files to the User PC.
- Use Windows Command-line to transfer, via File Transfer Protocol (FTP), the extracted firmware files from the User PC to the CDM-570A/570AL standby firmware image.
- Use the CDM-570A/570AL front panel or the CDM-570A HTTP Interface to configure the modem to operate using the updated firmware image.

### 4.1.1 About Firmware Files, Naming, Versions, and Archive Formats

Comtech EF Data's Web site catalogues its firmware update files by product type (e.g., modem, converter, etc.) and specific model/optional configuration. For example, the Base Modem bulk firmware download hyperlink appears as **F0020683\*\_V###** (where '###' indicates the firmware version number, and '\*' is the revision letter of that version).

In addition to this Base Modem bulk firmware archive file, downloads are available for the CDM-570A/570AL's optional Packet Processor. Firmware updates are available from Comtech EF Data as follows:

Web Hyperlink	EXE/ZIP Filename	Contains Image File ( where '*' denotes revision letter and '#.#.#' or '#_#_#' denotes FW Version number)
F0020683*_V###	FW-0020683*	FW-0020683*_#.#.#.bin Base modem firmware
F0020781*_V###	FW-0020781*	FW-0020781*_CDM570A_PaP_#_#_#.bin Packet Processor Module option <u>without</u> 3XDES Encryption. (3XDES Encryption is a future offering.)

The firmware download files are available from Comtech EF Data in two archive file formats: **\*.exe** (self extracting) and **\*.zip** (compressed). Some firewalls will not allow the downloading of \*.exe files; in this case, download the \*.zip file instead. If applicable, one version prior to the current release is also available for download.



**For additional help with "zipped" file types, refer to the help files provided with the "PKZIP for Windows", "WinZip", or "ZipCentral" file archiving programs. "PKZIP for Command-line" is not supported due to file naming conventions.**

To verify the correct firmware number, see Step 1(d) in **Sect. 4.2.1 Getting Started: Prepare for the Firmware Download.**

## 4.2 Ethernet FTP Upload Procedure

### 4.2.1 Getting Started: Prepare for the Firmware Download

Do these steps:

1. First, identify the CDM-570A/570AL firmware (number/revision letter/version number) and the assigned Ethernet Traffic IP Address.

User-supplied items needed:

- A Microsoft Windows-based PC, equipped with available serial and Ethernet ports; a compatible Web browser (e.g., Internet Explorer); and a terminal emulator program (e.g., Tera Term, HyperTerminal, or PutTY).
- A 9-pin serial cable and a standard CAT5 Ethernet cable to connect the CDM-570A/ 570AL to the User PC.

- a. Use the 9-pin serial cable to connect the CDM-570A/570AL 'Remote Control' port to a serial port on the User PC.

Use an Ethernet hub, switch, or a direct CAT5 Ethernet cable connection to connect the User PC to the CDM-570A/570AL '10/100 Ethernet | M&C 100' port (for units without the optional Packet Processor) or the '10/100 Ethernet | Traffic 100' port (for units equipped with the optional Packet Processor).

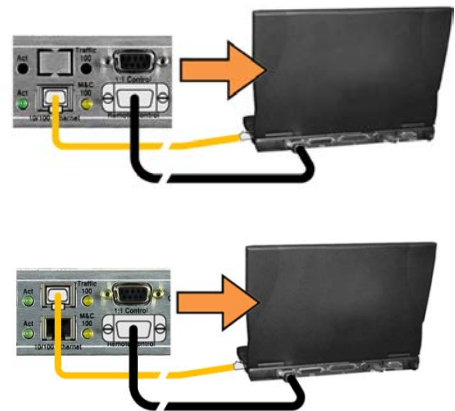

- b. **On the PC** – Open the terminal emulator program.



**Refer to your terminal emulator program HELP feature or user guide for operating and configuration instructions.**

Configure the utility program serial port communication and terminal display operation:

- 38400 bps (Baud Rate)
- 8 Data Bits
- 1 Stop Bit
- Parity=NO
- Port Flow Control=NONE
- Display New line Rx/Tx: CR
- Local Echo=ON

- c. **On the CDM-570A/570AL** – Turn on/connect the power source.



(LEFT) Standard CDM-570A/570AL AC Unit  
(RIGHT) Optional CDM-570A/570AL -48V DC Unit

- d. Identify the firmware information and Ethernet Traffic (M&C) IP Address using one of the following methods:



- Chapter 6. FRONT PANEL OPERATION
- Chapter 7. ETHERNET-BASED REMOTE PRODUCT MANAGEMENT
- Chapter 8. SERIAL-BASED REMOTE PRODUCT MANAGEMENT

Using the CDM-570A/570AL Front Panel menus:

- **Base Modem Firmware Info** – Use the **SELECT: UTIL → Firmware → Info → Image#1 or Image#2 → Bulk** menu branches, as shown in this example:

```
Bulk#1:           MM/DD/YY
FW-0020683*      #.#.#
```

- **Packet Processor Firmware Info** – Use the **SELECT: UTIL → Firmware → Info → PaP** menu branches, as shown in this example:

```
PaP:             MM/DD/YY
FW-0020781*      #.#.#
```

- **Ethernet IP Address** – Use the **CONFIG: Rem → Ethernet → Address** menu branch, as shown in this example:

```
Ether IP Address/Range:
192.168.001.011/24 ◀ ▶,▲▼
```

Using the CDM-570A HTTP Interface (via the User PC Web Browser – this assumes that you have already noted the Traffic/Management IP Address, which was previously required to open the CDM-570A HTTP Interface):

- **Base Modem Firmware Info** – Use the ‘Admin | Firmware | Modem’ page, as shown in this example:

Home	Admin	Configuration	Status	ODU	Redundancy					
Access	SNMP	Working Mode	PaP Features	Firmware	FAST	RADIUS	PaP Save	Reboot		
Modem	Packet Processor									

**Boot**

**Image 1**

- FW-0020683K, 1.5.1 ,09/13/16
- FW-0020685K, 1.5.1 ,09/13/16
- FW-0020686D, 1.3.1 ,07/26/16
- FW-0020687C, 1.3.1 ,05/09/16
- FW-0020688A, 1.2.1 ,05/03/16
- FW-0000516-, 1.1.1 ,19/01/11
- FW-0021041A, 1.3.1 ,06/22/16

**Image 2**

- FW-0020683K, 1.5.1 ,09/13/16
- FW-0020685K, 1.5.1 ,09/13/16
- FW-0020686D, 1.3.1 ,07/26/16
- FW-0020687C, 1.3.1 ,05/09/16
- FW-0020688A, 1.2.1 ,05/03/16
- FW-0000516-, 1.1.1 ,19/01/11
- FW-0021041A, 1.3.1 ,06/22/16

Currently running Image 2

Next Reboot, will use

- **Packet Processor Firmware Info** – Use the ‘Admin | Firmware | Packet Processor’ page, as shown in this example:

Home	Admin	Configuration	Status	ODU	Redundancy					
Access	SNMP	Working Mode	PaP Features	Firmware	FAST	RADIUS	PaP Save	Reboot		
Modem	Packet Processor									

**Firmware**

**Bootrom**

**Image 1**

**Image 2**

**Software Revision**

**Boot From**

**Upgrade To**

- **Ethernet IP Address** – Use the ‘Configuration | LAN’ page to view the IP Address/Mask, as shown in this example:

Home	Admin	Configuration	Status	ODU	Redundancy				
Modem	LAN	ARP	Routing	Managed Switch	WAN	Overhead	Utilities	BUC	LNB

**Network Configuration**

IP Address/Mask:  /       MAC Address:

Managed Switch Gateway IP:       Dedicated Management Port: **Disabled**

Traffic IP Address/Mask:  /       Traffic MAC Address:

Traffic IP Applicable For Dedicated Management/Redundancy Feature Only

**Using the CDM-570A/570AL Serial Remote Interface (via the User PC / terminal emulator program):**

- **Firmware Info** – Use the **<0/SWR?** (condensed) or **<0/FRW?** (detailed) remote query.
- **Ethernet Traffic IP Address** – Use the **<0/IPA?** remote query.

2. Next, create a temporary folder (subdirectory) on the User PC for the firmware archive download.



- **Drive letter “c:” is used in these examples. Any valid, writable drive letter can be used.**
- **Typical for all tasks: Type the command without quotes, and then press Enter to execute.**

There are several ways to create a temporary folder on a Windows-based PC:

- Use the Windows Desktop to create and rename the temporary folder.
  - Right-click anywhere on the desktop to open the popup submenu, and then select **New > Folder** to create a temporary folder on the desktop.
  - Right-click on the new folder and then select **“Rename”** from the popup submenu. Rename this folder to **“temp”** or some other convenient, unused name.

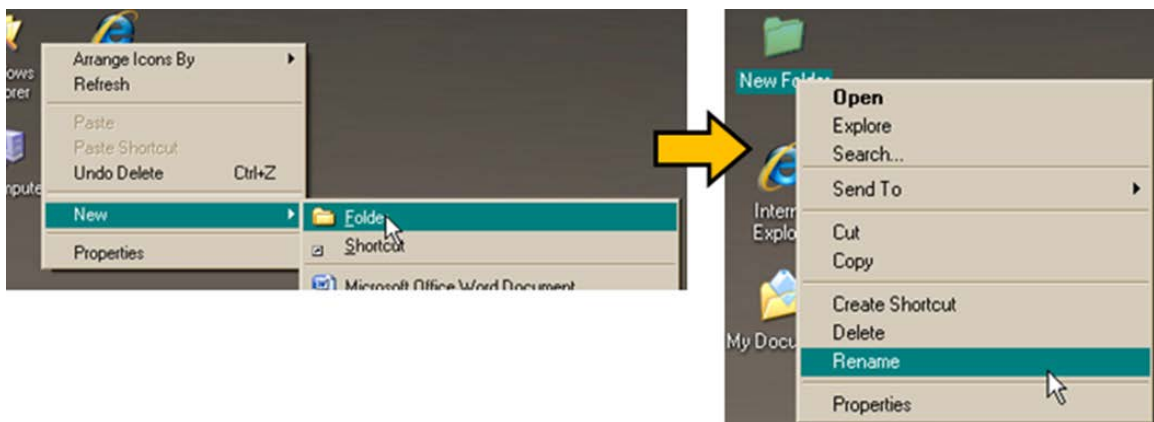

**b. Use Windows Explorer to create and rename the temporary folder.**

- Select **File > New > Folder** to create a temporary folder. This creates the new folder in the active folder.
- Right-click the **"New Folder"** folder name, and then rename this folder to **"temp"** or some other convenient, unused name:

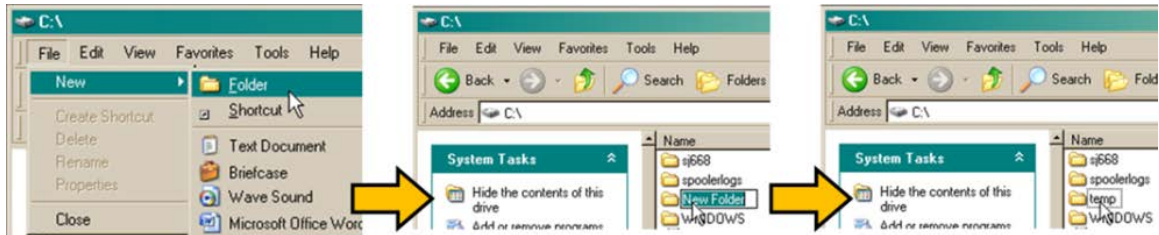

**c. Use the 'Run' and 'Browse' windows to create and rename the temporary folder.**

- Select **[Start]** on the Windows taskbar, and then click the **Run...** icon. This opens the 'Run' window.
- Click **[Browse]** in the 'Run' window. This opens the 'Browse' window.
- Click the **Create New Folder** icon in the 'Browse' window. This creates the new folder.
- Right-click the **"New Folder"** folder name, and then rename this folder to **"temp"** or some other convenient, unused name:

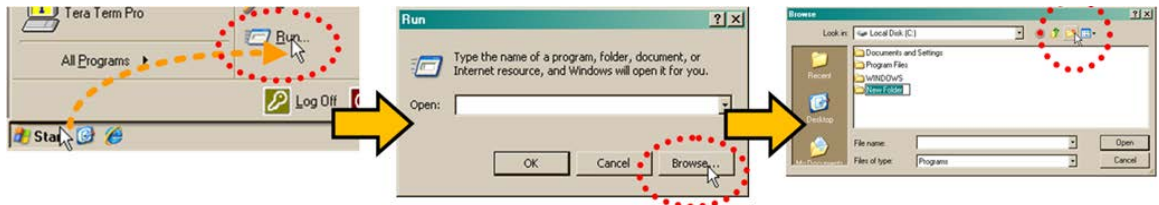

**d. Use Windows Command-line to create the temporary folder.**

- First, click **[Start]** on the Windows taskbar, and then click the **Run...** icon (or, depending on Windows OS versions prior to Windows 95, click the **MS-DOS Prompt** icon from the **Main Menu**).
- Next, open a **Command-line window...**
  - For Windows 95 or Windows 98, type **"command"** (or, for any Windows OS versions later than Windows 98, type **"cmd"** or **"command"**):

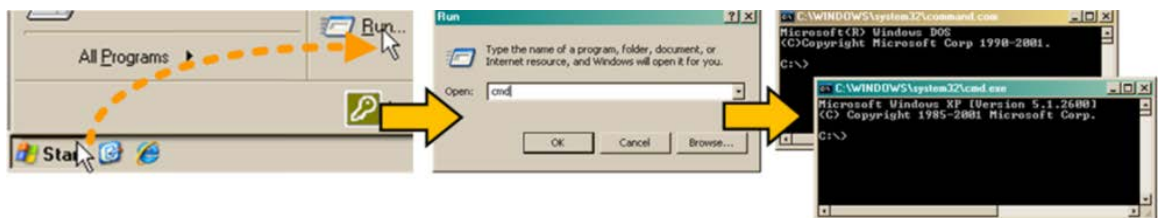

- Alternately, from **[Start]**, select **All Programs > Accessories > Command Prompt**.
- Finally, from the Command-line prompt (c:\>), type **"mkdir temp"** or **"md temp"** (**mkdir** and **md** stand for **make directory**), and then click **[OK]**:

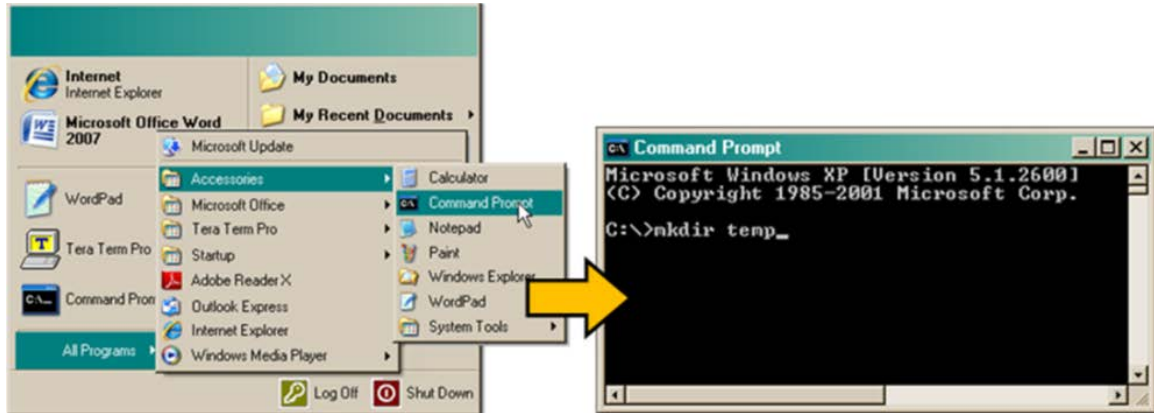

There should now be a "temp" folder created and available for placement of the firmware file download.

## 4.2.2 Download and Extract the Firmware Update

Do these steps:

1. First, download the firmware update file from the Comtech EF Data Web site:
  - a. Go online to [www.comtechefdata.com](http://www.comtechefdata.com).
  - b. On the **Main** page – under Support Information or the Support tab, select the **Software Downloads** hyperlink.
  - c. On the **Software Downloads** page – click **Download Flash and Software Update Files**.
  - d. On the **Flash & Software Update Files** page – select the **(Select a Product Line) Satellite Modems** hyperlink.
  - e. On the **Satellite Modems** product page – select the **CDM-570A & CDM-570AL** products hyperlink.
  - f. Select the appropriate firmware archive EXE or ZIP file download hyperlink.



### Sect. 0 About Firmware Numbers, File Versions, and Formats

- g. Download the archive file to the temporary folder.
  - Once the EXE or ZIP hyperlink is selected, the **'File Download'** window opens and prompts selection of **[Open]** or **[Save]**:
    - Click **[Open]** to turn over file extraction to the user-supplied utility program. Be sure to extract the firmware files to the **"temp"** folder created earlier.



- Click **[Save]** to open the ‘**Save As**’ window. Be sure to select and **[Save]** the archive \*.exe or \*.zip file to the “**temp**” folder created earlier.
- Otherwise, click **[Cancel]** to quit and exit the file download process.



2. Next, extract the firmware files from the archive file.

- (If not already done with File Download > [Open]) Extract the firmware files from the downloaded \*.exe or \*.zip archive file with the user-supplied utility program:
  - Double-click on the archive file name, and then follow the prompts provided by the user-supplied utility program. Extract, at a minimum, two files:

For the Base Modem firmware update (where ‘\*’ is the revision letter and ‘#.#.#’ is the firmware version number):

- **FW-0020683\*\_#.#.#.bin** – the Firmware Bulk image file, and
- **CDM-570A\_FW-0020683\*\_ReleaseNotes\_v#.#.#.pdf** – the Firmware Release Notes PDF file.

For the Packet Processor firmware update (where ‘\*’ is the revision letter and ‘#.#.#’ is the firmware version number):

- **FW-0020781\*\_CDM-570A\_PaP\_#.#.#.bin**
- **CDM-570A\_PaP\_Release\_Notes\_v#.#.#.pdf** (or a variation of this filename, where ‘\*’ is the revision letter and ‘#.#.#’ is the firmware version).

3. Confirm availability of the firmware files in the temporary folder. There are several ways you may view the contents of the temporary folder on a Windows-based PC:

- a. From the Windows Desktop:
  - Double-left-click the “**temp**” folder saved to the Windows Desktop.
  - Use Windows Explorer to locate, and then double-left-click the “**temp**” folder.
  - Use the Browse window (**[Start]** > ...**Run** > **[Browse]**) to locate, and then double-click the “c:\temp” folder.
- b. Using Command-line:
  - Type “**cd c:\temp**” at the Command-line prompt to change to the temporary directory created earlier using Command-line.

- Type “dir” to list the files extracted to the temporary directory from the downloaded archive file.

The firmware files have been successfully downloaded and are now available for transfer to the CDM-570A/570AL.

### 4.2.3 Perform the Ethernet FTP Upload Procedure



Proceed with the firmware update procedure once the following items have been completed.

1. Verify the following items have been completed before doing the firmware update procedure.
  - The CDM-570A/570AL is connected to a user-supplied, Windows-based PC, and:
    - The PC serial port is connected to the CDM-570A/570AL “Remote Control” port with a standard user serial cable.
    - The PC Ethernet port is connected to the CDM-570A/570AL Packet Processor “10/100 Ethernet | Traffic 100” Ethernet port with a user-supplied hub, switch, or direct Ethernet cable connection.
    - The PC is running a terminal emulation program (for operation of the CDM-570A/570AL’s Serial Interface) and a compatible Web browser (for operation of the CDM-570A HTTP Interface).
  - The CDM-570A/570AL firmware and Ethernet Traffic/Management IP Address have been noted using either the CDM-570A/570AL’s Serial Interface or the CDM-570A HTTP Interface ‘Admin | Firmware | Base Modem’ / ‘Admin | Firmware | Packet Processor’ and ‘Configuration | LAN’ pages, respectively.
  - The latest firmware files have been downloaded or otherwise received from Comtech EF Data and are available on the User PC in an accessible temporary folder.
2. Modem redundancy features must be disabled prior to update.
3. When updating firmware on modems equipped with the Packet Processor, you must upload both the Base Modem and Packet Processor firmware files, and select the firmware slots prior to rebooting the modem.

Before you can transfer the firmware files from the User PC to the CDM-570A/570AL, you must first use Command-line to “ping” the modem to confirm proper connection and communication between the User PC and the modem:

- Type “ping xxx.xxx.xxx.xxx” at the Command-line prompt (where ‘xxx.xxx.xxx.xxx’ is the unit Ethernet Traffic/Management IP Address). The response should confirm whether the unit is properly connected and communicating.

You may proceed once you have verified User PC-to-Modem communications.

Do these steps:

1. Use Command-line to transfer (FTP) the files from the User PC to the CDM-570A/570AL:

- a. Type "**ftp xxx.xxx.xxx.xxx**" (where '**xxx.xxx.xxx.xxx**' is the CDM-570A/570AL Ethernet Traffic/Management IP Address).
- b. The Admin User Name and Password when prompted. The default User Name and Password is "**comtech**".
- c. Type "**bin**" to set the binary transfer mode.
- d. Type "**prompt**" and then "**hash**" to facilitate the file upload.
  - To begin the file transfer, transfer file **FW-0020683\*\_#.#.#.bin** (where '\*' is the revision letter and '#.#.#' is the version number):
    - If the Packet Processor is not installed:  
Type "**put FW-0020683\*\_#.#.#.bin a:\bulk.bin:**" to begin the file transfers – the destination "a:\bulk.bin" must be all lower case.
    - If the Packet Processor is installed:  
Type "**put FW-0020683\*\_#.#.#.bin**" (make sure you do **not** type the destination "a:\bulk.bin" as was done for the previous upload option).

For either option, it will take several minutes to transfer the file and update the firmware image.

e. Once the file transfers, Command-line displays the upload result, similar to:

**ftp: XXXXXXX bytes sent in XX.XXSeconds XXX.XXXKbytes/sec.**



**In the event you receive the "Connection closed by remote host." message, wait another minute before continuing. The firmware upload sometimes takes longer than the FTP client allows.**

f. Once the FTP upload is complete, as the upgrade process continues, the modem front panel displays:

**UPGRADING FIRMWARE  
Please Wait...**

The process sequences through several blocks – this will take several minutes. Once the update process is complete, the modem returns you to the previously active menu screen.

g. Type "**bye**" to terminate the FTP session, and then close the Command-line window.

2. Use the modem front panel menus, the CDM-570A HTTP Interface '**Admin | Firmware | Modem**' page, or issue the Serial Remote Interface **<0/SWR?** or **<0/FRW?** query, as shown previously, to verify that the PC-to-Modem FTP file transfer was successful.



If you are a Base Modem user, the CDM-570A/570AL is now operating with its latest firmware and you may skip to Step 6. However, if you are running a CDM-570A/570AL with the optional Packet Processor installed, do **NOT** reboot at this time – once you have uploaded the Base Modem firmware you must proceed to the next step (Step 3) to upload the Packet Processor firmware.

3. Before you can upload the Packet Processor firmware, you must first specify which firmware slot will receive the firmware update file transfer.
  - On the CDM-570A HTTP Interface 'Admin | Firmware | Packet Processor' page, use the 'Upgrade To' drop-down list to select **Latest**, **Image 1**, or **Image 2**.
  - Click [**Submit**] to save.

**Proceed once you have specified the file transfer destination slot.**

4. Use Command-line to initiate the FTP session with the modem.
  - a. Type "**ftp xxx.xxx.xxx.xxx**" (where '**xxx.xxx.xxx.xxx**' is the CDM-570A/570AL Ethernet Traffic/Management IP Address).
  - b. Enter the **Admin User Name** and **Password** to complete login.
  - c. Type "**bin**" to set the binary transfer mode.
  - d. Type "**prompt**", and then type "**hash**" to facilitate the file upload.
  - e. Type "**put FW-0020781\*\_CDM-570A\_PaP\_#\_#\_#.bin**" to begin the file upload.

It will take several minutes to transfer and write the files to flash memory. Once the file transfers, Command-line displays the upload result, similar to:

```
200 Port OK
150 Opening data connection
226 Packet Processor upgrade complete - Safe to reboot.
ftp: XXXXXXXX bytes sent in X.XXSeconds XXXX.XXXbytes/sec.
```

- f. Once the FTP upload is complete, as the upgrade process continues, the modem front panel displays:

**IP OPTION CARD UPGRADING  
..PLEASE WAIT**

- g. The process sequences through several blocks – this will take several minutes. Once the update process is complete, the modem front panel displays:

**Upgrade finished  
Press CLEAR to continue.**

Press the modem front panel **CLEAR** key as prompted.

- h. Type "**bye**" to terminate the FTP session, and then close the Command-line window.

5. Use the modem front panel menus or the CDM-570A HTTP Interface '**Admin | Firmware | Packet Processor**' page to verify that the PC-to-Modem Packet Processor firmware FTP file transfer was successful.
6. Use the modem front panel menus and/or the CDM-570A HTTP Interface '**Admin | Firmware | Modem**' page and, as applicable, the '**Admin | Firmware | Packet Processor**' page to select the desired firmware images to boot from:
  - a. **Using the modem front panel menus:**
    - First, to select the desired Boot Image, make sure that you are operating in **LOCAL** mode (**CONFIG: Remote → Local**).
    - For the Base Modem firmware image, go to the **SELECT: Utilities → Firmware → Select** menu branch and use the **▲ ▼** arrow keys to select the **Next Reboot Image** as **1** or **2**. Press the front panel **ENTER** key when done.
  - b. **Using the CDM-570A HTTP Interface:**
    - For the Base Modem firmware, go to the '**Admin | Firmware | Modem**' page. Use the '**Next Reboot, will use**' drop-down list to select **Latest, Image#1** or **Image#2**. Click **[Submit]** to save.
    - For the Packet Processor firmware, go to the '**Admin | Firmware | Packet Processor**' page. Use the '**Boot From**' drop-down list to select **Latest, Image#1** or **Image#2**. Click **[Submit]** to save.
7. Reboot the CDM-570A/570AL. You may perform a 'soft reboot' or a 'hard reboot' as follows:
  - For a soft reboot, use the CDM-570A HTTP Interface '**Admin| Reboot**' page. Click **[Reboot Now]**. Both the web page and the modem front panel will display messages similar to "**Rebooting, Please wait...**" as reboot commences.
  - For a hard reboot, from CDM-570A/570AL rear panel, turn off or otherwise disconnect, and then turn on/reconnect the power source to execute reboot of the modem.

The system reboot is complete once the modem front panel displays the top-level "splash" screen:

```
Comtech CDM-570AL Modem
Firmware Version: #.#.#
```

Log in to a new Web session at this time. The CDM-570A HTTP Interface '**Home**' page will serve to verify that the new firmware version is active, as shown in this example:

Home	Admin	Configuration	Status	ODU	Redundancy	
Home	Contact	Support				



**CDM-570AL L-BAND Satellite Modem**

**Base Modem Firmware Version 1.5.1**

**Packet Processor Firmware Version 1.5.1c**

This web page interface is best viewed at **1152 x 864** resolution  
using **IE 7 to 10** on a 17" or larger monitor.

**The CDM-570A/570AL is now operating with its latest firmware. The firmware update process is now complete.**

# Chapter 5. FAST ACTIVATION PROCEDURE

---

## 5.1 Overview

The CDM-570A/570AL Satellite Modem incorporates a number of optional features. In order to permit a lower initial cost, you may purchase the unit enabled with only the desired features.

If you wish to upgrade the functionality of a unit at a later date, Comtech EF Data provides Fully Accessible System Topology (FAST), which permits the purchase and activation of options through special authorization codes. You may contact Comtech EF Data Product Support to purchase these unique, register-specific Fast Access Codes, and then load these codes into the unit using either the front panel keypad or the CDM-570A HTTP (Web Server) Interface.



**See Table 1-1 in Chapter 1. INTRODUCTION or Sect. 6.3.7.7.2 in Chapter 6. FRONT PANEL OPERATION for listings of the available FAST and FAST-accessible hardware options.**

**FAST System Theory:** FAST facilitates on-site upgrade of the operating feature set without removing a unit from the setup. FAST technology allows you to order a unit precisely tailored for the initial application. When your service requirements change, you can upgrade the topology of the unit to meet these requirements within minutes. This accelerated upgrade is possible because of FAST's extensive use of the programmable logic devices incorporated into Comtech EF Data products.

**FAST Implementation:** Comtech EF Data implements the FAST system in the modem at the factory. All FAST features are available through the basic platform unit at the time of order. You have the ability to "demo" all FAST features on a trial basis, for up to 30 days, through the Demo Mode that is available via the CDM-570A/570AL front panel or the CDM-570A HTTP Interface. FAST allows immediate activation of available options, after confirmation by Comtech EF Data, through the CDM-570A HTTP Interface.

**FAST Accessible Options:** You may order hardware options for installation either at the factory, or you can install and activate them on-site. The FAST Access Code that you purchase from Comtech EF Data enables configuration of the available hardware. The base CDM-570A/570AL unit is equipped with Viterbi codec. It offers BPSK, QPSK, and OQPSK modulation types, and data rates from 2.4 kbps to 512 kbps (FAST-upgradable to 10.24 Mbps). While it is limited to Closed Network operation, it also includes EDMAc and AUPC.

## 5.2 FAST Activation Procedure

### 5.2.1 FAST Activation via the Modem Front Panel



See Chapter 6. **FRONT PANEL OPERATION** for complete information about using this interface.

Do these steps:

1. Before you contact Comtech EF Data Product Support to order FAST feature upgrades, you must retrieve the modem's motherboard serial number:

- a. From the front panel main menu, **SELECT: FAST**, and then press **ENTER**.

The modem's 9-digit "Baseboard S/N" is displayed on the bottom line, to the left, as shown in this example:

```
FAST:Cnfg View (HW0.XXX)
MainBoard S/N: 123456789
```

- b. Write down the Serial Number: \_\_\_\_\_



**The MainBoard S/N (Serial Number) is a unique identifier for the FAST upgrade process and is different from the Chassis Serial Number.**

2. View the currently installed FAST features:

- a. From the front panel main menu (shown in Step 1A), use the ◀ ▶ arrow keys to select **View**, and then press **ENTER**.

- b. Use the ▲ ▼ arrow keys to scroll through the list of available FAST options. Options are identified as 'Y' (Installed) or 'N' (not installed) as shown in the following example:

```
View Options: 06 (▲ ▼)
TPC 0.95 Card Present Y
```

Any option labeled "N" may be purchased as a FAST upgrade.

3. Contact Comtech EF Data Product Support to order features:

- a. Provide the unit Serial Number to the Product Support representative.
- b. Identify and purchase the desired FAST option(s).
- c. Obtain the invoice, the **register-specific** 20-digit FAST Access Code(s), and the FAST option activation instructions.





When a FAST Access Code is obtained from Comtech EF Data, it will be for a specific option register. The FAST options are linked to two option registers:

- Register1 is for Data Rate, L-Band, and Framing options.
- Register2 is for Modulation type and Packet Processor options.

4. Activate your purchased FAST features.

- a. You must make sure you are active in the proper register. From the **SELECT: FAST** → **Cnfg** submenu, use the ◀ ▶ arrow keys to select **Edit Code**. Press **ENTER**.

```
Fast Configuration:
Edit Code  Demo Mode
```

Use the ▲ ▼ arrow keys to toggle Register 1 or 2.

```
Fast: Set register 2
00000000000000000000 ENT
```

- b. Next, use the ◀ ▶ arrow keys to jump to the bottom line. There, use the ▲ ▼ ◀ ▶ arrow keys to **carefully** enter each digit for your register-specific 20-character FAST Access Code.

Press **ENTER**. The modem responds with “**Configured Successfully**” if the **FAST** upgrade is accepted; the modem then resets to its newly-incorporated default configuration.

However, if an invalid code is entered, the following message displays:

```
Fast Code Rejected!
(ENTER or CLEAR)
```

Repeat the FAST Access Code entry procedure. Should the code entry error persist, contact Comtech EF Data Product Support for further assistance.

## 5.2.2 FAST Activation via the CDM-570A HTTP Interface



See Chapter 7. ETHERNET-BASED REMOTE PRODUCT MANAGEMENT for complete information about using this interface.

Home	Admin	Configuration	Status	ODU	Redundancy						
Access	SNMP	Working Mode	PaP Features	Firmware	FAST	RADIUS	PaP Save	Reboot			

**FAST code**

Register 1

Register 2

**Demo Time Remaining: 30 days 0 hours 0 minutes**  
(Please reboot the modem after enabling the demo mode.)

Demo Mode

Equipment ID	
Modem model number:	CDM-570AL
Serial Number:	100000000
Data Rate:	up to 10239kbps
Tx Roll Off Factor data rate:	up to 10239kbps
CnC data rate:	up to 10239kbps
Tx VersaFEC data rate:	up to 10239kbps
ACM symbol rate:	up to 3000ksps
<b>Options - Installed</b>	<b>Options - Not Installed</b>
Turbo Code Rate 0.95 Card Carrier-in-Carrier Card Expansion Card Packet Processor Card All TPC Code Rate Reed-Solomon Codec VersaFEC Codec VersaFEC-2 Codec Modulation: BPSK, (0)QPSK, 8QAM, 8-PSK, 16QAM, 8ARY, 16ARY, 32ARY	Fractional Carrier-in-Carrier BUC Power Supply

**Figure 5-1. CDM-570A HTTP Interface – Admin | FAST Page**

Use the CDM-570A HTTP Interface ‘Admin | FAST’ page (Figure 5-1) for complete management of FAST Features. This page provides FAST code entry/option activation control, and scrollable list boxes that display availability and activation status for all FAST options.

Do these steps:

1. Before you contact Comtech EF Data Product Support to order FAST feature upgrades, you must retrieve the modem’s motherboard serial number. Use the front panel **SELECT: FAST** menu, as explained in **Sect. 5.2.1 Step 1**, to obtain and record the modem’s motherboard serial number.

Write down the Serial Number: \_\_\_\_\_

2. Use the ‘Admin | FAST’ page to view the currently installed or available FAST features. Any options that appear in the scrollable **Options – Not Installed** list box may be purchased as a FAST upgrade.

3. Contact Comtech EF Data Product Support to order features:
  - a. Provide the unit Serial Number to the Product Support representative.
  - b. Identify and purchase the desired FAST option(s).
  - c. Obtain the invoice, the **register-specific** 20-digit FAST Access Code(s), and the FAST option activation instructions.



**When a FAST Access Code is obtained from Comtech EF Data, it will be for a specific option register. The FAST options are linked to two option registers:**

- **Register1 is for Data Rate, L-Band, and Framing options.**
- **Register2 is for Modulation type and Packet Processor options.**

4. Activate your purchased FAST features.
  - a. In the **FAST code** section of the '**Admin | FAST**' page, *carefully* enter the **register-specific** 20-character FAST Access Code into its designated text box (**Register 1** or **Register 2**) (each FAST Access Code is submitted separately). Click [**Submit**].
  - b. The message "**Configured Successfully**" appears at the top of the **FAST code** section if the **FAST** upgrade is accepted; the modem then resets to its newly-incorporated default configuration.

However, if an invalid code is entered, either of the following messages may appear instead:

FAST code has invalid format.  
It is 20-digit and consists of only 0-9 and A-F.

FAST code is not correct.

Repeat the FAST Access Code entry procedure. Should the code entry error persist, contact Comtech EF Data Product Support for further assistance.



# Chapter 6. FRONT PANEL OPERATION

## 6.1 Overview

**Figure 6-1** identifies the key features of the CDM-570AL/CDMR-570AL (L-Band) or CDM-570A (70/140 MHz) Satellite Modem front panels. The front panel features (from left) eight Light-Emitting Diode (LED) Indicators, a six-button keypad, and a Vacuum Fluorescent Display (VFD).

The LED Indicators, keypad, and VFD allow you to fully control and monitor the CDM-570A/ 570AL's operation. Refer to the pertinent chapter section for detailed information about the function and behavior of these features.

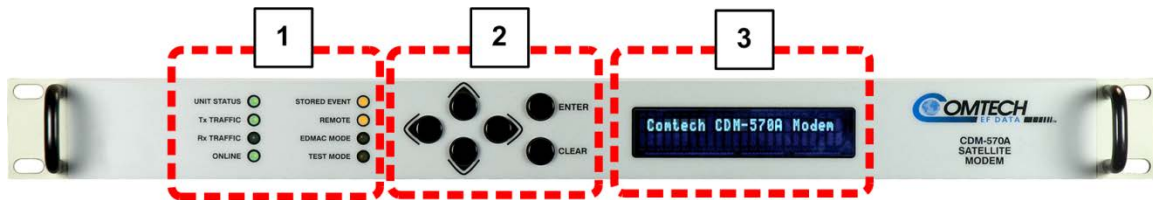

**Figure 6-1. Modem Front Panel Operation Features (CDM-570A shown)**

### 1 LED Indicators

The LEDs show a summary status of modem operation. See **Sect. 6.1.1**.

### 2 Keypad

The keypad has six individual keys. The keys have a positive 'click' action that gives tactile feedback. Use the keypad to enter data. See **Sect. 6.1.2**.

### 3 VFD

The VFD shows data, menus, prompts and messages. The VFD is an active display with adjustable brightness. It shows two lines of 40 characters each. Nested menus show all available options and prompts that guide you in carrying out required actions. See **Sect. 6.1.3**.

### 6.1.1 LED Indicators

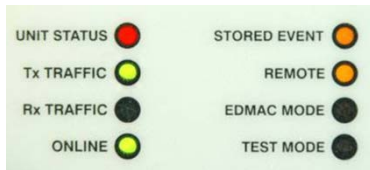

**In general, the alarm relay state reflects the state of the Front Panel LEDs. For example, if the Unit Status LED is red, the Unit Alarm relay is active. This does not apply to the Transmit Traffic relay, which activates only if a Tx Traffic Fault exists – it does not reflect the state of the Tx carrier.**

FRONT PANEL LED INDICATORS FUNCTIONAL DESCRIPTION		
LED	Condition	Description
UNIT STATUS	Red	A Unit Fault exists (Example: PSU fault)
	Orange	No Unit Faults, but a Traffic Fault, or ODU (BUC or LNB) fault exists
	Green	No Unit Faults, or Traffic Faults
Tx TRAFFIC	Green	No Tx Traffic Faults
	Off	A Tx Traffic fault exists OR the Tx Carrier is in OFF state
Rx TRAFFIC	Green	No Rx Traffic Faults (demod and Viterbi decoder are locked, everything is OK)
	Off	An Rx Traffic fault exists (the demod may still be OK – check the fault status of the modem from the Monitor menu).
ONLINE	Green	The modem is On Line, and carrying traffic
	Off	The modem is Off Line (standby) - forced by externally connected 1:1 or 1:N redundancy system
STORED EVENT	Orange	There is a Stored Event in the log, which can be viewed from the front panel, or retrieved via the remote control interface
	Off	There are no Stored Events
REMOTE	Orange	The modem is in Remote Mode - local monitoring is possible, but no local control
	Off	The modem is in Local Mode - remote monitoring is possible, but no remote control
	Flashing	ODU FSK control is enabled and there is a communications fault
EDMAC MODE	Orange	Framing on, EDMAC on, and unit defined as Slave - local monitoring is possible, but no local control
	Off	The modem is either in Transparent mode (no framing), or the framing is selected but in AUPC-only mode or EDMAC Master configuration
TEST MODE	Orange	A Test Mode is selected (Example: IF Loopback)
	Off	There is no Test Mode currently selected

### 6.1.2 Keypad



The keypad has an auto-repeat feature. When you hold down a key for more than 1 second, the key action repeats at the rate of 15 keystrokes per second. This is particularly useful when editing numeric fields with many numbers, such as frequency or data rate.

**ENTER key** – You may use the **ENTER** key as follows:

- From the opening screen, press **ENTER** once to go to the **SELECT: (main)** menu.
- Press **ENTER** to access the nested menu for a selected function, or to execute (save) a configuration change.

**CLEAR key** – You may use the **CLEAR** key as follows:

- From the opening screen, press **CLEAR** once to go to the **SELECT: (main)** menu.
- Press **CLEAR** to back out of a selection or to cancel a configuration change that you have not yet executed using **ENTER**.
- Press **CLEAR** to return to the previous menu screen.
- Press **CLEAR** repeatedly to return to the opening screen.

**◀▶ Left, Right keys** – On any menu screen, press the left or right key to move among available selections, or to move the cursor position

**▲▼ Up, Down keys** – Press the up or down key to scroll through settings that are available at the cursor position.

You may also use the up or down key to change the alphanumeric selection at the cursor position. Alphanumeric selections typically include numbers for configuration data and letters for text strings.

### 6.1.3 Vacuum Fluorescent Display (VFD)



The modem features a VFD, which is an active display showing two lines of 24 characters each. It produces a blue light with user-adjustable brightness. Compared to a LCD, it has greatly superior viewing characteristics and does not

suffer problems of viewing angle or contrast.

On most menu screens, a flashing solid block cursor blinks at a once-per-second rate. This indicates the currently selected item, digit, or field. Where it might obscure the item under edit (e.g., a numeric field), the solid block cursor automatically changes to an underline cursor.

### 6.1.3.1 Screen Saver

```
----- Unit Label --
any key.... Demod not lock
```

If you were to leave the operating unit displaying the same screen for weeks at a time, the VFD could become 'burnt' with this image. To prevent such burn-in, a screen saver feature activates after 1 hour. The screen saver message scrolls from right to left across the screen, and then wraps around. The user-configurable unit label, or Circuit ID, displays on the VFD top line, while the bottom line displays the demod lock state (i.e., 'Demod not locked' or the circuit  $E_b/N_0$  value if the demod is locked) and the prompt 'Press any key...' Press any key to return to the previous screen.

### 6.1.3.2 Opening Screen

The opening screen displays once you first apply power to the modem. Press **CLEAR** from any other nested menu until this screen appears. Press any other key to advance to the **Select:** (Main) menu screen.

When you disable the Internal Reference warm-up delay feature (see **Section 6.3.7.3.2**), depending on the modem type, one of the following screens displays:

**CDM/R-570AL(L-Band) unit:**

```
Comtech CDM/R-570AL Modem
Firmware Version #.#.#
```

**CDM-570A (70/140 MHz) unit:**

```
Comtech CDM-570A Modem
Firmware Version #.#.#
```

If, however, you enable the Internal Reference warm-up delay feature, one of the following screens displays:

**CDM/R-570AL(L-Band) unit:**

```
Comtech CDM/R-570ALModem
Ref Warming-up: 045
```

**CDM-570A (70/140 MHz) unit:**

```
Comtech CDM-570A Modem
Ref Warming-up: 045
```

The bottom line counts down, in seconds, the time remaining for the warm-up period. **During this period, the modem deliberately mutes the Tx Carrier.** At the end of the warm-up period, the bottom line reverts to the 'normal' opening screen display (i.e., it displays the modem Firmware version), and the modem **ENTERs** into its normal operational state.



**Bypass (override) the warm-up period at any time by pressing the CLEAR key.**



## 6.2 Compatible Mode Operation (CDM-570A/570AL vs. CDM-570/570L)

Certain features of the CDM-570A/570AL Satellite Modem are **not** backward compatible with the CDM-570 (70/140 MHz) and CDM/R-570L (L-Band) Satellite Modems. The CDM-570A/570AL provides a “compatibility mode” that is intended for use only in an existing network of CDM-570/570Ls.

**CDM/R-570AL (L-Band) unit:**

```
UTIL: Buf Clock Ref CMO
ID 1:1 VFD Firmware FAST
```

**CDM-570A (70/140 MHz) unit:**

```
Compatible Mode: CDM-570
CDM-570A (< >, ENT)
```

**To set up your CDM-570A/570AL Satellite Modem in CDM-570 Compatible Mode:** From the **SELECT: UTIL** menu branch, use the ◀▶ arrow keys to select **CMO**. Press **ENTER**. Then, use the ◀▶ arrow keys once again to set Compatible Mode as **CDM-570**. Press **ENTER**.



**Be sure to take the following operational conditions into consideration when using CDM-570 Compatible Mode operation:**

1. Use of CDM-570 Compatible Mode is required **ONLY** when the CDM-570A/570AL is a component in an existing network of CDM-570/570L modems. Otherwise, this mode should **NOT** be used, as it will make new (CDM-570A/570AL) features unavailable.
2. Certain features become disabled and unavailable, and the cursor skips over that selection, while the modem is set to CDM-570 Compatible Mode. For further information, see:
  - CONFIG: Tx → Pwr (Output Power Level Mode) → CnC-APC (Section F.6)
  - CONFIG: Tx → Inv → Clock (Tx Clock Invert) (Section 6.3.2.3.11)
  - CONFIG: Rx → Inv → Clock (Rx Clock Invert) (Section 6.3.2.4.10)
  - CONFIG: CnC (Carrier-in-Carrier) (Section 6.3.2.10)
  - SELECT: TEST → BERT (Section 6.3.4.2)
3. Certain feature options becomes disabled and unavailable, and the cursor skips over that option, while the modem is set to CDM-570 Compatible Mode. For further information, see:
  - CONFIG: Tx → FEC (VFEC, VF2L, VF2S, ULL) (Section 6.3.2.3.1)
  - CONFIG: Tx → α (Tx Alpha Filter Rolloff) (Section 0)
  - CONFIG: Rx → FEC (VFEC, VF2L, VF2S, ULL) (Section 6.3.2.4.1)
  - CONFIG: Rx → α (Rx Alpha Filter Rolloff) (Section 6.3.2.4.13)
4. Certain operational settings will reset to a default or fallback value when the modem is set to CDM-570 Compatible Mode. You must be sure to reconfigure the modem to your previously configured settings. For further information, see:
  - (CDM/R-570AL ONLY, above 2000 MHz) CONFIG: Tx → Frq (Section 6.3.2.3.5)
  - (CDM/R-570AL ONLY, above 2000 MHz) CONFIG: Rx → Frq (Section. 6.3.2.4.5)
  - CONFIG: Ref (Section 6.3.2.8)

### 6.3 Front Panel Operation

Figure 6-2 shows the hierarchal structure of the CDM-570A/570AL principle menu tree from the SELECT: menu on down.

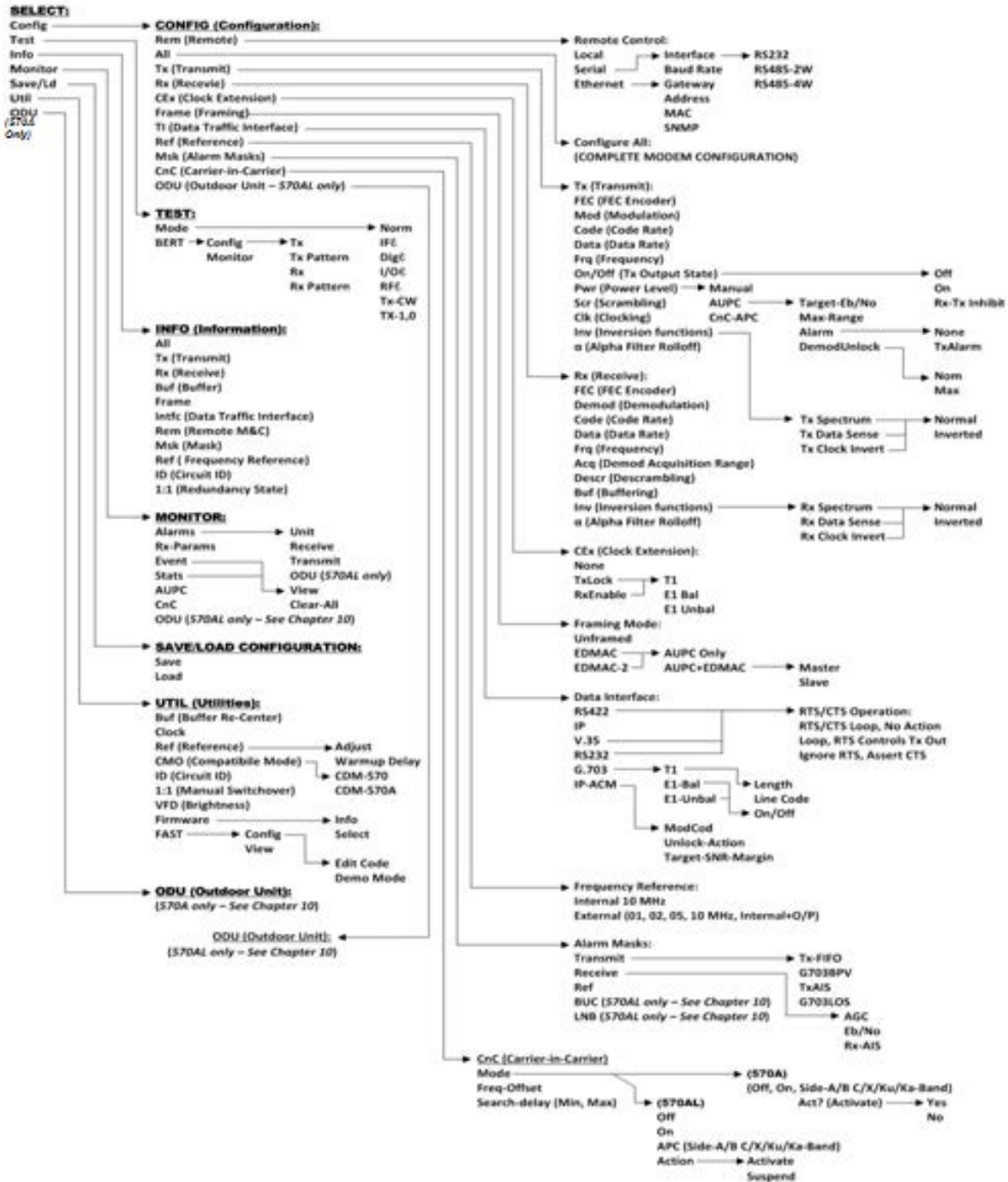

Figure 6-2. CDM-570A/570AL Principle Menu Tree

### 6.3.1 SELECT: (Main) Menu

**CDM-570AL/CDMR-570AL:**

**SELECT: Config Monitor  
Test Info Save/Load Util**

**CDM-570A:**

**SELECT: Config Test Info  
Monitor Save/Ld Util ODU**

Press **ENTER** or **CLEAR** to immediately access the **SELECT:** menu screen from the opening screen. From any nested menu, press **CLEAR** repeatedly until this screen reappears.

The table that follows identifies each menu branch available from the **SELECT:** menu and its content section in this chapter. Functionality of each menu sub branch is further explained in the subsequent chapter sections. Note that the selection order and naming differs between the two unit interfaces.

Menu Branch	Sect.	Function
Main	6.3.1	(Main) Menu
Config	6.3.2	(Configuration) Used to fully configure the modem.
Monitor	0	Used to monitor the current status of the modem and to view the log of stored events for the modem.
Test	6.3.4	Used to configure the modem into one of several test modes, and to configure/monitor the Bit Error Rate Tester (BERT).
Info	6.3.5	(Information) Used to view information on the modem, without having to access configuration screens.
Save/Load (CDM-570AL) Save/Ld (CDM-570A)	6.3.6	Used to save (store) or load (retrieve) up to 10 different modem configurations.
Util	6.3.7	(Utility) Used to perform miscellaneous functions, such as setting the real-time clock, adjusting the display brightness, etc.
ODU (CDM-570A, summary only)	0	(Outdoor Unit) For the CDM-570A only – Used to monitor and control a Comtech EF Data RF Transceiver (CSAT-5060 or KST-2000A/B), if connected. See Chapter 10. CDM-570A/570AL ODU (TRANSCEIVER, BUC, LNB) M&C OPERATIONS for full details.



**The actual choices that display in the submenus may vary according to which FAST options have been enabled. When a menu selection is dependent on the enabling of a FAST option, this is indicated in the descriptive text.**

Use the ◀ ▶ arrow keys to select a menu branch available from the top-level **SELECT:** menu. Press **ENTER** to continue.

### 6.3.2 (SELECT:) Config (Configuration) Menus



CDM-570AL/CDMR-570AL:

```
CONFIG: Rem All Tx Rx CEx
Frame TI Ref Msk CnC ODU
```

CDM-570A:

```
CONFIG: Rem All Tx Rx CEx
Frame TI Ref Msk CnC ◀ ▶
```

Use the ◀ ▶ arrow keys to select a submenu choice available from the **SELECT: Config** menu branch. Press **ENTER**.

Submenu	Sect.	Function
Rem	6.3.2.1	<b>(Remote Control)</b> Used to define whether the modem is being controlled locally, or remotely.
All	6.3.2.2	This submenu is highly recommended for new users, as it leads you through the complete modem configuration process on a step-by-step basis.
Tx	6.3.2.3	<b>(Transmit)</b> Used to define, on a per-parameter basis, the Tx configuration of the unit. These menu submenu branches would be used if you wished to change, for example, just the Tx Frequency..
Rx	6.3.2.4	<b>(Receive)</b> Used to define, on a per-parameter basis, the Rx configuration of the unit. These menu submenu branches would be used if you wished to change, for example, just the Rx data rate.
CEx	6.3.2.5	<b>(Clock Extension)</b> Used to define the G.703 Clock Extension interface.
Frame	6.3.2.6	<b>(Framing)</b> Used to define operation in a transparent mode (no framing) or in a framed mode. In the framed mode, an overhead of 5% or 1.6% is added to the rate transmitted over the satellite so that M&C and AUPC information may be passed to the distant end.
TI	6.3.2.7	<b>(Data Traffic Interface)</b> Used to define RS422, IP, RS232, V.35, G.703, or IP-ACM data traffic interfaces.  IP, VersaFEC ACM (IP-ACM), and VersaFEC-2 ACM (V2-ACM) are available only when the optional High-Performance Packet Processor is installed.
Ref	6.3.2.8	<b>(Reference)</b> Used to define whether the modem should use its own internal 10MHz reference, or phase lock to an externally applied reference and, if so, at what frequency.
Msk	6.3.2.9	<b>(Alarm Mask)</b> Used to mask certain alarms that may cause operational problems.
CnC	6.3.2.10	Used to select DoubleTalk Carrier-in-Carrier (CnC) options.  <b>Appendix G. DOUBLETALK CARRIER-IN-CARRIER (CNC)</b>
ODU (CDM-570AL, summary only)	6.3.2.11	<b>(Outdoor Unit)</b> For the CDM/R-570AL only – Used to configure a BUC (Block Up Converter) or LNB (Low-Noise Block Down Converter), if connected.  <b>Chapter 10. CDM-570A/570AL ODU (TRANSCEIVER, BUC, LNB) M&amp;C OPERATIONS</b>

### 6.3.2.1 CONFIG: Rem (Remote Control)

```
Remote Control: Local
Serial Ethernet (< >, ENTER)
```

Use the < > arrow keys to select a parameter. Press **ENTER**.



When you select **Local** mode, this disables remote control, although remote monitoring is still possible.

#### 6.3.2.1.1 (CONFIG: Remote Control) Serial



In **Serial** mode, in addition to enabling **Serial M&C**, this mode also allows **Telnet** connection, which enables **Telnet M&C** for modems configured for redundant operation.

When you select **Serial** from the **Remote Control** submenu and you do **not** define the modem as an **EDMAC SLAVE**, the modem displays the following menu:

```
Serial Config: Interface
Baudrate      (< >, ENTER)
```

#### (CONFIG: Remote Control) Serial: Interface

```
M&C Bus Interface: RS232
RS485-2W RS485-4W (< >)
```

Use the < > arrow keys to select a parameter. Press **ENTER**.

#### (CONFIG: Remote Control) Serial: Interface → RS232

The modem displays this **read-only** screen when you select **RS232**:

```
In RS232 Mode the Bus
Address is fixed at 0000
```

#### (CONFIG: Remote Control) Serial: Interface → RS485-2W or -4W

The modem prompts you to edit the bus address when you select either **RS485** mode:

```
RS485 Bus Address: 0245
(< >, ▲ ▼, ENTER)
```

The valid range of addresses is from **0001** to **9999**.

To edit the address, use the < > arrow keys to select a digit, and then use the ▲ ▼ arrow keys to change that digit. Press **ENTER**.

### (CONFIG: Remote Control) Serial: Baudrate

```
Local M&C Bus Baud Rate:  
19200 Baud (▲ ▼, ENTER)
```

Valid baud rates (in bps) are **2400, 4800, 9600, 19200, 38400, or 57600**.

Use the ▲ ▼ arrow keys to select the baud rate of the remote M&C bus that is connected locally to the User PC, bps. Press **ENTER**.



The asynchronous character format is **FIXED** at 8 data bits, 1 stop bit, no parity (8-N-1).

### 6.3.2.1.2 (CONFIG:) Remote Control: Ethernet



In Ethernet mode, Serial monitoring is allowed; however, Serial control is not allowed except for use of the LRS (Local/Remote Status) and FPL (Front Panel Lockout) commands and queries.

```
Ethernet Config: Gateway  
Address MAC SNMP (◀ ▶)
```

Use the ◀ ▶ arrow keys to select a parameter. Press **ENTER**.

### (CONFIG: Remote Control) Ethernet: Gateway

```
Ethernet IP Gateway:  
192.168.001.002 (◀ ▶, ▲ ▼)
```

To edit the modem 'M&C' Ethernet port IP Gateway Address, use the ◀ ▶ arrow keys to select a digit, and then use the ▲ ▼ arrow keys to change that digit. Press **ENTER**.

### (CONFIG: Remote Control) Ethernet: Address

```
Ether IP Address/Range:  
192.168.001.002/24 (◀ ▶, ▲ ▼)
```

To edit the modem 'M&C' Ethernet port management and data traffic IP Address and Range, use the ◀ ▶ arrow keys to select a digit, and then use the ▲ ▼ arrow keys to change that digit. Press **ENTER**.

### (CONFIG: Remote Control) Ethernet: MAC

```
M&C Port MAC Address:  
00-06-B0-00-01-06 (ENTER)
```

This **read-only** screen displays the unit MAC Address. Press **ENTER** or **CLEAR** to exit this menu.

**(CONFIG: Remote Control) Ethernet: SNMP**

```
SNMP: Communities Traps
      (< >, ENT)
```

Use the < > arrow keys to select a parameter. Press **ENTER**.

**(CONFIG: Remote Control) Ethernet: SNMP → Communities**

```
SNMP Communities:
Read Write      (< >, ENT)
```

Use the < > arrow keys to select a parameter. Press **ENTER**.

**(CONFIG: Remote Control) Ethernet: SNMP → Communities  
→ Read**

```
Read Community: (< >,▲ ▼)
public
```

**(CONFIG: Remote Control) Ethernet: SNMP → Communities  
→ Write**

```
Write Community: (< >,▲ ▼)
private
```

To edit the SNMP Read or Write Community strings, use the < > arrow keys to select a character to edit. Then, use the ▲ ▼ arrow keys to edit that character. Note that only the first 20 characters on the bottom line are available.

All printable ASCII characters are available with the exception of the backslash '/' (ASCII code 92) and tilde '~' (ASCII code 126).

Press **ENTER** once you compose the string – the modem removes all trailing spaces from the string upon entry.

**(CONFIG: Remote Control) Ethernet: SNMP → Traps**

```
Traps: Community Version
IP Addr#1 IP Addr#2 (< >)
```

Use the < > arrow keys to select a parameter. Press **ENTER**.

**(CONFIG: Remote Control) Ethernet: SNMP → Traps →  
Community**

```
Trap Community: (< >,▲ ▼)
comtech
```

To edit the SNMP Trap Read or Write Community strings, use the ◀ ▶ arrow keys to select a character to edit. Then, use the ▲ ▼ arrow keys to edit that character. Note that only the first 20 characters on the bottom line are available.

All printable ASCII characters are available with the exception of the backslash '/' (ASCII code 92) and tilde '~' (ASCII code 126).

Press **ENTER** once you compose the string – the modem removes all trailing spaces from the string upon entry.

### **(CONFIG: Remote Control) Ethernet: SNMP → Traps → Version**

```
Trap Version:
SNMPv1  SNMPv2  (◀ ▶, ENT)
```

Use the ◀ ▶ arrow keys to select the SNMP Trap Version as **SNMPv1** or **SNMPv2**. Press **ENTER**.

### **(CONFIG: Remote Control) Ethernet: SNMP → Traps → IP Addr#1 or Addr#2**

```
Trap IP #X:      (◀ ▶, ▲ ▼)
000.000.000.000
```

Where 'X' indicates Trap IP #1 or Trap IP #2: To edit the Trap Destination IP Address, use the ◀ ▶ arrow keys to select a digit, and then use the ▲ ▼ arrow keys to change that digit. Press **ENTER**.



**If you define both Trap IP Addresses as 000.000.000.000, this disables the Traps.**



---

### 6.3.2.2 CONFIG: All

Comtech EF Data highly recommends use of this menu branch for new users, as it allows step-by-step configuration of unit operations in their entirety.

Each configuration screen provides access to specific operations and their submenus. To execute:

- Use the ◀▶ and ▲▼ arrow keys as needed to select an operational submenu or to edit parameters on the active screen.
- Press **ENTER** to proceed to the next configuration screen.
- Press **CLEAR** to discontinue and return to the **CONFIG: All** menu.

The availability of configuration screens and related submenus is dependent on the active operational settings. For example, the first available configuration screen under **CONFIG: All** is the **Framing Mode** menu:

```
Framing Mode: Unframed
EDMAC  EDMAC-2 (◀ ▶,ENT)
```

If **Unframed** is the active setting and you press **ENTER**, the unit takes you to the next available configuration screen – **Data Interface**:

```
Data Interface: RS422 IP
V.35 RS232 G.703 IP-ACM
```

However, if **EDMAC** or **EDMAC-2** framing is active, the unit instead displays the nested **Framing Mix** menu:

```
Framing Mix: AUPC-only
AUPC+EDMAC (◀ ▶,ENTER)
```

In turn, selection of **AUPC+EDMC** from this submenu then displays the nested **EDMAC MODE: (Master/Slave)** menu. If **AUPC-only** is active, however, upon pressing **ENTER** the unit displays the **Data Interface** screen the next screen in this comprehensive configuration process (as shown previously).

### 6.3.2.3 CONFIG: Tx (Transmit)

```
Tx:FEC Mod Code Data Frq
On/Off Pwr Scr Clk Inv α
```

With VersaFEC ACM (IP-ACM) or VersaFEC-2 ACM (V2-ACM) modes selected:

```
Tx:FEC Mod Code Symb Frq
On/Off Pwr Scr Clk Inv α
```

Use the ◀ ▶ arrow keys to select a Tx setting. Press **ENTER**.

Parameter	Sect.	Description
<b>FEC</b>	<b>6.3.2.3.1</b>	(FEC) Select the method of FEC used for transmission (Viterbi, TPC, etc). FEC type takes the highest configuration priority.
<b>Mod</b>	<b>6.3.2.3.2</b>	(Modulation) Select the modulation type used for transmission (BPSK, QPSK, 8-PSK, etc.). The choice of modulation will depend on the FEC type chosen.
<b>Code</b>	<b>6.3.2.3.3</b>	(FEC Code Rate) Select the FEC Code Rate used for transmission (Rate 1/2, Rate 3/4, etc.). The choice of Code Rate will depend on both the FEC type and Modulation selected.
<b>Data</b>	<b>6.3.2.3.4</b>	(Data Rate) Select the transmit data rate, in steps of 1 bps. The choice of Data Rate will depend on the FEC type, Modulation, and Code Rate selected. <b>NOTE:</b> This parameter is not available when VersaFEC ACM (IP-ACM) or VersaFEC-2 ACM (V2-ACM) is selected.
<b>Symb</b>	<b>6.3.2.3.5</b>	(Symbol Rate) Used with VersaFEC ACM (IP-ACM) or VersaFEC-2 ACM (V2-ACM) modes only. When either ACM mode is active, the CONFIG: Tx menu changes the Data option to Symb.
<b>Frq</b>	<b>6.3.2.3.6</b>	(Frequency) Select the transmit frequency, in steps of 100Hz. <ul style="list-style-type: none"> <li>• CDM/R-570AL (L-Band) range: 950 MHz to 2250 MHz</li> <li>• CDM-570A (70/140 MHz) range: 50 to 90 MHz and 100 to 180 MHz</li> </ul>
<b>On/Off</b>	<b>6.3.2.3.7</b>	Select to control the output state of the transmit carrier.
<b>Pwr</b>	<b>6.3.2.3.8</b>	(Output Power level) Select to control the output level of transmit carrier, either manually or by using the AUPC (Automatic Uplink Power Control) feature.
<b>Scr</b>	<b>6.3.2.3.9</b>	(Scrambler) Select whether or not data scrambling is used.
<b>Clk</b>	<b>6.3.2.3.10</b>	(Clock Source) Select the clock source for transmission. This can be from the CDM-570AL's high stability internal source, from an external source, or from the distant-end of the satellite link (loop timed).
<b>Inv</b>	<b>6.3.2.3.11</b>	(Inversion) Set to invert the sense of the transmitted spectrum or transmitted baseband data.
<b>α</b>	<b>6.3.2.3.12</b>	Tx Alpha Filter Rolloff Factor dictates how fast the spectral edges of the carrier attenuate beyond the 3 dB bandwidth.



**VERY IMPORTANT NOTE** – The FEC type takes the highest configuration priority, and the selection here depends on what, if any, optional plug-in codecs are installed. The choice of FEC type then determines what modulation types, code rates, and data rates are available. The order of hierarchy is therefore:

**FEC type (Highest) ▶ Modulation type ▶ Code Rate ▶ Data Rate (Lowest)**  
When you change a parameter within this hierarchy, the other parameters may become invalid. In this case, the firmware changes those other parameters to ensure that the configuration remains valid at all times.

**Example:** Suppose you select Viterbi + Reed-Solomon, QPSK, Rate 1/2. Then, you change the modulation type from QPSK to 16-QAM. In this case, Rate 1/2 is no longer a valid code rate, and so it automatically changes to the nearest valid code rate (Rate 3/4).

### 6.3.2.3.1 (CONFIG: Tx) FEC (FEC Encoder Type)

```
TxFEC: Vit Vit-RS TCM-RS
TPC VF ULL VF2L VF2S Unc
```

With VersaFEC ACM (IP-ACM) mode selected:

```
Tx FEC: Fixed VFEC (ACM)
```

With VersaFEC-2 ACM (V2-ACM) mode selected, only VF2L or VF2S can be selected:

```
TxFEC: Vit Vit-RS TCM-RS
TPC VF Ull VF2L VF2S Unc
```



**IMPORTANT NOTE** – All selections are always viewable. If a Hardware or FAST option is either uninstalled or invalid, the cursor will skip past the unavailable choice.

The VFEC (VersaFEC), ULL (Ultra Low Latency), VF2L (VersaFEC-2 Long Block), and VF2S (VersaFEC-2 Short Block) Tx FEC types and their available Tx Modulation Types, Codes, and Data Rates are UNAVAILABLE when operating in CDM-570 Compatible Mode. If the Tx FEC Type is VFEC, ULL, VF2L, or VF2S when CDM-570 Compatible Mode is selected, then the Tx FEC Type will be reset to Viterbi and the Modulation and Code Rate will also be reset to appropriate values. See Section 6.2 for further information.

Tx FEC Encoder Selection	Available Tx Modulation Type	Available Tx Code Rate
Viterbi	BPSK	Fixed at 1/2
	QPSK	1/2, 3/4, 7/8
	OQPSK	
Vit-RS (Viterbi + Concatenated Reed-Solomon)	BPSK	Fixed at 1/2
	QPSK	1/2, 3/4, 7/8
	OQPSK	
	16-QAM (FAST)	3/4, 7/8
TCM-RS (Trellis Coded Modulation + Concatenated Reed-Solomon)	8-PSK (FAST)	Fixed at 2/3
TPC (Turbo Product Codec)	BPSK	5/16, 21/44
	QPSK	21/44, 3/4, 7/8, 0.95
	OQPSK	
	8-PSK (FAST)	3/4, 7/8, 0.95
	8-QAM (FAST)	
	16-QAM (FAST)	3/4, 7/8
VFEC (VersaFEC)	BPSK	Fixed at .488
	QPSK	.533, .631, .706, .803
	8-QAM (FAST)	.576, .642, .711, .780
	16-QAM (FAST)	.644, .731, .780, .829, .853
VF2L (VersaFEC-2 Long Block)	BPSK	0.489
	QPSK	0.489, 0.537, 0.586, 0.611, 0.635, 0.660, 0.684, 0.733
	8-ARY	0.521, 0.537, 0.562, 0.586, 0.611, 0.635, 0.660, 0.684, 0.708, 0.733
	16-ARY	0.586, 0.611, 0.635, 0.660, 0.684, 0.708, 0.733, 0.757, 0.782
	32-ARY	0.660, 0.684, 0.708, 0.733, 0.757, 0.782, 0.801, 0.831, 0.855, 0.879
VF2S (VersaFEC-2 Short Block)	BPSK	0.489
	QPSK	0.489, 0.537, 0.586, 0.611, 0.635, 0.660, 0.684, 0.733
	8-ARY	0.521, 0.537, 0.562, 0.586, 0.611, 0.635, 0.660, 0.684, 0.708, 0.733
	16-ARY	0.586, 0.611, 0.635, 0.660, 0.684, 0.708, 0.733, 0.757, 0.782
	32-ARY	0.660, 0.684, 0.708, 0.733, 0.757, 0.782, 0.801, 0.831
ULL (Ultra Low Latency)	BPSK	Fixed at .493
	QPSK	.493, .654, .734
Unc (Uncoded)	BPSK	Fixed at 1:1
	QPSK	
	OQPSK	

Use the ◀ ▶ arrow keys to select the FEC Encoder type. Press **ENTER**. Refer to the preceding table, the “Tx FEC Encoder Selection” which shows the “Available Tx Modulation Type” and “Available Tx Code Rate” choices.

### 6.3.2.3.2 (CONFIG: Tx) Mod (Modulation Type)

```
Modulation: BPSK QPSK
8-ARY 16-ARY 32-ARY
```

Use the ◀ ▶ arrow keys to select the Tx Modulation Type. Press **ENTER**. Refer to the table in **Section 6.3.2.3.1**, the “Tx FEC Encoder Selection” which shows the “Available Tx Modulation Type” and “Available Tx Code Rate” choices.

With VersaFEC ACM (IP-ACM) or VersaFEC-2 ACM (V2-ACM) modes selected:

```
Modulation:
Controlled by ACM
```

When VersaFEC ACM (IP-ACM) or VersaFEC-2 ACM (V2-ACM) mode is selected, the Modulation Type is controlled by ACM.

### 6.3.2.3.3 (CONFIG: Tx) Code (Code Rate)

```
Tx Code Rate: .488
```

Use the ◀ ▶ arrow keys to select the Tx Code Rate. Press **ENTER**. Refer to the table in **Section 6.3.2.3.1**, the “Tx FEC Encoder Selection” which shows the “Available Tx Modulation Type” and “Available Tx Code Rate” choices.

With VersaFEC ACM (IP-ACM) or VersaFEC-2 ACM (V2-ACM) modes selected:

```
Tx Code Rate:
Controlled by ACM
```

When VersaFEC ACM (IP-ACM) or VersaFEC-2 ACM (V2-ACM) mode is selected, the Tx Code Rate is controlled by ACM.

### 6.3.2.3.4 (CONFIG: Tx) Data (Data Rate)



The VersaFEC ACM (IP-ACM) or VersaFEC-2 ACM (V2-ACM) modes change the (CONFIG: Tx) Data (Data Rate) to (CONFIG:Tx) Symb (Symbol Rate) when active. Refer to Section 6.3.2.3.5 for details.

```
TxDataRate:00031.139kbps
0063.866ksps (◀ ▶,▲ ▼,ENT)
```



The Tx Data Rates associated with selection of the VFEC (VersaFEC), ULL (Ultra Low Latency), Tx FEC types are UNAVAILABLE when operating in CDM-570 Compatible Mode. See Section 6.2 for further information.

The overall range of data rates is from 2.4 to 10239 kbps. The overall range of symbol rates is from 37 to 3000 ksps. The minimum and maximum data rates are dependent on modulation type and FEC encoder rate. If you change the modulation or FEC type and the currently selected data rate is no longer supported, the modem then automatically adjusts the data rate up or down, keeping the symbol rate constant. The bottom line of the display shows the symbol rate, based on FEC type, Modulation type, FEC Code Rate, and Data Rate. The table that follows lists the valid range of data rates.

If G.703 is the current interface type, the data rate is automatically set to either 1544 kbps (T1) or 2048 kbps (E1).

**IMPORTANT NOTE –** Where noted in the following table, if EDMAC framing is employed, the upper data rate is reduced by 5% for data rates up to 2.048 Mbps, and by 1.6% for data rates above 2.048 Mbps, where EDMAC2 framing is used, or for Rate 21/44 BPSK/QPSK TPC, or Rate 5/16 BPSK TPC.

FEC Type	Modulation	Code Rate	Data Rate Range		EDMAC limited?
			Lower Limit (kbps)	Upper Limit (Mbps)	
Viterbi	BPSK	1/2	2.4	1.500	Yes – see preceding "IMPORTANT" Note 4
	QPSK/OQPSK	1/2	4.8	3.000	
		3/4	7.2	4.500	
		7/8	8.4	5.250	
Viterbi + R-S	BPSK	1/2	2.4	1.363	
	QPSK/OQPSK	1/2	4.3	2.727	
		3/4	6.5	4.091	
		7/8	7.5	4.666	
	16-QAM	3/4	13.0	4.000	
		7/8	16.8	4.666	

FEC Type	Modulation	Code Rate	Data Rate Range		EDMAC limited?
			Lower Limit (kbps)	Upper Limit (Mbps)	
TCM + R-S	8-PSK	2/3	8.7	4.400	Yes – see preceding "IMPORTANT" Note 4
Turbo	BPSK	5/16	2.4	0.937	
		21/44	2.4	1.430	
	QPSK/OQPSK	21/44	4.8	2.860	
		3/4	7.2	4.500	
		7/8	8.4	5.250	
	8-PSK/8-QAM	0.95	9.1	5.666	
		3/4	10.8	6.750	
		7/8	13.6	7.875	
0.95		15.3	8.500		
16-QAM	3/4	14.4	9.000		
	7/8	16.8	9.980		
VersaFEC	BPSK	0.488	2.4	1.462	No
	QPSK	0.533	5.2	3.200	
		0.631	6.1	3.785	
		0.706	6.8	4.233	
		0.803	7.8	4.818	
	8-QAM	0.576	8.3	5.179	
		0.642	9.3	5.782	
		0.711	10.3	6.401	
		0.780	11.3	7.021	
	16-QAM	0.644	12.4	7.726	
		0.731	14.1	8.776	
		0.780	15.0	9.361	
		0.829	16.0	9.946	
0.853		16.4	10.239		
Ultra-Low Latency (ULL)	BPSK	0.493	2.4	1.480	No
	QPSK	0.493	4.7	2.960	
		0.654	6.3	3.924	
		0.734	7.0	4.405	

FEC Type	Modulation	Code Rate	Data Rate Range		EDMAC limited?
			Lower Limit (kbps)	Upper Limit (Mbps)	
VersaFEC-2 Long Block	BPSK	0.489	18.1	1.469	No
	QPSK	0.489	36.2	2.938	
		0.537	39.8	3.225	
		0.586	43.4	3.518	
		0.611	45.2	3.664	
		0.635	47.0	3.811	
		0.660	48.8	3.958	
		0.684	50.6	4.104	
		0.733	54.2	4.397	
	8-ARY	0.521	93.8	4.691	
		0.537	96.7	4.837	
		0.562	101.1	5.057	
		0.585	105.5	5.277	
		0.611	109.9	5.497	
		0.635	114.3	5.717	
		0.660	118.7	5.936	
		0.684	123.1	6.156	
	16-ARY	0.708	127.5	6.376	
		0.733	131.9	6.596	
		0.586	234.5	7.036	
		0.611	244.3	7.329	
		0.635	254.1	7.622	
		0.660	263.8	7.915	
		0.684	273.6	8.208	
		0.708	283.4	8.502	
	32-ARY	0.733	293.2	8.795	
		0.757	302.9	9.088	
		0.782	312.7	9.381	
		0.660	824.5	9.894	
		0.684	855.0	10.239	
		0.708	885.6	10.239	
		0.733	916.1	10.239	
		0.757	946.7	10.239	
		0.782	977.2	10.239	
		0.801	1001.6	10.239	
	0.831	1038.3	10.239		
	0.855	1068.8	10.239		
	0.879	1099.3	10.239		



FEC Type	Modulation	Code Rate	Data Rate Range		EDMAC limited?
			Lower Limit (kbps)	Upper Limit (Mbps)	
VersaFEC-2 Short Block	BPSK	0.489	18.1	0.490	No
	QPSK	0.489	36.2	0.979	
		0.537	39.8	1.075	
		0.586	43.4	1.173	
		0.611	45.2	1.221	
		0.635	47.0	1.270	
		0.660	48.8	1.319	
		0.684	50.6	1.368	
		0.733	54.2	1.466	
	8-ARY	0.521	93.8	1.564	
		0.537	96.7	1.612	
		0.562	101.1	1.686	
		0.585	105.5	1.759	
		0.611	109.9	1.832	
		0.635	114.3	1.906	
		0.660	118.7	1.979	
		0.684	123.1	2.000	
	16-ARY	0.708	127.5	2.000	
		0.733	131.9	2.000	
		0.586	234.5	2.000	
		0.611	244.3	2.000	
		0.635	254.1	2.000	
		0.660	263.8	2.000	
		0.684	273.6	2.000	
		0.708	283.4	2.000	
	32-ARY	0.733	293.2	2.000	
		0.757	302.9	2.000	
		0.782	312.7	2.000	
		0.660	824.5	2.000	
		0.684	855.1	2.000	
		0.708	885.6	2.000	
		0.733	916.1	2.000	
0.757		946.7	2.000		
None (Uncoded)	BPSK	Uncoded	4.8	3.000	Yes – see preceding "IMPORTANT" Note 4
	QPSK/OQPSK	Uncoded	9.6	5.000	

### 6.3.2.3.5 (CONFIG: Tx) Symb (IP-ACM or V2-ACM Modes Only)



Verify that (CONFIG: TI) IP-ACM or (CONFIG: TI) V2-ACM is selected to continue with this section.

The IP-ACM (VersaFEC ACM) mode requires the appropriate FAST codes for the maximum operating symbol rate.



Appendix P. ADAPTIVE CODING and MODULATION (ACM) OPTION

```
TxSymRate: 00031.139ksps
00031.139kbps (< >,▲ ▼,ENT)
```

It is important that you understand that the use of VersaFEC ACM (**IP-ACM**) or VersaFEC-2 ACM (**V2-ACM**) modes represent fundamental departures from the way you would typically configure the modem. When either ACM mode is active, the **CONFIG: Tx** menu changes the **Data** option to **Symb**.

**On the top line** – Edit the **Tx Symbol Rate** by using the < > arrow keys to select the digit to edit. Then, use the ▲ ▼ arrow keys to change that digit. Press **ENTER**.

### 6.3.2.3.6 (CONFIG: Tx) Frq (Frequency)

```
Tx IF Freq:1156.3456 MHz
(< >,▲ ▼,ENT)
```

To edit, use the < > arrow keys to select a digit, and then use the ▲ ▼ arrow keys to change that digit. Press **ENTER**.

**For the CDM/R-570AL only:** The valid range of frequencies is from **950** to **2250** MHz, in steps of 100 Hz.



**If the Tx IF Frequency is set above 2000 MHz, and you then set the modem to CDM-570 Compatible Mode, the Tx IF Frequency will be reset to 1201 MHz. Be sure to reconfigure your Tx IF Frequency as needed.**

Note that, if using the **CONFIG: ODU→BUC** menus and you select a **BUC LO** frequency other than zero, and you define whether the mix is high-side or low-side, then the display changes to include the calculated Transmit RF frequency of the modem/BUC combination. Also, note that as you edit the **Tx IF** frequency, the RF frequency updates automatically:

```
Tx IF Freq:1156.3456 MHz
RF=14156.3456 (< >,▲ ▼,ENT)
```

**For the CDM-570A only:** The allowable range of frequencies is from **50 to 90 MHz** and from **100 to 180 MHz**, in steps of 100 Hz, as this example shows (note that the modem displays leading zeros to maintain compatibility with the L-Band firmware):

```
Tx IF Freq:0085.1234 MHz
      (< >,▲ ▼,ENT)
```

### 6.3.2.3.7 (CONFIG: Tx) On/Off

```
Tx Output State: Off On
Rx-Tx Inhibit(< >,ENTER)
```

Use the < > arrow keys to select **Off**, **On**, or **Rx-Tx Inhibit**. Press **ENTER**.

#### (CONFIG:Tx) Off/On → Rx-Tx Inhibit

```
RTI-Timeout Value: 10s
7s 4s 2s 1s (< >,ENTER)
```

Use the < > arrow keys to select the RTI Timeout value (in seconds) as **10s**, **7s**, **4s**, **2s**, or **1s**. Press **ENTER**.



**CAUTION – USE THE Rx-Tx INHIBIT FEATURE WITH EXTREME CARE!**

**RTI means RECEIVE/TRANSMIT INHIBIT. When you select this feature, the modem prevents transmission of the Tx carrier until the demodulator is locked. To prevent the Tx Carrier from turning off when the demodulator loses lock for a very short period of time, you must instruct the demodulator to unlock continuously for a selected time period (10, 7, 4, 2, or 1 seconds) before the mode inhibits the transmit carrier.**

**Enabling the RTI feature does not affect the internal IF loopback feature. Be aware, however, that if you attempt an external IF loopback (by connecting an external cable from the Tx IF output to the Rx IF input), then this will not work! The Tx carrier cannot turn on until the demod locks, and the demod cannot lock because the Tx output is off. The net result is that the demod will not lock and the Tx carrier will not turn on.**

### 6.3.2.3.8 (CONFIG: Tx) Pwr (Power)

```
Output Power Level Mode:
Manual  AUPC  CnC-APC
```

Use the < > arrow keys to set the output power level mode. Press **ENTER**.

#### (CONFIG: Tx) Output Power Level Mode: Manual

```
Tx Output Power Level:
-03.9 dBm (< >,▲ ▼ ENT)
```

To edit the Tx Output Power Level, use the ◀ ▶ arrow keys to select a digit, and then use the ▲ ▼ arrow keys to change that digit. Press **ENTER**. Note the following:

- For the **CDM-570AL**, the valid range of output power is from **0 dBm** to **-40 dBm**.
- For the **CDM-570A**, the valid range of output power is from **0 dBm** to **-25 dBm**.

## (CONFIG: Tx) Output Power Level Mode: AUPC



### Appendix E. AUPC (AUTOMATIC UPLINK POWER CONTROL)

- If you do not select 'Framed' or 'IP-ACM' mode, and you then attempt to select **AUPC**, the modem displays the following message:

**Warning! AUPC needs Framed Mode or ACM Mode**

This indicates **Manual mode is active**. Press **ENTER** or **CLEAR** to return to the previous menu.

- If you select **IP**, **IP-ACM** or **V2-ACM**, and then select **(Config: Tx) Pwr AUPC**, the modem displays the AUPC submenu as follows:

```
Max-Range Tx-Alarm
DemodUnlock      (◀ ▶)
```

Use the ◀ ▶ arrow keys to select a parameter. Press **ENTER**.

## (CONFIG: Tx) Output Power Level Mode: AUPC → Max-Range

```
Maximum-permitted Power
increase: 3.0dB(▲▼,ENT)
```

Use the ▲ ▼ arrow keys to change the value of maximum permitted increase in power level (when in **AUPC** mode). Press **ENTER**. The default value is 1 dB, and the upper limit is 9 dB.

## (CONFIG: Tx) Output Power Level Mode: AUPC → Tx-Alarm

```
Tx Alarm: None MaxPower
MinModcod      ◀ ▶
```

To set the action that occurs if the AUPC causes the maximum output power level to be reached, use the ◀ ▶ arrow keys to select **None**, **MaxPower**, or **MinModcod**. Press **ENTER**.

## (CONFIG: Tx) Output Power Level Mode: AUPC → DemodUnlock

```
Action when Remote Demod
unlocks: Nom Max Hold ◀ ▶
```

To set the action that occurs if the remote demod is unlocked, use the ◀ ▶ arrow keys to select **Nom**, **Max**, or **Hold**. Press **ENTER**.

Parameter	Description
<b>Nom</b>	(Nominal Power) The output level reverts to the nominal power level set under Manual.
<b>Max</b>	(Maximum Power) The output level changes to the maximum permitted.
<b>Hold</b>	Only available in ACM mode. Power level remains the same when unlock occurs.

### (CONFIG: Tx) Output Power Level Mode: CnC-APC



See Section G.6.7 CnC-APC Setup in Appendix G. DOUBLE TALK CARRIER-IN-CARRIER OPTION.

#### 6.3.2.3.9 (CONFIG: Tx) Scr (Scrambling)



**IMPORTANT NOTE – All selections are always viewable. If a Hardware or FAST option is either uninstalled or invalid, the cursor will skip past the unavailable choice.**

```
Tx Scrambling:Default-On
IESS-315-On Off (◀ ▶, ENT)
```

Use the ◀ ▶ arrow keys to select a parameter. Press **ENTER**.

Parameter	Description
<b>Default-On</b>	<p>The appropriate scrambler type is automatically selected.</p>  <p>The default scrambler types are:</p> <ul style="list-style-type: none"> <li>• Uncoded – ITU V.35 (Intelsat variant)</li> <li>• Viterbi, no framing – ITU V.35 (Intelsat variant)</li> <li>• Viterbi, EDMAC frame – Comtech proprietary, frame synchronized</li> <li>• Viterbi +RS or TCM/RS – Per IESS-308, frame synchronized</li> <li>• TPC – Comtech proprietary, frame synchronized</li> <li>• 8-QAM TPC – ITU V.35 (Intelsat variant)</li> <li>• VF or ULL – ITU V.35 (Intelsat variant)</li> <li>• VF2S or VF2L – ITU V.35 (Intelsat variant)</li> </ul>
<b>Off</b>	No scrambling

**NOTE:** In legacy CDM-570 Compatible mode, IESS-315 is not available for all FEC types. However, in CDM-570A mode, IESS-315 is a permitted choice for all FEC types. When IESS-315 is selected, the ITU V.35 scrambler specified in IESS-315 takes priority over all “Default-On” scramblers and is used instead. Therefore, for many operating modes, the two scrambler selections are redundant.

When using Carrier-in-Carrier, the IESS-315 (V.35) scrambler is the only permitted choice.

### 6.3.2.3.10 (CONFIG: Tx) Clk (Clock Source)

```
Tx Clocking Mode:  Int
Ext Loop-Timed (< >,ENTER)
```

Use the < > arrow keys to select **Int**, **Ext**, or **Loop-Timed**. Press **ENTER**.

Parameter	Description
<b>Int</b>	(Internal) Indicates that the modem will supply a clock to the DTE, which is derived from its internal frequency reference.
<b>Ext</b>	(External) Indicates that the modem expects to receive a clock from the DTE, to which the modem can phase-lock its internal circuits. (If G.703 is selected as the Interface type, the firmware will force the clock mode to External.)
<b>Loop-Timed</b>	Indicates that the transmit timing source should be the receive clock, from the direction of the satellite. This is a useful mode, in that no external connection needs to be made in this mode. If the demodulator loses lock, or if there is no receive signal present, the internal clock is substituted. Note also that this mode will work even with asymmetric Rx and Tx data rates.

### 6.3.2.3.11 (CONFIG: Tx) Inv (Inversion Functions)

```
Tx Inversion functions:
Spectrum Data Clock
```

Use the < > arrow keys to select **Spectrum**, **Data**, or **Clock**. Press **ENTER**. Typical for each screen, use the < > arrow keys to select **Normal** or **Inverted**. Press **ENTER**.

#### (CONFIG: Tx) Tx Inversion functions: Spectrum

```
Tx Spectrum:  Normal
Inverted      (< >,ENTER)
```

#### (CONFIG: Tx) Tx Inversion functions: Data

```
Tx Data Sense:  Normal
Inverted        (< >,ENTER)
```

#### (CONFIG: Tx) Tx Inversion functions: Clock



This feature is **UNAVAILABLE** when operating in **CDM-570 Compatible Mode**. See Section 6.2 for further information.

```
Tx Clock Invert:  Normal
Inverted          (< >,ENTER)
```

### 6.3.2.3.12 (Config: Tx) $\alpha$ (Tx Alpha Filter Rolloff Factor)

```
Tx $\alpha$ : .35 .25 .20 .15 .10
      .05      (◀ ▶, ENT)
```

Use the ◀ ▶ arrow keys to select a Tx Alpha Filter Rolloff Factor (Tx $\alpha$ ) of **.35**, **.25**, **.20**, **.15**, **.10**, or **.05**. Press **ENTER**.



- **.35 is the default Tx Alpha Filter Rolloff Factor (Tx $\alpha$ ).**
- **Set the Rx Alpha Filter Rolloff Factor (Rx $\alpha$ ) to .35 when the Tx $\alpha$  of the received signal is .25 or .35.**
- **Set the Rx $\alpha$  to .12 when the Tx $\alpha$  of the received signal is .05, .10, .15, or .20.**
- **When operating in CDM-570 Compatible Mode, the Tx $\alpha$  is fixed to the default value of .35. Selection of this feature and its options becomes disabled and unavailable. See Section 6.2 for further information.**

### 6.3.2.4 CONFIG: Rx (Receive)

```
Rx:FEC Dem Code Data Frq
Acq Descr Buf Inv EbNo  $\alpha$ 
```

Use the ◀ ▶ arrow keys to select an Rx parameter. Press **ENTER**.

Parameter	Sect.	Description
<b>FEC</b>	<b>6.3.2.4.1</b>	(FEC) Select the method of FEC used for reception (Viterbi, TPC, etc.). FEC type takes the highest configuration priority.
<b>Dem</b>	<b>6.3.2.4.2</b>	(Demodulation) Select the demodulation type used for reception (BPSK, QPSK, 8-PSK, etc.). The choice of demodulation will depend on the FEC type chosen.
<b>Code</b>	<b>6.3.2.4.3</b>	(FEC Code Rate) Select the FEC Code Rate used for reception (Rate 1/2, Rate 3/4, etc.). The choice of Code Rate will depend on both the FEC type and Demodulation selected.
<b>Data</b>	<b>6.3.2.4.4</b>	(Data Rate) Select the receive data rate, in steps of 1 bps. The choice of data rate will depend on the FEC type, Demodulation, and Code Rate selected. <b>NOTE:</b> This parameter is not available when VersaFEC ACM (IP-ACM) or VersaFEC-2 ACM (V2-ACM) is selected.
<b>Symb</b>	<b>6.3.2.4.5</b>	(Symbol Rate) Used with VersaFEC ACM (IP-ACM) or VersaFEC-2 ACM (V2-ACM) modes only. When either ACM mode is active, the CONFIG:Rx menu changes the Data option to Symb.
<b>Frq</b>	<b>6.3.2.4.6</b>	(Frequency) Select the transmit frequency, in steps of 100Hz. <ul style="list-style-type: none"> <li>• CDM/R-570AL(L-Band) range: 950 MHz to 2250 MHz</li> <li>• CDM-570A (70/140 MHz) range: 50 to 90 MHz and 100 to 180 MHz</li> </ul>
<b>Acq</b>	<b>6.3.2.4.7</b>	(Acquisition) Set the amount of frequency uncertainty the demodulator will search over in order to find and lock to an incoming carrier.
<b>Descr</b>	<b>6.3.2.4.8</b>	(Descrambler) Select whether or not data descrambling is used.

Parameter	Sect.	Description
Buf	6.3.2.4.9	(Buffer) Select whether or not the Plesiochronous/Doppler buffer is used, and if so, the size of that buffer.
Inv	6.3.2.4.1 0	(Inversion) Invert the sense of the received spectrum or the received baseband data.
EbNo	6.3.2.4.1 1	(Eb/No Alarm threshold) Set the Eb/No alarm threshold. NOTE: This parameter is not available when VersaFEC ACM (IP-ACM) or VersaFEC-2 ACM (V2-ACM) is selected.
SNR	6.3.2.4.1 2	(SNR) Used with VersaFEC ACM (IP-ACM) or VersaFEC-2 ACM (V2-ACM) modes only. When either ACM mode is active, the CONFIG:Rx menu changes the EbNo option to SNR.
$\alpha$	6.3.2.4.1 3	Rx Alpha Filter Rolloff Factor dictates how fast the spectral edges of the carrier attenuate beyond the 3 dB bandwidth.



**VERY IMPORTANT NOTE – The FEC type takes the highest configuration priority, and the selection here depends on what, if any, optional plug-in codecs are installed. The choice of FEC type then determines what demodulation types, code rates, and data rates are available. The order of hierarchy is therefore:**

**FEC type (Highest) ► Demodulation type ► Code Rate ► Data Rate (Lowest)**  
When you change a parameter within this hierarchy, the other parameters may become invalid. In this case, the firmware will change those other parameters to ensure that the configuration remains valid at all times.

**Example: Suppose you have selected Viterbi + Reed-Solomon, QPSK, Rate 1/2. Then, you change the demodulation type from QPSK to 16-QAM. In this case, Rate 1/2 is no longer a valid code rate, so it is automatically changed to the nearest valid code rate (Rate 3/4).**

### 6.3.2.4.1 (CONFIG: Rx) FEC (FEC Decoder Type)

```
RxFEC: Vit Vit-RS TCM-RS
TPC VF ULL VF2L VF2S Unc
```

With VersaFEC ACM (IP-ACM) mode active:

```
Rx FEC: Fixed VFEC (ACM)
```

With VersaFEC-2 ACM (V2-ACM) mode active, only VF2L or VF2S can be selected:

```
RxFEC: Vit Vit-RS TCM-RS
TPC VF ULL VF2L VF2S Unc
```

Use the ◀ ▶ arrow keys to select the FEC Decoder type. Press **ENTER**.





**IMPORTANT NOTE – All selections are always viewable. If a Hardware or FAST option is either uninstalled or invalid, the cursor will skip past the unavailable choice.**

**The VFEC (VersaFEC), ULL (Ultra Low Latency), VF2L (VersaFEC-2 Long Block), and VF2S (VersaFEC-2 Short Block) Rx FEC types and their available Rx Demodulation Types, Codes, and Data Rates are UNAVAILABLE when operating in CDM-570 Compatible Mode. If the Rx FEC Type is VFEC or ULL when CDM-570 Compatible Mode is selected, then the Rx FEC Type will be reset to Viterbi and the Demodulation and Code Rate will also be reset to appropriate values. See Section 6.2 for further information.**

Rx FEC Decoder Selection	Available Rx Demodulation Type	Available Rx Code Rate
Viterbi	BPSK	Fixed at 1/2
	QPSK	1/2, 3/4, 7/8
	OQPSK	
Vit-RS (Viterbi + Concatenated Reed-Solomon)	BPSK	Fixed at 1/2
	QPSK	1/2, 3/4, 7/8
	OQPSK	
	16-QAM (FAST)	3/4, 7/8
TCM-RS (Trellis Coded Modulation + Concatenated Reed-Solomon)	8-PSK (FAST)	Fixed at 2/3
TPC (Turbo Product Codec)	BPSK	5/16, 21/44
	QPSK	21/44, 3/4, 7/8, 0.95
	OQPSK	
	8-PSK (FAST)	3/4, 7/8, 0.95
	8-QAM (FAST)	
	16-QAM (FAST)	3/4, 7/8
VFEC (VersaFEC)	BPSK	Fixed at .488
	QPSK	.533, .631, .706, .803
	8-QAM (FAST)	.576, .642, .711, .780
	16-QAM (FAST)	.644, .731, .780, .829, .853
VF2L (VersaFEC-2 Long Block)	BPSK	0.489
	QPSK	0.489, 0.537, 0.586, 0.611, 0.635, 0.660, 0.684, 0.733
	8-ARY	0.521, 0.537, 0.562, 0.586, 0.611, 0.635, 0.660, 0.684, 0.708, 0.733
	16-ARY	0.586, 0.611, 0.635, 0.660, 0.684, 0.708, 0.733, 0.757, 0.782
	32-ARY	0.660, 0.684, 0.708, 0.733, 0.757, 0.782, 0.801, 0.831, 0.855, 0.879

Rx FEC Decoder Selection	Available Rx Demodulation Type	Available Rx Code Rate
VF2S (VersaFEC-2 Short Block)	BPSK	0.489
	QPSK	0.489, 0.537, 0.586, 0.611, 0.635, 0.660, 0.684, 0.733
	8-ARY	0.521, 0.537, 0.562, 0.586, 0.611, 0.635, 0.660, 0.684, 0.708, 0.733
	16-ARY	0.586, 0.611, 0.635, 0.660, 0.684, 0.708, 0.733, 0.757, 0.782
	32-ARY	0.660, 0.684, 0.708, 0.733, 0.757, 0.782, 0.801, 0.831
ULL (Ultra Low Latency)	BPSK	Fixed at .493
	QPSK	.493, .654, .734
Unc (Uncoded)	BPSK	Fixed at 1:1
	QPSK	
	OQPSK	

Refer to the preceding table, the “Rx FEC Decoder Selection” which shows the “Available Rx Demodulation Type” and “Available Rx Code Rate” choices.

#### 6.3.2.4.2 (CONFIG: Rx) Dem (Demodulation Type)

With VersaFEC (IP) mode selected:

**Demod: BPSK QPSK OQPSK  
8-PSK 16-QAM 8-QAM**

With VersaFEC-2 (VF2) mode selected:

**Demodulation: BPSK QPSK  
8-ARY 16-ARY 32-ARY**

Use the ◀ ▶ arrow keys to select the Rx Demodulation Type, and then press **ENTER**.

The “Rx FEC Decoder Selection” shows the “Available Rx Demodulation Type” and “Available Rx Code Rate” choices. See Section 6.3.2.4.1.

#### 6.3.2.4.3 (CONFIG: Rx) Code (Code Rate)

**Rx Code Rate: 5/16 21/44  
1/2 2/3 3/4 7/8 0.95 Unc**

Use the ◀ ▶ arrow keys to select the Rx Code Rate. Press **ENTER**. Refer to the table in **Section 6.3.2.4.1**, the “Rx FEC Decoder Selection” which shows the “Available Rx Demodulation Type” and “Available Rx Code Rate” choices.

#### 6.3.2.4.4 (CONFIG: Rx) Data (Data Rate)

```
Rx Dat Rate:5000.000kbps
2500.000ksym (◀ ▶,▲ ▼,ENT)
```



1. The Rx Data Rates associated with selection of the VFEC (VersaFEC), ULL (Ultra Low Latency), VF2L (VersaFEC-2 Long Block), and VF2S (VersaFEC-2 Short Block) FEC types are UNAVAILABLE when operating in CDM-570 Compatible Mode. See Section 6.2 for further information.
2. The overall range of data rates is from 2.4 to 10239 kbps. The overall range of symbol rates is from 4.8 to 3000 ksymbols/second. The minimum and maximum data rates are dependent on modulation type and FEC encoder rate. If you change the modulation or FEC type and the currently selected data rate is no longer supported, the modem then automatically adjusts the data rate up or down, keeping the symbol rate constant. The bottom line of the display shows symbol rate, based on FEC type, modulation, FEC Code Rate, and Data Rate.
3. If G.703 is the current interface type, the data rate is fixed either at 1544 kbps (T1) or 2048 kbps (E1).
4. \*IMPORTANT – Where noted in the following table: If EDMAC framing is employed, the upper data rate is reduced by 5% for data rates up to 2.048 Mbps, and by 1.6% for data rates above 2.048 Mbps, where EDMAC2 framing is used, or for Rate 21/44 BPSK/QPSK TPC, or Rate 5/16 BPSK TPC.

#### 6.3.2.4.5 (CONFIG: Rx) Symb (IP-ACM (VersaFEC ACM) or V2-ACM (VersaFEC-2 ACM) Modes Only)



Appendix P. ADAPTIVE CODING and MODULATION (ACM) OPTION



IP-ACM (VersaFEC ACM) modes require the appropriate FAST codes for the maximum operating symbol rate.

```
RxSymRate: 0065.066ksps
00031.204kbps (◀ ▶,▲ ▼,ENT)
```

When either ACM mode is active, the **CONFIG:Rx** menu changes the **Data** option to **Symb**.

**On the top line** – Edit the **Rx Symbol Rate** by using the ◀ ▶ arrow keys to select the digit to edit. Then, use the ▲ ▼ arrow keys to change that digit. Press **ENTER**. Note that asymmetric operation is supported – transmit and receive symbol rates do not have to be equal.

### 6.3.2.4.6 (CONFIG: Rx) Frq (Frequency)

```
Rx IF Freq:1156.3456 MHz
(◀ ▶,▲ ▼,ENT)
```

To edit the Receive IF Frequency, use the ◀ ▶ arrow keys to select a digit, and then use the ▲ ▼ arrow keys to change that digit. Press **ENTER**.

**For the CDM/R-570AL only:** The valid range of frequencies is from **950 to 2250 MHz**, in steps of 100 Hz.



**If the Rx IF Frequency is set above 2000 MHz, and you then set the modem to CDM-570 Compatible Mode, the Rx IF Frequency will be reset to 1201 MHz. Be sure to reconfigure your Tx IF Frequency as needed.**

Note that, if using the **CONFIG: ODU→LNB** menus and you select an **LNB** frequency other than zero and define whether the mix is high-side or low-side, the display changes to include the calculated Transmit RF frequency of the modem/LNB combination. Also, note that as you edit **Rx IF** frequency, the RF frequency updates automatically:

```
Rx IF Freq:1156.3456 MHz
RF=14156.3456 (◀ ▶,▲ ▼,ENT)
```

**For the CDM-570A only:** The range of frequencies permitted is from **50 to 90 MHz** and from **100 to 180 MHz**, in steps of 100 Hz, as this example shows (note that the modem displays leading zeros to maintain compatibility with the L-Band firmware):

```
Rx IF Freq:0075.9876 MHz
(◀ ▶,▲ ▼,ENT)
```

### 6.3.2.4.7 (CONFIG: Rx) Acq (Acquisition Range)

```
Demod Acquisition Range:
+/- 010 kHz (▲ ▼,ENTER)
```

The Demod Acquisition Range determines the amount of frequency uncertainty the demodulator will search over in order to find and lock to an incoming carrier.

To edit the search range value, use the ◀ ▶ arrow keys to select a digit, and then use the ▲ ▼ arrow keys to change that digit. Press **ENTER**.

**For the CDM-570AL,** the range varies according to the symbol rate:

- From ±1 kHz to ±32 kHz for rates less than or equal to 625 ksymbols/sec.
- From ±1 kHz to ±200 kHz for rates greater than 625 ksymbols/sec.

**For the CDM-570A,** the range is from ±1 kHz to ±32 kHz.



**CAUTION MUST BE EXERCISED at low data rates where the acquisition range is greater than the symbol rate of the desired carrier. In this situation, you could inadvertently acquire lock on an adjacent (and hence undesired) carrier if that carrier has identical characteristics (modulation, FEC, code rate, data rate, etc.) to the carrier of interest.**

### 6.3.2.4.8 (CONFIG: Rx) Descram (Descrambling)



**IMPORTANT NOTE – All selections are always viewable. If a Hardware or FAST option is either uninstalled or invalid, the cursor will skip past the unavailable choice.**

**Descrambling: Default-On**  
**IESS-315-On Off (◀ ▶, ENT)**

Use the ◀ ▶ arrow keys to select a parameter. Press **ENTER**.

Parameter	Description
<b>Default-On</b>	<p>The appropriate scrambler type is automatically selected.</p>  <p>The default scrambler types are:</p> <ul style="list-style-type: none"> <li>• <b>Uncoded</b> – ITU V.35 (Intelsat variant)</li> <li>• <b>Viterbi, no framing</b> – ITU V.35 (Intelsat variant)</li> <li>• <b>Viterbi, EDMAC frame</b> – Comtech proprietary, frame synchronized</li> <li>• <b>Viterbi +RS or TCM/RS</b> – Per IESS-308, frame synchronized</li> <li>• <b>TPC</b> – Comtech proprietary, frame synchronized</li> <li>• <b>8-QAM TPC</b> – ITU V.35 (Intelsat variant)</li> <li>• <b>VF or ULL</b> – ITU V.35 (Intelsat variant)</li> <li>• <b>VF2S or VF2L</b> – ITU V.35 (Intelsat variant)</li> </ul>
<b>Off</b>	No scrambling

**NOTE:** In legacy CDM-570 Compatible mode, IESS-315 is not available for all FEC types. However, in CDM-570A mode, IESS-315 is a permitted choice for all FEC types. When IESS-315 is selected, the ITU V.35 scrambler specified in IESS-315 takes priority over all “Default-On” scramblers and is used instead. Therefore, for many operating modes, the two scrambler selections are redundant.

When using Carrier-in-Carrier, the IESS-315 (V.35) scrambler is the only permitted choice.

### 6.3.2.4.9 (CONFIG: Rx) Buf (Buffer)

**Rx Buffer: +/-32768 Bits**  
**(13.1ms) (▲ ▼, ENTER)**

When you select a value other than **Disabled**, this enables the Plesiochronous/Doppler Buffer, set to its selected size as per the preceding example. The available size selections, in bits, are **(+/-)00128, 00256, 00512, 01024, 02048, 04096, 08192, 16384, or 32768**.

While it is only possible to select the size in bits, the corresponding total buffer size displays in ms (which varies in inverse proportion to the data rate).

Use the ▲ ▼ arrow keys to select the desired bit size. Press **ENTER**.

The buffer’s input is the signal from the satellite, with any clock offsets and jitter.

The buffer’s output is derived from the local TRANSMIT clock. In this way, the receive data is perfectly synchronous with this local clock.

The modem can operate with independent receive and transmit data rates. Even in this configuration, where Rx data rate < > Tx data rate, the buffer's output clock is phase locked to the transmit clock.

When you select **Disabled**, this disables the Plesiochronous/Doppler Buffer:

```
Rx Buffer: Disabled (Loop
Timing Mode) (▲ ▼, ENTER)
```

The modem then derives the receive clock from the satellite signal, and is therefore subject to clock offsets relative to the local transmit clock. This is due, in part, to the originating clock being slightly different from the local clock (a so-called **plesiochronous** offset), and to the motion of the satellite (a **Doppler** offset).

#### 6.3.2.4.10 (CONFIG: Rx) Inv (Inversion Functions)

```
Rx Inversion functions:
Spectrum Data Clock
```

Use the ◀ ▶ arrow keys to select **Spectrum**, **Data**, or **Clock**. Press **ENTER**. Typical for each screen, use the ◀ ▶ arrow keys to select **Normal** or **Inverted**. Press **ENTER**.

##### (CONFIG: Rx) Rx Inversion functions: Spectrum

```
Rx Spectrum: Normal
Inverted (◀ ▶, ENTER)
```

##### (CONFIG: Rx) Rx Inversion functions: Data

```
Rx Data Sense: Normal
Inverted (◀ ▶, ENTER)
```

##### (CONFIG: Rx) Rx Inversion functions: Clock



This feature is **UNAVAILABLE** when operating in CDM-570 Compatible Mode. See Section 6.2 for further information.

```
Rx Data Sense: Normal
Inverted (◀ ▶, ENTER)
```

#### 6.3.2.4.11 (CONFIG: Rx) Eb/No



The VersaFEC ACM (IP-ACM) or VersaFEC-2 ACM (V2-ACM) change the (CONFIG: Rx) Eb/No to (CONFIG:Rx) SNR when active. Refer to Section 6.3.2.4.12 for details.

```
Eb/No Alarm Point:
02.0 dB (◀ ▶, ▲ ▼, ENTER)
```

You may define an alarm point value where, if the  $E_b/N_0$  falls below this value, the modem generates a receive traffic fault.

The valid range of values is from **0.1** to **16.0** dB.

To edit the  $E_b/N_0$  Alarm Point, use the ◀ ▶ arrow keys to select a digit, and then use the ▲ ▼ arrow keys to change that digit. Press **ENTER**.

When either ACM mode is active, the **CONFIG:Rx** menu changes the  $E_b/N_0$  option to **SNR**.

#### 6.3.2.4.12 (CONFIG: Rx) SNR (IP-ACM (VersaFEC ACM) or V2-ACM (VersaFEC-2 ACM) Modes Only)

```
SNR Alarm Point:
02.0 dB      (◀ ▶,▲ ▼,ENT)
```

When either ACM mode is active, the **CONFIG:Rx** menu changes the  $E_b/N_0$  option to **SNR**.

Edit the SNR Alarm Point by using the ◀ ▶ arrow keys to select a digit, and then use the ▲ ▼ arrow keys to change that digit. The allowable range is from 00.1 to 16.0 dB. Press **ENTER**.

#### 6.3.2.4.13 (Config: Rx) α (Rx Alpha Filter Rolloff Factor)

```
Rxα: .35 .12
      (◀ ▶,ENT)
```

Use the ◀ ▶ arrow keys to select an Rx Alpha Filter Rolloff Factor ( $Rx\alpha$ ) of **.35** or **.12**. Press **ENTER**.



- **.35 is the default Rx Alpha Filter Rolloff Factor ( $Rx\alpha$ ).**
- **Set the  $Rx\alpha$  to .35 when the  $Tx\alpha$  of the received signal is 0.25 or 0.35.**
- **Set the  $Rx\alpha$  to .12 when the  $Tx\alpha$  of the received signal is .05, .10, .15, or .20.**
- **When operating in CDM-570 Compatible Mode, the  $Rx\alpha$  is fixed to the default value of .35. Selection of this feature and its options becomes disabled and unavailable. See Section 6.2 for further information.**

---

#### 6.3.2.5 CONFIG: CEx (G.703 Clock Extension)

```
G703 Clock Extend: None
TxLock RxEnable (◀ ▶,ENT)
```

Use the ◀ ▶ arrow keys to select **None**, **TxLock**, or **RxEnable**. Press **ENTER**. When you select **TxLock** or **RxEnable**, the modem displays the following submenu:

```
Clk Extend Interface: T1
E1Bal E1Unbal (◀ ▶,ENTER)
```

Use the ◀ ▶ arrow keys to select **T1**, **E1Bal**, or **E1Unbal** as the G.703 Clock Extension interface. Press **ENTER**.

### 6.3.2.6 CONFIG: Frame (Framing Mode)



#### Appendix J. EDMAC CHANNEL

```
Framing Mode: Unframed
EDMAC EDMAC-2 (< >, ENT)
```

Use the ◀ ▶ arrow keys to select a parameter. Press **ENTER**.

Parameter	Description
<b>Unframed</b>	No framing is selected, no overhead is added, and the modem is with other manufacturers' equipment when operating in a 'standard' configuration.
<b>EDMAC</b>	Comtech EF Data's proprietary framing is added. The framing permits the bi-directional passing of M&C and AUPC data between local and distant-end units.
<b>EDMAC-2</b>	

#### 6.3.2.6.1 (CONFIG: Framing Mode) EDMAC or EDMAC-2

**EDMAC** is backward compatible with the CDM-500, CDM-550/T, CDM-570/570L, and CDM-600/L modems. **EDMAC-2** is a reduced overhead version of EDMAC. While it is not completely backward compatible with the modems mentioned here, it is backward compatible in some modes (for example, in TPC BPSK modes and at rates above 2.048 Mbps).

When you select **EDMAC** or **EDMAC-2**, the modem displays the following submenu:

```
Framing mix: AUPC-Only
AUPC+EDMAC (< >, ENTER)
```



**When you enable EDMAC or EDMAC-2 framing, the modem automatically enables AUPC but the specific EDMAC feature (passing M&C data from a local to a distant-end unit) requires further configuration.**

Use the ◀ ▶ arrow keys to select **AUPC-Only** or **AUPC+EDMAC**. Press **ENTER**.

Parameter	Description
<b>AUPC-Only</b>	(Default) None of the EDMAC features are available, even though framing is still enabled.
<b>AUPC+EDMAC</b>	The system further prompts whether to select the modem as an EDMAC Master or an EDMAC Slave.

#### (CONFIG: Framing Mode) EDMAC or EDMAC-2: AUPC+EDMAC

```
EDMAC Mode:
Master Slave (< >, ENTER)
```



Use the ◀ ▶ arrow keys to select **Master** or **Slave**. Press **ENTER**.

Parameter	Description
<b>Master</b>	An EDMAC Master is a unit that is local to the M&C computer, and which passes messages, via the overhead, to a distant-end modem.
<b>Slave</b>	An EDMAC Slave is a unit that is not local to the M&C computer; it is located at the distant-end of a satellite link.

### (CONFIG: Framing Mode) EDMAC or EDMAC-2: AUPC+EDMAC → Master

Distant-end Base Address  
0240 (◀ ▶, ▲ ▼, ENTER)

The valid range of addresses is from **0010** to **9990**, in increments of 10 only.

To edit the address of the distant-end modem to which this unit will pass messages, use the ◀ ▶ arrow keys to select a digit, and then use the ▲ ▼ arrow keys to change that digit. Press **ENTER**.



**You may not edit the last digit of the address; this is implemented so that a single Master may pass messages for up to 10 devices at the distant end.**

### (CONFIG: Framing Mode) EDMAC or EDMAC-2: AUPC+EDMAC → Slave

Address of this Slave  
Unit: 0241 (◀ ▶, ▲ ▼, ENT)

The valid range of addresses is from **1** to **9999**, although 'base 10' values are automatically skipped.

To edit the address of this Slave unit, use the ◀ ▶ arrow keys to select a digit, and then use the ▲ ▼ arrow keys to change that digit. Press **ENTER**.



**The Slave EDMAC address always ends in '1'. Keep in mind that this is a unit that is intended for location at the distant-end of a link, and is therefore under the control of a Master at the other end. This is the equivalent of putting the modem into Remote Control mode; no local control is possible.**

### 6.3.2.7 CONFIG: TI (Data Traffic Interface)

```
Data Intf: RS422 IP V.35
RS232 G703 IP-ACM V2-ACM
```

Use the ◀ ▶ arrow keys to select a parameter. Press **ENTER**.

#### 6.3.2.7.1 (CONFIG: TI) RS422 or V.35 or RS232

```
RTS/CTS Operation: (▲ ▼)
RTS/CTS Loop, No Action
```

For **RS422**, **V.35**, or **RS232**, the modem displays this typical submenu. Use the ▲ ▼ arrow keys to select an option. Press **ENTER**.

Parameter	Description
<b>Ignore RTS, Assert CTS</b>	RTS is ignored and CTS is asserted unconditionally.
<b>Loop, RTS Controls Tx Out</b>	RTS and CTS are looped, so that CTS echoes the state of RTS, and RTS controls the ON/OFF state of the carrier (in other words, the modem will not bring up its TX carrier until RTS is asserted).
<b>RTS/CTS Loop, No Action</b>	RTS and CTS are looped, so that CTS echoes the state of RTS, but RTS does not control the ON/OFF state of the carrier.
<b>N/A - 1:N system in use</b>	If the 1:N switch on the rear panel is active, then RTS/CTS are not supported; the pins are assigned to redundancy functions.

#### 6.3.2.7.2 (CONFIG: TI) IP



**This selection is functional only when the optional Packet Processor is installed.**

Select **IP** to toggle the optional Packet Processor operation. Once you select IP, the modem returns you to the **SELECT: Config** menu branch.

#### 6.3.2.7.3 (CONFIG: TI) G.703



**G.703 is not available when in IP mode.**

```
G.703 Type: T1
E1-Bal E1-Unbal (◀ ▶, ENT)
```

Use the ◀ ▶ arrow keys to select **T1**, **E1-Bal**, or **E1-Unbal**. Press **ENTER**.

**(CONFIG: TI) G703 → T1**

```
T1 Configuration: Length  
Line-Code      (◀ ▶, ENTER)
```

Use the ◀ ▶ arrow keys to select **Length** or **Line Code**. Press **ENTER**.

**(CONFIG: TI) G.703: T1 → Length**

```
T1 Line Length:  
000-133 feet (▲ ▼, ENTER)
```

The valid length spans, in feet, are **0-133**, **133-266**, **266-399**, **399-533**, or **533-655**.

Use the ▲ ▼ arrow keys to select the desired span. Press **ENTER**.

**(CONFIG: TI) G.703: T1 → Line-Code**

```
T1 Line Code (B8ZS):  
On  Off (AMI) (◀ ▶, ENTER)
```

Use the ◀ ▶ arrow keys to select **On** or **Off**. Press **ENTER**.

**(CONFIG: TI) G.703 → E1-Bal or E1-Unbal**

```
E1 Line Code (HDB3):  
On  Off      (◀ ▶, ENTER)
```

When you select **E1-Bal** or **E1-Unbal**, the modem displays this typical submenu.

Use the ◀ ▶ arrow keys to set operation as **On** or **Off**. Press **ENTER**.

**6.3.2.7.4 IP-ACM (VersaFEC ACM)**

This selection is functional only when the optional Packet Processor is installed.

```
ACM:ModCod Unlock-Action  
Target-SNR-Margin
```

Use the ◀ ▶ arrow keys to select a parameter. Press **ENTER**.

**(CONFIG: TI) IP-ACM → ModCod**

```
Min ModCod:00 16QAM .488  
Max ModCod:11 16QAM .853
```

Use the ◀▶ arrow keys to select the Min(imum) (on the top line) or Max(imum) ModCod range setting (on the bottom line). Then, use the ▲▼ arrow keys to define the range of ModCods (**00-11**) over which the system will operate. Press **ENTER**.

ModCod **00** is BPSK Rate 0.488 (0.49 bps/Hz), while ModCod **11** is 16-QAM Rate 0.853 (3.41bps/Hz).



**If you wish to constrain the system to run at a fixed ModCod, set the Min and Max ModCod values to be equal.**

The value of Max ModCod may be limited by other FAST codes installed. For example, suppose the 4100 ksps FAST option is installed, and the symbol rate set to 4100 ksps, the theoretical maximum data rate would be 14 Mbps at ModCod 11. However, if CnC is being used, with a 10 Mbps FAST limit the ACM Max ModCod will be limited to ModCod 7, or 9.6 Mbps.

### (CONFIG: TI) IP-ACM → Unlock-Action

```
Distant-end loses lock:
Go to Min Tx Modcod(▲ ▼)
```

Use this submenu to establish the desired action when the remote demod loses lock. This is important, as the ACM system depends on the feedback of the SNR metric from the remote demod to determine the optimum ModCod. Use the ▲▼ arrow keys to select **Go to min Tx ModCod** (recommended) or **Maintain Tx ModCod**. Press **ENTER**.

### (CONFIG: TI) IP-ACM → Target-SNR-Margin

```
Target SNR Margin:
1.0 dB (0.0 - 4.5) (▲ ▼)
```

Use the ▲▼ arrow keys to select a margin value from **0.0** to **4.5** dB, in 0.5 dB increments. Press **ENTER**.



**The ACM system is designed to switch based on thresholds that correspond to a BER of  $5 \times 10^{-8}$  for each ModCod. However, in order to prevent oscillation around two ModCods at this exact value, 0.3 dB of hysteresis has been added.**

#### 6.3.2.7.5 V2-ACM (VersaFEC-2 ACM)



**This selection is functional only when the optional Packet Processor is installed.**

```
ACM:ModCod Unlock-Action
Target-SNR-Margin
```

Use the ◀▶ arrow keys to select a parameter. Press **ENTER**.

## (CONFIG: TI) V2-ACM → ModCod

```
Min ModCod:00 BPSK .489
Max ModCod:37 32ARY .879
```

Use the ◀▶ arrow keys to select the Min(imum) (on the top line) or Max(imum) ModCod range setting (on the bottom line). Then, use the ▲▼ arrow keys to define the range of ModCods (00-37) over which the system will operate. Press **ENTER**.

The minimum setting for VF2S (VersaFEC-2 Short Block) and VF2L (VersaFEC-2 Long Block) is fixed at ModCod 00 (BPSK Rate 0.489 (0.49 bps/Hz)).

- For VF2S, the maximum selectable ModCod 35 is 32-ARY Rate 0.831 (4.153 bps/Hz)
- For VF2L, the maximum selectable ModCod 37 is 32-ARY Rate 0.879 (4.397 bps/Hz)

Press **ENTER**.



If you wish to constrain the system to run at a fixed ModCod, set the Min and Max ModCod values to be equal.

The value of Max ModCod may be limited by other FAST codes installed.

## (CONFIG: TI) V2-ACM → Unlock-Action

This screen is *read-only*. Press **ENTER** or **CLEAR** to return to the previous menu.

```
Distant-end loses lock:
Go to Min Tx Modcod(▲ ▼)
```

## (CONFIG: TI) V2-ACM → Target-SNR-Margin

```
Target SNR Margin:
1.0 dB (0.0 - 4.5) (▲ ▼)
```

Use the ▲▼ arrow keys to select a margin value from 0.0 to 4.5 dB, in 0.5 dB increments. Press **ENTER**.



The ACM system is designed to switch based on thresholds that correspond to a BER of  $5 \times 10^{-8}$  for each ModCod. However, in order to prevent oscillation around two ModCods at this exact value, 0.3 dB of hysteresis has been added.

---

### 6.3.2.8 CONFIG: Ref (Reference)



1. **IMPORTANT NOTE – The modem can accept an externally supplied frequency reference via the rear panel BNC connector.** Rather than bypassing the internal reference and substituting the external signal, the modem instead uses the internal reference in a low-bandwidth (~ 2 Hz) phase-locked loop (PLL), so the modem actually phase locks to the reference external signal. There are distinct advantages to this scheme:
  - This scheme permits hitless switching between the operation of internal and external reference. There are no sudden discontinuities of frequency and phase in the transmitted carrier.
  - Due to the very low bandwidth of the PLL, this scheme permits the external reference to employ an inferior phase noise characteristic instead of the internal reference of the modem. The narrow loop essentially ‘cleans up’ the external signal. This is particularly important if you use the CDM/R-570AL to supply a 10MHz reference to a BUC or LNB.
2. If Internal+O/P is your active Frequency Reference setting, and you then set the modem to CDM-570 Compatible Mode, the modem will reset this feature to Internal 10 MHz. Reconfigure your setting as needed. See Sect. 6.2 for further information.

Use the ▲ ▼ arrow keys to select **Internal+O/P**, **Internal 10 MHz**, **External 01 MHz**, **External 02 MHz**, **External 05 MHz**, or **External 10 MHz**. Press ENTER.

Examples include:

```
Frequency Reference:  
Internal 10 MHz (▲ ▼,ENT)
```

```
Frequency Reference:  
Internal+O/P (▲ ▼,ENT)
```

### 6.3.2.9 CONFIG: Msk (Alarm Masking)

CDM/R-570AL(L-Band) unit:

```
Alarm Mask: Transmit
Receive Ref BUC LNB (< >)
```

CDM-570A (70/140 MHz) unit:

```
Alarm Mask: Transmit
Receive Ref (< >)
```

Use the ◀ ▶ arrow keys to select **Transmit**, **Receive**, **Ref**, **BUC** (CDM/R-570ALonly), or **LNB** (CDM/R-570ALonly). Press **ENTER**.

#### 6.3.2.9.1 (CONFIG: Alarm Mask) Transmit

```
Tx Alarm Mask: Tx-FIFO
G703BPV TxAIS G703LOS < >
```

Use the ◀ ▶ arrow keys to select a parameter. Press **ENTER**.

Each choice displays a submenu similar to the **TX-FIFO** submenu:

```
Tx-FIFO Alarm:
Active Masked (< >,ENT)
```

Typical for each Tx Alarm submenu, use the ◀ ▶ arrow keys to select **Active** or **Masked**. Press **ENTER**.

When you select **Masked**, the modem generates no alarm. When you select **Active**, the modem generates a fault. For example, for the preceding TX-FIFO Tx Alarm Mask, with the mask set to **Active** the modem generates a Transmit Traffic fault whenever the transmitter sees that the Transmit FIFO has slipped.

#### 6.3.2.9.2 (CONFIG: Alarm Mask) Receive

```
Rx Alarm Mask: AGC Eb/No
Rx-AIS Buffer (< >,ENT)
```

Use the ◀ ▶ arrow keys to select **AGC**, **E<sub>b</sub>/N<sub>0</sub>**, **Rx-AIS**, or **Buffer**. Press **ENTER**. Each choice displays a submenu similar to the **AGC** submenu:

```
AGC Alarm:
Active Masked (< >,ENT)
```

Typical for each Rx Alarm submenu, use the ◀ ▶ arrow keys to select **Active** or **Masked**. Press **ENTER**.

When you select **Masked**, the modem generates no alarm. When you select **Active**, the modem generates a fault. For example, for the preceding AGC Alarm Mask, with the mask set to **Active** the modem generates a Receive Traffic fault whenever the demodulator sees that the composite input level being applied causes compression in the IF stages, and consequently degrades the performance of the demodulator.

### 6.3.2.9.3 (CONFIG: Alarm Mask) Ref

```
Reference Alarm:  
Active Masked (◀ ▶,ENT)
```

Use the ◀ ▶ arrow keys to select **Active** or **Masked**. Press **ENTER**.

When you select **Active**, the modem generates a Transmit Traffic fault whenever it sees that:

- External Reference is selected, and
- There is no signal activity at the External Reference port.

When you select **Masked**, the modem generates no alarm.

### 6.3.2.9.4 (CONFIG: Alarm Mask) BUC (CDM/R-570AL L-Band Units ONLY)



See Chapter 10. CDM-570A/570AL ODU (TRANSCEIVER, BUC, LNB) M&C OPERATIONS for complete details about using this modem-specific menu branch.

```
BUC Alarm:  
Active Masked (◀ ▶,ENT)
```

Use the ◀ ▶ arrow keys to set the alarm as **Active** or **Masked** for the BUC, if connected.

### 6.3.2.9.5 (CONFIG: Alarm Mask) LNB (CDM/R-570AL L-Band Units ONLY)



See Chapter 10. CDM-570A/570AL ODU (TRANSCEIVER, BUC, LNB) M&C OPERATIONS for complete details about using this modem-specific menu branch.

```
LNB Alarm:  
Active Masked (◀ ▶,ENT)
```

Use the ◀ ▶ arrow keys to set the alarm as **Active** or **Masked** for the LNB, if connected.



### 6.3.2.10 CONFIG: CnC



1. CnC operation requires that you purchase one of several available FAST options to provide capability to a maximum of 10.239 Mbps.
2. This feature is UNAVAILABLE when operating in CDM-570 Compatible Mode. See Sect. 6.2 for further information.



- Appendix G. DoubleTalk Carrier-in-Carrier OPTION
- For more information about purchasing FAST options:
  - Sect. 6.2.8 SELECT: FAST menus
  - Sect. 1.3.10 Fully Accessible System Topology (FAST)
  - Chapter 5. FAST ACTIVATION PROCEDURE

```
CnC: Mode Freq-Offset
Search-Delay (< >, ENTER)
```

Use the ◀ ▶ arrow keys to select a parameter. Press ENTER.

#### 6.3.2.10.1 (CONFIG: CnC) Mode

CDM/R-570AL unit:

```
CnC Mode: Off On APC
Action (< >, ENTER)
```

CDM-570A unit:

```
Mode: Off
```

For either unit: the available CnC mode selections are:

- |               |                      |                      |
|---------------|----------------------|----------------------|
| • Off         | • APC,Side-A,C-Band  | • APC,Side-B,C-Band  |
| • On (normal) | • APC,Side-A,X-Band  | • APC,Side-B,X-Band  |
|               | • APC,Side-A,Ku-Band | • APC,Side-B,Ku-Band |
|               | • APC,Side-A,Ka-Band | • APC,Side-B,Ka-Band |

**For the CDM/R-570AL only:** Use the ◀ ▶ arrow keys to select CnC Mode as **Off** or **On**. (For CnC-APC controls, select **APC**.)

**For the CDM-570A only:** Use the ▲ ▼ arrow keys to select CnC Mode as **Off** or **On**. (Continued use of the ▲ ▼ arrow keys entails selection of CnC-APC controls.) Press ENTER.



See Sect. G.6 Carrier-in-Carrier Automatic Power Control (CnC-APC) in Appendix G. DoubleTalk Carrier-in-Carrier OPTION for complete details about, and setup of, the CnC-APC feature.

### 6.3.2.10.2 (CONFIG: CnC) Freq-Offset

```
CnC Freq-Offset Range:  
+/- 010 kHz (▲ ▼,ENTER)
```

Use this menu to **ENTER** the maximum expected frequency offset between the outbound interferer and the desired inbound. It normally corresponds to the demod acquisition range. Use the ▲ ▼ arrow keys to edit the CnC Frequency Offset value. Press **ENTER**.

This range is pre-calculated. The Rx symbol rate determines the CnC Frequency Offset:

- From 16 to 64 ksymbols/sec (ksps):  $\pm 1$  to the symbol rate (ksps/2)
- 64 ksps and above:  $\pm 1$  to 32kHz

**NOTE:** CnC operation with symmetrical links requires the Symbol Rate to be offset by 0.1% or higher on one of the links when the IP Data Interface is selected.

### 6.3.2.10.3 (CONFIG: CnC) Search-Delay

```
CnC Search Delay:  
Min: 240 ms Max: 300 ms
```

To reduce the time taken for the CnC algorithm to converge, you may apply restrictions to the range of delay used by the search. During initial link testing, you should set the delay to a minimum of 240 ms and a maximum of 300 ms. Once CnC has found the exact delay, the value can be further reduced but care should be taken to allow sufficient range to accommodate changes in path delay due to Doppler.



**If bench-testing CnC with two units in a back-to-back configuration, you should set the minimum delay to 0 ms, and the maximum delay to 20 ms. This takes into account the lack of satellite delay.**

To edit the **Min** or **Max** delay, use the ◀ ▶ arrow keys to select a digit, and then use the ▲ ▼ arrow keys to change that digit. Press **ENTER**.

---

### 6.3.2.11 CONFIG: ODU (CDM/R-570AL L-Band Units ONLY)



See Chapter 10. CDM-570A/570AL ODU (TRANSCEIVER, BUC, LNB) M&C OPERATIONS for complete details about using this modem-specific menu branch.

```
ODU (Outdoor Unit):  
BUC LNB (◀ ▶,ENTER)
```

Use the ◀ ▶ arrow keys to configure a BUC or LNB, if connected.

### 6.3.3 SELECT: Monitor

**MONITOR: Alarms Rx ACM  
Event Stats AUPC CnC ODU**

Use the ◀ ▶ arrow keys to select a parameter (ODU is available only with the CDM-570AL). Press **ENTER**.

#### 6.3.3.1 MONITOR: Alarms



**IMPORTANT NOTE – The CDM/R-570AL uses a system of Fault Prioritization, where the modem will display only the highest priority fault in a designated category. This cuts down significantly on unwanted and irrelevant fault reporting.**

For example, if the demodulator is unlocked, then it is irrelevant if there are other Rx faults present. However, if the demodulator then locks while a lower-priority fault is present, then the modem will display that fault. This also applies for faults reported via remote control.



For CDM/R-570AL units with ODUs, see Chapter 10. CDM-570A/570AL ODU (TRANSCIEVER, BUC, LNB) M&C OPERATIONS for details on selecting this submenu and the listing of prioritized ODU faults.

**Live Alarms:Unit Receive  
Transmit ODU (◀ ▶, ENTER)**

For 70/140 MHz or L-Band modems without ODUs, use the ◀ ▶ arrow keys to select **Unit**, **Receive**, or **Transmit**. Press **ENTER**.

LIST OF PRIORITIZED FAULTS		
Unit Faults	Tx Traffic Status	Rx Traffic Status
1) Power supply fault, +5 volts	1) No clock from terrestrial interface	1) Demodulator unlocked
2) Power supply fault, +12 volts	2) Tx PaP ETH Link Down	2) AGC Alarm - signal out of range
3) Power supply fault, -5 volts	3) Tx FIFO slip	3) APC Frame sync alarm
4) Power supply fault, -12 volts	4) Loss of Signal on G.703 interface	4) EDMAC Frame sync alarm
5) Tx synthesizer lock	5) Loss of External Reference	5) APC Band mismatch alarm
6) Rx 1 <sup>st</sup> LO synthesizer lock	6) AUPC upper limit reached	6) Buffer Underflow
7) Rx 2 <sup>nd</sup> LO synthesizer lock	7) AIS detected on incoming data (from terrestrial direction)	6) Buffer Overflow
8) Reference PLL lock	8) Bipolar violation on G.703 interface	7) E <sub>b</sub> /N <sub>0</sub> alarm
9) PaP Heartbeat	9) BUC Alarm (if attached)	8) LNB Alarm (if attached)
		9) AIS detected on incoming data (from satellite direction)

### 6.3.3.1.1 (MONITOR: Live Alarms) Unit

```
Unit Fault: -12 Volt PSU  
is Under-Voltage (ENT)
```

This screen displays Unit Faults. If none are present, it displays '**None**'. Press **ENTER** to return to the previous menu.

### 6.3.3.1.2 (MONITOR: Live Alarms) Receive (Receive Traffic Status)

```
Rx Traffic: AGC Alarm -  
Reduce Input level (ENT)
```

This screen displays Receive Traffic Faults. If none are present, it displays '**None**'. Press **ENTER** to return to the previous menu.

### 6.3.3.1.3 (MONITOR: Live Alarms) Transmit (Transmit Traffic Status)

```
Tx Traffic: No Tx Clock  
from Terrestrial (ENT)
```

This screen displays Transmit Traffic Faults. If none are present, it displays '**None**'. Press **ENTER** to return to the previous menu.

---

## 6.3.3.2 MONITOR: Rx

```
EbNo>16.0dB BER=0.0E-9  
ΔF=0.0k Buf=50 RSL=-42
```

With VersaFEC ACM (IP-ACM) or VersaFEC-2 ACM (V2-ACM) mode active:

```
SNR=22.0dB BER=0.0E-9  
ΔF=+0.0k Buf=50 RSL=-49
```

If the demodulator is **locked**, information displays as follows:

Parameter	Description
EbNo=	This shows the value of $E_b/N_0$ calculated by the demodulator. The value referred to here is the energy per information bit ( $E_b$ ), divided by the noise spectral density ( $N_0$ ).
SNR	This replaces “ $E_b/N_0$ ” when VersaFEC ACM (IP-ACM) or VersaFEC-2 ACM (V2-ACM) mode is active. In ACM, SNR is the preferred metric. Remember that: $SNR = Eb/No + 10_{\log}(\text{spectral efficiency})$ .
BER=	This shows an estimate of the corrected BER.
$\Delta F$ =	This shows the frequency offset of the received carrier, in kHz, in steps of 100 Hz.
Buf=	<b>(Buffer fill state)</b> This shows the fill state, in percent, of the receive Buffer. After a reset, it will read 50. A value below 50 indicates that the buffer is emptying, and above 50 indicates that it is filling.
RSL=	<b>(Receive Signal Level)</b> This shows the value, in dBm, of the desired carrier’s input power as seen by the demodulator. If the signal level is below the AGC range of the demod, this displays <b>RSL &lt;-99</b> .

Otherwise, if the demodulator is **not locked**, the message ‘**Demod: Not Locked**’ displays, but the screen continues to display the receive signal level, as this example shows:

```
Demod: Not Locked
RSL=-64
```

Press **ENTER** or **CLEAR** to return to the previous menu.

### 6.3.3.3 Monitor: ACM



**This screen is viewable only when the optional Packet Processor is installed.**

```
TMC00 BP.489 RmSNR=99.9
RMC00 BP.489 LcSNR=99.9
```

This **read-only** screen displays the active VersaFEC ACM (**IP-ACM**) or VersaFEC-2 ACM (**V2-ACM**) mode information, as follows:

Setting	Function
TxModCod	Displays the Tx ModCod: 00-11 (VersaFEC); 00-35 (VersaFEC 2 Short Block (VF2S)); 00-37 (VersaFEC-2 Long Block (VF2L)).
RemoteSNR	Displays the SNR reported by the remote modem.
RxModCod	Displays the Rx ModCod: 00-11 (VersaFEC); 00-35 (VersaFEC 2 Short Block (VF2S)); 00-37 (VersaFEC-2 Long Block (VF2L)).
LocalSNR	Displays the SNR of the local unit.

When you attempt to access this display when the modem is not in VersaFEC ACM (IP-ACM) or VersaFEC-2 ACM (V2-ACM) mode, the following message appears:

```
ACM Parameter is not avail
```

---

### 6.3.3.4 MONITOR: Event (Stored Events)

```
Stored Events:      View
Clear-All          (◀ ▶, ENTER)
```

Use the ◀ ▶ arrow keys to select **View** or **Clear-All**. Press **ENTER**.

#### 6.3.3.4.1 (MONITOR: Stored Events) View

```
Log23: 30/11/02 10:37:32
Fault - Demod Lock (▲ ▼)
```

When a fault condition occurs, the modem date- and time-stamps the fault, and enters it into the Stored Events Log. The modem also records when the fault condition clears, as this example shows:

```
Log240:30/11/97 10:37:35
Clear - Demod Lock (▲ ▼)
```

The Stored Events Log stores up to 255 events. Use the ▲ ▼ arrow keys to browse through the available entries. Press **ENTER** or **CLEAR** to return to the previous menu.

#### 6.3.3.4.2 (MONITOR: Stored Events) Clear-All

```
Clear all Stored Events?
No Yes          (▲ ▼, ENTER)
```

Use the ▲ ▼ arrow keys to select **No** or **Yes**. Press **ENTER**.

When you select **Yes**, the modem clears the event log and returns you to the previous menu. However, if a fault persists, the modem re-stamps the fault and generates a new log entry.



**In accordance with European convention, the date appears in DAY-MONTH-YEAR format.**

### 6.3.3.5 MONITOR: Stats (Link Statistics)



If you change your operating mode between IP-ACM Mode and any mode other than IP-ACM Mode, Comtech EF Data recommends that you first execute Clear-All from the MONITOR: Stats screen before you attempt to retrieve any further statistics.

```
Link Statistics:   View
Clear-All Config(◀ ▶,ENT)
```

Use the ◀ ▶ arrow keys to select **View**, **Clear-All**, or **Config**. Press **ENTER**.

#### 6.3.3.5.1 (MONITOR: Stats (Link Statistics)) View

```
Sta198:11/02/15 10:37:32
16.0, 16.0, 9.0, 9.0(▲ ▼)
```

The Link Statistics Log stores up to 255 events. Typical for all operating modes, the **top line** indicates the log entry number, and the time and date of the entry. Use the ▲ ▼ arrow keys to browse through the available entries. Press **ENTER** or **CLEAR** to return to the previous menu.



In accordance with European convention, the date appears in DAY-MONTH-YEAR format.

In any operating mode other than VersaFEC ACM (IP-ACM) / VersaFEC-2 ACM (V2-ACM) Mode:

The **bottom line** shows the measured and recorded statistics data: Minimum  $E_b/N_0$ ; Average  $E_b/N_0$ ; Maximum TPLI; and Average TPLI.



**TPLI = Transmit Power Level Increase – you must enable AUPC to review TPLI.**

The meaning and format of the numbers is as follows:

- Once you define a measurement interval (see **MONITOR: Stats → Config**), the modem observes  $E_b/N_0$  and TPLI at a once-per-second rate during this interval. At the end of the interval, the modem calculates and records the average  $E_b/N_0$  and the minimum value seen during the interval. Similarly, the modem calculates the TPLI along with the highest value seen during the interval.



If the demod loses lock during the measurement interval, the minimum  $E_b/N_0$  shows 'Loss' rather than indicates a value. However, the average value (while the demod was locked) will still be calculated and shown. If, on the other hand, you unlock the demodulator for the entire measurement interval, the average  $E_b/N_0$  will also show 'Loss'. (The display shows 'Loss, Loss'.)

- If the measured values are greater than or equal to 16.0 dB, the display shows '16.0'.

- When you do not enable AUPC, both maximum and average TPLI shows '0.0'.

**Examples: 08.0,13.5,2.5,1.8 means:**

Minimum  $E_b/N_0$  observed in the measurement interval = 8.0 dB  
Average  $E_b/N_0$  observed in the measurement interval = 13.5 dB  
Maximum TPLI observed in the measurement interval = 2.5 dB  
Average TPLI observed in the measurement interval = 1.8 dB

**Loss,04.5,0.0,0.0 means:**

There was a loss of demod lock during the measurement interval  
Average  $E_b/N_0$  observed in the measurement interval = 4.5 dB  
Maximum TPLI observed in the measurement interval = AUPC disabled  
Average TPLI observed in the measurement interval = AUPC disabled

The presentation of statistics information varies slightly when in VersaFEC ACM (IP-ACM) or VersaFEC-2 ACM (V2-ACM) mode.

**In VersaFEC ACM (IP-ACM) mode:**

```
Sta198:02/11/13 10:37:32  
16.0,16.0,2,4,0,0 (▲ ▼)
```

The **bottom line** calculates and then displays statistics data as follows:

**Example: 16.0,16.0,2,4,0,0 means:**

Minimum  $E_b/N_0$  observed in the measurement interval = 16.0 dB  
Average  $E_b/N_0$  observed in the measurement interval = 16.0 dB  
The Rx ModCod, in hex format, that was current when the entry was logged = 2  
Maximum Rx ModCod, in hex format, during the measurement interval = 4  
Minimum Rx ModCod, in hex format, during the measurement interval = 0  
Number of Rx ModCod changes, in hex format, during the measurement interval = 0



**In VersaFEC-2 ACM (V2-ACM) Mode:**

```
Sta198:02/11/13 10:37:32  
22.0, 22.0, 36, 00 (▲ ▼)
```

The modem calculates and then displays, on the top line from left to right, statistics data as follows:

- **(22.0, 22.0)** First, the SNR is calculated: The *minimum* SNR value observed in the measurement interval is provided first, and then the *average* SNR observed value follows. The screen displays 16.0 only if the measured values are  $\geq 16.0$  dB.
- **(37)** Maximum Rx ModCod, in decimal format, during the measurement interval.
- **(37)** Minimum Rx ModCod, in decimal format, during the measurement interval.

**6.3.3.5.2 (MONITOR: Stats (Link Statistics)) Clear-All**

```
Clear all Stored Stats?  
No Yes (▲ ▼, ENTER)
```

Use the ▲▼ arrow keys to choose **No** or **Yes**. Press **ENTER**. When you select **Yes**, the modem clears the Link Statistics Log and returns you to the previous menu.

**6.3.3.5.3 (MONITOR: Stats (Link Statistics)) Config (Configure)**

```
Stats Logging Interval:  
Disabled (▲ ▼, ENTER)
```

Valid logging interval settings (i.e., the time span, in minutes, over which the link statistics are measured) are **Disabled, 10, 20, 30, 40, 50, 60, 70, 80, or 90**.

To select a logging interval the ▲▼ arrow keys to select your desired interval setting. Press **ENTER**. Once set, the display reflects the selected interval:

```
Stats Logging Interval:  
30 minutes (▲ ▼, ENTER)
```

### 6.3.3.6 MONITOR: AUPC



#### Appendix E. AUPC (AUTOMATIC UPLINK POWER CONTROL)

When you select **AUPC** and the modem **is not** in 'Framed' or VersaFEC ACM (IP-ACM) mode, the modem displays the following message:

```
Warning! AUPC needs  
Frame Mode or IP-ACM
```

When you select **AUPC** and the modem is in 'Framed' mode, the screen appears as follows:

```
AUPC:Remote EbNo =Unlock  
TX Power Increase =0.00dB
```

- The **top line** displays the value of  $E_b/N_0$  of the demodulator at the distant end of the satellite link. The  $E_b/N_0$  displays **Unlock** if the remote demod is unlocked.
- The **bottom line** shows how much the AUPC system has increased the output power. If you do not enable AUPC, the value of **Tx Power Increase** shows as 0.0 dB.

**For VersaFEC ACM (IP-ACM) modes only:**

```
AUPC:Modem is in IP-ACM  
TX Power Increase =0.0dB
```

**For VersaFEC-2 ACM (V2-ACM) modes only:**

```
AUPC:Modem is in V2-ACM  
TX Power Increase =0.0dB
```

- The **top line** message directs you to consult the **Monitor: ACM** menu for the Remote and Local SNR values that are available in place of Remote  $E_b/N_0$  data.
- The **bottom line** shows how much the AUPC system has increased the output power. If you do not enable AUPC, the value of **Tx Power Increase** shows as 0.0 dB.

Press **ENTER** or **CLEAR** to return to the previous menu.

---

### 6.3.3.7 MONITOR: CnC



#### Appendix G. DOUBLETALK CARRIER-IN-CARRIER OPTION

When you select CnC and the demod is not locked, the modem displays the following message:

```
CnC:
  Demod Not Locked
```

When CnC is enabled and the demod is locked, the screen displays the CnC performance data. This *read-only* display updates once every second:

```
PR=+01.1dB  PSDR=+01.1dB
ΔF=-002.3kHz  Dly=249.6ms
```

---

### 6.3.3.8 MONITOR: ODU (CDM/R-570AL L-Band Units ONLY)



See Chapter 10. CDM-570A/570AL ODU (TRANSCEIVER, BUC, LNB) M&C OPERATIONS for complete details about this modem-specific menu branch.

```
Outdoor Unit Monitor:
BUC  LNB      (▲ ▼, ENTER)
```

**For the CDM/R-570AL only:** Use this menu branch to monitor a BUC or LNB, if connected. Use the ▲ ▼ arrow keys to select **BUC** or **LNB**. Press **ENTER** to continue or **CLEAR** to return to the previous menu.

### 6.3.4 SELECT: TEST

```
TEST: Mode BERT
```

Use the ◀ ▶ arrow keys to select **Mode** or **BERT**. Press **ENTER**.

### 6.3.4.1 TEST: Mode

```
TEST: Norm IF↓ Dig↓ I/O↓
RF↓ Tx-CW Tx-1,0 (◀ ▶,ENT)
```

Use this menu branch to execute a variety of test modes. Use the ◀ ▶ arrow keys to select a Test Mode. Press **ENTER**.

Mode	Description
<b>Norm</b>	<b>(Normal)</b> This clears any test modes or loopbacks, and places the modem back into an operational state.
<b>IF↓</b>	<b>(IF Loopback)</b> This test mode invokes an internal IF loop. This is a particularly useful feature, as it is used to perform a quick diagnostic test without having to disturb external cabling. Furthermore, all of the receive configuration parameters are temporarily changed to match those of the transmit side. During an IF Loop, the Tx carrier continues to be transmitted. See <b>Figure 6-3</b> .  When <b>Norm</b> is again selected, all previous values are restored.
<b>Dig↓</b>	<b>(Digital Loopback)</b> This test mode invokes a digital loopback, which loops data at the output of the framer/scrambler on the transmit side and back into the deframer/descrambler on the receive side. If concatenated Reed-Solomon FEC is being used, this is also included in the digital loop. See <b>Figure 6-3</b> .
<b>I/O↓</b>	<b>(Inward/Outward loopback)</b> This test mode invokes two distinct loopbacks: <ul style="list-style-type: none"> <li>• The Inward Loop takes data being received from the satellite direction and passes it directly to the modulator.</li> <li>• Simultaneously, the Outward Loop is invoked, whereby data being fed to the transmit data interface is routed directly back out of the receive data interface. See <b>Figure 6-3</b>.</li> </ul>
<b>RF↓</b>	<b>(RF Loopback)</b> Useful for performing a satellite loopback, this test mode is almost identical to the IF loop mode: All receive configuration parameters are temporarily changed to match those of the transmit side; however, no internal connection is made.  When <b>Norm</b> is again selected, all previous values are restored.
<b>TX-CW</b>	<b>(Transmit CW)</b> Used for measuring phase noise, this test mode forces the modulator to transmit a pure carrier (unmodulated).
<b>TX-1,0</b>	<b>(Transmit an alternating 1,0,1,0 pattern)</b> Used to check the carrier suppression of the Modulator. This test mode forces the modulator to transmit a carrier modulated with an alternating 1,0,1,0 pattern, at the currently selected symbol rate. This causes two discrete spectral lines to appear, spaced at +/- half the symbol rate, about the carrier frequency.  If OQPSK is selected as the modulation type, the test produces a spectral pattern suitable for the measurement of SSB rejection – useful in determining the phase and amplitude accuracy of the modulator.

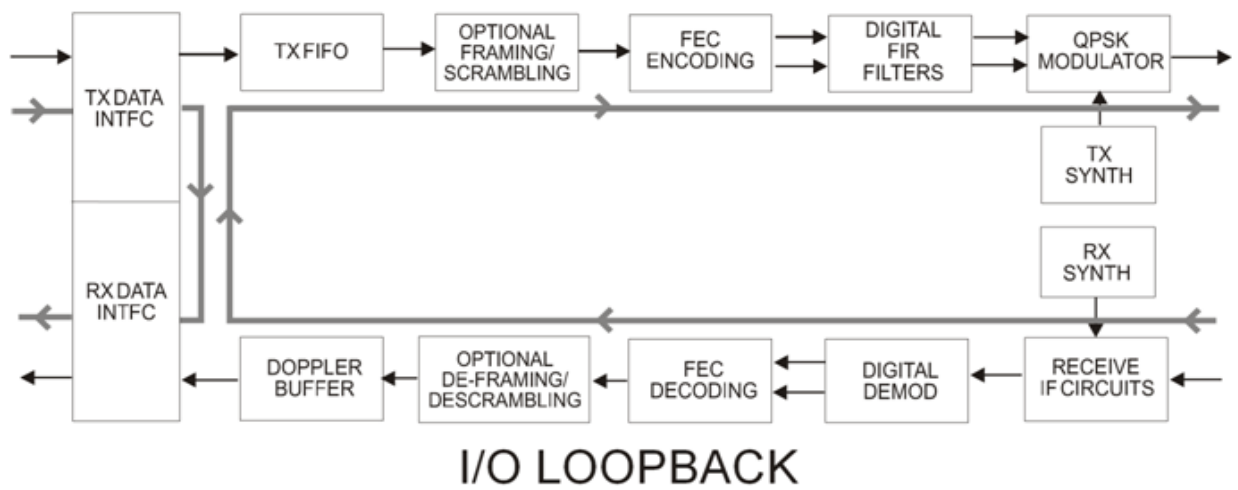
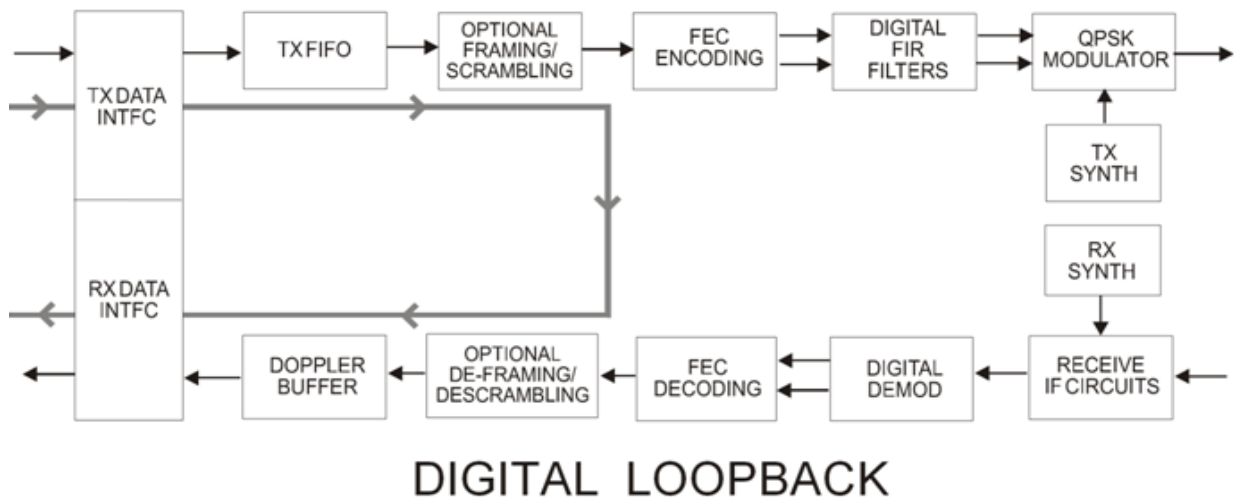
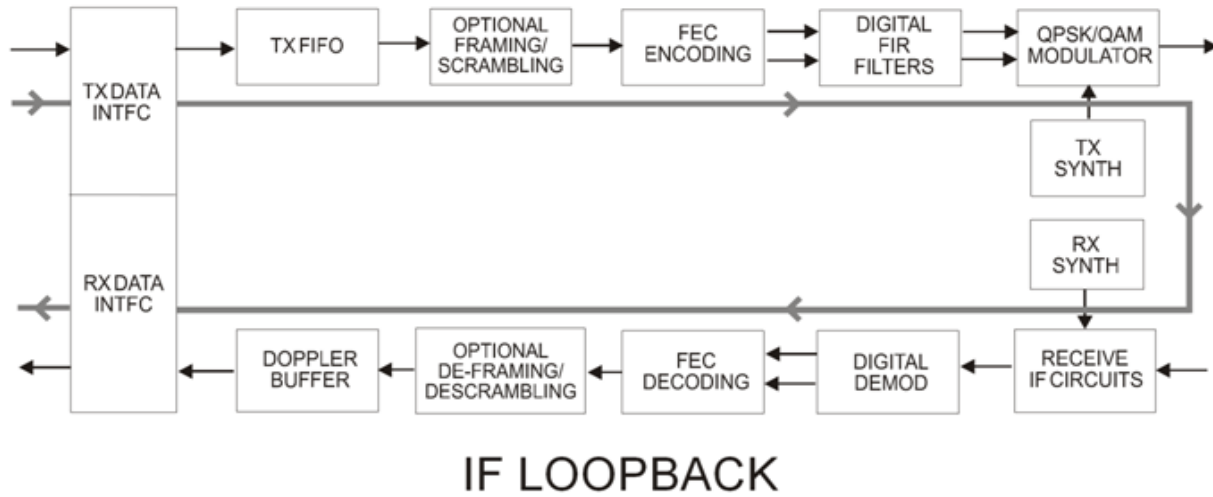

Figure 6-3. Loopback Test Modes

### 6.3.4.2 TEST: BERT



This feature is **UNAVAILABLE** when operating in **CDM-570 Compatible Mode**. See Section 6.2 for further information.

```
BERT: Config Monitor
```

Use the ◀▶ arrow keys to select **Config** or **Monitor**. Press **ENTER**.

#### 6.3.4.2.1 (TEST: BERT) Config

```
Tx: Off Pat: 1:1
Rx: On Pat: 2047
```

Use the ◀▶ arrow keys to select the BERT operational setting, and then use the ▲▼ arrow keys to set the operational setting.

BERT configuration options are as follows:

Parameter	Description
Tx: or Rx:	Off or On
Pat (Pattern Options)	Space, Mark, 1:1, 2047, 2 <sup>15</sup> -1, 2 <sup>23</sup> -1

#### 6.3.4.2.2 (TEST: BERT) Monitor

```
Errs=00000000 Sync: OK
BER=3.35E-07 Reset 1Err
```

This screen displays the ongoing BERT as follows:

Display Line	Parameter	Description
Top	Errs	Displays the number of errors currently tallied in BERT.
	Sync	Displays as OK or Loss.
Bottom	Reset	Select to reset the Errors (Errs) counter to 00000000.
	1Err	Select to insert a 1-bit error in the Tx test pattern.

If you attempt to select **Monitor** from the **(TEST: BERT) Config** screen, and **Rx**, or **both** is **Off**, then the modem displays the following message:

```
BERT machine is OFF
Press CLEAR to exit
```

Press **CLEAR** to return to the **TEST: BERT** menu, and then use the Config: menu

### 6.3.5 SELECT: Info

```
INFO:All Tx Rx Buf Frame
Intfc Rem Msk Ref ID 1:1
```

Use this menu branch to review information on the modem's current configuration. The information provided on these screens is viewable on a **read-only** basis – no editing is possible.

Use the ◀ ▶ arrow keys to select a parameter. Press **ENTER**.

Typical for all nested Info screens, press **ENTER** or **CLEAR** to return to the **SELECT: Info** menu.

#### 6.3.5.1 INFO: All

This screen set allows review and configuration of the modem in its entirety. Once a specific screen displays, press **ENTER** to continue through the remaining displays. To discontinue and return to the **CONFIG: menu**, press **CLEAR**.

As it is with the **CONFIG: All** menu, the availability of information screens is dependent on the active operational settings.

#### 6.3.5.2 INFO: Tx (Transmit)

```
Tx:1140.000 5000.000 TUR
8P 0.95 S EXT -20.0 ON I
```

This screen displays Transmit information as follows:

Display Line	Description
Top Line (from left)	<ul style="list-style-type: none"> <li>Transmit Frequency and Data Rate (NOTE: Due to space limitations, the resolution of displayed frequency is limited to 1 kHz, and data rate to 10 bps)</li> <li>FEC Encoder type (VIT = Viterbi, VRS=Viterbi + Reed-Solomon, TCM = Trellis Coded + Reed-Solomon, TUR = TPC, VFEC = VersaFEC, VersaFEC-2 (Long) = VF2L, VersaFEC-2 (Short) = VF2S, ULL = Ultra Low Latency, UNC = uncoded)</li> </ul>
Bottom Line (from left)	<ul style="list-style-type: none"> <li>Modulation type (Q = QPSK, OQ= OQPSK, B = BPSK, 8P = 8-PSK, 8Q = 8QAM, 16=16-QAM, 8-ARY, 16-ARY, 32-ARY)</li> <li>Code Rate (Unc = Uncoded, 2144 = 21/44, then 5/16, 1/2, 2/3, 3/4, 7/8, 0.95)</li> <li>Scrambler state (S = Scrambler on, N = Scrambler off, I = IESS-315 On)</li> <li>Clocking Mode (INT = internal, EXT = external, LOP = loop, CXE = internal &amp; Clock Extend TxLock E1 mode, CXT = internal &amp; Clock Extend TxLock T1 mode)</li> <li>Output power level</li> <li>Transmit output state (ON = on, OF = off, EO= external off, RT= Rx-Tx Inhibit)</li> <li>TSI state (I = Transmit Spectral Inversion on, N = off)</li> </ul>

### 6.3.5.3 INFO: Rx (Receive)

```
Rx:1140.000 5000.000 TUR
8P 0.95 D BUF +/-32k I
```

This screen displays Receive information as follows:

Display Line	Description
Top Line (from left)	<ul style="list-style-type: none"> <li>Receive Frequency and Data Rate (NOTE: Due to space limitations, the resolution of displayed frequency is limited to 1 kHz, and data rate to 10Hz.)</li> <li>FEC Decoder type (VIT = Viterbi, VRS=Viterbi + Reed-Solomon, TCM = Trellis Coded + Reed-Solomon, TUR = TPC, VFEC = VersaFEC, VersaFEC-2 (Long) = VF2L, VersaFEC-2 (Short) = VF2S, ULL = Ultra Low Latency, UNC = uncoded)</li> </ul>
Bottom Line (from left)	<ul style="list-style-type: none"> <li>Demodulation type (Q = QPSK, OQ= OQPSK, B = BPSK, 8P = 8-PSK, 8Q = 8QAM, 16=16-QAM, 8-ARY, 16-ARY, 32-ARY).</li> <li>Code Rate (Unc = Uncoded, 2144 = 21/44, then 5/16, 1/2, 2/3, 3/4, 7/8, 0.95)</li> <li>Descrambler state (D = Descrambler on, N = Descrambler off, I = IESS-315 On)</li> <li>Clocking Mode (SAT = buffer disabled, BUF = buffer enabled, CXE = internal &amp; Clock Extend RxEnable E1 mode, CXT = internal &amp; Clock Extend RxEnable T1 mode)</li> <li>Demod Sweep Acquisition range</li> <li>RSI state (I = Receive Spectral Inversion on, N = off)</li> </ul>

### 6.3.5.4 INFO: Buf (Buffer)

```
Buffer: Enabled (Tx=Rx)
Size:+/-04096 bits (ENT)
```

This screen reports if the buffer is **Enabled** or **Disabled**; shows the exact clocking mode (**Tx=Rx**, or **Tx<> Rx**); and displays the buffer size.

### 6.3.5.5 INFO: Frame (Framing and EDMAC)

This screen displays the framing mode and whether the modem is EDMAC **Master** or **Slave**, with the appropriate address. Examples are as follows:

```
Framing: Disabled
(ENTER or CLEAR)
```

```
Framing: AUPC-Only,EDMAC2
(ENTER or CLEAR)
```

```
Framing: AUPC+EDMAC2
Master,0240 (ENT or CLR)
```

```
Framing: AUPC+EDMAC
Slave, 0241 (ENT or CLR)
```



---

### 6.3.5.6 INFO: Intfc (Interface)

This screen displays details of the main data port's electrical interface type. When you select **RS422**, **V.35**, or **RS232**, the screen also indicates RTC/CTS operation. Examples are as follows:

```
Interface: RS422 (ENT)
RTS/CTS Loop, No Action
```

```
Interface:G.703 E1-Unbal
HDB3 (ENTER or CLEAR)
```

```
Interface: G.703 T1 B8ZS
533-655 feet(ENT or CLR)
```

---

### 6.3.5.7 INFO: Rem (Remote Control)

This screen reports whether the modem is in **Local** or **Remote** mode; identifies the selected electrical interface type; reports the unit's address; shows the selected baud rate, etc. Examples are as follows:

```
Remote M&C: Monitor Only
(Local Control only)
```

```
Remote M&C: RS485-4Wire
Address: 0001 19200 Baud
```

```
Remote M&C: 100BaseTx
IP Addr: 255.255.255.255
```

Press **ENTER** or **CLEAR** to return to the previous menu.

---

### 6.3.5.8 INFO: Msk (Alarm Mask)

```
Mask: FIFO BPV TAIS RAIS
AGC EbNo BUF Ref BUC LNB
```

This screen displays, in the same format as the **CONFIG: Mask** submenu, which alarms are currently masked. If an alarm is not masked, the display substitutes a blank space at the relevant screen position assigned that item.



When in **G.703 Clock Extended Mode (CEX)**, “**BPV**” appears in place of “**LOS**” to indicate the alarm mask of **G703 Loss of Signal**.

---

### 6.3.5.9 INFO: Ref (Frequency Reference)

```
Frequency Reference:  
Internal 10 MHz (ENTER)
```

This screen displays the configured external frequency reference source for the modem.

---

### 6.3.5.10 INFO: ID

```
Circuit ID: (ENTER)  
24 CHARACTER TST MESSAGE
```

This screen displays the user-defined Circuit ID string that you can compose via the **UTIL: ID** submenu.

---

### 6.3.5.11 INFO: 1:1 (1:1 Redundancy)

```
Redundancy State: Standby  
Serial 1:1 Link: Active
```

- **On the top line:** This screen displays the **Redundancy State** (1:1 or 1:N) as **Online** or **Standby**
- **On the bottom line:** This screen indicates the status of the serial link between the two units as **Active** or **Idle**.

### 6.3.6 SELECT: Save/Load

```
Save/Load Configuration:  
Save Load (◀ ▶, ENTER)
```

This menu branch allows the saving (storage) or loading (retrieval) of up to 10 different modem configurations (0 through 9) in the non-volatile memory of the modem. Use the ◀ ▶ arrow keys to select **Save** or **Load**. Press **ENTER**.

---

#### 6.3.6.1 (Save/Load Configuration:) Save

Use the ▲ ▼ arrow keys to select the location you wish to **Save** (store) the current configuration. Press **ENTER**. Locations 0 through 9 are available.

**Using Location 9 as an example:** If you select **Save** and the chosen location is empty, the screen appears as follows:

```
Save Config to Loc: 9  
Empty (▲ ▼)
```

If the selected location already contains data, then the time and date stamp of the previously stored configuration displays for identification purposes, as this example shows:

```
Save Config to Loc: 9
11:10:29 23/12/13 (▲ ▼)
```

If the selected location does not contain a previously stored configuration, the screen appears as this example shows:

```
Your Configuration has
been Saved to Loc 9 (ENT)
```

Press **ENTER** or **CLEAR** to return to the previous menu.

If the selected location does contain a previously stored configuration, the modem prompts you to overwrite the location. The screen appears as this example shows:

```
Loc 9 Contains Data!
Overwrite? NO YES (◀ ▶)
```

Use the ◀ ▶ arrow keys to select **No** or **Yes**. Press **ENTER**. Select **Yes**, if prompted, to overwrite the selected location's existing configuration.

Once you properly save a modem configuration, press **ENTER** or **CLEAR** to return to the previous menu.

---

### 6.3.6.2 (Save/Load Configuration:) Load

Use the ▲ ▼ arrow keys to select the location of the modem configuration that is to be retrieved for **loading**. Press **ENTER**. Locations **0** through **9** are available.

**Using Location 9 as an example:** If you select **Load** and a configuration is stored at the chosen location, the time and date stamp of the previously stored configuration displays for identification purposes, as this example shows:

```
Load Config from Loc: 9
11:10:29 23/12/13 (▲ ▼)
```

If the selected location contains no configuration data, the screen appears as this example shows:

```
Load Config from Loc 9
Empty (▲ ▼)
```

Use the ▲ ▼ arrow keys to select another location from which to load a configuration (e.g., Location 8). Press **ENTER**. If the newly selected location contains valid data, the display appears as this example shows:

```
New Config has been
Loaded from Loc 8 (ENT)
```

Once you properly **load** a modem configuration, press **ENTER** or **CLEAR** to return to the previous menu.

### 6.3.7 SELECT: Util (Utility)

```
UTIL: Buf Clock Ref CMO  
ID 1:1 VFD FW FAST CID
```

Use the ◀ ▶ arrow keys to select a parameter. Press **ENTER**.



See Sect. 0 for use of the CMO (CDM-570 Compatible Mode) feature.

---

#### 6.3.7.1 UTIL: Buf (Buffer Re-CENTER)

```
Press ENTER to Re-CENTER  
the Receive Buffer
```

Press **ENTER** to force re-centering of the Plesiochronous/Doppler buffer.

---

#### 6.3.7.2 UTIL: Clock (Set Real-time Clock)

```
Edit Real-Time Clock:  
12:00:00 24/04/13 (◀ ▶,▲ ▼)
```

To edit the time and date settings of the real-time clock, use the ◀ ▶ arrow keys to select the digit to edit. Then, use the ▲ ▼ arrow keys to change that digit. Press **ENTER**.



In accordance with European convention, the date appears in DAY-MONTH-YEAR format.

---

#### 6.3.7.3 UTIL: Ref (Reference)

```
Internal Freq Ref:Adjust  
Warm-up delay (◀ ▶,ENTER)
```

Use the ◀ ▶ arrow keys to select **Adjust** or **Warm-up delay**. Press **ENTER**.

### 6.3.7.3.1 (Internal Freq Ref:) Adjust

```
Internal 10 MHz Freq Ref  
Fine Adjust: +017 (◀ ▶, ▲ ▼)
```

For fine adjustment of the Internal 10 MHz reference oscillator, use the ▲ ▼ arrow keys to edit the value. The valid range of values is from **-999** to **+999**.



**In order to facilitate adjustment, the value updates in real time as the digits increment/decrement. You do not need to Press the ENTER key.**

**The numbers displayed here do not correspond to an exact frequency increment. You should perform this fine adjustment while using an external frequency counter, connected either for:**

- **The internal 10 MHz reference, if you have internal access to the equipment,**
- or
- **The Tx Output, set for CW, 0 dBm output level, and an exact center frequency (e.g., 1000 MHz).**

### 6.3.7.3.2 (Internal Freq Ref:) Warm-up Delay

```
Warm-up delay: Disable  
Enable (◀ ▶, ENTER)
```

Because the modem uses a high-stability oven-controlled 10 MHz reference Oven-controlled Crystal Oscillator (OCXO), the modem requires a finite time period for the oven to reach operating temperature. Consequently, when the modem first powers up, a frequency error as great as  $2 \times 10^{-6}$  will occur, and it may take up to 2 minutes before the frequency settles to its correct value. This affects the Tx synthesizer (and hence the Tx output frequency), the Rx synthesizers, and the generation of the Internal Tx baseband clock.

For a modem operating on its own, this may not be a problem, but if you use the 10 MHz reference signal to drive an externally connected BUC, the frequency error at the RF output may be large, particularly at Ku- or Ka-Band. In order to avoid this problem, you may choose to enable a warm-up delay, which suspends normal operation of the modem until the operating temperature of the OCXO stabilizes.

Warm-up delay is not fixed. Instead, the modem uses an intelligent algorithm to minimize this delay, under all circumstances. The modem uses its internal temperature sensor and knowledge of how long you have powered down the modem to determine the duration of the warm-up delay period.

**For example:** The worst case occurs when the modem has been powered down sufficiently long that the modem has achieved ambient temperature, and the external temperature is at the lowest value possible. Under such conditions, the modem will take two minutes to warm-up.

If the external temperature is hot, and you power down the modem only to power up again a short time later, the warm-up period is very short, perhaps only several seconds.

Use the ◀ ▶ arrow keys to **Disable** or **Enable** the warm-up delay feature. Press **ENTER**.  
If you select **Disable**, the modem powers up, and goes into normal operational service **without delay**.

If you select **Enable**, one of the following screens displays when the modem powers up:

**CDM/R-570ALunit:**

```
Comtech CDM/R-570ALModem
Ref Warming-up: 045
```

**CDM-570A unit:**

```
Comtech CDM-570A Modem
Ref Warming-up: 045
```

The bottom line counts down, in seconds, the time remaining for the warm-up period. **During this period, the Tx Carrier is deliberately muted**. At the end of the warm-up period, the bottom line reverts to the 'normal' opening screen display (i.e., it displays the Firmware version), and the modem **ENTERS** into its normal operational state.



**Bypass (override) the warm-up period at any time by pressing the CLEAR key.**

#### 6.3.7.4 UTIL: CMO

```
Compatible Mode: CDM-570
CDM-570A      (◀ ▶, ENTER)
```

Use the ◀ ▶ arrow keys to select the modem model type. Press **ENTER**.

#### 6.3.7.5 UTIL: ID (Circuit ID)

```
Edit Circuit ID: (◀ ▶, ▲ ▼)
-----
```

A 24-character Circuit ID string may be composed on the bottom line only. To compose the Circuit ID string, first use the ◀ ▶ arrow keys to select a character to edit. Then, use the ▲ ▼ arrow keys to edit that character. Press **ENTER**.

Use the following characters to compose a Circuit ID string or (a maximum length of 24 characters of allowed):

[Space] ( ) \* + - . / 0 through 9 and A through Z.

##### 6.3.7.5.1 UTIL: 1:1 (Manual 1:1 Switchover)

```
1:1 Manual/Auto Force
```

If this modem is the online unit in a 1:1 redundant configuration, press **ENTER** to force the unit into **Standby mode**. Otherwise, press **CLEAR** to exit this menu and return to the previous menu without causing the switchover.

---

### 6.3.7.6 UTIL: VFD (Video Fluorescent Display Brightness)

```
Edit Display Brightness:  
100%          (▲ ▼, ENTER)
```

To adjust the display brightness, use the ▲ ▼ arrow keys to select **25%**, **50%**, **75%**, or **100%**. Press **ENTER** when the brightness is suitable.

---

### 6.3.7.7 UTIL: FW (Firmware Images)



Chapter 4. UPDATING FIRMWARE



**THESE MENUS ARE INTENDED FOR DIAGNOSTIC PURPOSES ONLY. DO NOT CHANGE AN IMAGE UNLESS OTHERWISE INSTRUCTED BY COMTECH EF DATA PRODUCT SUPPORT.**

```
Firmware Images:  
Info Select   (◀ ▶, ENTER)
```

The modem can store two complete firmware images. This series of submenus display information about the modem internal firmware, and allows selection of which firmware image loads upon the next unit reboot.

Use the ◀ ▶ arrow keys to select **Info** or **Select**. Press **ENTER**.

#### 6.3.7.7.1 (UTIL: FW Images) Info



The screen shots that follow are provided for example only. Your displays may differ depending on your active firmware loads.

```
Firmware Info: Bootrom  
Image#1   Image#2   PaP
```

Use the ◀ ▶ arrow keys to select a parameter. Press **ENTER**.

#### (UTIL: FW Info) Bootrom

```
Bootrom:          MM/DD/YY  
FW-0020684*      #.#.#
```

#### (UTIL: FW Info) PaP

```
PaP:              MM/DD/YY  
FW-0020781*      #.#.#
```

This screen is available only when the optional Packet Processor is installed:

For **Image#1** or **Image #2**, each image is further broken down to display component-level firmware information.

### (UTIL: FW Info) Image #X

Where **Image#X** denotes **Image#1** or **Image#2**:

```
Image#X: Bulk   Main-FPGA
App Legacy-FPGA CnC-FPGA
```

Use the ◀ ▶ arrow keys to select a parameter, and then press **ENTER** to display that firmware component's information. For example, when you select **Bulk**, a screen similar to the following displays:

```
Bulk#X:          10/17/14
FW-0020683C     1.2.1
```

### 6.3.7.7.2 (UTIL: FW Images) Select

```
Current Active Image: #1
Next Reboot Image: #1 #2
```

The **top line** displays the currently loaded (active) image.

On the **bottom line**, use the ◀ ▶ arrow keys to select the image that will be loaded and active upon the next unit reboot.

---

### 6.3.7.8 UTIL: FAST (FAST Code Options)



#### Chapter 5. FAST ACTIVATION PROCEDURE

```
FAST:Cnfg View (HW0.XXX)
MainBoard S/N: 123456789
```

**FAST** (Fully Accessible System Topology) provides the means to enable new options in the modem. Contact Comtech EF Data during normal business hours to obtain the FAST Access Code for the desired option.

The **FAST** menu allows you to configure (enter) a new FAST Access Code into the modem, view which options are currently installed, and enable Demo Mode. This screen also identifies the Hardware Revision Number on the top line, and the Main Board Serial Number on the bottom line.



**The MainBoard Serial Number is a unique identifier for the FAST upgrade process and is different from the Chassis Serial Number. This number is required in order to obtain a new FAST Access Code from Comtech EF Data Product Support.**

Use the ◀ ▶ arrow keys to select **Cnfg** or **View**. Press **ENTER**.



### 6.3.7.8.1 (UTIL: FAST) Cnfg (FAST Configuration)

```
FAST Configuration:
Edit Code      Demo Mode
```

Use the ◀ ▶ arrow keys to select **Edit Code** or **Demo Mode**. Press **ENTER**.

#### (UTIL: FAST) FAST Configuration → Edit Code



See Chapter 5. FAST ACTIVATION PROCEDURE for further information.

```
FAST: Edit register 2
00000000000000000000 ENT
```

#### (UTIL: FAST) FAST Configuration → Demo Mode

```
FAST Demo Mode: Off On
2592000 seconds remain
```

Use the ◀ ▶ arrow keys to select FAST Demo Mode as **Off** or **On**. Press **ENTER**.

Demo Mode allows access to ALL modem FAST options for 2592000 seconds (30 calendar days). Once you turn Demo Mode **On**, the available time decrements and the bottom line of the display shows the number of available seconds remaining for the free Demo Mode. You may turn Demo Mode **Off** and **On** as needed until this time expires.

When the Demo period expires, the following message displays:

```
FAST Demo Mode: Off On
Demo Period Expired
```



**IF THE DEMO MODE STATE (OFF/ON) IS CHANGED, OR IF DEMO MODE IS ENABLED AND THE TIMER EXPIRES, THE MODEM FIRMWARE WILL REBOOT AUTOMATICALLY AFTER 5 SECONDS.**

**NOTE THAT VALIDATION OF AUTHORIZED FAST OPTIONS OCCURS ON AUTO-REBOOT; IF AN INVALID CONFIGURATION IS FOUND, THE MODEM CONFIGURATION WILL RESET TO ITS FACTORY DEFAULT VALUES.**

### 6.3.7.8.2 (UTIL: FAST) View

```
View Options: 03      (▲ ▼)
150W BPSU      Not Installed
```

Use the ▲ ▼ arrow keys to view which **FAST** options are currently installed or available.

The **top line** displays the Option Number.

The **bottom line** provides a self-explanatory description for that option, along with its current operational status (“**Y**” (Installed) or “**N**” (Not Installed)). Options listed as “**N**” are available for purchase from Comtech EF Data.

AVAILABLE FAST OPTIONS		
Option Number	Display Message	Option Type
01	150W BUC Power Supply	HARDWARE
02	100W BUC Power Supply	HARDWARE
03	10.239 Mbps data rate	FAST
04	RS Codec	FAST
05	TPC Codec	FAST
06	TPC 0.95 Card Present	HARDWARE
07	RESERVED	-
08	Tx VFEC 10.239 Mbps	FAST
09	8PSK/8QAM	FAST
10	16-QAM	FAST
11	Tx ROF 10.239 Mbps	FAST
12	G.703 Clock Extension	FAST
13	Carrier ID	FAST
14	CnC Card Present	HARDWARE
15	Full CnC 10.239 Mbps	FAST
16	Frac CnC datarate	FAST
17	CnC APC	FAST
18	PaP Card Present	HARDWARE
19	IP 3xDES Encryption	FAST
20	IP Header Compression	FAST
21	IP Payload Compression	FAST
22	IP QoS	FAST
23	Vipersat	FAST
24	VFS (Vipersat File Streamer)	FAST
25	IP-ACM 3000 ksps	FAST
26	Expansion Card (VsaFEC2 is displayed when VF2 card is installed)	HARDWARE

### 6.3.7.9 UTIL: CID (Carrier ID)



#### Appendix R. CARRIER ID (DVB-CID METACARRIER®)



**BEFORE USING CARRIER ID, BE SURE TO USE THIS MENU TO FIRST CREATE A METACARRIER CUSTOM MESSAGE OF 24 CHARACTERS OR LESS.**

Note that in accordance with the DVB specification, Carrier ID is only available when the Transmit symbol is greater than, or equal to 128 ksps.

Use the ▲▼ arrow keys to select the Carrier ID (MetaCarrier) function as **OFF** or **ON**.

```
CarrierID: Off      ◀ ▶ ◆
```

After selecting **ON**, the appearance of this menu screen updates as follows:

```
CarrierID: On      ◀ ▶ ◆
Lat Long Phone# Message
```

Use the ◀▶ arrow keys to select a parameter. Press **ENTER**.

#### 6.3.7.9.1 UTIL: CID (Carrier ID) Latitude

```
CarrierID Latitude:
 33°25.32'N (◀ ▶ ◆, ENT)
```

Set the Carrier ID Latitudinal Coordinate by using the ◀▶ arrow keys to select an alphanumeric character space. Then, use the ▲▼ arrow keys to change that character. Press **ENTER**.

The unit limits the selection of available alphanumeric characters as shown:

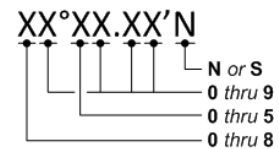

#### 6.3.7.9.2 UTIL: CID (Carrier ID) Longitude

```
CarrierID Longitude:
111°58.28'W (◀ ▶ ◆, ENT)
```

Set the Carrier ID Longitudinal Coordinate by using the ◀▶ arrow keys to select an alphanumeric character space. Then, use the ▲▼ arrow keys to change that character. Press **ENTER**.

The unit limits the selection of available alphanumeric characters as shown:

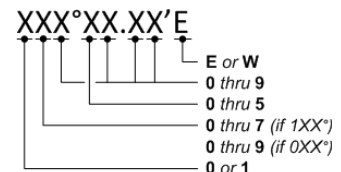

### 6.3.7.9.3 UTIL: CID (Carrier ID) Phone#

```
CarrierID Phone #: ◀ ▶ ◆  
+15555555555
```

Edit the Carrier ID unit Phone Number on the bottom line, by using the ◀ ▶ arrow keys to select an alphanumeric character space. Then, use the ▲ ▼ arrow keys to change that character. Press **ENTER**.

The unit limits the Telephone Number to 18 alphanumeric characters or less, and limits the selection of available characters as follows:

[Space] 0-9 and x

### 6.3.7.9.4 UTIL: CID (Carrier ID) Message

```
CarrierID Message: ◀ ▶ ◆  
Custom CarrierID Message
```

Compose a MetaCarrier Custom Message on the bottom line by using the ◀ ▶ arrow keys to select an alphanumeric character space. Then, use the ▲ ▼ arrow keys to change that character. Press **ENTER**.

You may use all printable ASCII characters, from [Space](0x20) through tilde ~ (0x7E), to compose a MetaCarrier Custom Message of 24 characters or less.

### 6.3.8 SELECT: ODU (CDM-570A 70/140 MHz Unit ONLY)



See Chapter 10. CDM-570A/570AL ODU (TRANSCEIVER, BUC, LNB) M&C OPERATIONS for complete details about this modem-specific menu branch.

```
Transceiver Control:  
Disable Enable (◀ ▶, ENTER)
```

Use this menu branch to monitor and control a Comtech EF Data RF Transceiver (CSAT-5060 or KST-2000A/B), if connected.

# Chapter 7. ETHERNET-BASED REMOTE PRODUCT MANAGEMENT

## 7.1 Overview

Ethernet-based Remote Product Management of the CDM-570A/570AL is available using one of two rear panel RJ-45 10/100 BaseT Ethernet ports:

- The 'M&C 100' 10/100 Ethernet port (for units without the optional High-Performance Packet Processor)

–or–

- The 'Traffic 100' 10/100 Ethernet port (for units equipped with the optional Packet Processor).

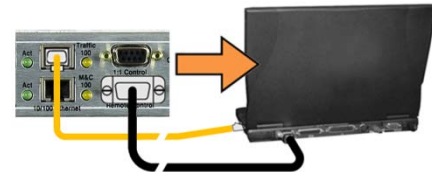
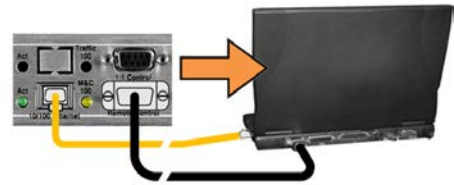

**1. YOU MAY PROCEED WITH ETHERNET-BASED REMOTE PRODUCT MANAGEMENT (SNMP, TELNET, OR WEB SERVER) ASSUMING THAT:**

- The CDM-570A/570AL is operating with the latest version firmware files.
- The CDM-570A/570AL is connected to a user-supplied, Windows-based PC, and:
  - The PC serial port is connected to the CDM-570A/570AL rear panel 'Remote Control' port with a user-supplied 9-pin serial cable.
  - The PC Ethernet port is connected either to the CDM-570A/570AL rear panel 'M&C 100' or the 'Traffic 10/100' BaseT Ethernet port with a user-supplied hub, switch, or direct Ethernet cable connection.
  - The user PC is running a terminal emulation program (for operation of the CDM-570A/570AL Serial Interface or Telnet CLI) and a compatible Web browser (for operation of the CDM-570A HTTP (Web Server) Interface).

- The CDM-570A/570AL Ethernet Traffic IP Address has been noted and the firmware has been identified using either the CDM-570A/570AL Serial Interface or the CDM-570A HTTP Interface 'Admin | Access' page, respectively.
2. **USE OF THE ETHERNET-BASED SNMP INTERFACE IS RECOMMENDED ONLY FOR ADVANCED USERS. ALL OTHER USERS ARE STRONGLY ENCOURAGED TO USE THE CDM-570A HTTP INTERFACE FOR MONITOR AND CONTROL (M&C) OF THE CDM-570A/570AL.**
  3. **Unless otherwise specified, "CDM-570A/570AL" is used throughout this chapter to refer to the CDM-570A (70/140 MHz) and CDM-570AL or CDMR-570AL (L-Band) Satellite Modems.**

### 7.1.1 Ethernet Management Interface Protocols

The user PC facilitates access to Ethernet-based remote monitor and control (M&C) of the CDM-570A/570AL through separately-operated protocols:

- **Simple Network Management Protocol (SNMP).** This *non-secure interface* requires a user-supplied Network Management System (NMS) and a user-supplied Management Information Base (MIB) File Browser.
- **Telnet Interface.** This requires use of a user-supplied terminal emulation program such as HyperTerminal (recommended for use with the serial-based remote control protocol) or PuTTY (recommended for use for use with the Packet Processor Telnet Command Line Interface), installed on the user PC.
- **The CDM-570A HTTP (Web Server) Interface.** This *non-secure interface* requires a compatible user-supplied Web browser such as Internet Explorer.

---

## 7.2 SNMP Interface

An SNMP is an Internet-standard protocol for managing devices on IP networks. An SNMP managed network consists of three key components:

- **The managed device.** This includes the CDM-570A/570AL Satellite Modem.
- **The SNMP Agent.** The software that runs on the CDM-570A/570AL. The CDM-570A SNMP Agent supports both **SNMPv1** and **SNMPv2c**.
- **The user-supplied NMS.** The software that runs on the manager.

## 7.2.1 Management Information Base (MIB) Files

MIB files are used for SNMP remote management of a unique device. A MIB file consists of a tree of nodes called Object Identifiers (OIDs). Each OID provides remote management of a particular function. These MIB files should be compiled in a user-supplied MIB Browser or SNMP Network Monitoring System server. The following MIB files are associated with the CDM-570A/570AL:

MIB File/Name (where 'x' is revision letter)	Description
<b>FW10874-2x.mib</b> ComtechEFData MIB file	ComtechEFData MIB file gives the root tree for ALL Comtech EF Data products and consists of only the following OID: <b>Name:</b> comtechEFData <b>Type:</b> MODULE-IDENTITY <b>OID:</b> 1.3.6.1.4.1.6247 <b>Full path:</b> iso(1).org(3).dod(6).internet(1).private(4).enterprises(1).comtechEFData(6247) <b>Module:</b> ComtechEFData
<b>FW-0020760x.mib</b> CDM-570A MIB file -or- <b>FW-0020761x.mib</b> CDM/R-570AL MIB file	MIB file consists of all of the OIDs for management of the CDM-570A/570AL modem functions
<b>FW-0020786x.mib</b> CDM-570A/570AL Packet Processor MIB file	MIB file consists of all of the OIDs for management of the CDM-570A/570AL optional Packet Processor functions
<b>FW-0020762x.mib</b> CDM-570A Traps MIB file -or- <b>FW-0020763x.mib</b> CDM/R-570AL Traps MIB file	Trap MIB file is provided for SNMPv1 traps common for base modems.
<b>FW10874-6x.mib</b> CDM/R-570AL BUC/LNB MIB file	L-Band unit MIB file consists of all of the OIDs for management of the BUC and LNB.
<b>FW10874-7x.mib</b> CDM/R-570AL BUC/LNB Traps MIB file	L-Band unit Trap MIB file is provided for BUC and LNB SNMPv1 traps
<b>FW10874-8x.mib</b> CSAT-5060 MIB file	MIB file consists of all the OIDs for management of the CSAT-5060 Transceiver connected to the CDM-570A modem through FSK.
<b>FW10874-9x.mib</b> KST-2000A/B MIB file	MIB file consists of all the OIDs for management of the KST-2000A/B Transceiver connected to the CDM-570A modem through FSK.

## 7.2.2 SNMP Community Strings



**CAUTION – In SNMP v1/v2c, the SNMP Community String is sent unencrypted in the SNMP packets. Caution must be taken by the network administrator to ensure that SNMP packets travel only over a secure and private network if security is a concern.**

The CDM-570A/570AL uses Community Strings as a password scheme that provides authentication before gaining access to the CDM-570A/570AL Agent MIBs. They are used to authenticate users and determine access privileges to the SNMP Agent.

Type the SNMP Community String into the user-supplied MIB Browser or Network Node Management software.

Three Community Strings are defined for SNMP access:

- **Read Community**      **default = public**
- **Write Community**    **default = private**
- **Trap Community**     **default = comtech**



1. **For proper SNMP operation, the CDM-570A MIB files must be used with the associated version of the CDM-570A/570AL Satellite Modem M&C. Refer to the CDM-570A FW Release Notes for information on the required FW/SW compatibility.**
2. **Maximum number of characters for community strings shall not exceed 20. All printable ASCII characters, except '\ ' and '~' are allowed. No trailing spaces are permitted for community strings.**

### 7.2.3 SNMP Traps

The CDM-570A/570AL has the ability to send out SNMP traps when certain events occur in the modem. For example, when the CDM-570A/570AL boots it sends out a coldstart trap and three linkup traps, one for each interface that is brought up. The CDM-570A/570AL also sends out traps when an alarm or a fault occurs in the modem. These include unit faults, TX faults, and RX faults. A trap is sent both when a fault occurs and is cleared.

The CDM-570A/570AL supports both SNMPv1 traps and SNMPv2 notifications. The style of traps that is sent by the CDM-570A/570AL sends can be configured using the `cdmipSnmptapVersion` OID. The following tables list the MIB-II v1traps/v2 notifications that the modem supports:

#### CDM-570A/570AL MIB-II SNMPv1 traps:

Cold Start	1
Link Up	4
Authentication Failure	5

#### CDM-570A/570AL MIB-II SNMPv2 notifications:

Cold Start	1.3.6.1.6.3.1.1.5.1
Link Up	1.3.6.1.6.3.1.1.5.4
Authentication Failure	1.3.6.1.6.3.1.1.5.5



The following tables list the Alarms and Faults v1 traps / v2 notifications that the modem supports.

**CDM-570A/570AL Alarms and Faults SNMPv1 traps:**

cdm570aUnitAlarm	6247241
cdm570aTxTrafficAlarm	6247242
cdm570aRxTrafficAlarm	6247243
cdm570aLODUAlarm	6247244

**CDM-570A/570AL Alarms and Faults SNMPv2 notifications:**

cdm570aUnitAlarm	1.3.6.1.4.1.6247.85.1.3.1.1
cdm570aTxTrafficAlarm	1.3.6.1.4.1.6247.85.1.3.1.2
cdm570aRxTrafficAlarm	1.3.6.1.4.1.6247.85.1.3.1.3
cdm570aLODUAlarm	1.3.6.1.4.1.6247.85.1.3.1.4



**The SNMP agent supports both SNMPv1 and SNMPv2c. The “Traps” file only needs to be compiled if SNMPv1 traps are to be used.**

## 7.2.4 MIB-II

The CDM-570A/570AL agent implements **RFC 1213** (Request for Comment No. 1213, Management Information Base for Network Management of TCP/IP-based Internets: MIB-II, McCloughrie/ Rose, March 1991). This is known as “MIB-II” or “Public MIB support.” The agent implements the following groups:

Group	Comments
System Group	Mandatory for RFC 1213
Interface	Mandatory for RFC 1213
IP	Mandatory for RFC 1213
ICMP	Mandatory for RFC 1213
TCP	Mandatory for RFC 1213
UDP	Mandatory for RFC 1213
SNMP	Mandatory for RFC 1213
Address Translation Group	Implemented but depreciated in MIB-II
EGP	Not applicable

**For detailed OID information please refer to the actual MIB file.**

## 7.2.5 Private MIB

The CDM-570A SNMP implements common modem MIBs that contain all the modem specific parameters common to the CDM-570A/570AL. In addition, the L-Band SNMP also implements a BUC and LNB MIB for RF parameters.



**Whenever modifying the Modulator or Demodulator parameters by SNMP, it is important that the variables must be executed in the following order:**

1. **FEC**
2. **Modulation or Demodulation**
3. **Code Rate**
4. **Data Rate**

**For detailed OID information, refer to the actual MIB file.**

---

## 7.3 Telnet Interface

Telnet connection is allowed in both Serial remote mode and Ethernet remote mode. The Telnet interface requires login at the **Administrator** and **Read/Write** User Access Levels. Once logged into the Telnet interface as the Administrator, the modem provides a Telnet interface for two primary functions:

- M&C of equipment (e.g., modem, ODU (transceiver, BUC, LNB)) via Remote Control protocol commands and queries.



### **Chapter 8. SERIAL-BASED REMOTE PRODUCT MANAGEMENT**

- When the optional Packet Processor is INSTALLED, M&C using the Packet Processor Serial or Telnet Command Line Interface (CLI).



### **Chapter 9. OPTIONAL PACKET PROCESSOR – SERIAL/TELNET CLI OPERATION**

### 7.3.1 Telnet Operation via HyperTerminal

There is a disadvantage when using Windows Command-line as a Telnet client. Since Command-line cannot translate a '\r' (i.e., carriage return or "CR") to a '\r\n' (i.e., CR+line feed "LF") for the messages coming from Telnet Server, any multi-line Target-to-Controller response (e.g., the response to the FRW? query) will be displayed as one line, with the latter lines overwriting the previous lines.

In order to view the full response messages, Comtech EF Data recommends use of the HyperTerminal terminal emulation program, configured as a Telnet client.

Configure HyperTerminal as follows:

- Make sure that your connection is made using **TCP/IP (Winsock)** instead of COM1 or COM2, as shown at the near right.
- The **Host address** is the modem's Traffic/Management IP Address in the form **xxx.xxx.xxx.xxx**.
- The **Port number** must be **23** when the optional Packet Processor is **INSTALLED**, or **7023** when using a Base Modem *without* Packet Processor.
- ASCII Setup (File → Properties → Settings → ASCII Setup): Check the "**Send line ends with line feeds**" option in the *ASCII Sending* section, and the "**Append line feeds to incoming line ends**" option in the *ASCII Receiving* section, as shown at the far right.

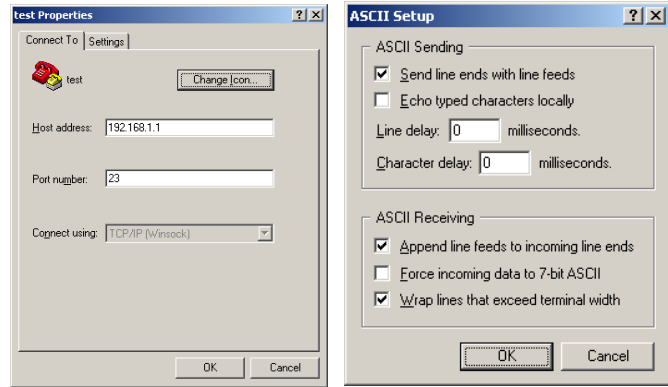

An example of login and remote command/query execution, when using HyperTerminal as the Telnet interface, is shown here:

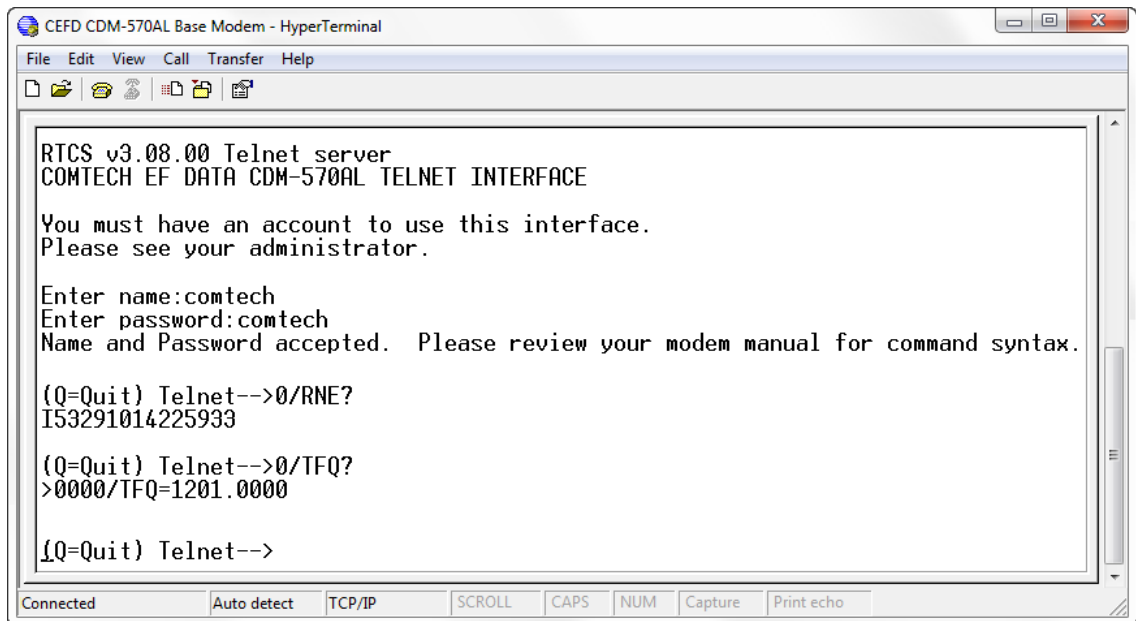

## 7.4 CDM-570A HTTP (Web Server) Interface

A user-supplied Web browser allows the full M&C of the CDM-570A/570AL from its HTTP Interface. This *non-secure* embedded Web application is designed for, and works best with, Microsoft Internet Explorer Version 7.0 or higher.

### 7.4.1 Operational Features

#### 7.4.1.1 User Login

Type the CDM-570A/570AL Ethernet Traffic IP Address (shown in this example as *http://192.168.1.11*) into the **Address** area of the user PC Web browser:



The login window, similar to the example shown here, opens. Enter the assigned **User Name** and **Password**. The CDM-570A HTTP Interface default user names and passwords are as follows:

- **Admin**                                    **comtech/comtech**
- **Read/Write**                            **opcenter/1234**
- **Read-only**                              **monitor/1234**



HTTP Login User Access Levels are further defined as follows:

Admin User	Read/Write User	Read-only User
Full Access to all web pages	No Access to Admin pages	No Access to Admin pages
	Full Access for all other web pages	View Only Access for all other web pages



**If login is attempted and remote control is set to either Local or Remote mode, access is prohibited and the following error message displays in the browser window:**

**Modem Remote Control is not in Ethernet mode.**

[Enable Ethernet Mode](#)

**To properly access the CDM-570A HTTP Interface, configure remote control access for the unit to Ethernet mode. Click [Enable Ethernet Mode].**

Alternately, from the CDM-570A/570AL front panel, use the ◀ ▶ and ▲ ▼ arrow keys to first navigate to the remote control configuration menu, and then select **Ethernet mode** (press **ENTER** when done):

**SELECT: CONFIG ▶ Rem ▶ Ethernet**

Once remote control access is configured and login is successful, the CDM-570A 70/140 MHz or L-Band HTTP Interface “splash page” appears:

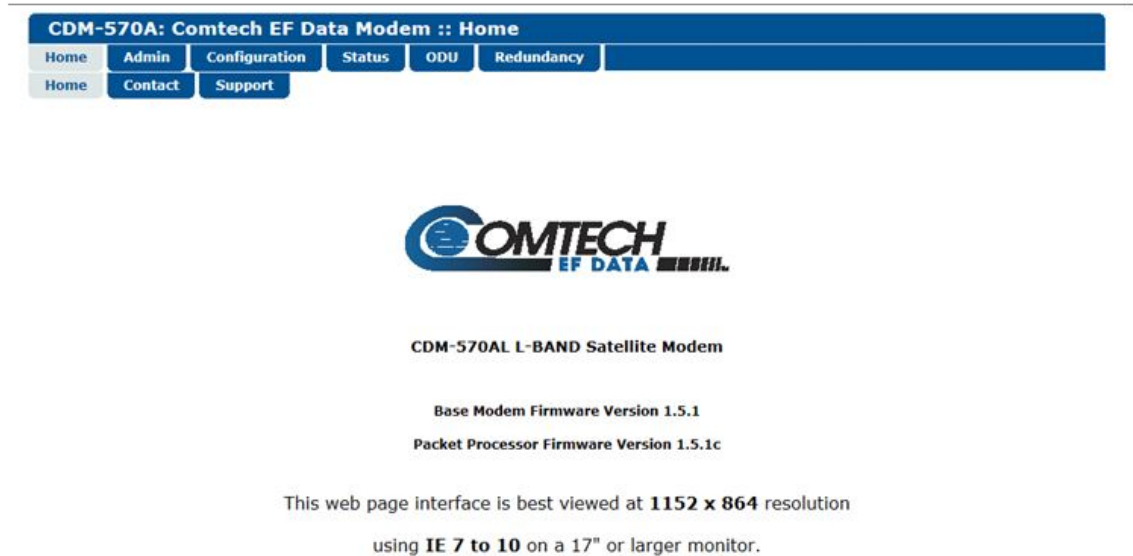

### 7.4.1.2 Navigation

The CDM-570A HTTP Interface features navigation tabs located at the top of each page. After you click a navigation tab, you may click an available primary page tab. In turn, any nested tabs appear for further selection.



This manual uses a naming format for all pages to indicate the depth of navigation needed to view the subject page: “**Top Level Tab | Primary Page Tab (where needed) | Nested Page Tab**”.

**For example**, “**Admin | SNMP**” instructs you to “*first* click the top-level ‘Admin’ navigation tab; *then*, click the nested ‘SNMP’ page tab.

### 7.4.1.3 Page Sections

Each page features one or more sections. The title at the top of each page or page section indicates its function. Each section can feature editable fields, action buttons, and **read-only** displays that are specific to that function.

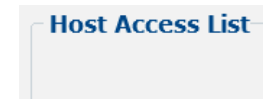

This manual explains each Web page on a **per-page, per-section** basis.

### 7.4.1.4 Action Buttons

Action buttons are important in the CDM-570A HTTP Interface. Click an action button to do one of these tasks:



- Reset changed parameters to remove **unsaved** changes.
- Permanently save changes.
- Refresh the page with current data.



**If you edit a field, make sure to click the action button before you leave the page. If you go to another page without first clicking the action button, your changes are not saved.**

### 7.4.1.5 Drop-down Lists

A drop-down list lets you choose from a list of selections. Left-click the drop-down button to open the list. Then, left-click on an item to select that choice.



**When an optional FAST feature is not available, its associated drop-down list appears dimmed and is non-selectable.**

### 7.4.1.6 Text or Data Entry

Text boxes let you type data into a field. An action button may be associated with a single text box, or a group of text boxes. For any text box, left-click anywhere inside the box, type the desired information into that field, and be sure to press **[ENTER]** when done.

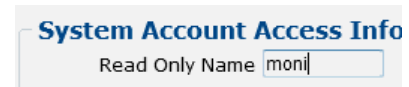

Click the related action button to save the data.



**If you edit any field, make sure to click the action button before you leave the page. If you go to another page without first clicking the action button, your changes are not saved.**

## 7.4.2 CDM-570A HTTP Interface – Menu Tree

**Figure 7-1** shows the HTTP Interface common to both the CDM-570A and CDM/R-570AL modems. Beyond the top-level row of navigation tabs (shown in blue), available nested navigation tabs (shown in green or yellow) afford more specific functionality.



Make sure to read the important notes that follow in Sect. 7.4.2.1 for conditions that may apply to the availability and operation of these individual pages. Such operational restrictions are also noted through the remainder of this chapter.

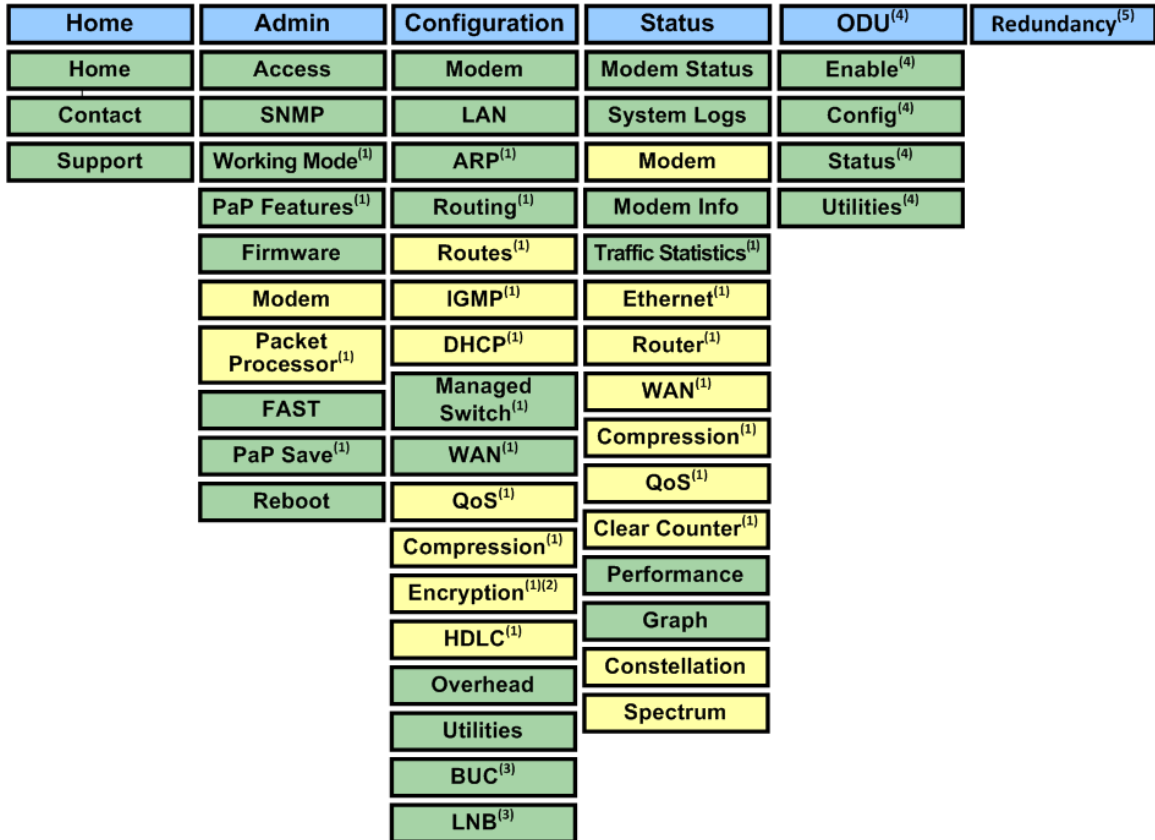

Figure 7-1. CDM-570A HTTP Interface Menu Tree

### 7.4.2.1 HTTP Interface – IMPORTANT Conditional Operating Notes



REFERRING TO Figure 7-1 – CAREFULLY REVIEW THESE HTTP INTERFACE USAGE NOTES:

- The navigation tabs and/or nested pages marked (1) in this diagram are associated with the optional High-Performance Packet Processor. They are non-functional when this optional hardware is not installed.

If you attempt to select a page requiring the presence of the optional Packet Processor, and this hardware is not installed, the following page displays:

**CDM-570A: Comtech EF Data Modem :: No Packet Processor Card**

Home Admin Configuration Status ODU Redundancy

Page not available: Packet Processor card is not installed!

[Back to previous page](#)

When the optional Packet Processor is INSTALLED, in addition to saving operational parameters on an active page associated with Packet Processor operation, unless otherwise noted you must also open the 'Admin | Pap Save' page (see Sect. 7.4.3.2.8) and immediately click [Save PaP Parameters].

- The pages marked (2) in this diagram are functional only when the FAST option is purchased and activated for operation. Some features, while listed, are future offerings and not available at this time (e.g., Encryption).

See Chapter 5. FAST ACTIVATION PROCEDURE for detailed information on managing FAST options.

- The navigation tabs and/or nested pages marked (3) in this diagram are provided for monitor and control of a Comtech EF Data BUC (Block Up Converter) or LNB (Low-Noise Block Down Converter). They are functional only when such products are connected to the CDM/R-570AL (L-Band) Satellite Modem.

Similarly, the navigation tabs and/or nested pages marked (4) are provided for monitor and control of a Comtech EF Data RF Transceiver (CSAT-5060 or KST-2000A/B). They are functional only when such products are connected to the CDM-570A (70/140 MHz) Satellite Modem.

See Chapter 10. CDM-570A/570AL ODU (TRANSCEIVER, BUC, LNB) M&C OPERATION for detailed information on managing these products over the available remote product management interfaces.

- The navigation tab and page marked (5) in this diagram is provided for monitor and control of a Comtech EF Data Redundancy Switch. This page is functional only when such products are connected to the CDM-570A/570AL in a redundant configuration:
  - 1:1 Redundancy is supported using either a CRS-170A L-Band 1:1 Redundancy Switch (when using CDM/R-570AL modems) or a CRS-180 70/140 MHz 1:1 Redundancy Switch (when using CDM-570A modems), and a user-provided, off-the-shelf Ethernet switch.
  - 1:N Redundancy is supported using a CRS-300/CRS-280L 1:10 Redundancy Switch (when using CDM/R-570AL modems) or a CRS-300/CRS-280 1:10 Redundancy Switch (when using CDM-570A modems).

Refer to the pertinent switch Installation and Operation Manual for detailed information on setting up and using the CDM-570A/570AL in redundant operations.



## 7.4.3 CDM-570A HTTP Interface Page Descriptions



Access to and availability of certain CDM-570A HTTP Interface pages is dependent upon the FAST options purchased for operation as well as the detected presence of optional or auxiliary products (e.g., the optional Packet Processor, LNBS or BUCs, Redundancy Switch, etc.) installed and configured for use with the CDM-570A/570AL. Such operational restrictions are noted through the remainder of this chapter.

---

### 7.4.3.1 Home Pages

#### 7.4.3.1.1 Home | Home

Click the **Home** tab from any location within the CDM-570A HTTP Interface to return to this top-level page.

Note that the Packet Processor Firmware information does not appear on this page when the optional Packet Processor is not installed.

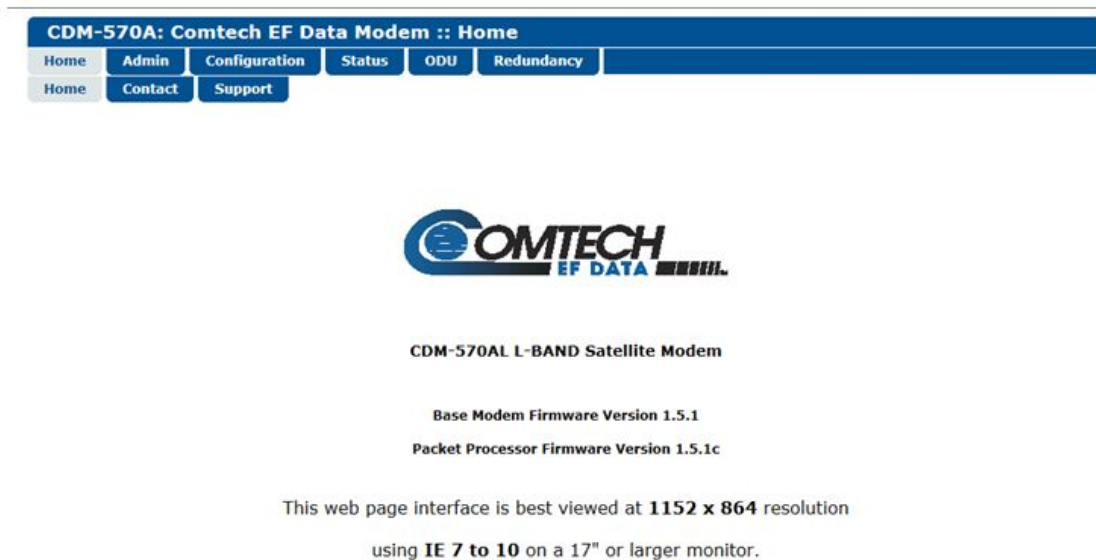

Figure 7-2. CDM-570A/570AL Satellite Modem Home Page

### 7.4.3.1.2 Home | Contact

For all product support, please contact:

#### Sales

- E-Mail: [sales@comtechedata.com](mailto:sales@comtechedata.com)
- Phone: +1.480.333-2177
- Fax: +1.480-333-2540

#### Service

- E-Mail: [esc@comtechedata.com](mailto:esc@comtechedata.com)
- Phone: +1.866.472.3963 (toll free USA)
- Fax: +1.480.333.2500

#### To Request a CD-ROM

- E-Mail: [sales @comtechedata.com](mailto:sales@comtechedata.com)
- Phone: +1.480-333-2473



VIA	Sales	Service
	<a href="mailto:sales@comtechedata.com">sales@comtechedata.com</a>	<a href="mailto:esc@comtechedata.com">esc@comtechedata.com</a>
	(480) 333-2177	1-866-472-3963
	(480) 333-2540	(480) 333-2500

For product information online, please visit our website at : [www.comtechedata.com](http://www.comtechedata.com)



#### Now available on CD-ROM:

- Product Data Sheets
- Software Demos
- Application Notes
- Manuals
- Contact information, and more

To request a CD-ROM, call (480) 333-2473 or email: [sales@comtechedata.com](mailto:sales@comtechedata.com)

**Figure 7-3. Home | Contact Page**

### 7.4.3.1.3 Home | Support

Complete the Contact Information and Problem Support, then Click [Submit] to send the information to Comtech EF Data.



**CDM-570A: Comtech EF Data Modem :: Support**

Home Admin Configuration Status ODU Redundancy

Home Contact Support

**Contact Information**

Name

Company

Telephone

E-mail

**Problem Report**

Submit Email

Figure 7-4. Home | Support Page

### 7.4.3.2 Admin Pages



1. The Admin pages are available only when you have logged in using the Administrator Name and Password.
2. Certain page tabs are available only when you install the optional Packet Processor.

The Administrator may use these pages to set up user names, passwords, the e-mail server, and the host IP Addresses as required to establish communication with the CDM-570A HTTP Interface.

Click, where available, the **Access**, **SNMP**, **Working Mode**, **PaP Features**, **Firmware**, **FAST**, **PaP Save**, or **Reboot** tab to continue.

#### 7.4.3.2.1 Admin | Access



This page is available only when you log in with the Administrator Name and Password.

**CDM-570A: Comtech EF Data Modem :: Access**

Home
Admin
Configuration
Status
ODU
Redundancy

Access
SNMP
Working Mode
PaP Features
Firmware
FAST
RADIUS
PaP Save
Reboot

**System Account Access Information**

Read Only Name <input type="text" value="monitor"/>	Read Only Password <input type="text" value="1234"/>	SMTP Server <input type="text"/>
Read/Write Name <input type="text" value="opcenter"/>	Read/Write Password <input type="text" value="1234"/>	SMTP Domain Name <input type="text"/>
Admin Name <input type="text" value="comtech"/>	Admin Password <input type="text" value="comtech"/>	SMTP Destination <input type="text" value="cdmipsupport"/>

**Host Access List**

Access List  ▼

<input type="checkbox"/> IP 1 / Mask <input type="text" value="000.000.000.000"/> / <input type="text" value="0"/>	<p><b>Be sure to include yourself!</b></p> <input type="checkbox"/> IP 2 / Mask <input type="text" value="000.000.000.000"/> / <input type="text" value="0"/>
<input type="checkbox"/> IP 3 / Mask <input type="text" value="000.000.000.000"/> / <input type="text" value="0"/>	<input type="checkbox"/> IP 4 / Mask <input type="text" value="000.000.000.000"/> / <input type="text" value="0"/>

Figure 7-5. Admin | Access Page

## System Account Access Information

- **Read-only, Read/Write, Admin Names and Passwords** – The factory defaults for these user names and passwords are as follows:

Description	Factory Default User Name / Password	Typical Parameters
<i>read-only</i>	monitor / 1234	Name and Password fields can be any alphanumeric combination with a maximum length of 10 characters.
Read/Write	opcenter / 1234	
Admin	comtech / comtech	

- **SMTP Server** – Specify the mail server IP Address from where e-mail may be sent.
- **SMTP Domain Name / Destination** – The Administrator can assign the SMTP Domain Name and Destination. This is required if the e-mail feature of the **'Home | Support'** page is to be used.
  - For **SMTP Domain Name**, specify the domain of the e-mail server (usually found to the right of the @ symbol in an e-mail address).
  - For **SMTP Domain Destination**, specify the e-mail recipient name (usually found to the left of the @ symbol in an e-mail address).

## Host Access List

- **IP (#) / Mask** – Use the Host Access List to define which remote clients can connect when the Access List is **Enabled**. Each entry allows access to a unique class of machines. Enter an IP address and a subnet mask.

**For example**, if it is desired to grant access to a PC with an IP Address of 10.10.10.1, and any PC on a subnet of 192.168.10.xxx, then the Access List would be defined as:

IP 1 / Mask: 10.10.10.1/32  
IP 2 / Mask: 192.168.10.0/24

For **IP 3 / Mask** and **IP 4 / Mask**, make sure they are not 0.0.0.0/0. An entry with 0.0.0.0/0 simply means any machine is allowed access.

- **Access List** – Use the Access List to grant access via HTTP and SNMP to a well-defined list of client machines. Use the drop-down list to select **Enable** or **Disable**. If **Disabled**, then any client machine can connect via HTTP and SNMP.

Click [**Submit Admin**] to save.

### 7.4.3.2.2 Admin | SNMP



- Chapter 6. FRONT PANEL OPERATION
- Sect. 7.3 SNMP INTERFACE

The Administrator must use this page to set and return administration information for the CDM-570A SNMP (Simple Network Management Protocol) feature.

Figure 7-6. Admin | SNMP Page

#### SNMP

- **Simple Network Management** – Use the drop-down list to select as **Disabled** or **Enabled**.
- **Enable Authentication Trap** – Use the drop-down list to select as **Disabled** or **Enabled**.
- **Trap IP 1 / Trap IP 2** – Assign up to two SNMP Trap IP Addresses.
- **Trap Version** – Use the drop-down list to select **SNMPv1** or **SNMPv2**.
- **SNMP Read/Write/Trap Community Strings, SNMP Contact/Name/Location** – Create or edit these alphanumeric text strings as follows:

Setting	Factory Default	Typical Parameters
Read Community String	public	The Read, Write, and Trap Community Strings can be any alphanumeric combination with a maximum length of 4 to 15 characters.
Write Community String	private	
Trap Community String	comtech	
SNMP Contact	N/A	The SNMP Contact, Name, and Location strings can be any alphanumeric combination with a maximum length of 0 to 20 characters.
SNMP Name	N/A	
SNMP Location	N/A	

Click **[Submit Admin]** to save.

### 7.4.3.2.3 Admin | Working Mode



1. This page is available only when you install the optional Packet Processor.
2. **WHEN YOU CHANGE WORKING MODE:** Once you click the [Submit] tab the modem undergoes forced reboot. You will need to log in to your Web session once again after the modem reboots.

Use this page to specify how the modem/Packet Processor is to function in Vipersat or non-Vipersat working modes. Once the role of a particular modem in the network is determined, this single point of configuration is intended to simplify deployment.

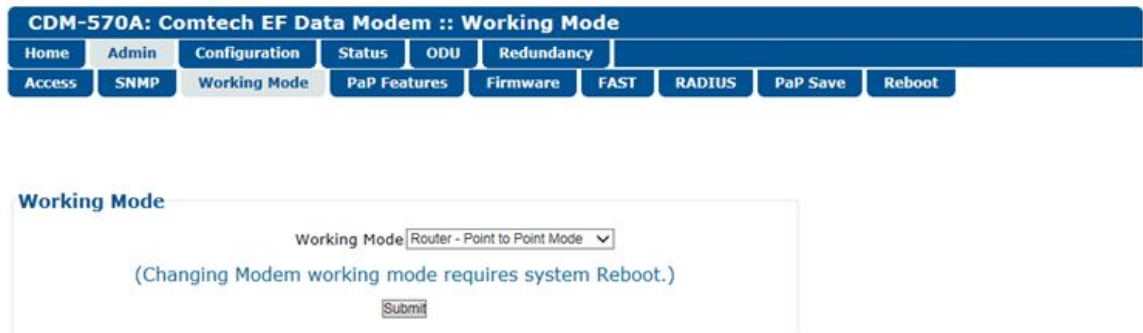

Figure 7-7. Admin | Working Mode Page

### Working Mode

Use the drop-down list to select the Working Mode:

- **Router – Small Network Mode** – This mode supports up to 253 remotes, as allowed using HDLC addressing. Select this mode to set the modem to be on independent IP subnets; this mode requires adding static routes to pass traffic between them.
- **Router – Large Network Mode** – This mode is similar to Small Network Mode, the exception being that a maximum of 32,766 remotes are allowed on a single shared satellite outbound carrier.
- **Router – Point-to-Point Mode** – This this mode is for use in a Point-to-Point SCPC link where there are different IP subnets on either side of the link.
- **Router – Vipersat Mode**



- **VMS v3.x.x VIPERSAT Management System User Guide (CEFD P/N MN/22156)**
- **Vipersat CDM-570/570L Satellite Network Modem User Guide (CEFD P/N MN/22125)**
- **Managed Switch** – This mode functions as a learning bridge with VLAN support. Optional supported features include QoS, Header Comp, Payload Comp, and 3xDES. No routes are required in this mode.

**About Managed Switch Mode:** Managed Switch Mode is Comtech’s IP modem intelligent networking solution. It is intended primarily for operation in a point-to-point topology. It allows a link to be set up with minimal configuration (no specific routes need to be configured).

When the optional Packet Processor is not installed, Managed Switch Mode provides support for Layer 2 QoS, and Dedicated Management Port or Virtual Local Area Network (VLAN).

When you install the optional Packet Processor, advanced features such as Layer 3/4/5 (Advanced) QoS, Header and Payload Compression are available. Most are accessible only under “Admin” user access.



**Sect. 7.4.3.3.5 Config | Managed Switch**

**7.4.3.2.4 Admin | PaP Features**



1. This page is available only when you install the optional Packet Processor.
2. If you submit any changes to this page, you must also open the ‘Admin | PaP Save’ page (see Sect. 7.4.3.2.8) and immediately click [Save PaP Parameters].

**Figure 7-8. Admin | PaP Features Page**

**Features – Standard**

Use the drop-down lists to set operation as **Enabled** or **Disabled**:

- Telnet
- Ping Reply
- Managed Switch Multicast Option
- LAN-to-LAN Routing
- L2 Tx Header Compression
- L2 Rx Header Compression
- Downlink Route All Available Multicast

Click [**Submit**] to save.



## Features – Optional



- Chapter 5. FAST ACTIVATION PROCEDURE
- Sect. 7.3 Admin | FAST Page



When an optional FAST feature is not available, its associated drop-down list appears dimmed and is non-selectable.

Use the drop-down lists to set operation as **Enabled** or **Disabled**:

- IGMP
- L3/L4/L5 Rx Header Compression
- Vipersat Management
- Vipersat STDMA
- Vipersat File Streamer
- Vipersat Auto Switching



- VMS v3.x.x VIPERSAT Management System User Guide (CEFD P/N MN/22156)
- Vipersat CDM-570/570L Satellite Network Modem User Guide (CEFD P/N MN/22125)

Click **[Submit]** to save.

## Features – CDM-570A

**Payload Comp Type** – At present, **ALDC** is the only payload compression type available.

**Number of System Flows** – Use the drop-down list to select **20,000** or **64,000**.

Click **[Submit]** to save.



Make sure to also click **[Save PaP Parameters]** on the 'Admin | PaP Save' page before proceeding further.

### 7.4.3.2.5 Admin | Firmware



Chapter 4. UPDATING FIRMWARE

Click the **Modem** or **Packet Processor** tab to continue.

#### 7.4.3.2.5.1 Admin | Firmware | Modem

This page displays **read-only** information sections about the base modem's Boot (Bootrom) and two operational firmware images.

CDM-570A: Comtech EF Data Modem :: Modem Firmware Information									
Home	Admin	Configuration	Status	ODU	Redundancy				
Access	SNMP	Working Mode	PaP Features	Firmware	FAST	RADIUS	PaP Save	Reboot	
Modem	Packet Processor								

**Boot**

**Image 1**

```
FW-0020683K,1.5.1 ,09/13/16
FW-0020685K,1.5.1 ,09/13/16
FW-0020686D, 1.3.1 ,07/26/16
FW-0020687C,1.3.1 ,05/09/16
FW-0020688A,1.2.1 ,05/03/16
FW-0000516-,1.1.1 ,19/01/11
FW-0021041A,1.3.1 ,06/22/16
```

**Image 2**

```
FW-0020683K,1.5.1 ,09/13/16
FW-0020685K,1.5.1 ,09/13/16
FW-0020686D, 1.3.1 ,07/26/16
FW-0020687C,1.3.1 ,05/09/16
FW-0020688A,1.2.1 ,05/03/16
FW-0000516-,1.1.1 ,19/01/11
FW-0021041A,1.3.1 ,06/22/16
```

Currently running

Next Reboot, will use

Figure 7-9. Admin | Firmware | Modem Page

### Boot

This section identifies the firmware number, version, and release date that is loaded upon power-up/boot up of the unit.

### Image 1 / Image 2

These scrollable, *read-only* windows identify the Firmware numbers, versions, and release dates that comprise the aggregate image load.

### Currently Running (*read-only*)

The current running image is identified here.

### Next Reboot, will use

Use the drop-down list to select **Image 1** or **Image 2** as the firmware image to use upon next reboot.

Click [**Submit**] to save.

### 7.4.3.2.5.2 Admin | Firmware | Packet Processor



1. This page is available only when you install the optional Packet Processor.
2. If you submit any changes to this page, you must also open the 'Admin | PaP Save' page (see Sect. 7.4.3.2.8) and immediately click [Save PaP Parameters].

This page displays *read-only* information about the optional Packet Processor's Bootrom and two operational firmware images, and allows you to select the firmware image to boot from upon modem reboot.

CDM-570A: Comtech EF Data Modem :: Packet Processor Firmware					
Home	Admin	Configuration	Status	ODU	Redundancy
Access	SNMP	Working Mode	PaP Features	Firmware	FAST
Modem	Packet Processor				

Firmware					
Bootrom	Boot	9/12/2016 15:43	FW-0020788L	1.5.1c	1048576
Image 1	IP Bulk #1	9/12/2016 15:43	FW-0020782L	1.5.1c	4443872
Image 2	IP Bulk #2	9/12/2016 15:43	FW-0020782L	1.5.1c	4443872

Software Revision:

Boot From:

Upgrade To:

Figure 7-10. Admin | Firmware | Packet Processor Page

#### Boot From

Use the drop-down list to select **Latest**, **Image 1**, or **Image 2** as the image to load upon reboot. Click [Submit] to save.



**Make sure to also click [Save PaP Parameters] on the 'Admin | PaP Save' page before proceeding further.**

### 7.4.3.2.6 Admin | FAST



- Chapter 5. FAST ACTIVATION PROCEDURE
- Chapter 6. FRONT PANEL OPERATION

The CDM-570A/570AL has a number of optional features that may be activated after the unit's purchase. FAST Access Codes are register-specific authorization codes that allow you to unlock these enhanced features. Contact Comtech EF Data Product Support to purchase the desired options and obtain your unique FAST Access Codes. You may then use this page to enter the codes and activate your purchased features.

**CDM-570A: Comtech EF Data Modem :: FAST**

Home
Admin
Configuration
Status
ODU
Redundancy

Access
SNMP
Working Mode
PaP Features
Firmware
FAST
RADIUS
PaP Save
Reboot

**FAST code**

Register 1

Register 2

**Demo Time Remaining: 30 days 0 hours 0 minutes**  
(Please reboot the modem after enabling the demo mode.)

Demo Mode Disabled

**Equipment ID**

<b>Modem model number:</b>	CDM-570AL
<b>Serial Number:</b>	100000000
<b>Data Rate:</b>	up to 10239kbps
<b>Tx Roll Off Factor data rate:</b>	up to 10239kbps
<b>CnC data rate:</b>	up to 10239kbps
<b>Tx VersaFEC data rate:</b>	up to 10239kbps
<b>ACM symbol rate:</b>	up to 3000kpsps
<b>Options - Installed</b>	<b>Options - Not Installed</b>
<div style="border: 1px solid #ccc; padding: 2px; font-family: monospace; font-size: 0.9em;">           Turbo Code Rate 0.95 Card            Carrier-in-Carrier Card            Expansion Card            Packet Processor Card            All TPC Code Rate            Reed-Solomon Codec            VersaFEC Codec            VersaFEC-2 Codec            Modulation: BPSK, (0)QPSK, 8QAM, 8-PSK,            16QAM, 8ARY, 16ARY, 32ARY         </div>	<div style="border: 1px solid #ccc; padding: 2px; font-family: monospace; font-size: 0.9em;">           Fractional Carrier-in-Carrier            BUC Power Supply         </div>

Figure 7-11. Admin | FAST Page

### FAST code

When you obtain a FAST Access Code from Comtech EF Data, **it will be for a specific option register**. Carefully enter each register-specific 20-character FAST Access Code. Click **[Submit]** in sequence when done. A message will display at the top of this section that states whether or not the codes are accepted or if the upgrade is successful.

### Demo Time Remaining: XX days XX hours XX minutes

Demo Mode allows access to **ALL** CDM-570A/570AL FAST options for up to 30 calendar days.

You may use the drop-down list to select Demo Mode as **Enabled** or **Disabled**. Click **[Submit]** to execute the selection, and then reboot the modem to activate Demo Mode. The time will decrement until the 30 days has expired.

### Equipment ID

This **read-only** section displays the operational status for a number of FAST-enabled features.

### Options – Installed

This scrollable, **read-only** list box displays the *installed and presently operational* FAST-enabled features.

## Options – Not Installed

This scrollable, **read-only** list box displays the *uninstalled* FAST-enabled features that are *available for purchase and activation* from Comtech EF Data.

### 7.4.3.2.7 Admin | Remote Authentication Dial In User Service (RADIUS)



#### Appendix I. CDM-570A/570L RADIUS CLIENT



The RADIUS operation is available only when the operating mode is set to IP, VersaFEC ACM (IP-ACM), or VersaFEC-2 ACM (V2-ACM).

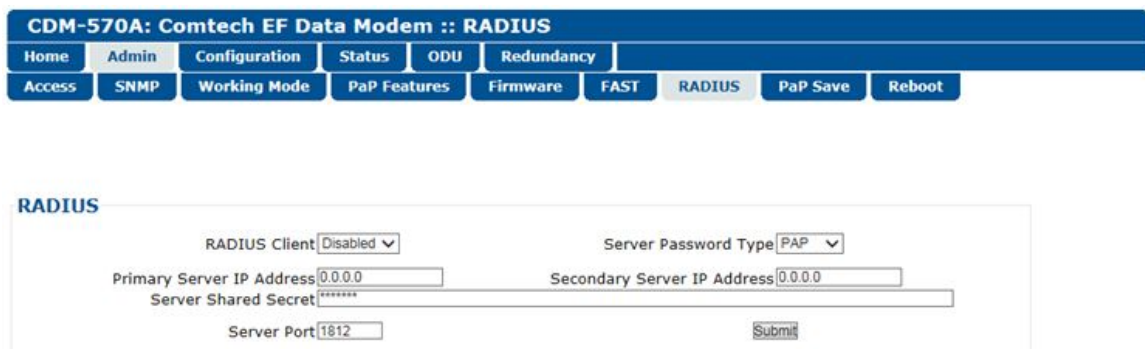

Figure 7-12. Admin | RADIUS Page

- **RADIUS Client** – Use the drop-down list to set RADIUS operation as **Enabled** or **Disabled**.
- **Server Password Type** – Use the drop-down list to select the authentication protocol as PAP (Password Authentication Protocol) or CHAP (Challenge-Handshake Authentication Protocol).
- **Primary / Secondary Server IP Address** – Enter the pertinent Server IP Addresses in the form **xxx.xxx.xxx.xxx**.
- **Server Shared Secret** – **Carefully** enter the word to be used (64 characters maximum) as the "shared secret" between the RADIUS Client Server and the networked device (CDM-570A). The interface conceals this entry for security purposes.
- **Server Port** – Enter a valid port number from **1** to **65535** (the default is **1812**).

Click **[Submit]** to save.

### 7.4.3.2.8 Admin | PaP Save



This page is available only when you install the optional Packet Processor.



**Figure 7-13. Admin | PaP Save Page**

You must click [**Save PaP Parameters**] on this page, in addition to changes made to the following CDM-570A HTTP Interface pages:

CDM-570A HTTP Interface Page	Section
Admin   PaP Features	7.4.3.2.4
Admin   Firmware   Packet Processor	7.4.3.2.5.2
Configuration   LAN (only when the optional Packet Processor is INSTALLED)	7.4.3.3.2
Configuration   ARP	7.4.3.3.3
Any nested Configuration   Routing page	7.4.3.3.4
Configuration   Managed Switch	7.4.3.3.5
Any nested Configuration   WAN page	0
Redundancy (only when the optional Packet Processor is INSTALLED)	7.4.3.6

Note that the modem reboots automatically if any changes are submitted to the '**Admin | Working Mode**' page (see **Sect. 7.4.3.2.3**).

### 7.4.3.2.9 Admin | Reboot

Use this page to perform a soft reboot of the CDM-570A/570AL using the *current, active firmware Image* as selected using the ‘Admin | Firmware | Modem’ page (Sect. 7.4.3.2.5.1).



Figure 7-14. Admin | Reboot Page

Click **[Reboot Now]** to perform the soft reboot of the CDM-570A/570AL. The page then indicates that the modem reboot is in progress:

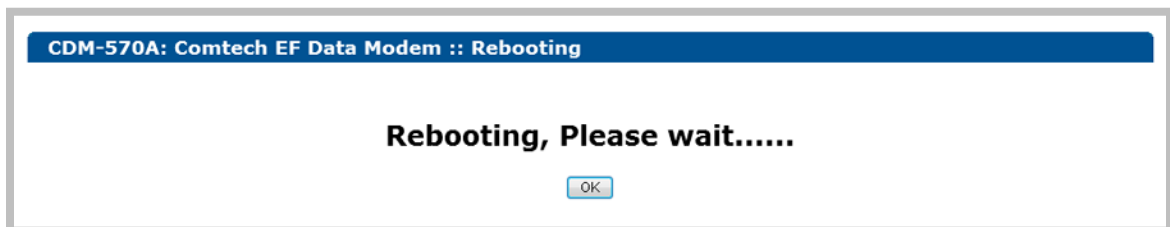

1. Click **[OK]** on the ‘Rebooting’ page to complete the reboot process. Depending on the number of installed hardware and firmware options, it may take up to one minute or more for soft reboot to execute.
2. Upon reboot, you will need to refresh your browser window. Once the Login window appears, type in your **User name** and **Password**.
3. Click **[OK]** in the Login window; the browser window will refresh to show the interface “splash” (Home) page.
4. Select any navigation tab to resume your session.

### 7.4.3.3 Configuration Pages

Use the nested 'Configuration' pages to configure all operating parameters for the CDM-570A/570AL, including the optional Packet Processor, and ODUs when connected.

Click, as applicable, the **Modem**, **LAN**, **ARP**, **Routing**, **Managed Switch**, **WAN**, **Overhead**, **Utilities**, **BUC**, or **LNB** tab to continue.

#### 7.4.3.3.1 Configuration | Modem



- Chapter 6. FRONT PANEL OPERATION
- Appendix P. ADAPTIVE CODING AND MODULATION (ACM) OPTION

**CDM-570A: Comtech EF Data Modem :: Modem Configuration**

Home
Admin
Configuration
Status
ODU
Redundancy

Modem
LAN
ARP
Routing
Managed Switch
WAN
Overhead
Utilities
BUC
LNB

**Interface / Framing**

(Submit Unit Interface Type and Framing Mode BEFORE setting other configuration parameters.)

Unit Interface Type  Unit Framing Mode

If CnC-APC is active, key transmission/reception parameters (Modulation, FEC type, Code Rate, Framing, Data Rate, Interface) cannot be modified until CnC-APC is suspended. (Go to Overhead tab to suspend or activate.)

**Transmit**

FEC Type

Modulation Type

FEC Code Rate

Data Rate  kbps (Synchronous)

Symbol Rate  kspss

Frequency  MHz

Spectrum

Scrambler

Data Invert

Clock Invert

Carrier

Tx Filter Rolloff Factor

Tx Power Level  dBm

**Receive**

FEC Type

Demodulation Type

FEC Code Rate

Data Rate  kbps (Synchronous)

Symbol Rate  kspss

Frequency  MHz

Spectrum

De-Scrambler

Acquisition Sweep Width  kHz (+/-)

Data Invert

Clock Invert

Eb/No Alarm Pt  dB

Rx Filter Rolloff Factor

**Carrier-in-Carrier (CnC)**

Mode

Search Delay Range   ms (min/max)

Freq Offset Range  kHz (+/-)

Figure 7-15. Configuration | Modem Page (Non-ACM Modes)



**CDM-570A: Comtech EF Data Modem :: Modem Configuration**

Home
Admin
Configuration
Status
ODU
Redundancy

Modem
LAN
ARP
Routing
Managed Switch
WAN
Overhead
Utilities
BUC
LNB

**Interface / Framing**

(Submit Unit Interface Type and Framing Mode BEFORE setting other configuration parameters.)

Unit Interface Type  Unit Framing Mode

If CnC-APC is active, key transmission/reception parameters (Modulation, FEC type, Code Rate, Framing, Data Rate, Interface) cannot be modified until CnC-APC is suspended. (Go to Overhead tab to suspend or activate.)

**Transmit**

FEC Type

Modulation Type

FEC Code Rate

Data Rate  kbps (Synchronous)

Symbol Rate  ksps

Frequency  MHz

Spectrum

Scrambler

Data Invert

Clock Invert

Carrier

Tx Filter Rolloff Factor

Tx Power Level  dBm

**Receive**

FEC Type

Demodulation Type

FEC Code Rate

Data Rate  kbps (Synchronous)

Symbol Rate  ksps

Frequency  MHz

Spectrum

De-Scrambler

Acquisition Sweep Width  kHz (+/-)

Data Invert

Clock Invert

SNR Alarm Pt  dB

Rx Filter Rolloff Factor

**Carrier-in-Carrier (CnC)**

Mode

Search Delay Range   ms (min/max)

Freq Offset Range  kHz (+/-)

**IP-ACM**

Minimum ModCod

Maximum ModCod

When distant-end demod loses lock

Target Eb/No Margin  dB

Figure 7-16. Configuration | Modem | IP-ACM (VersaFEC ACM) Page

**CDM-570A: Comtech EF Data Modem :: Modem Configuration**

Home
Admin
Configuration
Status
ODU
Redundancy

Modem
LAN
ARP
Routing
Managed Switch
WAN
Overhead
Utilities
BUC
LNB

**Interface / Framing**

(Submit Unit Interface Type and Framing Mode BEFORE setting other configuration parameters.)

Unit Interface Type  Unit Framing Mode

If CnC-APC is active, key transmission/reception parameters (Modulation, FEC type, Code Rate, Framing, Data Rate, Interface) cannot be modified until CnC-APC is suspended. (Go to Overhead tab to suspend or activate.)

**Transmit**

FEC Type

Modulation Type

FEC Code Rate

Data Rate  kbps (Synchronous)

Symbol Rate  ksps

Frequency  MHz

Spectrum

Scrambler

Data Invert

Clock Invert

Carrier

Tx Filter Rolloff Factor

Tx Power Level  dBm

**Receive**

FEC Type

Demodulation Type

FEC Code Rate

Data Rate  kbps (Synchronous)

Symbol Rate  ksps

Frequency  MHz

Spectrum

De-Scrambler

Acquisition Sweep Width  kHz (+/-)

Data Invert

Clock Invert

SNR Alarm Pt  dB

Rx Filter Rolloff Factor

**Carrier-in-Carrier (CnC)**

Mode

Search Delay Range   ms (min/max)

Freq Offset Range  kHz (+/-)

**VersaFEC-2 ACM**

Maximum ModCod

When distant-end demod loses lock

Target SNR Margin  dB

**Figure 7-17. Configuration | Modem | VersaFEC-2-ACM (V2-ACM) Page**

Use the 'Configuration | Modem' page to configure these modem operating parameters:

- Unit Interface and Framing Mode\*
- Tx Power Level
- Tx / Rx Operating Parameters
- Carrier-in-Carrier (CnC) Parameters
- VersaFEC ACM (IP-ACM) or VersaFEC-2 ACM (V2-ACM) Parameters



**\* Unit Interface Type and Framing Mode have higher priority and should be configured before setting other parameters.**

The page appearances change with your selection of the operating mode. Figure 7-15 shows this page as it appears when any non-ACM operating mode is active. When you select IP-ACM (VersaFEC ACM) shown in Figure 7-16, or VersaFEC2-ACM (V2-ACM) shown in Figure 7-17, the page displays the addition of the pertinent ACM section, to the right of the CnC section.

## Interface / Framing

Use the drop-down lists to select the appropriate **Unit Interface Type** and **Unit Framing Mode**.

Click **[Submit]** to save.

## Transmit

Set all Tx parameters as needed. Click **[Config Tx]** to save.



**When CDM-570 Compatible Mode is selected using the 'Configuration | Utilities' page (Sect. 7.4.3.3.8):**

1. The VersaFEC and ULL (Ultra Low Latency) Tx FEC types and their available Tx Modulation Types, Codes, and Data Rates become UNAVAILABLE. The Tx FEC Type will be reset to Viterbi and the Modulation and Code Rate will also be reset to appropriate values.
2. If the Frequency is set >2000 MHz, then it will be reset to 1201 MHz. Be sure to reconfigure your Tx IF Frequency as needed.
3. Clock Invert becomes UNAVAILABLE.
4. Tx Filter Rolloff Factor becomes FIXED at 0.35

## Receive

Set all Rx parameters as needed. Click **[Config Rx]** to save.



**When CDM-570 Compatible Mode is selected using the 'Configuration | Utilities' page (Sect. 7.4.3.3.8):**

1. The VersaFEC and ULL Rx FEC types and their available Rx Demodulation Types, Codes, and Data Rates become UNAVAILABLE. The Rx FEC Type will be reset to Viterbi and the Demodulation and Code Rate will also be reset to appropriate values.
2. If the Frequency is set >2000 MHz, then it will be reset to 1201 MHz. Be sure to reconfigure your Rx IF Frequency as needed.
3. Clock Invert becomes UNAVAILABLE.
4. Rx Filter Rolloff Factor becomes FIXED at 0.35

## Tx Power Level

Enter a Tx Power Level, in dBm, and then **[Config Power Level]** to save this setting.

## Carrier-in-Carrier (CnC)



### Appendix G. DOUBLETALK CARRIER-IN-CARRIER (CnC) OPTION



When CDM-570 Compatibility Mode is selected using the 'Configuration | Utilities' page (Sect. 7.4.3.3.8), CnC is UNAVAILABLE and this page section becomes nonfunctional.

- **Mode** – Use the drop-down list to set your desired CnC operating mode (**Off**, **Normal**, or **CnC-APC** variants).
- **Search Delay Range** – Enter minimum and maximum values, in ms.

To reduce the time taken for the CnC algorithm to converge, you may apply restrictions to the range of delay used by the search. During initial link testing, you should set the delay to a minimum of 240 ms and a maximum of 300 ms. Once CnC has found the exact delay, the value can be further reduced but care should be taken to allow sufficient range to accommodate changes in path delay due to Doppler.



**If bench-testing CnC with two units in a back-to-back configuration, you should set the minimum delay to 0 ms, and the maximum delay to 20 ms. This takes into account the lack of satellite delay.**

- **Freq Offset Range** – This range is pre-calculated. The Rx symbol rate determines the CnC Frequency Offset:
  - *From 16 to 64 ksymbols/sec (ksps):*  $\pm 1$  to the symbol rate (ksps/2)
  - *64 ksps and above:*  $\pm 1$  to 32kHz

Click **[Submit]** to save.

### 7.4.3.3.2 Configuration | LAN



If you submit any changes to this page when the optional Packet Processor is **INSTALLED**, you must also open the 'Admin | Pap Save' page (see Sect. 7.4.3.2.8) and immediately click [Save PaP Parameters].

**CDM-570A: Comtech EF Data Modem :: LAN**

Home Admin Configuration Status ODU Redundancy

Modem LAN ARP Routing Managed Switch WAN Overhead Utilities BUC LNB

---

**Network Configuration**

IP Address/Mask:  /       MAC Address:

Managed Switch Gateway IP:       Dedicated Management Port: **Disabled**

Traffic IP Address/Mask:  /       Traffic MAC Address:

Traffic IP Applicable For Dedicated Management/Redundancy Feature Only

---

**Port Configuration**

Port Traffic:       Mode & Speed:       Actual Negotiated Port Speed: **100 Mbps Full Duplex**

---

**VLAN Brouter**

VLAN Brouter Mode:       VLAN ID 1:       VLAN ID 2:

VLAN Brouter Tx Payload Compression:       VLAN ID 3:       VLAN ID 4:

VLAN Brouter Next Hop MAC Address:       VLAN ID 5:       VLAN ID 6:

VLAN Remote Mode:       VLAN ID 7:       VLAN ID 8:

VLAN Filtering:       VLAN ID 9:       VLAN ID 10:

Figure 7-18. Configuration | LAN Page

#### Network Configuration (*Typical with or without Packet Processor*)

- **IP Address/Mask** – Use this field to configure the modem’s Management IP Address.
- **Managed Switch Gateway IP** – Use this field to configure this IP Address.
- **Traffic IP Address/Mask** (*not applicable in Managed Switch Mode*) – Use this field to configure the modem’s Traffic IP Address. Note that this address is assigned automatically when the modem is running in Managed Switch Mode.
- **MAC Address** – This parameter is **read-only** and cannot be changed.
- **Dedicated Management Port** – This feature is available when the optional Packet Processor is **INSTALLED**, *but* it is unavailable when VLAN Mode is Enabled.



#### Appendix Q. DEDICATED MANAGEMENT PORT FEATURE

- **Traffic MAC Address** – This parameter is **read-only** and cannot be changed.

Click [Submit] to save.

### Port Configuration (*with optional Packet Processor INSTALLED*)

- **Port** – This column identifies the active/available IP ports.
- **Mode and Speed** – Use the drop-down list to select the speed for the active port as **Auto, 10 Mbps Half Duplex, 100 Mbps Half Duplex, 10 Mbps Full duplex, or 100 Mbps Full Duplex.**

Click [**Submit Port Cnfg**] to save.

- **Actual Negotiated Port Speed** – This column identifies the port's current operational speed and send/receive settings.

### VLAN Brouter (*with optional Packet Processor INSTALLED*)

VLAN Brouter mode operation is special mode of operation where VLAN traffic is bridged and non-VLAN traffic is routed using static route table information.

When Brouter mode is used in a hub-spoke network, the remote routers receive the whole outbound traffic transmitted by the hub. Since VLAN traffic is transmitted to the remote routers using a broadcast HDLC address, the receiver FPGA in the remote CDM-570A/570ALs will forward all the traffic to the CPU. In addition to the hub receiving traffic the remote routers shall also forward the return link (remote to hub) traffic.

- Typical for **VLAN Brouter Mode, VLAN Brouter Tx Payload Compression, VLAN Remote Mode, and VLAN Filtering** – Use the drop-down lists to **Enable** or **Disable** operation.
- **VLAN Brouter Next Hop MAC Address** – Enter the desired Next Hop IP Address for **toEth** routes. Note that no Next Hop entry is needed for **toSat** routes.
- **VLAN ID 1 through VLAN ID 10** – You may assign up to 10 VLAN ID addresses within the range from **0001** to **4095**.

Click [**Submit Changes**] to save.



**Make sure to also click [**Save PaP Parameters**] on the 'Admin | PaP Save' page before proceeding further .**

### 7.4.3.3.3 Configuration | ARP



1. This page is available only to Admin users and when you install the optional Packet Processor.
2. If you submit any changes to this page, you must also open the 'Admin | Pap Save' page (see Sect. 7.4.3.2.8) and immediately click [Save PaP Parameters].

ARP (Address Resolution Protocol) is a technique by which the HTTP Interface in Router Mode on a given network answers the ARP queries for a network address that is not on this network, but is reachable via the Packet Processor Interface.

Use this page to configure the modem's ARP parameters.

**CDM-570A: Comtech EF Data Modem :: ARP**

Home Admin Configuration Status ODU Redundancy

Modem LAN **ARP** Routing Managed Switch WAN Overhead Utilities BUC LNB

**ARP Table (Edit)**

Index	IP	MAC	Type
1	192.168.1.100	00:0e:0c:bc:22:0a	Dynamic

**Add Static ARP**

Index  IP  MAC

**Delete Static ARP**

Enter Entry Index to Delete:

**Flush Dynamic ARP**

Warning! Click on this will flush all Dynamic ARP entries

Figure 7-19. Configuration | ARP Page

#### ARP Table (Edit)

This section displays the current Static and Dynamic ARP entries and, when more than one ARP entry exists, allows you to directly edit the current Static ARP entries:

Column	Description
Index	This is the internal table index that is automatically assigned and cannot be edited.
IP	IP Address, in the format XXX.XXX.XXX.XXX.
MAC	MAC Address, in the format YY:YY:YY:YY:YY:YY.
Type	This column identifies the ARP Type as <b>Static</b> or <b>Dynamic</b> . It cannot be edited.

Click **[Submit Changes]** to save.

## Add Static ARP

This section allows you to directly add a static ARP entry. Note that the index number will automatically increment to the next available number.

Click **[Add Entry]** to save.

## Delete Static ARP

Enter **Entry Index to Delete**, and then click **[Delete Entry]**. The entry will then be deleted from the ARP table.

## Flush Dynamic ARPs

Click **[Flush ARP Table]** to delete all dynamically learned ARP entries.



Make sure to also click **[Save PaP Parameters]** on the 'Admin | PaP Save' page before proceeding further.

### 7.4.3.3.4 Configuration | Routing Pages



1. These pages are available only to Admin users and when you install the optional Packet Processor.
2. If you submit any changes to these pages, you must also open the 'Admin | Pap Save' page (see Sect. 7.4.3.2.8) and immediately click **[Save PaP Parameters]**.

Click the **Routes**, **IGMP**, or **DHCP** tab to continue.

#### 7.4.3.3.4.1 Configuration | Routing | Routes

Use this page to enter static routes into the Packet Processor to route IP traffic over the satellite or to another device on the local LAN.



**CDM-570A: Comtech EF Data Modem :: Routes**

Home Admin Configuration Status ODU Redundancy

Modem LAN ARP Routing Managed Switch WAN Overhead Utilities BUC LNB

Routes IGMP DHCP

**Route Table (Edit)**

Index	Name	Dest. IP/Mask	Interf.	Next Hop IP	Next Hop HDLC	Multicast Options	Header Comp.	Payload Comp.	Encryption	Encryption Key
1	DFG	0.0.0.0 / 0	toSat	0.0.0.0	0	noRouting	Disable	Disable	Disable	Clear Key

[Submit Changes](#)

**Add New Route**

Index	Name	Dest. IP/Mask	Interf.	Next Hop IP	Next Hop HDLC	Multicast Options	Header Comp.	Payload Comp.	Encryption	Encryption Key
2		/	toEth		0	noRouting	Disable	Disable	Disable	Key 1

[Add Entry](#)

**Delete Route**

Enter Route Index to Delete

[Delete Entry](#)

**Figure 7-20. Configuration | Routing | Routes Page**

### Route Table (Edit)

This section displays and allows you to edit all current Route Table entries. From left to right:

Column	Description
Index	This is the internal table index that is automatically assigned and cannot be edited.
Name	This label helps to maintain the network. Enter a label string in this text box. The assigned name must be unique and cannot contain any whitespace.
Dest.IP/Mask	Enter a Destination IP Address/Mask in the form XXX.XXX.XXX.XXX/YY.
Interf.	Use the drop-down list to select the Interface as <b>toEth</b> or <b>toSat</b> .
Next Hop IP	Enter the desired Next Hop IP Address for <b>toEth</b> routes. Note that no Next Hop entry is needed for <b>toSat</b> routes.
Next Hop HDLC	Displays the desired Next Hop HDLC IP Address for traffic to be sent over the satellite, within the following ranges: <ul style="list-style-type: none"> <li>Point-to-Point: No HDLC address</li> <li>Small Network: 0x1 – 0xFE</li> <li>Large Network: 0x1 – 0x7FFE</li> </ul>
Multicast Options	Use the drop-down list to select the Multicast Option as <b>noRouting</b> , <b>ethToSatRouting</b> , <b>satToEthRouting</b> , or <b>satToEthAndEthToSatRouting</b> .
Header Comp.	When the optional Header Compression FAST feature is available, use the drop-down list to <b>Disable</b> or <b>Enable</b> operations.
Payload Comp.	When the optional Payload Compression FAST feature is available, use the drop-down list to <b>Disable</b> or <b>Enable</b> operations.

Column	Description
Encryption	 <b>3xDES Encryption is a future offering and is not available in this firmware release.</b>
Encryption Key	

Click **[Submit Changes]** to save.

### Add New Route

This section allows you to directly add a route entry using text boxes and drop-down lists as described previously for the **Route Table (Edit)** section.

Click **[Add Entry]** to save. Note that, when you add a new route, the index number will automatically increment to the next available number.

### Delete Route

**Enter Route Index to Delete**, and then click **[Delete Entry]**. The specified route entry will then be deleted from the route table.

 **Make sure to also click [Save PaP Parameters] on the 'Admin | PaP Save' page before proceeding further.**

## 7.4.3.3.4.2 Configuration | Routing | IGMP

This page permits use of Internet Group Management Protocol (IGMP) with configured multicast routes.

IGMP, when enabled, responds to IGMP queries for the configured multicast routes on the transmit side and generates IGMP queries on the receive side. If there are no active IGMP receivers on the LAN, it will stop forwarding the multicast traffic (received from the satellite) to the LAN.

Figure 7-21. Configuration | Routing | IGMP Page

## CDM-570A as Client

- **Recognize IGMP Queries** – Use the drop-down list to select **No** or **Yes**.
- **IGMP Version for Unsolicited Reports** – Use the drop-down list to select **V1** or **V2**.
- **Unsolicited Report Interval** – This is the maximum response time inserted into group-specific queries that are set in response to Leave Group messages, and it is also the amount of time between group-specific query messages. This value may be tuned to modify the "leave latency" of the network; a reduced value results in reduced time to detect the loss of the last member of a group.

Enter a value, in seconds, from **1** to **25** (default = 1 second).

- **Force Router Alert Option Sending V1 Reports** – Use the drop-down list to select **No** or **Yes**.

## CDM-570A as Server

- **Enable IGMP** – Use the drop-down list to select **No** or **Yes**.
- **IGMP Version for Unsolicited Reports** – Use the drop-down list to select **V1** or **V2**.
- **IGMP Query Period** – This is the interval between general queries sent by the modem. By varying the query interval, a modem administrator may tune the number of IGMP messages on the subnet; note that larger numbers cause the IGMP queries to be sent less often.

Enter a value, in seconds, from **1** to **600**.

- **IGMP Maximum Response Time** – This is the maximum response time inserted into the periodic general queries. By varying the Query Response Interval, a modem administrator may tune the "burstiness" of IGMP messages on the subnet; note that larger values make the traffic less "bursty" as host responses are spread out over a large interval.

Enter a value, in seconds, from **1** to **30**.



**The number of seconds assigned to the Query Response Interval must be less than the Query Interval.**

Click [**Submit**] to save.

## IGMP Table

This *read-only* table displays the Multicast Routes that are active on the modem.

Click [**Refresh**] to update this section with its latest available information.



**Make sure to also click [**Save PaP Parameters**] on the 'Admin | PaP Save' page before proceeding further.**

### 7.4.3.3.4.3 Configuration | Routing | DHCP

Use this page to set up the DHCP (Dynamic Host Configuration Protocol) Relay feature.

DHCP allows a device to be configured automatically – eliminating the need for intervention by a network administrator – and provides a server located at the hub for keeping track of devices that are connected to the network. This prevents two devices from accidentally being configured with the same IP Address.

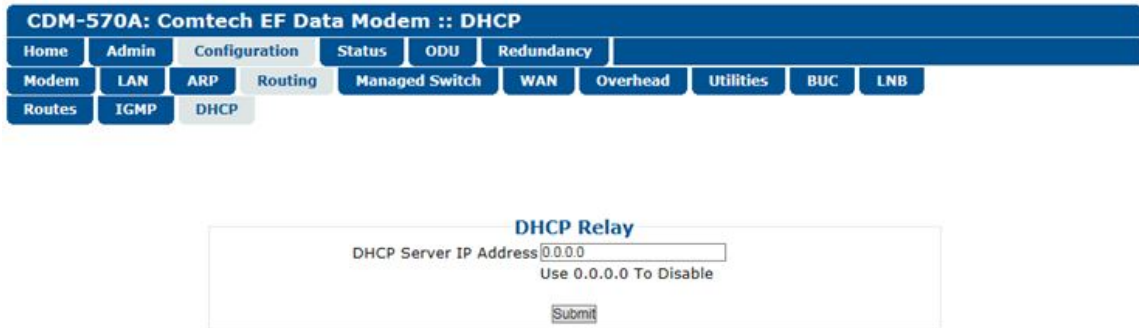

Figure 7-22. Configuration | Routing | DHCP Page

#### DHCP Relay

- **DHCP Server IP Address** – Enter the IP Address to be used for the DHCP server at the hub in the form XXX.XXX.XXX.XXX. Enter 0.0.0.0 to **disable** this feature.

Click **[Submit]** to save.



**Make sure to also click [Save PaP Parameters] on the 'Admin | PaP Save' page before proceeding further.**

### 7.4.3.3.5 Configuration | Managed Switch



1. This page is available only to Admin users and when you install the optional Packet Processor.
2. If you submit any changes to this page, you must also open the 'Admin | PaP Save' page (see Sect. 7.4.3.2.8) and immediately click [Save PaP Parameters].

Managed Switch Mode is primarily intended for operation in a point-to-point topology. It supports VLAN as well as advanced features such as QoS, Header Compression, and Payload Compression.

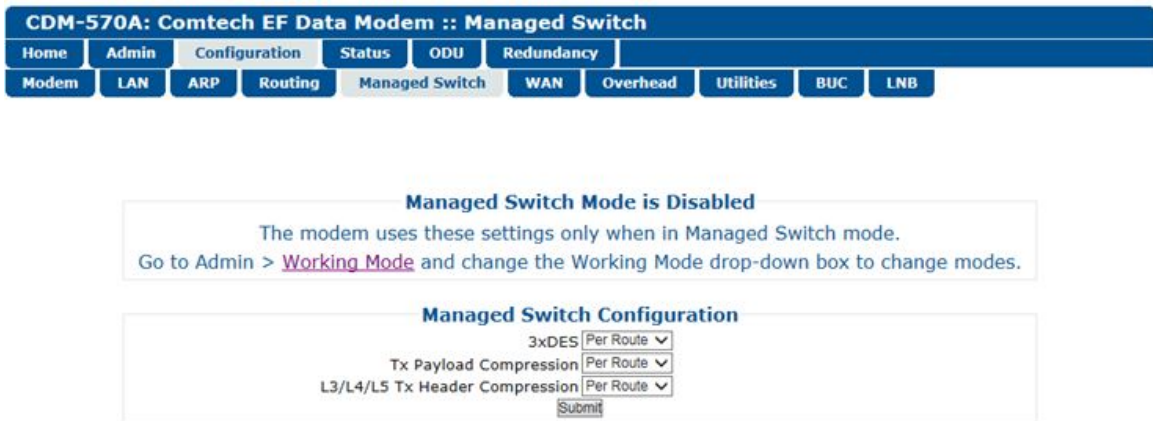

Figure 7-23. Configuration | Managed Switch Page

#### Managed Switch Configuration

- **Tx Payload Compression, or L3/L4/L5 Tx Header Compression** – When these features are available, use the drop-down lists to select operation as **Disabled**, **Enabled**, or **Per Route**.



**3xDES Encryption is a future offering and is not available in this firmware release. This drop-down list is therefore non-functional at this time.**

Click [Submit] to save.



**Make sure to also click [Save PaP Parameters] on the 'Admin | PaP Save' page before proceeding further.**

### 7.4.3.3.6 Configuration | WAN Pages



1. These nested pages are available only to Admin users and when you install the optional Packet Processor.
2. 3xDES Encryption is a future offering and is not available in this firmware release. The nested Encryption page, while selectable and viewable, is therefore non-functional at this time.
3. If you submit any changes to these pages, you must also open the 'Admin | Pap Save' page (see Sect. 7.4.3.2.8) and immediately click [Save PaP Parameters].

Click the **QoS**, **Compression**, or **HDLC** tab to continue.

### 7.4.3.3.6.1 Configuration | WAN | QoS Pages



Appendix N. QUALITY of SERVICE (QoS)



The appearance of this page, and its availability of features, is dependent on the selected QoS Mode.

**CDM-570A: Comtech EF Data Modem :: QoS**

Home Admin Configuration Status ODU Redundancy

Modem LAN ARP Routing Managed Switch WAN Overhead Utilities BUC LNB

QoS Compression Encryption HDLC

**QoS Configuration**

QoS Feature:

QoS Mode:

QoS Typical System Latency:  msec (200 - 5000)

WAN Segmentation and Reassembly (SAR) Feature:

**QoS Configuration**

QoS Feature:

QoS Mode:

QoS Typical System Latency:  msec (200 - 5000)

WAN Segmentation and Reassembly (SAR) Feature:

**QoS Max/Priority Rules Table**

Index	Protocol	Src IP Addr	Src IP Mask	Dst IP Addr	Dst IP Mask	Min Src Port	Max Src Port	Min Dst Port	Max Dst Port	Max Bw (Kbps)	Priority	WRED	Filtering
1	All	0.0.0.0	0	0.0.0.0	0	0	65535	0	65535	99999	9	Disable	Disable

**Add New QoS Rule**

Protocol	Src IP Addr	Src IP Mask	Dst IP Addr	Dst IP Mask	Min Src Port	Max Src Port	Min Dst Port	Max Dst Port	Max Bw (Kbps)	Priority	WRED	Filtering
UDP	0.0.0.0	0	0.0.0.0	0	0	65535	0	65535	99999	1(Highest)	Disable	Disable

**Delete Rule**

Enter Rule Index to Delete:

(TOP) QoS Feature = Disable  
(BOTTOM) QoS Control Mode = Rule – Max/Priority Mode (Banner, Menu Bar not shown)

Figure 7-24. Configuration | WAN | QoS Pages

**QoS Configuration**  
 QoS Feature:   
 QoS Mode:   
 QoS Typical System Latency:  msec (200 - 5000)  
 WAN Segmentation and Reassembly (SAR) Feature:

**QoS Min/Max Rules Table**

Index	Protocol	Src IP Addr	Src IP Mask	Dst IP Addr	Dst IP Mask	Min Src Port	Max Src Port	Min Dst Port	Max Dst Port	Min Bw (Kbps)	Max Bw (Kbps)	WRED Filtering	WRED Filtering
1	All	0.0.0.0	0	0.0.0.0	0	0	65535	0	65535	0	99999	Disable	Disable

**Add New QoS Rule**

Protocol	Src IP Addr	Src IP Mask	Dst IP Addr	Dst IP Mask	Min Src Port	Max Src Port	Min Dst Port	Max Dst Port	Min Bw (Kbps)	Max Bw (Kbps)	WRED Filtering	WRED Filtering
<input type="text" value="UDP"/>	<input type="text" value="0.0.0.0"/>	<input type="text" value="0"/>	<input type="text" value="0.0.0.0"/>	<input type="text" value="0"/>	<input type="text" value="0"/>	<input type="text" value="65535"/>	<input type="text" value="0"/>	<input type="text" value="65535"/>	<input type="text" value="0"/>	<input type="text" value="99999"/>	<input type="text" value="Disable"/>	<input type="text" value="Disable"/>

**Delete Rule**

Enter Rule Index to Delete:

**QoS Configuration**  
 QoS Feature:   
 QoS Mode:   
 QoS Typical System Latency:  msec (200 - 5000)  
 WAN Segmentation and Reassembly (SAR) Feature:

**QoS DiffServ Rules Table**

Index	Class	DSCP	Min Bw (kbps)	Max Bw (kbps)	Max Bw (%)	Priority
1	EXFD	46	0	99999	0	3
2	CLS1	8	0	99999	0	7
3	CLS2	16	0	99999	0	6
4	CLS3	24	0	99999	0	5
5	CLS4	32	0	99999	0	4
6	CLS5	40	0	99999	0	3
7	CLS6	48	0	99999	0	2
8	CLS7	56	0	99999	0	1
9	ASF1	1	0	99999	100	7
10	ASF2	2	0	99999	100	7
11	ASF3	3	0	99999	100	7
12	ASF4	4	0	99999	100	7

**Modify Rules**

Index	Min Bandwidth (kbps)	Max Bandwidth (kbps)	Max Percentage (%)
<input type="text" value="9"/>	<input type="text"/>	<input type="text" value="(max=99999)"/>	<input type="text" value="(0-100)"/>

**DiffServ Modes**

Precedence Based Priority:       ASF Max Bandwidth:

(TOP) QoS Control Mode = Rule – Min/Max Mode (Banner, Menu Bar not shown)  
 (BOTTOM) QoS Control Mode = DiffServ Mode (Banner, Menu Bar not shown)

Figure 7-25. Configuration | WAN | QoS Pages (cont.)



**QoS Configuration**  
 QoS Feature:  ▼  
 QoS Mode:  ▼  
 QoS Typical System Latency:  msec (200 - 5000)  
 WAN Segmentation and Reassembly (SAR) Feature:  ▼

**QoS: VLAN - Priority/Max Rules Table**

Index	VLAN Priority	MaxBW	WRED	
1	7	<input type="text" value="99999"/>	No <span style="font-size: small;">▼</span>	<input type="button" value="Submit Changes"/>
2	6	<input type="text" value="99999"/>	No <span style="font-size: small;">▼</span>	<input type="button" value="Submit Changes"/>
3	5	<input type="text" value="99999"/>	No <span style="font-size: small;">▼</span>	<input type="button" value="Submit Changes"/>
4	4	<input type="text" value="99999"/>	No <span style="font-size: small;">▼</span>	<input type="button" value="Submit Changes"/>
5	3	<input type="text" value="99999"/>	No <span style="font-size: small;">▼</span>	<input type="button" value="Submit Changes"/>
6	2	<input type="text" value="99999"/>	No <span style="font-size: small;">▼</span>	<input type="button" value="Submit Changes"/>
7	1	<input type="text" value="99999"/>	No <span style="font-size: small;">▼</span>	<input type="button" value="Submit Changes"/>
8	0	<input type="text" value="99999"/>	No <span style="font-size: small;">▼</span>	<input type="button" value="Submit Changes"/>

QoS Control Mode = VLAN – Priority/Max Mode (Banner, Menu Bar not shown)

Figure 7-26. Configuration | WAN | QoS Pages (cont.)

### QoS Configuration



This page section’s appearance and function is typical for all selected QoS Modes.

- **QoS Feature** – Use the drop-down list to **Enable** or **Disable** QoS operation.



**Be sure to click [Submit] once you Enable operation; otherwise, all other operations on this page will be inaccessible.**

- **QoS Mode** – Use the drop-down list to set the QoS Mode as **Rule – Max/Priority Mode**, **Rule – Min/Max Mode**, **DiffServ Mode**, or **VLAN – Priority/Max Mode**.
- **QoS Typical System Latency** – Enter a value, in milliseconds, from **200** to **5000**.

**WAN Segmentation and Reassembly (SAR)** – Use the drop-down list to **Disable** or **Enable** WAN SAR operation.

WAN SAR is an adaptive process that triggers only when the packet latency exceeds 25 msec.

WAN SAR is needed, when running small-speed (i.e., <700 kbps) links, to keep latency and jitter within the 25 msec latency/10 msec jitter specification high priority queue when the lower priority queue contains large packets.

Click **[Submit]** to save.



The information that follows is applicable only when QoS Mode = Rule – Max/Priority Mode

## QoS Max/Priority Rules Table

Index	Protocol	Src IP Addr	Src IP Mask	Dst IP Addr	Dst IP Mask	Min Src Port	Max Src Port	Min Dst Port	Max Dst Port	Max Bw (Kbps)	Priority	WRED	Filtering
1	All	0.0.0.0	0	0.0.0.0	0	0	65535	0	65535	99999	9	Disable	Disable

This section displays all *existing* QoS Max/Priority Rules Table entries. From left to right:

Column	Description
Index	This is the internal table index that is automatically assigned and cannot be edited.
Protocol	Specifies the protocol for the specific rule.
Src IP Addr	Identifies the Source IP Address in the form XXX.XXX.XXX.XXX.
Src IP Mask	Identifies the Source IP Mask in the form YY.
Src IP Addr	Identifies the Destination IP Address in the form XXX.XXX.XXX.XXX.
Dest IP Mask	Identifies the Destination IP Mask in the form YY.
Min Src Port	Specifies the Minimum Source Port.
Max Src Port	Specifies the Maximum Source Port.
Min Dst Port	Specifies the Minimum Destination Port.
Max Dst Port	Specifies the Maximum Destination Port.
Max BW (Kbps)	Specifies the Maximum Bandwidth value in kilobits per second.
Priority	Specifies the priority established for the specific rule (1-8).
WRED	Specifies the WRED (Weighted Random Early Detection) setting for the specific rule as Disable or Enable.
Filtering	Specifies the flow filter setting for the specific rule as Disable or Enable.

## Add New Max/Priority QoS Rule

**Add New QoS Rule**

Protocol	Src IP Addr	Src IP Mask	Dst IP Addr	Dst IP Mask	Min Src Port	Max Src Port	Min Dst Port	Max Dst Port	Max Bw (Kbps)	Priority	WRED	Filtering
UDP	0.0.0.0	0	0.0.0.0	0	0	65535	0	65535	99999	1(Highest)	Disable	Disable

This section allows you to directly **add** a *new* Max/Priority QoS Rule.

- **Protocol / Priority / WRED / Filtering** – Use the drop-down list to select the desired operation.
- **Src IP Mask / Dst IP Addr and Mask / Min and Max Src Port / Min and Max Dst Port / Max BW (Kbps)** – Entire the desired value parameter as needed.

Click **[Add Rule]** to save. When you add a new rule to the QoS Max/Priority Rules Table, the modem automatically assigns an internal table index number to the table.

## QoS Max/Priority Delete Rule

**Delete Rule**

Enter Rule Index to Delete

[Delete Rule](#)

Enter **Rule Index to Delete**, and then click **[Delete Rule]** to execute removal of the specified rule from the QoS Max/Priority Rules Table.



**The information that follows is applicable only when QoS Mode = Rule – Min/Max Mode**

## QoS Min/Max Rules Table

Index	Protocol	Src IP Addr	Src IP Mask	Dst IP Addr	Dst IP Mask	Min Src Port	Max Src Port	Min Dst Port	Max Dst Port	Min Bw (Kbps)	Max Bw (Kbps)	WRED	Filtering
1	All	0.0.0.0	0	0.0.0.0	0	0	65535	0	65535	0	99999	Disable	Disable

This section displays all *existing* QoS Min/Max Rules Table entries. From left to right:

Column	Description
Index	This is the internal table index that is automatically assigned and cannot be edited.
Protocol	Specifies the protocol for the specific rule.
Src IP Addr	Identifies the Source IP Address in the form XXX.XXX.XXX.XXX.
Src IP Mask	Identifies the Source IP Mask in the form YY.
Src IP Addr	Identifies the Destination IP Address in the form XXX.XXX.XXX.XXX.
Dest IP Mask	Identifies the Destination IP Mask in the form YY.
Min Src Port	Specifies the Minimum Source Port.
Max Src Port	Specifies the Maximum Source Port.
Min Dst Port	Specifies the Minimum Destination Port.
Max Dst Port	Specifies the Maximum Destination Port.
Min BW (Kbps)	Specifies the Minimum Bandwidth value in kilobits per second.
Max BW (Kbps)	Specifies the Maximum Bandwidth value in kilobits per second.
WRED	Specifies the <b>WRED</b> (Weighted Random Early Detection) setting for the specific rule as <b>Disable</b> or <b>Enable</b> .
Filtering	Specifies the flow filter setting for the specific rule as <b>Disable</b> or <b>Enable</b> .

## Add New **Min/Max** QoS Rule

**Add New QoS Rule**

Protocol	Src IP Addr	Src IP Mask	Dst IP Addr	Dst IP Mask	Min Src Port	Max Src Port	Min Dst Port	Max Dst Port	Min Bw (Kbps)	Max Bw (Kbps)	WRED	Filtering
UDP	0.0.0.0	0	0.0.0.0	0	0	65535	0	65535	0	99999	Disable	Disable
<input type="button" value="Add Rule"/>												

This section allows you to directly **add** a *new* Min/Max QoS Rule:

- **Protocol / Priority / WRED / Filtering** – Use the drop-down list to select the desired operational state.
- **Src IP Mask / Dst IP Addr and Mask / Min and Max Src Port / Min and Max Dst Port / Max BW (Kbps)** – Entire the desired parameter as needed.

Click **[Add Rule]** to save. When you add a new rule to the QoS Max/Priority Rules Table, the modem automatically assigns an internal table index number.

## QoS Min/Max Delete Rule

**Delete Rule**

Enter Rule Index to Delete

**Enter Rule Index to Delete**, and then click **[Delete Rule]** to execute removal of the specified rule from the QoS Min/Max Rules Table.



**The information that follows is applicable only when QoS Mode = DiffServ Mode**

## QoS DiffServ Rules Table

QoS DiffServ Rules Table						
Index	Class	DSCP	Min Bw (kbps)	Max Bw (kbps)	Max Bw (%)	Priority
1	EXFD	46	0	99999	0	3
2	CLS1	8	0	99999	0	7
3	CLS2	16	0	99999	0	6
4	CLS3	24	0	99999	0	5
5	CLS4	32	0	99999	0	4
6	CLS5	40	0	99999	0	3
7	CLS6	48	0	99999	0	2
8	CLS7	56	0	99999	0	1
9	ASF1	1	0	99999	100	7
10	ASF2	2	0	99999	100	7
11	ASF3	3	0	99999	100	7
12	ASF4	4	0	99999	100	7

This section displays all *existing* QoS DiffServ (Differentiated Services) Rules Table entries. From left to right:

Column	Description
Index	This is the internal table index that is automatically assigned and cannot be edited.
Class	Specifies the DSCP Class Selector Precedence type (Expedited Forwarding, Assured Forwarding, etc.)
DSCP	Specifies the Class Selector DiffServ Code Point (DSCP) value in the Type of Service (ToS) byte within the IP header .
Min Bw (kbps)	Specifies the Minimum Bandwidth value in kilobits per second.
Max Bw (kpbs)	Specifies the Maximum Bandwidth value in kilobits per second.
Max Bw (%)	Specifies the Maximum Bandwidth (%) value. This is useful where the uppermost bandwidth limit must be scaled as a percentage of the Tx bandwidth of the modem, when the modem bandwidth changes over time due to ACM or DSCPC in Vipersat Mode
Priority	Specifies the priority established for the specific rule (1-8).

## QoS DiffServ Modify Rules

**Modify Rules**

<b>Index</b> <input type="text" value="9"/>	<b>Min Bandwidth (kbps)</b> <input type="text"/>	<b>Max Bandwidth (kbps)</b> <input type="text"/> (max=99999)	<b>Max Percentage (%)</b> <input type="text"/> (0-100)
<input type="button" value="Modify Rule"/>			

This section allows you to modify an existing DiffServ QoS Rule:

- **Index** – Use the drop-down list to select the rule to modify.
- **Min Bandwidth (kpbs) / Max Bandwidth (kbps) / Max Percentage (%)** – Entire the desired parameter as needed.

Click **[Modify Rule]** to update the existing rule.

## QoS DiffServ Modes

**DiffServ Modes**

Precedence Based Priority       ASF Max Bandwidth

- **Precedence Based on Priority** – Use the drop-down list to **Disable** or **Enable** the Packet Processor’s prioritization of traffic based upon the DSCP Class Selector Precedence.
- **ASF Max Bandwidth** – Applicable to Assured Forwarding, this defines the value that is used to restrict the maximum bandwidth that any particular flow will utilize. Use the drop-down list to select **Datarate** or **Percentage**.

Click **[Submit]** to save.



The information that follows is applicable only when QoS Mode = VLAN – Priority/Max Mode

## QoS: VLAN – Priority/Max Rules Table

QoS: VLAN - Priority/Max Rules Table				
Index	VLAN Priority	MaxBW	WRED	
<b>1</b>	7	<input type="text" value="99999"/>	<input type="text" value="No"/>	<input type="button" value="Submit Changes"/>
<b>2</b>	6	<input type="text" value="99999"/>	<input type="text" value="No"/>	<input type="button" value="Submit Changes"/>
<b>3</b>	5	<input type="text" value="99999"/>	<input type="text" value="No"/>	<input type="button" value="Submit Changes"/>
<b>4</b>	4	<input type="text" value="99999"/>	<input type="text" value="No"/>	<input type="button" value="Submit Changes"/>
<b>5</b>	3	<input type="text" value="99999"/>	<input type="text" value="No"/>	<input type="button" value="Submit Changes"/>
<b>6</b>	2	<input type="text" value="99999"/>	<input type="text" value="No"/>	<input type="button" value="Submit Changes"/>
<b>7</b>	1	<input type="text" value="99999"/>	<input type="text" value="No"/>	<input type="button" value="Submit Changes"/>
<b>8</b>	0	<input type="text" value="99999"/>	<input type="text" value="No"/>	<input type="button" value="Submit Changes"/>

This section displays and permits you to modify all *existing* QoS VLAN – Priority/Max Rules Table entries. From left to right:

Column	Description
Index	This is the internal table index that is automatically assigned and cannot be edited.
VLAN Priority	Specifies the VLAN Priority established for the specific rule (0-7).
Max Bw (kpbs)	Specifies the Maximum Bandwidth value in kilobits per second.
WRED	Specifies the <b>WRED</b> (Weighted Random Early Detection) setting for the specific rule as Yes or No.

Click **[Submit Changes]** to update the specified rule.



**Make sure to also click [Save PaP Parameters] on the ‘Admin | PaP Save’ page before proceeding further.**

### 7.4.3.3.6.2 Configuration | WAN | Compression

Use this page to configure the optional Payload and Header Compression, when this FAST feature is enabled.

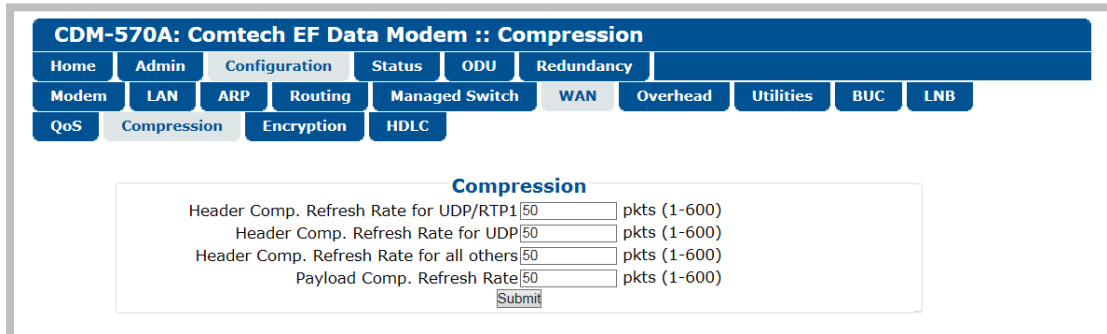

Figure 7-27. Configuration | WAN | Compression Page

#### Compression

- **Header Comp. Refresh Rate for UDP/RTP1** – Enter the number of packets, from **1** to **600**, required to trigger the Header Compression’s User Datagram Protocol/Real Time Protocol refresh rate.
- **Header Comp. Refresh Rate for UDP** – Enter the number of packets, from **1** to **600**, required to trigger the Header Compression’s User Datagram Protocol refresh rate.
- **Header Comp. Refresh Rate for all others** – Enter the number of packets, from **1** to **600**, required to trigger the Header Compression’s Default Protocol refresh rate.
- **Payload Comp. Refresh Rate** – Enter the number of packets, from **1** to **600**, required to trigger the Payload Compression’s refresh rate.

Click **[Submit]** to save.



**Make sure to also click [Save PaP Parameters] on the ‘Admin | PaP Save’ page before proceeding further.**

### 7.4.3.3.6.3 Configuration | WAN | HDLC

This page allows configuration of HDLC encapsulation parameters.

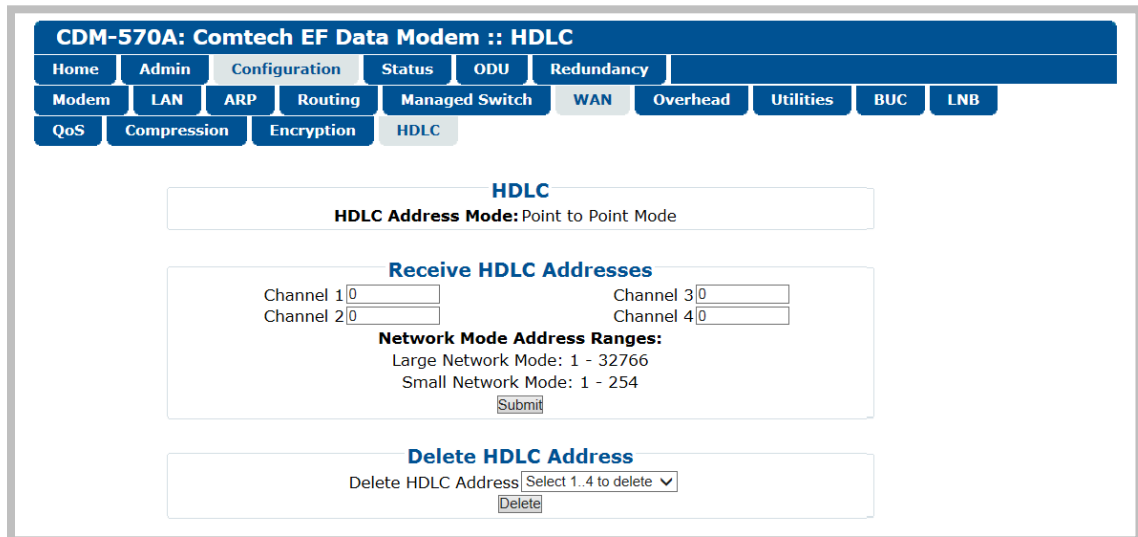

Figure 7-28. Configuration | WAN | HDLC Page

#### HDLC

Identifies the HDLC Address Mode that was defined using the ‘Admin | Working Mode’ page (Sect. 7.4.3.2.3): **Small Network Mode, Large Network Mode, Point-to-Point Mode, Vipersat Mode, or Managed Switch mode.**

#### Receive HDLC Addresses

Enter the Network Mode Address Range for Channels 1 through 4 here. Note that the valid Small Network Mode address range is from 1 to 254, and the Large Network Mode address range is from 1 to 32766.

Click **[Submit]** to save.

#### Delete HDLC Address

Use the drop-down list to delete an HDLC Address on a per-channel basis (**1, 2, 3, or 4**); otherwise, choose “**Select 1...4 to delete**” to delete all assigned addresses.

Click **[Delete]** to execute your choice.



**Make sure to also click [Save PaP Parameters] on the ‘Admin | PaP Save’ page before proceeding further.**



### 7.4.3.3.7 Configuration | Overhead



#### Chapter 6. FRONT PANEL OPERATION

**CDM-570A: Comtech EF Data Modem :: Overhead**

Home	Admin	Configuration	Status	ODU	Redundancy					
Modem	LAN	ARP	Routing	Managed Switch	WAN	Overhead	Utilities	BUC	LNB	

**AUPC**

AUPC: Disabled ▾

Rem Demod Target Eb/No: 03.0 dB (0.0 - 14.9)

TX Power Max Increase: 3 dB ▾

Max Pwr Reached Action: No Action ▾

Rem Demod Unlock Action: Go to Nominal Power ▾

**EDMAC**

EDMAC Framing Mode: EDMAC OFF ▾

EDMAC Slave Address: 0020

**CnC-APC**

Tx Max Power Increase: 2.5 dB (0.0-9.9)

**APC is not active**

BER: 9999

FER: 9999

If CnC-APC is active, key transmission/reception parameters (Modulation, FEC type, Code Rate, Framing, Data Rate, Interface) cannot be modified until CnC-APC is suspended.

**EDMAC**

EDMAC Framing Mode: EDMAC OFF ▾

EDMAC Slave Address: 0020

(TOP) CnC-APC Mode Disabled/De-activated  
(BOTTOM) CnC-APC Mode Enabled/Activated (Banner, Menu Bar not shown)

Figure 7-29. Configuration | Overhead Page

Use this page to configure the following interfaces:

- **AUPC** (when Carrier-in-Carrier Automatic Power Control is disabled/de-activated).



**Appendix E. AUPC (AUTOMATIC UPLINK POWER CONTROL)**

- **EDMAC** Framing Mode and Slave Address



**Appendix J. EDMAC CHANNEL**

- **CnC-APC (Carrier-in-Carrier Automatic Power Control)**



**Appendix G. DOUBLETALK CARRIER-IN-CARRIER OPTION**



**When CDM-570 Compatibility Mode is selected using the 'Configuration | Utilities' page (Sect. 7.4.3.3.8), CnC-APC is UNAVAILABLE and this page section is not visible.**

Click [**Submit**] to save.

### 7.4.3.3.8 Configuration | Utilities | Utilities 1

CDM-570A: Comtech EF Data Modem :: Utilities									
Home	Admin	Configuration	Status	ODU	Redundancy				
Modem	LAN	ARP	Routing	Managed Switch	WAN	Overhead	Utilities	BUC	LNB
Utilities 1	Carrier ID								
<b>Compatibility Mode</b> <input checked="" type="radio"/> CDM-570A Mode <input type="radio"/> CDM-570 Mode <input type="button" value="Submit"/>					<b>Re-Center Buffer</b> <input type="button" value="Re-Center Buffer"/>				
<b>Unit</b> Test Mode: <input type="text" value="Normal"/> Stats Sample Interval: <input type="text" value="Disabled"/> Front Panel Lockout: <input type="text" value="No_Lockout"/> RTS/CTS Control: <input type="text" value="RTS/CTS Loop, No Action"/> <input type="button" value="Submit Unit Utilities"/>					<b>Clocks</b> Tx Clock Source: <input type="text" value="Internal"/> Rx Buffer Size: <input type="text" value="Disabled"/> External Frequency Reference: <input type="text" value="Internal"/> G.703 Clock Extend Mode: <input type="text" value="None"/> G.703 Clock Extend Interface: <input type="text" value="E1Unbal"/> <input type="button" value="Submit Clocks"/>				
<b>Circuit ID</b> Circuit ID: <input type="text"/> <input type="button" value="Submit"/>					<b>Date &amp; Time</b> Time (Format is HH:MM:SS): <input type="text" value="10:33:06"/> Date (Format is DD/MM/YY): <input type="text" value="20/09/06"/> <input type="button" value="Enter Date/Time"/>				
<b>BERT Config</b> Tx: <input type="text" value="Off"/> Pattern: <input type="text" value="1:1"/> Rx: <input type="text" value="Off"/> Pattern: <input type="text" value="1:1"/> Error Insert: <input type="text" value="Off"/> <input type="button" value="Submit BERT"/>					<b>BERT Monitor</b> Errors: <b>0.00E+00</b> BER: <b>No Sync</b> Sync: <b>No Sync</b> <input type="button" value="Restart"/> <input type="button" value="Update"/>				
<b>Save / Load (Save takes precedence over Load)</b> <input type="button" value="Submit Save/Load"/> Save Location: <input type="text" value="Don't Save"/> Load Location: <input type="text" value="Don't Load"/>									

Figure 7-30. Configuration | Utilities | Utilities 1 Page

## Compatibility Mode

Because certain features of the CDM-570A/570AL Satellite Modem are not backward-compatible with the CDM-570 (70/140 MHz) and CDM-570L (L-Band) Satellite Modems, the CDM-570A/570AL provides a “compatibility mode” that is intended for use in existing networks that commingle operations of the CDM-570A/570AL and the CDM-570/L.

Use the option buttons top select **CDM-570A Mode** or **CDM-570 Mode**. Click **[Submit]** to execute the selection.

Be sure to take the following operational conditions into consideration when using Compatibility Mode operation:



1. **Use of CDM-0570 Compatibility Mode is NOT required if the CDM-570A/570AL is a component in a new or existing network that does NOT include CDM-570/L modems.**
2. **Certain page functionality becomes disabled or inaccessible while the modem is set to CDM-570 Compatibility Mode:**
  - **‘Configuration | Modem’ page (Sect. 7.4.3.3.1)**
    - **Transmit section: Tx Clock Invert**
    - **Receive section: Rx Clock Invert**
    - **Carrier-in-Carrier (CnC) section (including APC settings)**
  - **‘Configuration | Overhead’ page (Sect. 7.4.3.3.7)**
    - **CnC-APC section**
  - **‘Configuration | Utilities’ page (this section)**
    - **BERT Config section**
    - **BERT Monitor section**
3. **Certain feature options becomes disabled and unavailable while the modem is set to CDM-570 Compatibility Mode.**
  - **‘Configuration | Modem’ page (Sect. 7.4.3.3.1)**
    - **Transmit section:**
      - **Tx FEC Type – VersaFEC and ULL unavailable\***
      - **Tx Filter Rolloff Factor – Becomes fixed at 0.35**
    - **Receive section:**
      - **Rx FEC Type – VersaFEC and ULL unavailable\***
      - **Rx Filter Rolloff Factor – Becomes fixed at 0.35**

(\*FEC Type defaults to Viterbi; Modulation/Demodulation Types, FEC Code Rates, and Data Rates all adjust accordingly)
4. **Certain operational settings will reset to a default or fallback value when the modem is set to CDM-570 Compatibility Mode. You must be sure to reconfigure the modem to your previously configured settings.**
  - **‘Configuration | Modem’ page (CDM/R-570AL only) (Sect. 7.4.3.3.1)**
    - **Transmit section: Frequency value >2000 MHz resets to 1201 MHz**
    - **Receive section: Frequency value >2000 MHz resets to 1201 MHz**
  - **‘Configuration | Utilities’ page (this section)**
5. **Clocks section: If Internal plus output selected, resets to Internal.**

## Re-Center Buffer

Click **[Re-Center Buffer]** to force the re-centering of the Plesiochronous/Doppler buffer.

## Unit

Use the drop-down lists provided in this section to configure **Test Mode**, **Stats Sample Interval**, **Front Panel Lockout**, **RTS/CTS Control**, and **HSSI Handshake Control**.

Click **[Submit Unit Utilities]** to save.

## Clocks

Use the drop-down lists provided in this section to configure **Tx / Rx Clock Sources**, **Rx Buffer Size**, **External Clock**, **External Frequency Reference**, and **G.703 Clock Extended Mode / Interface**.



If “Internal plus output” is your active **External Frequency Reference** setting, and you then set the modem to **CDM-570 Compatibility Mode**, the modem will reset this feature to “Internal”. Reconfigure your setting as needed.

Click **[Submit Clocks]** to save.

## Circuit ID



It is **IMPORTANT** to understand that **Circuit ID** is a distinct feature of the **CDM-570A/570AL**. Read your documentation carefully.

Enter a *Circuit ID* string of up to 24 characters. You may use the following characters to compose either string:

[Space] ( ) \* + - , . / 0-9 and A-Z.

## Date & Time

- Enter a date using DD/MM/YY format (where DD = day [01 to 31], MM = month [01 to 12], and YY = year [00 to 99]).
- Enter a time using HH:MM:SS format (where HH = hour [00 to 23], MM = minutes [00 to 59], and SS = seconds [00 to 59]).

Click **[Enter Date/Time]** once you set the desired date and time.

## BERT Config

Use the drop-down lists provided in this section to configure *BERT* for **Tx** or **Rx** as **On** or **Off**; configure the *pattern* for **Tx** or **Rx**; and set *Error Insertion* as either **Off** or **10E-3**.

Click [**Submit BERT**] once you select the desired BERT settings.



Use of this feature is **UNAVAILABLE** when operating in **CDM-570 Compatibility Mode**. See Sect. 7.4.3.3.8 for further information.

## BERT Monitor

This **read-only** section displays the ongoing BERT. Click [**Restart**] to restart the BERT Monitor, or [**Update**] to refresh a test already in progress.



Use of this feature is **UNAVAILABLE** when operating in **CDM-570 Compatibility Mode**. See Sect. 7.4.3.3.8 for further information.

## Save / Load (Save takes precedence over Load)

As a safeguard, to prevent any inadvertent action the **Save Location** and **Load Location** drop-down lists' default selections are **Don't Save** and **Don't Load**, respectively. Otherwise:

- **Save Location / Load Location** – Use the drop-down lists to save or load up to 10 different modem configurations – **0** through **9**. An empty location is noted on its menu line as **Available**.

Click [**Submit Save/Load**] to save.

### 7.4.3.3.8.1 Configuration | Utilities | Carrier ID (MetaCarrier)



It is **IMPORTANT** to understand that **Carrier ID** is a distinct feature of the CDM-570A/570AL. Read your documentation carefully.

Note that in accordance with the DVB specifications, **Carrier ID** is only available when the Transmit symbol rate is greater than, or equal to **128 ksps**.



Appendix R. **CARRIER ID (MetaCarrier)**

CDM-570A: Comtech EF Data Modem :: Carrier ID									
Home	Admin	Configuration	Status	ODU	Redundancy				
Modem	LAN	ARP	Routing	Managed Switch	WAN	Overhead	Utilities	BUC	LNB
Utilities 1	Carrier ID								

**Meta-Carrier Info**

MAC Address: 00:06:B0:00:02:D7

Latitude:  °  '

Longitude:  °  '

Telephone Number:

Custom Message:

Carrier ID State:

**Figure 7-31. Configuration | Utilities | Carrier ID Page**

- **MAC Address** – This parameter is *read-only* and cannot be changed.
- **Latitude** – Enter a value, for degrees, from **0** to **90**. Enter a value, for minutes, from **00.00** to **59.99**. Use the drop-down list to select **N** (North) or **S** (South).
- **Longitude** – Enter a value, for degrees, from **0** to **180**. Enter a value, for minutes, from **00.00** to **59.99**. Use the drop-down list to select **E** (East) or **W** (West).
- **Telephone Number** – Enter a phone number. Valid characters are **+**, **x**, **0-9**.
- **Custom Message** – Enter a MetaCarrier Custom Message as needed, up to 24 characters. You may use the following characters to compose tis string:

[Space] ( ) \* + - , . / 0-9 and A-Z.

The MetaCarrier Custom Message, as created here, also appears in the title bar of compatible web browsers for easy unit identification.

- **Carrier ID State** – Use the drop-down list to set Carrier ID operation as **ON** or **OFF**.

Click **[Submit]** to save.

### 7.4.3.3.9 Configuration | BUC (CDM/R-570AL Only)



#### Chapter 10. CDM-570A/570AL ODU (TRANSCEIVER, BUC, LNB) M&C Operation

When a BUC is connected to a CDM/R-570AL (L-Band) Satellite Modem, you may use this page to configure its operating parameters and to view the BUC operational status.

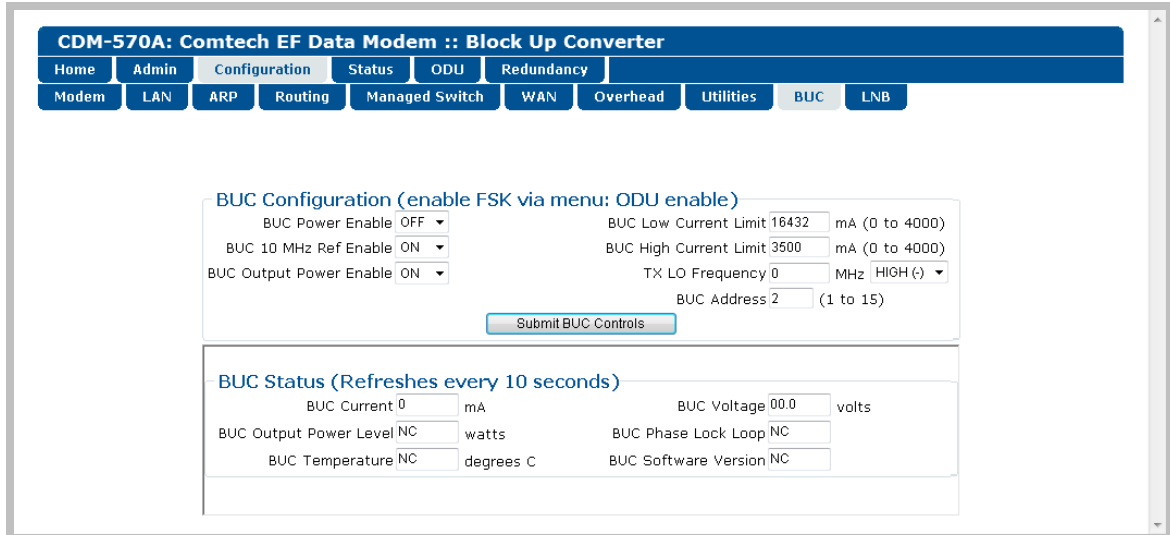

Figure 7-32. Configuration | BUC Page

### 7.4.3.3.10 Configuration | LNB (CDM/R-570AL Only)



#### Chapter 10. CDM-570A/570AL ODU (TRANSCIEVER, BUC, LNB) M&C Operation

When a LNB is connected to a CDM/R-570AL (L-Band) Satellite Modem, you may use this page to configure its operating parameters and to view the LNB operational status.

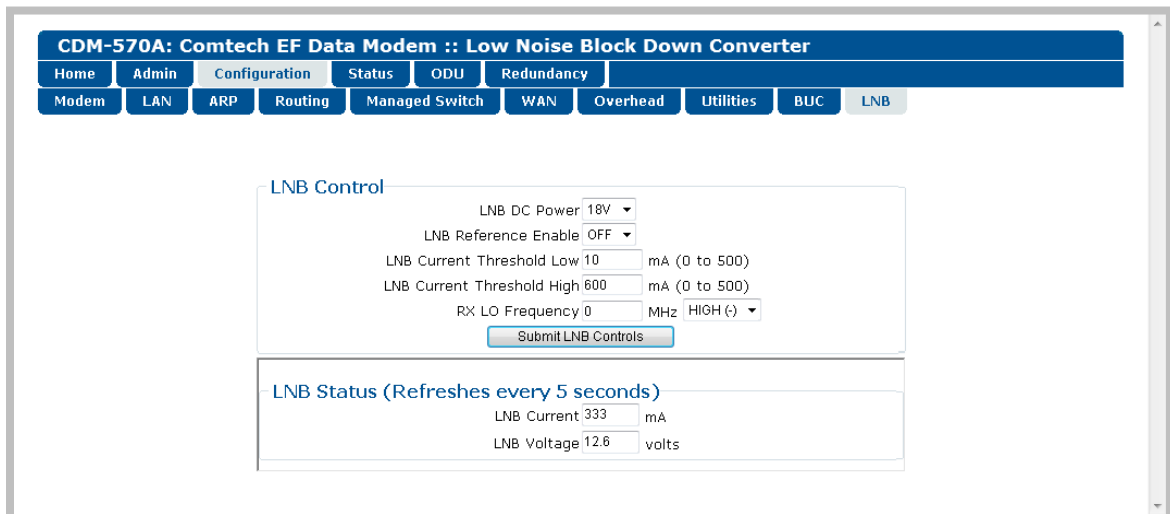

Figure 7-33. Configuration | LNB Page



### 7.4.3.4 Status Pages

The **Status** pages provide you with status, event logging, and operational statistics windows. Click the **Modem Status**, **System Logs**, **Modem Info**, **Traffic Statistics**, **Performance**, or **Graph** tab to continue.

#### 7.4.3.4.1 Status | Modem Status

Use this page to view *read-only* status window pertaining to:

- Alarms
- CnC
- Fractional CnC Counters
- Rx Parameters
- AUPC
- General Status
- ACM (not active for RS422, IP, V.35, RS232, and G703)

CDM-570A: Comtech EF Data Modem :: Modem Status			
Home	Admin	Configuration	Status
Modem Status		System Logs	Modem Info
		Traffic Statistics	Performance
		Graph	
<b>Alarms</b>		<b>RX Parameters</b>	
Unit:	None	BER:	Demod Unlocked
Tx:	None	Eb/No:	Demod Unlocked
Rx:	Demod Lock	Freq Offset:	Demod Unlocked
ODU:	None	Signal Level:	LT99 dBm
		Buffer Fill State:	Demod Unlocked
<b>AUPC</b>		<b>CnC</b>	
Remote Eb/No:	EDMAC Disabled	Delay:	Demod Unlocked
Tx Power Level Increase:	AUPC Disabled	Offset:	Demod Unlocked
		Power Ratio:	Demod Unlocked
		PSDR:	Demod Unlocked
<b>ACM</b>		<b>General Status</b>	
Tx ModCod:	Not in ACM	Redundancy:	Online
Rx ModCod:	Not in ACM	Temperature:	+30 °C
Remote SNR:	Not in IP-ACM	Events Log, Unread Lines:	255
Local SNR:	Not in IP-ACM		
<b>Fractional CnC Counters</b>			
1-year Operational Counter:	Fractional CnC not installed		
90-day CnC usage Counter:	Fractional CnC not installed		

Figure 7-34. Status | Modem Status Page (VersaFEC ACM (IP-ACM) or VersaFEC-2 ACM (V2-ACM) Mode Not Active)

Use this page to view **read-only** status window pertaining to:

- Alarms
- CnC
- Fractional CnC Counters
- Rx Parameters
- ACM (active)
- AUPC
- General Status

CDM-570A: Comtech EF Data Modem :: Modem Status			
Home	Admin	Configuration	Status
Modem Status	System Logs	Modem Info	Traffic Statistics
		Performance	Graph
<b>Alarms</b>		<b>RX Parameters</b>	
Unit:	None	BER:	Demod Unlocked
Tx:	None	Eb/No:	Demod Unlocked
Rx:	Demod Lock	Freq Offset:	Demod Unlocked
ODU:	None	Signal Level:	LT99 dBm
		Buffer Fill State:	Demod Unlocked
<b>AUPC</b>		<b>CnC</b>	
Remote Eb/No:	EDMAC Disabled	Delay:	Demod Unlocked
Tx Power Level Increase:	AUPC Disabled	Offset:	Demod Unlocked
		Power Ratio:	Demod Unlocked
		PSDR:	Demod Unlocked
<b>ACM</b>		<b>General Status</b>	
Tx ModCod:	00 BPSK 0.488	Redundancy:	Online
Rx ModCod:	00 BPSK 0.488	Temperature:	+30 °C
Remote SNR:	No Sync	Events Log, Unread Lines:	255
Local SNR:	No Sync		
<b>Fractional CnC Counters</b>			
1-year Operational Counter:	Fractional CnC not installed		
90-day CnC usage Counter:	Fractional CnC not installed		

**Figure 7-35. Status | Modem Status Page (VersaFEC ACM (IP-ACM) or VersaFEC-2 ACM (V2-ACM) Mode Active)**

### 7.4.3.4.2 Status | System Logs | Modem



#### Chapter 6. FRONT PANEL OPERATION

Use this page to review logged operational events and statistics, and to control how the fault, statistics, and alarm masking parameters are processed by the modem.

**CDM-570A: Comtech EF Data Modem :: Modem Logs**

Home
Admin
Configuration
Status
ODU
Redundancy

Modem Status
System Logs
Modem Info
Traffic Statistics
Performance
Graph

Modem

**Events Log**

Read Next Five Events  
 Clear Events Log  
 Initialize Events Pointer

No New Entry

Unread Events

**Statistics Log**

Read Next Five Statistics  
 Clear Statistics Log  
 Initialize Statistics Pointer

No New Entry

Unread Statistics

**Alarm Mask**

**Tx FIFO**

 Masked  
 Active

**Tx AIS**

 Masked  
 Active

**G.703 BPV**

 Masked  
 Active

**G.703 LOS**

 Masked  
 Active

**Rx AGC**

 Masked  
 Active

**Rx AIS**

 Masked  
 Active

**Eb/No**

 Masked  
 Active

**Buffer Slip**

 Masked  
 Active

**Reference**

 Masked  
 Active

**BUC**

 Masked  
 Active

**LNB**

 Masked  
 Active

Figure 7-36. Status | System Logs | Modem Page

## Events Log

- **Read Next Five Events** – Click to buffer the next group of five stored events into the scrollable, *read-only* events window.
- **Clear Events Log** – Click to erase all entries from the stored events log.
- **Initialize Events Pointer** – Click to reset the Event Log's internal pointer.

Click **[Submit]** to save.

- **Unread Events** – This scrollable, *read-only* window displays the total number of *unread* stored events. As stored event groups are displayed, the counter decrements accordingly.

## Statistics Log



If you change your operating mode between Non-ACM and ACM (VersaFEC ACM (IP-ACM) or VersaFEC-2 ACM (V2-ACM)) mode, Comtech EF Data recommends that you execute the Clear Statistics Log feature before retrieving any further statistics.

- **Read Next Five Statistics** – Click to buffer the next group of five stored events into the scrollable, *read-only* statistics window.
- **Clear Statistics Log** – Click to erase all entries from the stored Statistics Log.
- **Initialize Statistics Pointer** – Click to reset the Statistics Log's internal pointer.

Click **[Submit]** to save.

- **Unread Statistics** – This scrollable, *read-only* window displays the total number of *unread* stored statistics. As stored statistics are displayed, the counter decrements accordingly.

## Alarm Mask

Use the available option buttons to designate an alarm as **Masked** or **Active**. Click **[Submit Alarm Mask]** to save.

### 7.4.3.4.3 Status | Modem Info

This page displays *read-only* information about the currently configured modem:

- **General Information**
- **Equipment ID**
- Scrollable windows listing **Options – Installed** and the available **Options – Not Installed**.

CDM-570A: Comtech EF Data Modem :: Modem Information						
Home	Admin	Configuration	Status	ODU	Redundancy	
Modem Status	System Logs	Modem Info	Traffic Statistics	Performance	Graph	

General Information	
Circuit ID:	-----
Serial Number:	100000000
Software Revision:	1.5.1
Active Software Image:	Image 2
Hardware Revision:	0.20F
Local/Remote:	Ethernet Remote
Front Panel Lockout:	No lockout

Equipment ID	
Modem model number:	CDM-570AL
Data Rate & VF2 data rate:	up to 10239kbps
Tx Roll Off Factor data rate:	up to 10239kbps
CnC data rate:	up to 10239kbps
VersaFEC data rate:	up to 10239kbps
IP-ACM & VF2-ACM symbol rate:	up to 3000ksps
<b>Options - Installed</b>	<b>Options - Not Installed</b>
Turbo Code Rate 0.95 Card Carrier-in-Carrier Card Expansion Card Packet Processor Card All TPC Code Rate Reed-Solomon Codec VersaFEC Codec VersaFEC-2 Codec Modulation: BPSK, (0)QPSK, 8QAM, 8-PSK, 16QAM, 8ARY, 16ARY, 32ARY	Fractional Carrier-in-Carrier BUC Power Supply

Figure 7-37. Status | Modem Info Page

### 7.4.3.4.4 Status | Traffic Statistics Pages

These pages are available only when the optional Packet Processor is INSTALLED. Click the Ethernet, Router, WAN, Compression, QoS, or Clear Counter tab to continue.

#### 7.4.3.4.4.1 Status | Traffic Statistics | Ethernet

Use this page to review the cumulative Transmit/Receive Statistics, Performance, and Errors for the active Ethernet ports.

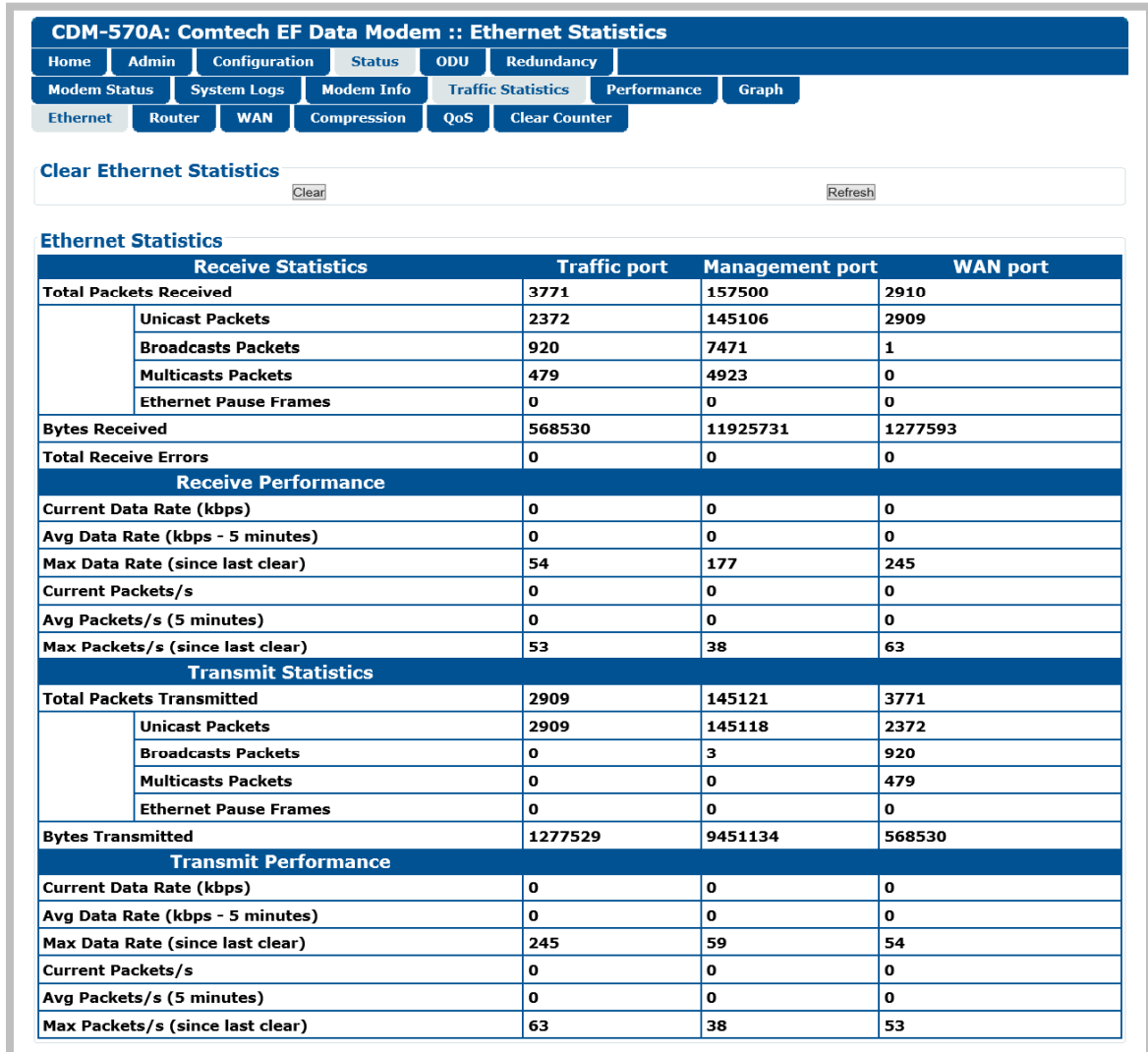

Figure 7-38. Status | Traffic Statistics | Ethernet Page (upper section)

Error Details			
Receive Errors	Traffic port	Management port	WAN port
LAN FCS Error	0	0	0
Alignment Error	0	0	0
Undersize	0	0	0
Fragments	0	0	0
Jabber	0	0	0
Oversize	0	0	0
InDiscards	0	0	0
Transmit Errors			
Single Collision	0	0	0
Multiple Collisions	0	0	0
Excessive Collisions	0	0	0

Figure 7-39. Status | Traffic Statistics | Ethernet Page (lower section)

### Clear Ethernet Statistics

Clear Ethernet Statistics

Click **[Clear]** to erase all existing information and reset the statistics compilation buffer. Otherwise, click **[Refresh]** to update the page with the latest polled data.

### 7.4.3.4.4.2 Status | Traffic Statistics | Router

Use this page to review the cumulative routed, dropped, or filtered packets as processed by the modem while in Router Mode.

**CDM-570A: Comtech EF Data Modem :: Router Statistics**

Home
Admin
Configuration
Status
ODU
Redundancy

Modem Status
System Logs
Modem Info
Traffic Statistics
Performance
Graph

Ethernet
Router
WAN
Compression
QoS
Clear Counter

**Clear Statistics**

**Router Counters**

Description	Packets
From Ethernet - Total	3875
To Ethernet - Total	2973
To Ethernet - Unicast	2973
To Ethernet - Multicast	0
To Ethernet - Broadcast	0
From Satellite - Total	0
To Satellite - Total	958
To Satellite - Unicast	16
To Satellite - Multicast	0
To Satellite - Broadcast	0
From Endstation - Total	2976
To Endstation - Total	3354
Received IGMP Packets	0
Received IP Options Packets	0

**Dropped Packets**

Description	Packets
Bad IP Header Checksum	0
Bad Buffer Length	0
Bad IP Version	0
TTL Expired	0
No Route	0
No ARP Entry	0
Filtered Multicast	0
Multicast Disable Group	0
EasyConnect Multicast Option	486
Router Queue Full	0
<b>Total Dropped</b>	<b>486</b>

Figure 7-40. Status | Traffic Statistics | Router Page (upper section)



Filtered Packets	
Description	Packets
Boot	1
Flow Descriptor	0
Unknown Reason Code	0
Flow Correlator	0
Management Path	0
Wan Scaling	0
Ping	0
Access Control	0
Vipersat MCP	0
Vipersat UCP	0
Codeload	0
Multicast	0
Bad Packets	0
Route	0
Vipersat Remote	0
QoS Rule	0
Vipersat Loop	0
Bad Header Len	0
Bad Data Ptr	0
MAC Split Err	0
L3Type Err	0
Local Destination	0
Redundancy Err	0
ICMP Filter	0
Port Err	0
Per port route rule	0
Total Filtered	1

Figure 7-41. Status | Traffic Statistics | Router Page (lower section)

### Clear Statistics

Clear Statistics

Click **[Clear]** to erase all existing information and reset the statistics counters. Otherwise, click **[Refresh]** to update the page with the latest polled data.

### 7.4.3.4.4.3 Status | Traffic Statistics | WAN

Use this page to review the cumulative WAN statistics.

**CDM-570A: Comtech EF Data Modem :: WAN Statistics**

Home Admin Configuration Status ODU Redundancy

Modem Status System Logs Modem Info Traffic Statistics Performance Graph

Ethernet Router WAN Compression QoS Clear Counter

**Clear Statistics**

**Rx Counters**

Description	Counters
Pkt Processor CRC Error Count	0
Abort/Octet Error Count	0
Overrun Count	0
HDLC CRC Error Count	0
HDLC Payload Bytes	0
HDLC Header Bytes	0
HDLC Packet Count	0
HDLC HW Payload Bytes	0
HDLC HW Header Bytes	0
HDLC HW Packet Count	0
HDLC Address Match Packet Count	0
HDLC Address Filtered Packet Count	0
DMA Reclaim	0

**Rx Errors**

Description	Errors
Invalid Flow Id Errors	0
SAR Reassemble Errors	0
Header Decompression Errors	0
Memory Alignment Errors	0
Bad CRC Errors	0

**Tx Counters**

Description	Counters
HDLC Header Bytes	4327
HDLC Payload Bytes	97922
HDLC Packet Count	958
DMA Reclaim	0

**WAN Utilization**

Description	Counters
WAN Utilization	0 %
LAN to WAN Traffic	0 kbps
Actual WAN traffic	0 kbps
WAN Bandwidth Saved	0 %

Figure 7-42. Status | Traffic Statistics | WAN Page

#### Clear Statistics

Click **[Clear]** to erase all existing information and reset the statistics counters. Otherwise, click **[Refresh]** to update the page with the latest polled data.

### 7.4.3.4.4 Status | Traffic Statistics | Compression

When this FAST option is available, use this page to review the cumulative Header and Payload Compression statistics.

**CDM-570A: Comtech EF Data Modem :: Compression Statistics**

Home
Admin
Configuration
Status
ODU
Redundancy

Modem Status
System Logs
Modem Info
Traffic Statistics
Performance
Graph

Ethernet
Router
WAN
Compression
QoS
Clear Counter

**Clear Compression Counters**

**Compression Statistics**

Index	Pre-Hdr Comp. Bytes	Post-Hdr Comp. Bytes	Hdr Comp. Savings (%)	Pre-Payload Comp. Bytes	Post-Payload Comp. Bytes	Payload Comp. Ratio
1	0	0	0.00	0	0	1:1.00
2	0	0	0.00	0	0	1:1.00
3	0	0	0.00	0	0	1:1.00
4	0	0	0.00	0	0	1:1.00
5	0	0	0.00	0	0	1:1.00
6	0	0	0.00	0	0	1:1.00
7	0	0	0.00	0	0	1:1.00
8	0	0	0.00	0	0	1:1.00
9	0	0	0.00	0	0	1:1.00
10	0	0	0.00	0	0	NA

Figure 7-43. Status | Traffic Statistics | Compression Page

#### Clear Compression Counters

Click **[Clear]** to erase all existing information and reset the statistics counters. Otherwise, click **[Refresh]** to update the page with the latest polled data.

### 7.4.3.4.4.5 Status | Traffic Statistics | QoS

The appearance of this page depends on whether you enable or disable the QoS Feature operation using the 'Configuration | WAN | QoS' page (Sect. 7.4.3.3.6.1).

**CDM-570A: Comtech EF Data Modem :: QoS Statistics**

Home Admin Configuration Status ODU Redundancy

Modem Status System Logs Modem Info Traffic Statistics Performance Graph

Ethernet Router WAN Compression QoS Clear Counter

Clear **Clear QoS Counters** Refresh

**QoS Statistics**

Index	Sent Packets	Sent Packets / sec	Sent Bytes	Dropped Packets	Dropped Bytes	Current Tx Rate	Average Tx Rate	Max Tx Rate	Active Flows

**CDM-570A: Comtech EF Data Modem :: QoS Statistics**

Home Admin Configuration Status ODU Redundancy

Modem Status System Logs Modem Info Traffic Statistics Performance Graph

Ethernet Router WAN Compression QoS Clear Counter

Clear **Clear QoS Counters** Refresh

**QoS Statistics**

Index	Sent Packets	Sent Packets / sec	Sent Bytes	Dropped Packets	Dropped Bytes	Current Tx Rate	Average Tx Rate	Max Tx Rate	Active Flows
1	815	0	89547	0	0	0	0	7	0

(TOP) QoS Feature = Disable  
(BOTTOM) QoS Feature = Enable

Figure 7-44. Status | Traffic Statistics | QoS Page

#### Clear QoS Counters

Click **[Clear]** to erase all existing information and reset the statistics counters. Otherwise, click **[Refresh]** to update the page with the latest polled data.

### 7.4.3.4.4.6 Status | Traffic Statistics | Clear Counter

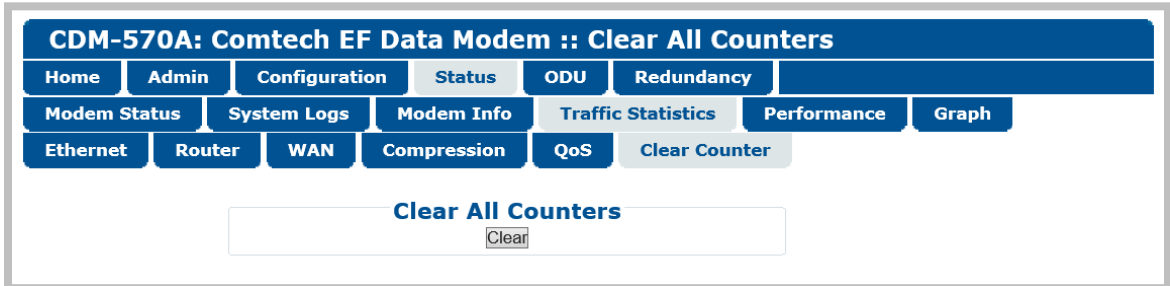

Figure 7-45. Status | Traffic Statistics | Clear Counter Page

Click **[Clear]** to erase all existing information and reset the statistics compilation buffers from all Traffic Statistics pages (Ethernet, Router, WAN, Compression, and QoS).

### 7.4.3.4.5 Status | Performance

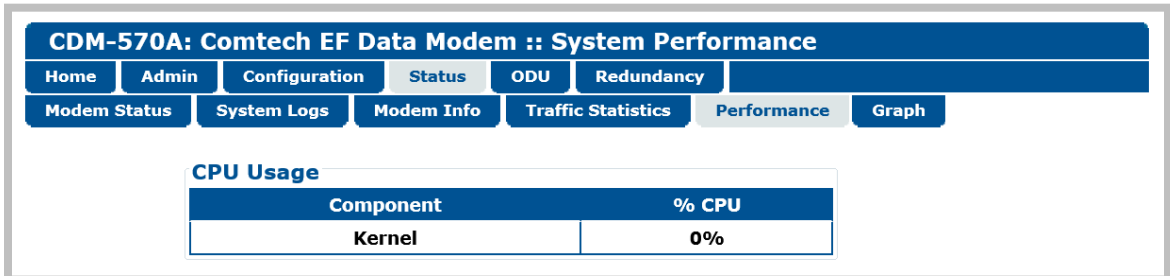

Figure 7-46. Status | Performance Page

#### CPU Usage

This *read-only* page displays IP Module CPU Utilization as a percentage(%).

### 7.4.3.4.6 Status | Graph Pages

The **Graph** pages provide you with real-time visual monitoring of modem signal operation. Click the **Constellation** or **Spectrum** tab to continue.

#### 7.4.3.4.6.1 Status | Graph | Constellation

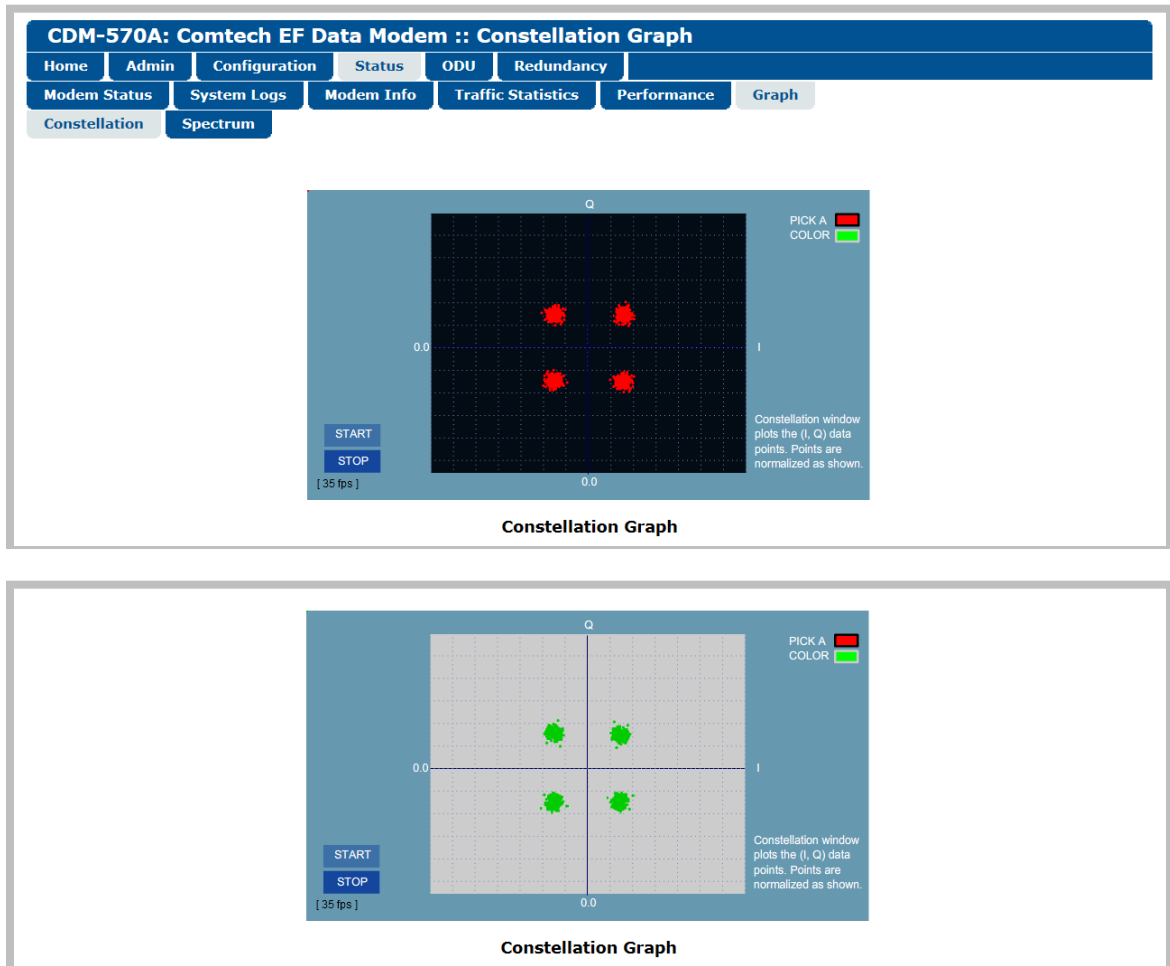

(TOP) Constellation Graph “PICK A COLOR” = (RED)  
(BOTTOM) Constellation Graph “PICK A COLOR” = (GREEN) (Banner, Menu Bar not shown)

**Figure 7-47. Status | Graph | Constellation Page**

Use this page to display the real-time Ethernet Rx IQ constellation monitor:

- **First**, configure the graph appearance in the upper right-hand side (“PICK A COLOR”). Click the **red box** to display a red constellation pattern on a black/gray grid. Click the **green box** to display a green constellation pattern on a gray/blue grid.
- **Then**, click **[START]** to activate or **[STOP]** to pause the Constellation monitoring function.

### 7.4.3.4.6.2 Status | Graph | Spectrum

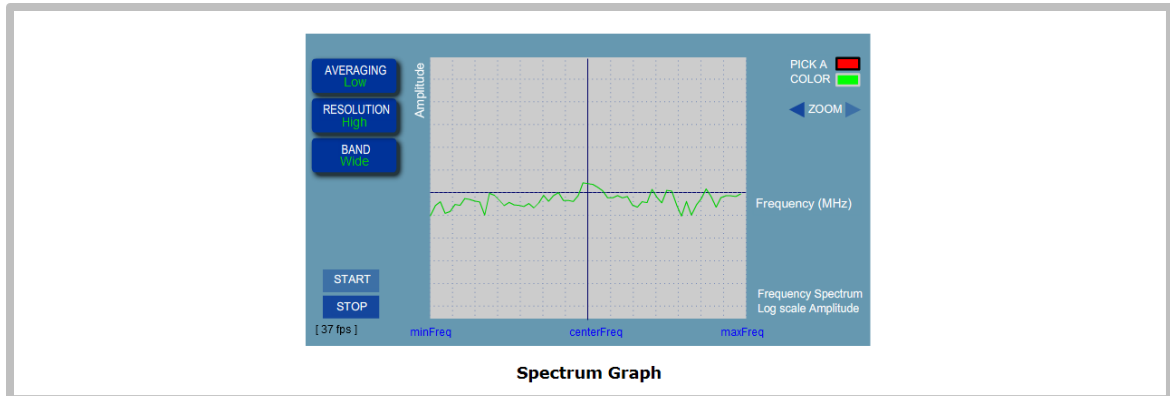
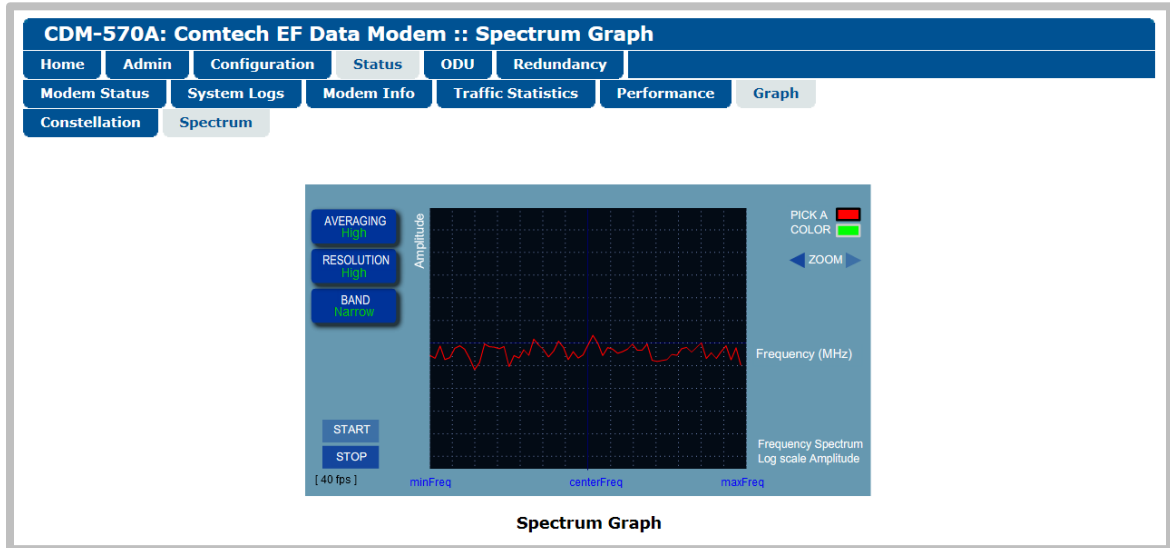

**(TOP) Spectrum Graph “PICK A COLOR” = (RED), AVERAGING=High, RESOLUTION=High, BAND=Narrow**  
**(BOTTOM) Spectrum Graph “PICK A COLOR” = (GREEN), AVERAGING=Low, RESOLUTION=High, BAND=Wide (Banner, Menu Bar not shown)**

**Figure 7-48. Status | Graphs | Spectrum Page**

Use this page to display the real-time Spectrum Analyzer. Customize the display as follows:

Feature	Description	Setting
“PICK A COLOR”	Click RED or GREEN to define the overall appearance of the graph.	<ul style="list-style-type: none"> <li>RED waveform on a BLACK/GRAY grid</li> <li>GREEN waveform on a GRAY/BLUE grid</li> </ul>
AVERAGING	Allows you to select the averaging of the FFT spectrum.	Select Off, Low, Medium, or High
RESOLUTION	Allows you to adjust the output resolution.	Select Low, Medium, or High
BAND	Allows you to select the bandwidth span.	Select Narrow or Wide

Click **[START]** to activate or **[STOP]** to pause the Spectrum Analyzer function.

### 7.4.3.5 ODU Pages Summary (CDM-570A Only)



After enabling ODU Comms operations, you may use the 'ODU' pages to control and monitor the CSAT-5060 or KST-2000A/B Outdoor Unit that is connected via FSK to the CDM-570A (70/140 MHz) Satellite Modem.



See Chapter 10. CDM-570A/570AL ODU (TRANSCEIVER, BUC, LNB) M&C Operation for complete details on using the HTTP Interface for ODU operations.

The figure shows four overlapping screenshots of the ODU management interface:

- Top Screenshot (Enable):** Shows the 'ODU Comms Enable' page with navigation tabs for Home, Admin, Configuration, Status, ODU, and Redundancy. The 'ODU' tab is active, and sub-tabs for Enable, Config, Status, and Utilities are visible.
- Second Screenshot (Config):** Shows the 'CSAT-5060 Configuration' page. It includes an 'ODU Selection' dropdown set to 'CSAT#1' and a 'Select ODU' button. The selected unit is 'CSAT-5060/010 2.35 C042149170 SINGLE'.
- Third Screenshot (Status):** Shows the 'CSAT-5060 Status' page. It features a table with 'Maintenance Parameters' and 'ODU Alarms'.
 

Maintenance Parameters		ODU Alarms					
24V:	24.4 V	10MHz Reference:	04.7 V	24V:	OK	External Reference:	OK
20V:	23.0 V	Tx Synthesizer:	09.7 V	20V:	OK	Tx Synthesizer:	OK
12V:	12.9 V	Tx IFLO:	06.8 V	12V:	OK	Tx IFLO:	OK
10V:	10.1 V	Rx Synthesizer:	05.8 V	10V:	OK	Rx Synthesizer:	OK
- Bottom Screenshot (Utilities):** Shows the 'CSAT-5060 Utilities' page. It includes 'ODU Selection' (CSAT#1), 'Force 1:1 Switch', and 'Recalibrate LNA Current' buttons. It also has a 'Redundancy Box Mode' section with radio buttons for 'Automatic' and 'Manual', and an 'ODU Date & Time' section with input fields for Time (08:27:03) and Date, and an 'Enter Date/Time' button. At the bottom, there is an 'ODU Stored Events' section with radio buttons for 'Read Next Five Events', 'Clear Stored Events', and 'Initialize Events Pointer', and a 'Submit' button. A log viewer shows 'LOG CLEAR IF 082715 061613' and 'Unread Events -35'.

Figure 7-49. ODU Page Examples (Enable, Config, Status, and Utilities)



### 7.4.3.6 Redundancy Page



1. This page is functional only when a Comtech EF Data Redundancy Switch is connected to the CDM-570A/570AL in a redundant configuration:
  - 1:1 Redundancy is supported using either a CRS-170A L-Band 1:1 Redundancy Switch (when using CDM/R-570AL modems) or a CRS-180 70/140 MHz 1:1 Redundancy Switch (when using CDM-570A modems), and a user-provided, off-the-shelf Ethernet switch.
  - 1:N Redundancy is supported only for serial data using a CRS-300/CRS-280L 1:10 Redundancy Switch (when using CDM/R-570AL modems) or a CRS-300/CRS-280 1:10 Redundancy Switch (when using CDM-570A modems).
2. Refer to your actual Comtech EF Data Switch Installation and Operation Manual for detailed information on setting up and using the CDM-570A/570AL in a redundancy configuration.
3. If you submit any changes to this page when the optional Packet Processor is INSTALLED, you must also open the 'Admin | Pap Save' page (see Sect. 7.4.3.2.8) and immediately click [Save PaP Parameters].

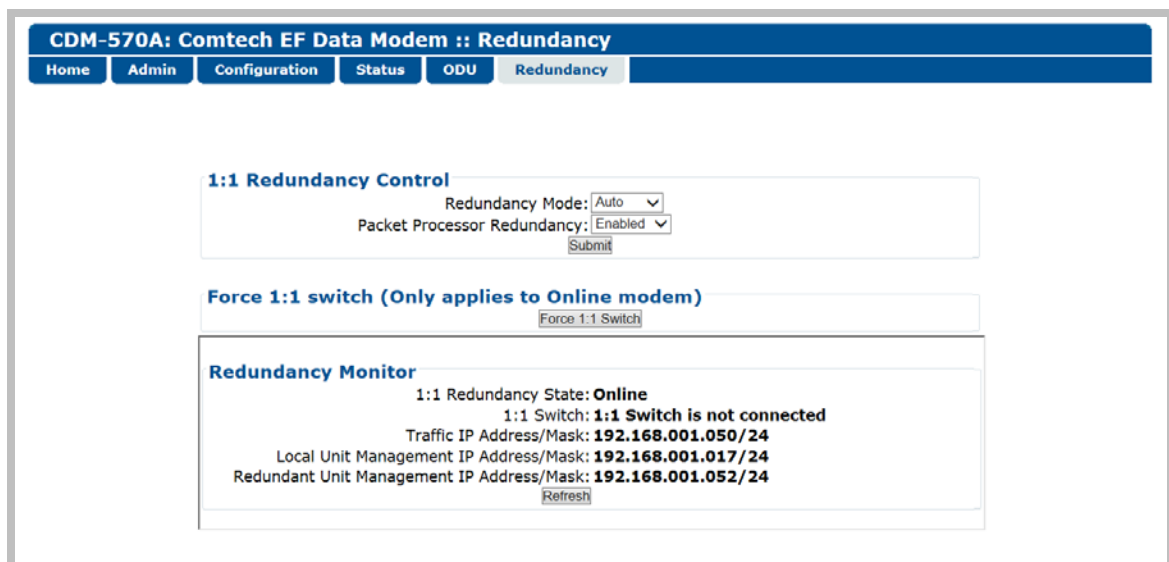

Figure 7-50. Redundancy Page

#### 1:1 Redundancy Control

- **Redundancy Mode** – Use the drop-down list to set Redundancy mode as **Auto** or **Manual**.
- **Packet Processor Redundancy** – When the optional Packet Processor is INSTALLED, Use the drop-down list to set operation as **Disabled** or **Enabled**.

Click [Submit] to save.



Make sure to also click **[Save PaP Parameters]** on the 'Admin | PaP Save' page before proceeding further.

### **Force 1:1 switch (Only applies to Online modem)**

This page section is valid for use with the *Online* unit in a 1:1 pair.

When you are using redundant modems and this active unit is currently the *Online* unit, click **[Force 1:1 Switch]** to force a switchover – i.e., to place this unit into *Offline* (standby) mode.

### **Redundancy Monitor**

This page section automatically updates every five seconds. You may otherwise click **[Refresh]** to manually update the section. It provides real-time monitoring of the redundancy setup.

This **read-only** section displays:

- The status of the active modem (i.e., *Online* or *Offline*)
- The detected presence of a redundancy switch
- The configured IP Addresses and Masks.

When Packet Processor Redundancy is **active**, this section additionally displays the Local Unit and Redundant Unit IP Addresses and Masks in addition to the Traffic IP Address/Mask.

# Chapter 8. SERIAL-BASED REMOTE PRODUCT MANAGEMENT

---

## 8.1 Overview

The CDM-570A/570AL Satellite Modem serial remote product management interface is an electrical interface that is either an EIA-485 multi-drop bus (for the control of multiple devices) or an EIA-232 connection (for the control of a single device). The interface transmits data in asynchronous serial form, using ASCII characters. This data consists of control and status information, transmitted in packets of variable length in accordance with the structure and protocol explained later in this chapter.

---

## 8.2 EIA-485

For applications where multiple devices are to be monitored and controlled, a full-duplex (or 4-wire plus ground) EIA-485 is preferred. Half-duplex (2-wire plus ground) EIA-485 is possible, but is not preferred. In full-duplex EIA-485 communication, there are two separate, isolated, independent, differential-mode twisted pairs, each handling serial data in different directions.

It is assumed that a 'Controller' device (a PC or dumb terminal) transmits data in a broadcast mode via one of the pairs. Multiple 'Target' devices are connected to this pair, and all simultaneously receive data from the Controller. The Controller is the only device with a line-driver connected to this pair – the Target devices have only line-receivers connected.

In the other direction, on the other pair each Target has a tri-state line driver connected, and the Controller has a line-receiver connected. All the line drivers are held in high-impedance mode until one (and only one) Target transmits back to the Controller. Each Target has a unique address, and each time the Controller transmits, the address of the intended recipient Target is included in a framed 'packet' of data. All of the Targets receive the packet, but only one (the intended) will reply. The Target enables its output line driver and transmits its return data packet back to the Controller in the other direction, on the physically separate pair.

**EIA-485 (full duplex) summary:**

Two differential pairs	One pair for Controller-to-Target, one pair for Target-to-Controller.
Controller-to-Target pair	One line driver (Controller), and all Targets have line receivers.
Target-to-Controller Pair	One line receiver (Controller), and all Targets have Tri-State drivers.

---

**8.3 EIA-232**

This is a much simpler configuration in which the Controller device is connected directly to the Target via a two-wire-plus-ground connection. Controller-to-Target data is carried, via EIA-232 electrical levels on one conductor, and Target-to-Controller data is carried in the other direction on the other conductor.

---

**8.4 Basic Protocol**

Whether in EIA-232 or EIA-485 mode, all data is transmitted as asynchronous serial characters, suitable for transmission and reception by a Universal Asynchronous Receiver/Transmitter (UART). The asynchronous character format is 8-N-1 (8 data bits, no parity, 1 stop bit). The baud rate may vary from 1200 to 57600 baud.

All data is transmitted in framed packets. The Controller is in charge of the process of monitor and control, and is the only device that is permitted to initiate, at will, the transmission of data. Targets are only permitted to transmit when they have been specifically instructed to do so by the Controller.

All bytes within a packet are printable ASCII characters, less than ASCII code 127. In this context, the Carriage Return and Line Feed characters are considered printable.

All messages from Controller-to-Target require a response, with one exception: This will be either to return data that has been requested by the Controller, or to acknowledge reception of an instruction to change the configuration of the Target. The exception to this is when the Controller broadcasts a message (such as Set Time/Date) using Address 0, when the Target is set to EIA-485 mode.

### 8.4.1 Packet Structure

The exchange of information is transmitted, Controller-to-Target and Target-to-Controller, in ‘**packets**’. Each packet contains a finite number of bytes consisting of printable ASCII characters, excluding ASCII code 127 (DELETE).

In this context, the Carriage Return and Line Feed characters are considered printable. With one exception, all messages from Controller-to-Target require a response – this will be either to return data that has been requested by the Controller, or to acknowledge reception of an instruction to change the configuration of the Target.

Controller-to-Target						
Start of Packet	Target Address	Address Delimiter	Instruction Code	Code Qualifier	Optional Arguments	End of Packet
< ASCII code 60 (1 character)	(4 characters)	/ ASCII code 47 (1 character)	(3 characters)	= or ? ASCII codes 61 or 63 (1 character)	(n characters)	Carriage Return ASCII code 13 (1 character)

**Packet “issued command” example:** <0000/RSW=32[cr]

**Packet “issued query” example:** <0000/RSW?[cr]

Target-to-Controller						
Start of Packet	Target Address	Address Delimiter	Instruction Code	Code Qualifier	Optional Arguments	End of Packet
> ASCII code 62 (1 character)	(4 characters)	/ ASCII code 47 (1 character)	(3 characters)	=, ?, !, or * ASCII codes 61, 63, 33, or 42 (1 character)	(From 0 to n characters)	Carriage Return, Line Feed ASCII codes 13,10 (2 characters)

**Packet example – response received for issued query:** >0000/RSW=32[cr][lf]

Detailed description of the packet components follow.

---

### 8.4.1.1 Start of Packet

Controller-to-Target	This is the character '<' (ASCII code 60).
----------------------	--

Target-to-Controller	This is the character '>' (ASCII code 62).
----------------------	--

The '<' and '>' characters indicate the start of packet. They may not appear anywhere else within the body of the message.

---

### 8.4.1.2 Target Address

Up to 9999 devices can be uniquely addressed. In EIA-232 applications this value is set to 0000. In EIA-485 applications, the permissible range of values is 0001 to 9999. It is programmed into a Target unit using the front panel keypad.



**The Target Address designates the packet destination. The Controller does not have its own address. After the Controller sends a packet with the designated Target Address, the Target responds to the Controller, using this same address, to indicate the source of the packet.**

---

### 8.4.1.3 Address Delimiter

This is the “forward slash” character '/' (ASCII code 47).

---

### 8.4.1.4 Instruction Code

This is a three-character alphanumeric sequence that identifies the message subject. Uppercase alphabetic characters ('A' to 'Z', ASCII Codes 65 to 90) and the numbers '0' to '9' (ASCII Codes 48 to 57) may be used. Wherever possible, each instruction code is named to serve as a mnemonic for its intended operation. This helps you interpret the code function, should it be shown in its raw ASCII form.

**For example: MLC** for **M**anagement **L**ink **C**onfiguration, **IPA** for Management **IP** Address, etc.

---

### 8.4.1.5 Instruction Code Qualifier

This is a single character that further qualifies the preceding instruction code.

1. From **Controller-to-Target**, the only permitted values are:

Symbol	Function
= (ASCII Code 61)	The '=' code is used as the Assignment Operator (AO). It establishes that the Instruction Code that precedes it is issued as a <b>command</b> to assign or configure operation. The instruction set that follows serves to assign the Target's new parameter setting or operational value. <b>For example:</b> From Controller-to-Target, <0/IG1=aaa.bbb.ccc.ddd/yy means "set the 'ETHERNET   TRAFFIC  GE' port IP Address to aaa.bbb.ccc.ddd/yy"
? (ASCII Code 63)	The '?' code is used as the Query Operator (QO). It establishes that the Instruction Code that precedes it is issued as a <b>query</b> that returns the Target's current configured parameter setting or operational value. <b>For example:</b> From Controller-to-Target, <0/IG1? means "what is the current 'ETHERNET   TRAFFIC  GE' port IP Address?"

2. From **Target-to-Controller**, the only permitted values are:

Symbol	Function
= (ASCII Code 61)	This code is used in two ways: <ol style="list-style-type: none"> <li>If the Controller sends a query to the Target. <b>For example:</b> &lt;0/TFQ? (meaning "what is the current value of the transmit frequency?") – the Target responds with &gt;0000/TFQ=xxxx.xxxx, the value for that queried parameter.</li> <li>If the Controller sends an instruction to set a parameter to a particular value, and the value sent is valid, the Target acknowledges the message and responds with, for example, &gt;0000/TFQ = (with no message arguments).</li> </ol>
? (ASCII Code 63)	If the Controller issues a command to set a parameter to a particular value, and the value sent is not valid, the Target then acknowledges the message and responds with '?'. This indicates that there was an error in the message sent by the Controller. <b>For example:</b> >0000/TFQ? (with no message arguments).
! (ASCII Code 33)	If the Controller issues a command that the Target does not recognize, the Target responds by echoing the invalid instruction code, followed by '!'. <b>For example:</b> >0000/ABC!
* (ASCII Code 42)	If the Controller issues a command to set a parameter to a particular value, and the value sent is valid, but the modem will not permit that particular parameter to be changed at present, the Target responds by echoing the valid instruction code, followed by '*'. <b>For example:</b> >0000/TFQ* (with message arguments)
# (ASCII Code 35)	If the Controller sends a correctly formatted command, but the Target is not in Remote Mode, the unit does not allow reconfiguration and responds by echoing the valid instruction code, followed by '#'. <b>For example:</b> >0000/TFQ#

Symbol	Function
~ (ASCII Code 126)	If a message is sent via a local modem to a distant-end device or ODU, the message was transmitted transparently through the local modem. In the event of the distant-end device not responding, the local modem will generate a response. <b>For example:</b> >0000/RET~ (indicating that it has finished waiting for a response and is now ready for further comms).
+ (ASCII Code 43)	This character warns the user that the command was accepted, but that other parameters were additionally changed.
^ (ASCII Code 94)	This code indicates that the modem is in Remote mode, so serial remote control is not possible. There are two exceptions to this: <ol style="list-style-type: none"> <li>1. The <b>LRS</b> (Local/Remote Status) command is still active, and may be used to change the operating mode to local or to serial remote control.</li> <li>2. For the CDM/R-570AL, the <b>FPL</b> (Front Panel Lockout) command is active, and may be used to configure the Front Panel Lockout to be "No lockout" or "Active."</li> </ol>

---

#### 8.4.1.6 Optional Message Arguments

Arguments are not required for all messages.

Comma ',' (ASCII Code 44), period '.' (ASCII Code 46), the numbers '0' to '9' (ASCII Codes 48 to 57), and the uppercase alphabetic characters 'A' to 'Z' (ASCII Codes 65 to 90) may be used.

---

#### 8.4.1.7 End of Packet

Controller-to-Target	This is the 'Carriage Return' ([CR]) character (ASCII code 13).
Target-to-Controller	This is the two-character sequence 'Carriage Return', 'Line Feed' ([cr][lf]) (ASCII codes 13 and 10). Both indicate the valid termination of a packet.



## 8.5 Remote Commands and Queries

### 8.5.1 Table Indexes

#### Notes:

1. The remote commands and queries are arranged as subsections of this chapter as follows:

- Sect. 8.5.2 Transmit (Tx) Commands and Queries
- Sect. 8.5.3 Receive (Rx) Commands and Queries
- Sect. 8.5.4 Unit Parameter Commands and Queries
- Sect. 8.5.5 Bulk Configuration Commands and Queries
- Sect. 8.5.6 Modem Information Commands and Queries
- Sect. 8.5.7 Modem Performance Commands and Queries
- Sect. 8.5.8 BUC (L-Band Block Up Converter) Commands and Queries (CDM/R-570AL ONLY)
- Sect. 8.5.9 LNB (L-Band Low-noise Block Down Converter) Commands and Queries (CDM/R-570AL ONLY)

Commands/queries that are unique either to a specific unit (CDM-570A 70/140 MHz versus CDM/R-570AL L-Band modems) or to a specific mode of operation ('CDM-570 Compatible Mode (CMO=0)' versus 'CDM-570A Compatible Mode (CMO=1)') are noted accordingly (e.g., "CDM-570A ONLY", "CDM/R-570AL ONLY", "Valid only in CDM-570A Compatible Mode (CMO=1)" etc.).

2. Typical for Sections 8.5.2 through 8.5.9, as per Section 8.4.1.5, the following codes are used in the 'Response to Command' column:

- = Command OK.
- ? Command accepted, but invalid arguments found.
- ! Invalid command/query.
- \* Command accepted, but not permitted in current mode.
- # Command accepted, but unit is not in **Remote** mode.
- ~ Time out of an EDMAC pass-through message.
- ^ (For any command/query other than LRS or FPL) Unit is in **Remote** Mode – no serial remote control is possible.
- + Warning: Command accepted, but other parameters were additionally changed.

3. Typical for the Section 8.5.1 tabulation index notes:

- **Where Column 'C'** = Command, and **Column 'Q'** = Query: Columns marked '**X**' designate the instruction code as *Command only, Query only, or Command or Query*.
- **Where CODE = XXX**, this indicates that the item is a **priority** command/query.
- **Where CODE =XXX<sup>AL</sup>**, this indicates that the item is specific to CDM/R-570AL L-Band operation.

The tabulation indices for Sections 8.5.2 through 8.5.9 are as follows:

### Sect. 8.5.2 Transmit (Tx) Parameter Commands and Queries:

CODE	C	Q	PAGE
APP	X	X	8-16
AUP	X	X	8-16
FRM	X	X	8-10
ITF	X	X	8-10
PLI	—	X	8-17

CODE	C	Q	PAGE
REB	—	X	8-17
TCI	X	X	8-17
TCK	X	X	8-17
TCR	X	X	8-12
TDI	X	X	8-14

CODE	C	Q	PAGE
TDR	X	X	8-14
TFO	X	X	8-14
TFT	X	X	8-11
TMD	X	X	8-11
TPL	X	X	8-15

CODE	C	Q	PAGE
TSC	X	X	8-15
TSI	X	X	8-14
TSR	X	X	8-14
TTF	—	X	8-17
TXA	X	X	8-15

CODE	C	Q	PAGE
TXO	X	X	8-15

### Sect. 8.5.3 Receive (Rx) Parameter Commands and Queries:

CODE	C	Q	PAGE
RBS	X	X	8-23
RCB	X	X	8-23
RCI	X	—	8-21

CODE	C	Q	PAGE
RCR	X	X	8-19
RDI	X	X	8-21
RDR	X	X	8-21

CODE	C	Q	PAGE
RDS	X	X	8-22
RFQ	X	X	8-49
RFT	X	X	8-18

CODE	C	Q	PAGE
RMD	X	X	8-18
RSI	X	X	8-21
RSR	—	X	8-21

CODE	C	Q	PAGE
RSW	X	X	8-22
RXA	X	X	8-22
TRF	—	X	8-23

### Sect. 8.5.4 Unit Parameter Commands and Queries

CODE	C	Q	PAGE
ACM	X	X	8-36
ADJ	X	X	8-26
ASW	X	X	8-30
BKE	X	—	8-35
BRE	—	X	8-35
BRM	X	—	8-35
BRR	—	X	8-36
BRX	X	X	8-34
BTX	X	X	8-34
CAE	X	—	8-28
CAI	X	X	8-37

CODE	C	Q	PAGE
CAS	X	—	8-29
CCF	X	X	8-33
CEX	X	X	8-34
CID	X	X	8-24
CLD	X	—	8-36
CMO	X	X	8-24
CNM	X	X	8-32
CSD	X	X	8-33
CST	X	—	8-37
CTD	X	X	8-26
DAY	X	X	8-25

CODE	C	Q	PAGE
DMM	X	X	8-37
EFM	X	X	8-25
ERF	X	X	8-26
ESA	X	X	8-25
FPL	X	X	8-24
FRB	X	—	8-37
FSW	X	—	8-30
IEP	X	—	8-28
IMG	X	X	8-24
IPA	X	X	8-31
IPG	X	X	8-31

CODE	C	Q	PAGE
ISP	X	—	8-29
LAT	X	X	8-37
LBO	X	X	8-34
LNG	X	X	8-37
LRS	X	X	8-24
MAC	—	X	8-31
MSG	X	X	8-38
MSK	X	X	8-27
NUE	—	X	8-27
NUS	—	X	8-29
ODU	X	X	8-31

CODE	C	Q	PAGE
PHN	X	X	8-37
RBP	X	X	8-35
RNE	—	X	8-28
RNS	—	X	8-29
RTS	X	X	8-32
SSI	X	X	8-29
TBP	X	X	8-35
TIM	X	X	8-25
TST	X	X	8-27
WUD	X	X	8-26

### Sect. 8.5.5 Bulk Configuration Commands and Queries

CODE	C	Q	PAGE
MGC <sup>A</sup>	X	X	8-39

CODE	C	Q	PAGE
MGC	X	X	8-41

CODE	C	Q	PAGE
OGC	X	X	8-39

### Sect. 8.5.6 Modem Information Commands and Queries

CODE	C	Q	PAGE
EID <sup>A</sup>	—	X	8-43
EID	—	X	8-46

CODE	C	Q	PAGE
FCC	—	X	8-48
FCF	—	X	8-48

CODE	C	Q	PAGE
FRW	—	X	8-47
SNO	—	X	8-47

CODE	C	Q	PAGE
SWR	—	X	8-47

### Sect. 8.5.7 Modem Performance Information Commands and Queries

CODE	C	Q	PAGE
ABE	—	X	8-55
ABR	X	—	8-55
AFE	—	X	8-55
AFR	X	—	8-55
AHS	X	X	8-57

CODE	C	Q	PAGE
APC	X	—	8-55
APL	X	X	8-57
APS	—	X	8-56
BER	—	X	8-49
BFS	—	X	8-49

CODE	C	Q	PAGE
CDM	—	X	8-54
CFE	—	X	8-54
CPR	—	X	8-54
CRM	—	X	8-53
EBN	—	X	8-50

CODE	C	Q	PAGE
FLT	—	X	8-51
OUS	—	X	8-50
PSD	—	X	8-54
RED	—	X	8-50
RFO	—	X	8-49

CODE	C	Q	PAGE
RSL	—	X	8-49
RSN	—	X	8-50
SNR	—	X	8-50
TMP	—	X	8-50

### Sect. 8.5.8 BUC (L-Band Block Up Converter) Commands and Queries (CDM/R-570AL ONLY)

CODE	C	Q	PAGE
ABA	X	X	8-58
BAD	X	X	8-58
BCE	X	X	8-58

CODE	C	Q	PAGE
BCH	X	X	8-58
BCL	X	X	8-58
BDC	—	X	8-58

CODE	C	Q	PAGE
BDV	—	X	8-58
BFR	X	X	8-59
BLO	X	X	8-59

CODE	C	Q	PAGE
BOE	X	X	8-59
BOL	—	X	8-59
BPA	—	X	8-59

CODE	C	Q	PAGE
BPC	X	X	8-59
BSV	—	X	8-60
BUT	—	X	8-60

### Sect. 8.5.9 LNB (L-Band Low-noise Block Down Converter) Commands and Queries (CDM/R-570AL ONLY)

CODE	C	Q	PAGE
ALA	X	X	8-61
LCH	X	X	8-61

CODE	C	Q	PAGE
LCL	X	X	8-61
LDC	—	X	8-61

CODE	C	Q	PAGE
LDV	—	X	8-61
LFV	X	X	8-61

CODE	C	Q	PAGE
LLO	X	X	8-62
LPC	X	X	8-62

## 8.5.2 Transmit (Tx) Parameter Commands and Queries

**Tx Priority System** = ITF (Highest priority), FRM, TFT, TMD, TCR, TDR, and TSR (Lowest Priority), indicated by **shading**. Any change to a higher priority parameter will override any of the lower priority parameters.

Parameter Type	Command (Instruction Code and Qualifier)	Arguments for Command or Response to Query	Description of Arguments	Response to Command	Query (Instruction Code and Qualifier)	Response to Query
Unit Interface Type	ITF=	1 byte, value of 0 thru 8	<p>Command or Query.</p> <p>Sets or returns Terrestrial interface type in the form x, where:</p> <ul style="list-style-type: none"> <li>0=EIA-422/EIA530 DCE</li> <li>1=V.35 DCE</li> <li>2=EIA-232 (sync).</li> <li>3= G.703 T1 AMI (forces Rx and Tx data rates to 1544 kbps)</li> <li>4= G.703 T1 B8ZS (forces Rx and Tx data rates to 1544 kbps)</li> <li>5= G.703 E1 Unbal AMI (forces Rx and Tx rates to 2048 kbps)</li> <li>6= G.703 E1 Unbal HDB3 (forces Rx and Tx rates to 2048 kbps)</li> <li>7= G.703 E1 Bal AMI (forces Rx and Tx rates to 2048 kbps)</li> <li>8= G.703 E1 Bal HDB3 (forces Rx and Tx rates to 2048 kbps)</li> <li>9 = IP Interface</li> <li>A = IP-ACM (valid only in CDM-570A Compatibility Mode (CMO=1))</li> <li>B = VersaFEC-2 ACM (requires VFEC-2 option card)</li> </ul> <p>Example: &lt;0/ITF=2 (V.35)</p> <p>Note: When ITF is set as G.703, Clock Extension Mode is automatically set as 0=None. Response=ITF+</p>	ITF= ITF? ITF* ITF# ITF+	ITF?	ITF=x (see Description of Arguments)
Unit Framing Mode	FRM=	1 byte, value of 0 or 1	<p>Command or Query.</p> <p>Sets or returns unit operating mode in the form x, where:</p> <ul style="list-style-type: none"> <li>0=Unframed</li> <li>1= EDMAC Framing</li> <li>2= EDMAC-2 Framing</li> </ul> <p>Example: &lt;0/FRM=1 (EDMAC Framing)</p>	FRM= FRM? FRM* FRM# FRM+	FRM?	FRM=x (see Description of Arguments)

Parameter Type	Command (Instruction Code and Qualifier)	Arguments for Command or Response to Query	Description of Arguments	Response to Command	Query (Instruction Code and Qualifier)	Response to Query
Tx FEC Type	TFT=	1 byte, value of 0 thru 9, A to B	<p>Command or Query.</p> <p>Sets or returns Tx FEC coding type in the form x, where:</p> <ul style="list-style-type: none"> <li>0 = None (uncoded – no FEC) (forces TCR=7 Rate 1/1) with differential encoding ON</li> <li>1 = Viterbi</li> <li>2 = Viterbi + Reed-Solomon</li> <li>3 = Reserved – do not use</li> <li>4 = Reserved – do not use</li> <li>5 = TCM + Reed-Solomon (Forces TCR=3 Rate 2/3)</li> <li>6 = Turbo</li> <li>7 = Reserved</li> <li>8 = VersaFEC CCM or ACM (fixed in IP-ACM) (see note)</li> <li>9 = VersaFEC ULL (see note)</li> <li>A = VersaFEC-2 Long (see note)</li> <li>B = VersaFEC-2 Short (see note)</li> </ul> <p>Note: Entries 8 through B are valid only in CDM-570A Compatible Mode (CMO=1). Example: &lt;0/TFT=1 (Viterbi coding)</p>	<p>TFT=</p> <p>TFT?</p> <p>TFT*</p> <p>TFT#</p> <p>TFT+</p>	TFT?	TFT=x (see Description of Arguments)
Tx Modulation Type	TMD=	1 byte, value of 0 thru 8	<p>Command or Query.</p> <p>Sets or returns Tx Modulation type in the form x, where:</p> <ul style="list-style-type: none"> <li>0 = BPSK</li> <li>1 = QPSK</li> <li>2 = OQPSK</li> <li>3 = 8PSK</li> <li>4 = 16-QAM</li> <li>5 = 8-QAM (TPC/LDPC only) (Need Codec &amp; FAST option)</li> <li>6 = 8-ARY (VersaFEC-2 only)</li> <li>7 = 16-ARY (VersaFEC-2 only)</li> <li>8 = 32-ARY (VersaFEC-2 only)</li> </ul> <p>Note: Selection availability depends on the active FEC type. Example: &lt;0/TMD=2 (OQPSK)</p>	<p>TMD=</p> <p>TMD?</p> <p>TMD*</p> <p>TMD#</p> <p>TMD+</p>	TMD?	TMD=x (see Description of Arguments)

Parameter Type	Command (Instruction Code and Qualifier)	Arguments for Command or Response to Query	Description of Arguments	Response to Command	Query (Instruction Code and Qualifier)	Response to Query
Tx FEC Code Rate	TCR=	1 byte, value of 0 thru 7, A to R, V to }	<p>Command or Query. (Query only in ACM)</p> <p>Sets or returns Tx Code Rate in the form x, where:</p> <ul style="list-style-type: none"> <li>0 = Rate 5/16 (Turbo Only)</li> <li>1 = Rate 21/44 (Turbo Only)</li> <li>2 = Rate 1/2</li> <li>3 = Rate 2/3 (8-PSK TCM or 8-QAM only)</li> <li>4 = Rate 3/4</li> <li>5 = Rate 7/8</li> <li>6 = Rate 0.95 (Turbo Only)</li> <li>7 = Rate 1/1 (Uncoded or No FEC)</li> <li>8 = Reserved</li> <li>9 = Reserved</li> </ul> <p>(The remaining entries are valid only in CDM-570A Compatible Mode (CMO=1)):</p> <ul style="list-style-type: none"> <li>A = VersaFEC CCM – BPSK Rate 0.488</li> <li>B = VersaFEC CCM – QPSK Rate 0.533</li> <li>C = VersaFEC CCM – QPSK Rate 0.631</li> <li>D = VersaFEC CCM – QPSK Rate 0.706</li> <li>E = VersaFEC CCM – QPSK Rate 0.0803</li> <li>F = VersaFEC CCM – 8-QAM Rate 0.576</li> <li>G = VersaFEC CCM – 8-QAM Rate 0.642</li> <li>H = VersaFEC CCM – 8-QAM Rate 0.711</li> <li>I = VersaFEC CCM – 8-QAM Rate 0.780</li> <li>J = VersaFEC CCM – 16-QAM Rate 0.644</li> <li>K = VersaFEC CCM – 16-QAM Rate 0.731</li> <li>L = VersaFEC CCM – 16-QAM Rate 0.780</li> <li>M = VersaFEC CCM – 16-QAM Rate 0.829</li> <li>N = VersaFEC CCM – 16-QAM Rate 0.853</li> <li>O = VersaFEC CCM ULL– BPSK Rate 0.493</li> <li>P = VersaFEC CCM ULL– QPSK Rate 0.493</li> <li>Q = VersaFEC CCM ULL– QPSK Rate 0.654</li> <li>R = VersaFEC CCM ULL– QPSK Rate 0.734</li> <li>S = Reserved</li> <li>T = Reserved</li> <li>U = Reserved</li> <li>V = VersaFEC-2 ModCod 0 – BPSK 0.489</li> <li>W = VersaFEC-2 ModCod 1 – QPSK 0.489</li> <li>X = VersaFEC-2 ModCod 2 – QPSK 0.537</li> </ul>	TCR= TCR? TRC* TRC# TRC+	TCR?	TCR=x (see Description of Arguments)

Parameter Type	Command (Instruction Code and Qualifier)	Arguments for Command or Response to Query	Description of Arguments	Response to Command	Query (Instruction Code and Qualifier)	Response to Query
Tx FEC Code Rate (continued)			<p>Y = VersaFEC-2 ModCod 3 – QPSK 0.586  Z = VersaFEC-2 ModCod 4 – QPSK 0.611  a = VersaFEC-2 ModCod 5 – QPSK 0.635  b = VersaFEC-2 ModCod 6 – QPSK 0.660  c = VersaFEC-2 ModCod 7 – QPSK 0.684  d = VersaFEC-2 ModCod 8 – QPSK 0.733  e = VersaFEC-2 ModCod 9 – 8-ARY 0.521  f = VersaFEC-2 ModCod 10 – 8-ARY 0.537  g = VersaFEC-2 ModCod 11 – 8-ARY 0.562  h = VersaFEC-2 ModCod 12 – 8-ARY 0.586  l = VersaFEC-2 ModCod 13 – 8-ARY 0.611  j = VersaFEC-2 ModCod 14 – 8-ARY 0.635  k = VersaFEC-2 ModCod 15 – 8-ARY 0.660  l = VersaFEC-2 ModCod 16 – 8-ARY 0.684  m = VersaFEC-2 ModCod 17 – 8-ARY 0.708  n = VersaFEC-2 ModCod 18 – 8-ARY 0.733  o = VersaFEC-2 ModCod 19 – 16-ARY 0.586  p = VersaFEC-2 ModCod 20 – 16-ARY 0.611  q = VersaFEC-2 ModCod 21 – 16-ARY 0.635  r = VersaFEC-2 ModCod 22 – 16-ARY 0.660  s = VersaFEC-2 ModCod 23 – 16-ARY 0.684  t = VersaFEC-2 ModCod 24 – 16-ARY 0.708  u = VersaFEC-2 ModCod 25 – 16-ARY 0.733  v = VersaFEC-2 ModCod 26 – 16-ARY 0.757  w = VersaFEC-2 ModCod 27 – 16-ARY 0.782  x = VersaFEC-2 ModCod 28 – 32-ARY 0.660  y = VersaFEC-2 ModCod 29 – 32-ARY 0.684  z = VersaFEC-2 ModCod 30 – 32-ARY 0.708  " = VersaFEC-2 ModCod 31 – 32-ARY 0.733  &amp; = VersaFEC-2 ModCod 32 – 32-ARY 0.757  @ = VersaFEC-2 ModCod 33 – 32-ARY 0.782  [ = VersaFEC-2 ModCod 34 – 32-ARY 0.801  ] = VersaFEC-2 ModCod 35 – 32-ARY 0.831  { = VersaFEC-2 ModCod 36 – 32-ARY 0.855 (Long Block only)  } = VersaFEC-2 ModCod 37 – 32-ARY 0.879 (Long Block only)</p> <p>Note: Selection availability depends on the active FEC and Modulation type.  Example: &lt;0/TCR=4 (Rate 3/4)</p>			

Parameter Type	Command (Instruction Code and Qualifier)	Arguments for Command or Response to Query	Description of Arguments	Response to Command	Query (Instruction Code and Qualifier)	Response to Query
Tx Data Rate	TDR=	CDM-570A Compatible Mode: 9 bytes CDM-570 Compatible Mode: 8 bytes	Command or Query. (Query only in ACM) Sets or returns Tx Data rate in the form xxxxx.xxx, where: xxxxx.xxx = value from 2.4 kbps to 10240 kbps Resolution = 1 bps. Examples: 1) <0/TDR=02047.999 (2047.999 kbps in CDM-570A Compatible Mode) 2) <0/TDR=2047.999 (2047.999 kbps in CDM-570 Compatible Mode)	TDR= TDR? TDR* TDR#	TDR?	TDR=xxxxx.xxx (see Description of Arguments)
Tx Symbol Rate	TSR=	8 bytes	Query only. (Command or Query in VersaFEC ACM (IP-ACM) or VersaFEC-2 ACM) Sets or returns Tx Symbol rate in the form xxxx.xxx, where: xxxx.xxx = ksymbols/sec, from 4.8 ksps to 3.00 Msps Resolution = 1 sps. Note: Symbol Rate ranges in IP-ACM from 37ksps to 3000ksps Example: <0/TSR=2047.999 (2047.999 ksymbols/sec)	TSR= TSR? TSR* TSR#	TSR?	TSR=xxxx.xxx (see Description of Arguments)
Tx Frequency	TFQ=	9 bytes	Command or Query. Sets or returns Tx Frequency in the form xxxx.xxxx, where: For CDM/R-570AL – 950 to 2250 MHz in CDM-570A Compatible Mode (CMO=1) and 950 to 2000 MHz in CDM-570 Compatible Mode (CMO=0) For CDM-570A – 50 to 90 and 100 - 180 MHz Resolution=100 Hz Examples: 1) <0/TFQ=0950.9872 2) <0/TFQ=0073.4528	TFQ= TFQ? TFQ* TFQ#	TFQ?	TFQ=xxxx.xxxx (see Description of Arguments)
Tx Data Invert	TDI=	1 byte, value 0 or 1	Command or Query. Sets or returns Invert Transmit Data in the form x, where: 0=Normal 1=Inverted Example: <0/TDI=1 (selects Inverted TX Data)	TDI= TDI? TDI* TDI#	TDI?	TDI=x (see Description of Arguments)
Tx Spectrum Invert	TSI=	1 byte, value of 0 or 1	Command or Query. Sets or returns Tx Spectrum Invert selection in the form x, where: 0=Normal, 1=Tx Spectrum Inverted Example: <0/TSI=0 (normal)	TSI= TSI? TSI* TSI#	TSI?	TSI=x (see Description of Arguments)



Parameter Type	Command (Instruction Code and Qualifier)	Arguments for Command or Response to Query	Description of Arguments	Response to Command	Query (Instruction Code and Qualifier)	Response to Query
Tx Scrambler	TSC=	1 byte, value of 0, 1 or 2	Command or Query. Sets or returns Tx Scrambler state in the form x, where: 0=Off 1=On (default scrambler type) 2 = On – IESS-315 <b>Note:</b> When CnC mode is ON, Tx Scrambler state is fixed as IESS-315. <b>Example:</b> <0/TSC=1 (Scrambler On)	TSC= TSC? TSC* TSC#	TSC?	TSC=x (see Description of Arguments)
Tx Power Level	TPL=	4 bytes	Command or Query. Sets or returns Tx Output power level in the form xx.x, where: <b>For CDM/R-570AL</b> – 0 to –40 dBm (minus sign assumed). <b>For CDM-570A</b> – 0 to –25 dBm (minus sign assumed). <b>Example:</b> <0/TPL=13.4 <b>Notes:</b> 1) In AUPC mode, command is not valid. Response= TPL*. 2) When APC is active, Response = TPL=99.9.	TPL= TPL? TPL* TPL#	TPL?	TPL=xx.x (see Description of Arguments)
Tx Carrier State	TXO=	1 byte, value 0 thru 9	Command or Query. Sets or returns Tx Carrier State in the form xx.x, where: 0 = OFF due to front panel or remote command 1 = ON 2 = RTI (receive/transmit inhibit) 3 = OFF due to ext H/W Tx Carrier Off command (not a valid argument when used as a command) 4 = OFF due to BUC warm up delay (not a valid argument in a command format.) 6 = RTI (receive/transmit inhibit), timeout = 1 second 7 = RTI (receive/transmit inhibit), timeout = 2 seconds 8 = RTI (receive/transmit inhibit), timeout = 4 seconds 9 = RTI (receive/transmit inhibit), timeout = 7 seconds <b>Example:</b> <0/TXO=1 (Tx Carrier ON)	TXO= TXO? TXO* TXO#	TXO?	TXO=x (see Description of Arguments)
Tx Alpha	TXA=	1 byte, value 0 thru 5	Command or Query. <b>Valid only in CDM-570A Compatible Mode (CMO=1).</b> Sets or returns Tx Filter Rolloff Factor in the form x, where: 0 = 0.35 1 = 0.25 2 = 0.20 3 = 0.15 4 = 0.10 5 = 0.05 <b>Example:</b> <0/TXA=0 (Tx filter rolloff factor is 0.35)	TXA= TXA? TXA#	TXA?	TXA=x (see Description of Arguments)

Parameter Type	Command (Instruction Code and Qualifier)	Arguments for Command or Response to Query	Description of Arguments	Response to Command	Query (Instruction Code and Qualifier)	Response to Query
Power Level Mode	AUP=	1 byte, value of 0, 1, 2	<p>Command or Query.</p> <p>Sets or returns Power level mode in the form x, where:</p> <ul style="list-style-type: none"> <li>0 = MANUAL mode (Normal power mode)</li> <li>1 = AUPC enabled.</li> <li>2 = CnC APC enabled</li> </ul> <p><b>Notes:</b></p> <ol style="list-style-type: none"> <li>1. EDMAC framing and/or IP-ACM must be selected for the AUPC feature to work.</li> <li>2. CnC APC will be forced to enable when CnC is in APC mode (CNM=2 .9)</li> </ol> <p><b>Example:</b> &lt;0/AUP=1</p>	AUP= AUP? AUP* AUP#	AUP?	AUP=x (see Description of Arguments)
AUPC Parameters	APP=	6 bytes	<p>Command or Query.</p> <p><b>Not valid in Manual mode.</b></p> <p>Sets or returns AUPC operating parameters, in the form abc.cd, where:</p> <ul style="list-style-type: none"> <li>a = Defines action on max. power condition. <ul style="list-style-type: none"> <li>0 = do nothing</li> <li>1 = generate Tx alarm</li> </ul> </li> <li>b = Defines action on remote demod unlock. <ul style="list-style-type: none"> <li>0 = go to nominal power</li> <li>1 = go to max power</li> </ul> </li> <li>c = Target <math>E_b/N_0</math> value, for remote demod, from 0.0 to 14.9 dB, where numbers &gt;9.9 use hex representation for the 1 st character, i.e., 14.9 is coded as E.9.</li> <li>d = Max increase in Tx Power permitted, from 0 to 9 dB</li> </ul> <p><b>Example:</b> &lt;0/APP=015.67 (Sets no alarm, max power, 5.6 dB Target and 7 dB power increase.)</p> <p><b>In IP-ACM mode:</b></p> <ul style="list-style-type: none"> <li>a=Defines action on max. power condition. <ul style="list-style-type: none"> <li>0 = do nothing</li> <li>1 = generate Tx alarm</li> <li>2=generate Tx alarm when mimimum ModCod is reached</li> </ul> </li> <li>b=Defines action on remote demod unlock. <ul style="list-style-type: none"> <li>0 = go to nominal power</li> <li>1 = go to max power</li> <li>2=hold</li> </ul> </li> <li>c = Max increase in Tx Power permitted, from 0.0 to 9.9 dB OR when CnC mode is on, from 0.0 to 3.0 dB</li> <li>d = unsued (always 0)</li> </ul>	APP= APP? APP* APP#	APP?	APP=abc.cd (see Description of Arguments)

Parameter Type	Command (Instruction Code and Qualifier)	Arguments for Command or Response to Query	Description of Arguments	Response to Command	Query (Instruction Code and Qualifier)	Response to Query
Remote Eb/No	N/A	4 bytes	Query only. Returns the value of Eb/No of the remote demod in the form xx.x, where: xx.x = 02.0 to 16.0 Response is 99.9 if remote demod unlocked. Response is xx.x if EDMAC is disabled. <b>Example:</b> <0/REB? >0/REB=12.4 <b>Note:</b> For values >16.0 dB, the response = 16.0	N/A	REB?	REB=xx.x (see Description of Arguments)
Tx Power Level Increase	N/A	3 bytes	Query only. Returns the increase in Tx power level, in dB (from the nominal setting) due to the action of AUPC. Range is 0.0 to 9.9 dB <b>Example:</b> <0/PLI? >0/PLI=2.3 <b>Note:</b> Response is ds x.x if AUPC is disabled.	N/A	PLI?	PLI=x.x (see Description of Arguments)
Tx Clock Source	TCK=	1 byte, value of 0, 1, or 2	Command or Query. Sets or returns Tx Clock Source in the form x, where: 0 = Internal 1 = Tx Terrestrial 2 = Loop-Timed <b>Note:</b> When TCK is changed from Internal to Non-Internal, Clock Extension Mode automatically changes to 0=None if it was 1=TxLock. Reply: TCK+ <b>Example:</b> <0/TCK=0 (selects Internal)	TCK= TCK? TCK* TCK#	TCK?	TCK=x (see Description of Arguments)
Tx Clock Invert	TCI=	1 byte, value 0 or 1	Command or Query. Sets or returns Invert Transmit Data Clock in the form x, where: 0 = Normal 1 = Invert	TCI= TCI? TCI* TCI#	TCI?	TCI=x (see Description of Arguments)
Terminal Tx Frequency	N/A	10 bytes	Query only – CDM/R-570AL only. Returns Terminal Tx Frequency in the form xxxxx.xxxx, where: xxxxx.xxxx = frequency (BUC LO ± TFQ) Resolution = 100 Hz Returns 00000.0000 if LNB LO is zero <b>Example:</b> <0/TTF? >0/TTF=14250.9872	N/A	TTF?	TTF=xxxxx.xxxx (see Description of Arguments)

### 8.5.3 Receive (Rx) Parameter Commands and Queries

**Rx Priority System** = RFT (Highest priority), RMD, RCR, RDR, and RSR (Lowest Priority), indicated by **shading**. Any change to a higher priority parameter will override any of the lower priority parameters.

Parameter Type	Command (Instruction Code and Qualifier)	Arguments for Command or Response to Query	Description of Arguments	Response to Command	Query (Instruction Code and Qualifier)	Response to Query
Rx FEC Type	RFT=	1 byte, value of 0 thru 9, A and B	<p>Command or Query. (Query only in ACM) Sets or returns Rx FEC Type in the form x, where:</p> <ul style="list-style-type: none"> <li>0 = None (uncoded – no FEC) with differential encoding ON</li> <li>1 = Viterbi</li> <li>2 = Viterbi + Reed-Solomon</li> <li>3 = Reserved – do not use</li> <li>4 = Reserved – do not use</li> <li>5 = TCM + Reed-Solomon</li> <li>6 = Turbo</li> <li>7 = Reserved</li> <li>8 = VersaFEC CCM or ACM (fixed in IP-ACM) (see note)</li> <li>9 = VersaFEC ULL (see note)</li> <li>A = VersaFEC-2 Long</li> <li>B = VersaFEC-2 Short</li> </ul> <p>Note: Entries 8 through B are valid only in CDM-570A Compatible Mode (CMO=1). Example: &lt;0/RFT=1 (Viterbi only)</p>	RFT= RFT? RFT* RFT# RFT+	RFT?	RFT=x (same format as command argument)
Rx Demod type	RMD=	1 byte, value of 0 thru 8	<p>Command or Query. Sets or returns Rx Demodulation in the form x, where:</p> <ul style="list-style-type: none"> <li>0 = BPSK</li> <li>1 = QPSK</li> <li>2 = OQPSK</li> <li>3 = 8PSK</li> <li>4 = 16QAM</li> <li>5 = 8-QAM (TPC/LDPC only) (Need Codec &amp; FAST option)</li> <li>6 = 8-ARY (VersaFEC-2 only)</li> <li>7 = 16-ARY (VersaFEC-2 only)</li> <li>8 = 32-ARY (VersaFEC-2 only)</li> </ul> <p>Note: Selection availability depends on the active FEC type. Example: &lt;0/RMD=2 (OQPSK)</p>	RMD= RMD? RMD* RMD# RMD+	RMD?	RMD=x (see Description of Arguments)

Parameter Type	Command (Instruction Code and Qualifier)	Arguments for Command or Response to Query	Description of Arguments	Response to Command	Query (Instruction Code and Qualifier)	Response to Query
Rx FEC Code Rate	RCR=	1 byte, value of 0 thru 7, A to R, V to }	<p>Command or Query. (Query only in ACM)</p> <p>Sets or returns Rx FEC Code Rate in the form x, where:</p> <ul style="list-style-type: none"> <li>0 = Rate 5/16 (Turbo Only)</li> <li>1 = Rate 21/44 (Turbo Only)</li> <li>2 = Rate 1/2</li> <li>3 = Rate 2/3 (8-PSK TCM or 8-QAM only)</li> <li>4 = Rate 3/4</li> <li>5 = Rate 7/8</li> <li>6 = Rate 0.95 (Turbo Only)</li> <li>7 = Rate 1/1 (Uncoded or No FEC)</li> <li>8 = Reserved</li> <li>9 = Reserved</li> </ul> <p>The remaining entries are valid only in CDM-570A Compatible Mode (CMO=1):</p> <ul style="list-style-type: none"> <li>A = VersaFEC CCM – BPSK Rate 0.488</li> <li>B = VersaFEC CCM – QPSK Rate 0.533</li> <li>C = VersaFEC CCM – QPSK Rate 0.631</li> <li>D = VersaFEC CCM – QPSK Rate 0.706</li> <li>E = VersaFEC CCM – QPSK Rate 0.0803</li> <li>F = VersaFEC CCM – 8-QAM Rate 0.576</li> <li>G = VersaFEC CCM – 8-QAM Rate 0.642</li> <li>H = VersaFEC CCM – 8-QAM Rate 0.711</li> <li>I = VersaFEC CCM – 8-QAM Rate 0.780</li> <li>J = VersaFEC CCM – 16-QAM Rate 0.644</li> <li>K = VersaFEC CCM – 16-QAM Rate 0.731</li> <li>L = VersaFEC CCM – 16-QAM Rate 0.780</li> <li>M = VersaFEC CCM – 16-QAM Rate 0.829</li> <li>N = VersaFEC CCM – 16-QAM Rate 0.853</li> <li>O = VersaFEC CCM ULL– BPSK Rate 0.493</li> <li>P = VersaFEC CCM ULL– QPSK Rate 0.493</li> <li>Q = VersaFEC CCM ULL– QPSK Rate 0.654</li> <li>R = VersaFEC CCM ULL– QPSK Rate 0.734</li> <li>S = Reserved</li> <li>T = Reserved</li> <li>U = Reserved</li> <li>V = VersaFEC-2 ModCod 0 – BPSK 0.489</li> <li>W = VersaFEC-2 ModCod 1 – QPSK 0.489</li> </ul>	RCR= RCR? RCR* RCR# RCR+	RCR?	RCR=x (see Description of Arguments)

Parameter Type	Command (Instruction Code and Qualifier)	Arguments for Command or Response to Query	Description of Arguments	Response to Command	Query (Instruction Code and Qualifier)	Response to Query
Rx FEC Code Rate (continued)			<p>X = VersaFEC-2 ModCod 2 – QPSK 0.537            Y = VersaFEC-2 ModCod 3 – QPSK 0.586            Z = VersaFEC-2 ModCod 4 – QPSK 0.611            a = VersaFEC-2 ModCod 5 – QPSK 0.635            b = VersaFEC-2 ModCod 6 – QPSK 0.660            c = VersaFEC-2 ModCod 7 – QPSK 0.684            d = VersaFEC-2 ModCod 8 – QPSK 0.733            e = VersaFEC-2 ModCod 9 – 8-ARY 0.521            f = VersaFEC-2 ModCod 10 – 8-ARY 0.537            g = VersaFEC-2 ModCod 11 – 8-ARY 0.562            h = VersaFEC-2 ModCod 12 – 8-ARY 0.586            I = VersaFEC-2 ModCod 13 – 8-ARY 0.611            j = VersaFEC-2 ModCod 14 – 8-ARY 0.635            k = VersaFEC-2 ModCod 15 – 8-ARY 0.660            l = VersaFEC-2 ModCod 16 – 8-ARY 0.684            m = VersaFEC-2 ModCod 17 – 8-ARY 0.708            n = VersaFEC-2 ModCod 18 – 8-ARY 0.733            o = VersaFEC-2 ModCod 19 – 16-ARY 0.586            p = VersaFEC-2 ModCod 20 – 16-ARY 0.611            q = VersaFEC-2 ModCod 21 – 16-ARY 0.635            r = VersaFEC-2 ModCod 22 – 16-ARY 0.660            s = VersaFEC-2 ModCod 23 – 16-ARY 0.684            t = VersaFEC-2 ModCod 24 – 16-ARY 0.708            u = VersaFEC-2 ModCod 25 – 16-ARY 0.733            v = VersaFEC-2 ModCod 26 – 16-ARY 0.757            w = VersaFEC-2 ModCod 27 – 16-ARY 0.782            x = VersaFEC-2 ModCod 28 – 32-ARY 0.660            y = VersaFEC-2 ModCod 29 – 32-ARY 0.684            z = VersaFEC-2 ModCod 30 – 32-ARY 0.708            “ = VersaFEC-2 ModCod 31 – 32-ARY 0.733            &amp; = VersaFEC-2 ModCod 32 – 32-ARY 0.757            @ = VersaFEC-2 ModCod 33 – 32-ARY 0.782            [= VersaFEC-2 ModCod 34 – 32-ARY 0.801            ] = VersaFEC-2 ModCod 35 – 32-ARY 0.831            { = VersaFEC-2 ModCod 36 – 32-ARY 0.855 (Long Block only)            } = VersaFEC-2 ModCod 37 – 32-ARY 0.879 (Long Block only)</p> <p>Note: Selection availability depends on the active FEC and demodulation type. Example: &lt;0/RCR=1 (Rate 3/4)</p>			

Parameter Type	Command (Instruction Code and Qualifier)	Arguments for Command or Response to Query	Description of Arguments	Response to Command	Query (Instruction Code and Qualifier)	Response to Query
Rx Data Rate	RDR=	9 bytes	Command or Query. (Query only in ACM) Sets or returns Rx Data Rate in the form xxxxx.xx, where: xxxxx.xx = value from 2.4 kbps to 10240 kbps Resolution = 1 bps Example: <0/RDR=2047.999	RDR= RDR? RDR* RDR#	RDR?	RDR=xxxxx.xxx (see Description of Arguments)
Rx Symbol Rate	RSR=	8 bytes	Query only. (Command or Query in VersaFEC ACM (IP-ACM) or VersaFEC2-ACM) Sets or returns Rx Symbol rate in the form xxxx.xxx, where: xxxx.xxx = value, in ksymbols/sec, from 4.8 ksps to 3.00 Msps Resolution = 1 sps. Note: Symbol Rate ranges in IP-ACM from 37ksps to 3000ksps Example: <0/RSR=2047.999 (2047.999 ksymbols/sec)	N/A	RSR?	RSR=xxxx.xxx (see Description of Arguments)
Rx Frequency	RFQ=	9 bytes	Command or Query. Sets or returns Rx Frequency in the form xxxx.xxxx, where: For CDM/R-570AL: 950 to 2250 MHz in CDM-570A Compatible Mode (CMO=1) and 950 to 2000 MHz in CDM-570 Compatible Mode (CMO=0) For CDM-570A: 50 to 90 and 100 to 180 MHz Resolution = 100 Hz Examples: 1) <0/RFQ=0950.9872 2) <0/RFQ=0073.4528	RFQ= RFQ? RFQ* RFQ#	RFQ?	RFQ=xxxx.xxxx (see Description of Arguments)
Rx Data Invert	RDI=	1 byte, 0 or 1	Command or Query. Sets or returns Invert Receive Data in the form x, where: 0 = Normal 1 = Inverted Example: <0/RDI=1 (selects Inverted RX Data)	RDI= RDI? RDI* RDI#	RDI?	RDI=x (see Description of Arguments)
Rx Spectrum Invert	RSI=	1 byte, value of 0 or 1	Command or Query. Sets or returns Rx Spectrum Invert in the form x, where: 0 = Normal 1 = Rx Spectrum Invert Example: <0/RSI=0 (selects Normal)	RSI= RSI? RSI* RSI#	RSI?	RSI=x (see Description of Arguments)
Rx Clock Invert	RCI=	1 byte, value 0 or 1	Command or Query. Sets or returns Invert Receive Clock in the form x, where: 0 = Normal 1 = Rx Spectrum Invert	RCI= RCI? RCI* RCI#	RCI?	RCI=x (see Description of Arguments)

Parameter Type	Command (Instruction Code and Qualifier)	Arguments for Command or Response to Query	Description of Arguments	Response to Command	Query (Instruction Code and Qualifier)	Response to Query
Rx Descrambler	RDS=	1 byte, value of 0, 1, or 2	Command or Query. Sets or returns Rx Descrambler state in the form x, where: 0 = Off 1 = On (default descrambler type) 2 = On – IESS-315 <b>Note:</b> When CnC mode is ON, Rx Descrambler state is fixed as IESS-315. <b>Example:</b> <0/RDS=1 (Scrambler On)	RDS= RDS? RDS* RDS#	RDS?	RDS=x (see Description of Arguments)
Rx Demod Acquisition Sweep Width	RSW=	3 bytes	Command or Query. Sets or returns Rx $\pm$ acquisition sweep range of demodulator in the form xxx, where: xxx = value, in kHz... <b>For CDM-570A</b> – From $\pm 1$ to $\pm 32$ kHz (rates < 625 ksym/second) <b>For CDM/R-570AL</b> – From $\pm 1$ to $\pm 200$ kHz (rates $\geq 625$ ksym/second) <b>Note:</b> When the modem is in CNC mode (CNM>0) and Rx Symbol Rate < 64ksps, acquisition sweep range is limited from $\pm 1$ to $\pm$ (Rx_Symbol Rate / 2) kHz <b>Example:</b> <0/RSW=009 ( $\pm 9$ kHz)	RSW= RSW? RSW* RSW#	RSW?	RSW=xxx (see Description of Arguments)
Rx Alpha	RXA=	1 byte, value of 0 or 1	Command or Query. <b>Valid only in CDM-570A Compatible Mode (CMO=1).</b> Sets or returns Rx Filter Rolloff Factor in the form x, where: 0 = 0.35 1 = 0.12 <b>Example:</b> <0/RXA=0 (0.35 Tx filter rolloff factor)	RXA= RXA? RXA#	RXA?	RXA=x (see Description of Arguments)



Parameter Type	Command (Instruction Code and Qualifier)	Arguments for Command or Response to Query	Description of Arguments	Response to Command	Query (Instruction Code and Qualifier)	Response to Query
Rx Buffer Size	RBS=	1 byte, value of 0 thru 9	Command or Query. Sets or returns Rx buffer size in the form x, where: 0 = Buffer disabled (Clock mode = Rx satellite) 1 = ±1024 bits 2 = ±2048 bits 3 = ±4096 bits 4 = ±8192 bits 5 = ±16384 bits 6 = ±32768 bits 7 = ±128 bits 8 = ±256 bits 9 = ±512 bits <b>Example:</b> <0/RBS=0	RBS= RBS? RBS* RBS#	RBS?	RBS=x (same format as command argument)
ReCenter Buffer	RCB=	None	Command only. Forces the software to recenter the receive Plesiochronous/Doppler buffer. <b>This command takes no arguments.</b> <b>Example:</b> <0/RCB=	RCB= RCB? RCB* RCB#	N/A	N/A
Terminal Rx Frequency	N/A	10 bytes	Query only – <b>CDM/R-570AL only.</b> Returns the Terminal Rx Frequency in the form xxxxx.xxxx, where: xxxxx.xxxx = frequency (LNB LO ± RFQ) Resolution = 100 Hz Returns 00000.0000 if LNB LO is zero <b>Example:</b> <0/TRF? >0/TRF=11650.2249	N/A	TRF?	TRF=xxxxx.xxxx (see Description of Arguments)

### 8.5.4 Unit Parameter Commands and Queries

Parameter Type	Command (Instruction Code and Qualifier)	Arguments for Command or Response to Query	Description of Arguments	Response to Command	Query (Instruction Code and Qualifier)	Response to Query
Compatible Mode	CMO=	1 byte, value of 0 or 1	Command or Query. Sets or returns the CDM-570/CDM-570A compatible status in the form x, where: 0 = CDM-570 Compatible Mode 1 = CDM-570A Compatible Mode <b>Example:</b> <0/CMO=1 (CDM-570A Compatible Mode)	CMO= CMO? CMO* CMO#	CMO?	CMO=x (see Description of Arguments)
Local/Remote Status	LRS=	1 byte, value of 0, 1 or 3	Command or Query. Sets or returns Local/Remote status in the form x, where: 0 = Local 1 = Serial Remote 3 = Ethernet Remote <b>Example:</b> <0/LRS=1 (Serial Remote)	LRS= LRS? LRS* LRS# LRS+	LRS?	LRS=x (see Description of Arguments)
Front Panel Lockout	FPL=	1 byte, value of 0 or 1	Command or Query. Sets or returns the front panel lockout state in the form x, where: 0 = no lockout 1 = front panel lockout active Disable the lockout by either FPL=0, or by setting into local mode using LRS=0 (response is LRS+ meaning FPL is disabled at the same time) <b>Note:</b> When using the Optional Packet Processor Command Line Interface (CLI), to verify CLI lockout: <0/FPL? >0/FPL=0 (Lockout disabled) <i>or</i> >0/FPL=1 (Lockout enabled)	FPL= FPL? FPL* FPL#	FPL?	FPL=x (see Description of Arguments)
Software Image	IMG=	1 byte, value of 1 or 2	Command or Query. Sets or returns Current Active software image in the form x, where: 1 = Bulk Image # 1 currently active 2 = Bulk Image # 2 currently active <b>Example:</b> <0/IMG=1 (Image #1 active)	IMG= IMG? IMG* IMG#	IMG?	IMG=x (see Description of Arguments)
Circuit ID String	CID=	24 bytes	Command or Query. Sets or returns the user-defined Circuit ID string. <b>Note:</b> Circuit ID string is a fixed length of up to 24 characters. Valid characters include: [Space] ( ) * + - , . / 0 thru 9 and A thru Z	CID= CID? CID* CID#	CID?	CID=xxxxxxxxxxxx xxxxxxxxxxxx (see Description of Arguments)

Parameter Type	Command (Instruction Code and Qualifier)	Arguments for Command or Response to Query	Description of Arguments	Response to Command	Query (Instruction Code and Qualifier)	Response to Query
RTC Date	DAY=	6 bytes	Command or Query. Sets or returns the date in the form ddmmyy, where dd = day of the month (01 to 31), mm = month (01 to 12) yy = year (00 to 99) <b>Example:</b> <0/DAY=240457 (April 24, 2057)	DAY= DAY? DAY* DAY#	DAY?	DAY=ddmmyy (see Description of Arguments)
RTC Time	TIM=	6 bytes	Command or Query. Sets or returns the time, from midnight, in the form hhmmss, where: hh = hours (00 to 23) mm = minutes (00 to 59) ss = seconds (00 to 59) <b>Example:</b> <0/TIM=231259 (23 hours:12 minutes:59 seconds)	TIM= TIM? TIM* TIM#	TIM?	TIM=hhmmss (see Description of Arguments)
EDMAC Framing Mode	EFM=	1 byte, value of 0, 1 or 2	Command or Query. Sets or returns EDMAC mode in the form x, where: 0 = EDMAC OFF (Framing is on, AUPC active) 1 = EDMAC MASTER 2 = EDMAC SLAVE (Query Only) <b>Example:</b> <0/EFM=1 (EDMAC Enabled as Master)	EFM= EFM? EFM* EFM#	EFM?	EFM=x (see Description of Arguments)
EDMAC Slave Address Range	ESA=	4 bytes	Command or Query. <b>Valid only for an EDMAC Master.</b> Sets or returns EDMAC Slave Address Range, where: As a <b>command</b> , sets the range of addresses of distant-end units (modems or transceivers) for which this unit, as the Master, forwards messages. <b>Example:</b> <0/ESA=0090 As a <b>query</b> , it may be sent to an EDMAC slave, which responds with the appropriate address. <b>Note:</b> Only values that are integer multiples of ten are permitted. (0010, 0020, 0030, 0040, etc.).	ESA= ESA? ESA* ESA#	ESA?	ESA=xxxx (see Description of Arguments)

Parameter Type	Command (Instruction Code and Qualifier)	Arguments for Command or Response to Query	Description of Arguments	Response to Command	Query (Instruction Code and Qualifier)	Response to Query
External Reference Frequency	ERF=	1 byte, value of 0 thru 5	Command or Query. Sets or returns External Reference Frequency in the form x, where: 0 = Internal 1 = External 1 MHz 2 = External 2 MHz 3 = External 5 MHz 4 = External 10 MHz 5 = Internal 10MHz plus output (the Reference is available on the "Ext Ref" rear connector (small rear-panel LED indicates when ON)) <b>Example:</b> <0/ERF=0 (External reference not used – uses internal)	ERF= ERF? ERF * ERF #	ERF?	ERF = x (see Description of Arguments)
Internal 10MHz Reference Adjustment	ADJ=	4 bytes, numeric	Command or Query. Sets or returns fine adjustment of the modem Internal 10MHz Reference in the form sddd, where: s = sign (+ or -), and ddd = value from 000 to 999	ADJ= ADJ? ADJ* ADJ#	ADJ?	ADJ=sddd (see Description of Arguments)
Warm-up Delay	WUD=	1 byte, value 0 or 1	Command or Query. Sets or returns Warm-up Delay for internal frequency reference (OCXO) in the form x, where: 0 = Disabled (instant on – no delay for OCXO to reach temperature) 1 = Enabled (unit waits until OCXO reaches correct temperature) <b>Example:</b> <0/WUD=1 (selects Warm-up Delay)	WUD= WUD? WUD* WUD#	WUD?	WUD=x (see Description of Arguments)
Countdown	CTD=	3 bytes	Command or Query. As a <b>command</b> , only takes the argument 000. Truncates the Warm-up delay period to zero and forces the unit into 'instant-on' mode. <b>For example</b> , CTD=000 terminates the warm-up delay. As a <b>query</b> , returns the Warm-up Delay countdown, in seconds remaining. Range is from 000 to 200 seconds. <b>Example:</b> <0/CTD? >0/CTD=067 (means the unit will wait another 67 seconds before it enters its operational state)	CTD= CTD? CTD* CTD#	CTD?	CTD=xxx (see Description of Arguments)

Parameter Type	Command (Instruction Code and Qualifier)	Arguments for Command or Response to Query	Description of Arguments	Response to Command	Query (Instruction Code and Qualifier)	Response to Query
Unit Test Mode	TST=	1 byte, value of 0 thru 6	Command or Query. Sets or returns the CDM/R-570AL Test Mode, where: 0 = Normal Mode (no test) 1 = IF Loopback 2 = Digital Loopback 3 = I/O Loopback 4 = RF Loopback 5 = Tx CW 6 = Tx Alternating 1,0 Pattern <b>Example:</b> <0/TST=1 (IF Loopback)	TST= TST? TST* TST#	TST?	TST=x (see Description of Arguments)
Number of Unread stored Events	N/A	3 bytes	Query only. Returns the number, in the form xxx, of stored events which remain unread over the remote interface. <b>Example:</b> <0/NUE? >0/NUE=126	N/A	NUE?	NUE=xxx (see Description of Arguments)
Unit Alarm Mask	MSK=	12 bytes	Command or Query. Sets or returns Alarm Mask conditions in the form abcdefghijkl, where: a = Tx FIFO b = G.703 BPV c = Tx-AIS d = Rx AGC Alarm e = Eb/No Alarm f = Rx-AIS g = Buffer slip h = Ext Reference alarm i = BUC alarm j = LNB alarm k = G.703 Loss of Signal alarm (0 = unmasked, 1 = masked) l = spare <b>Notes:</b> 1) Query response of 0 (unmasked/active) or 1 (masked) is provided for each parameter. 2) For argument k, if G703 CEx FAST option is not installed or Tx clock is not Internal, only 1(masked) is allowed. <b>Example:</b> <0/MSK=1110011100	MSK= MSK? MSK* MSK#	MSK?	MSK=abcdefghijkl (see Description of Arguments)

Parameter Type	Command (Instruction Code and Qualifier)	Arguments for Command or Response to Query	Description of Arguments	Response to Command	Query (Instruction Code and Qualifier)	Response to Query
Retrieve next 5 unread Stored Events	N/A	75 bytes	<p>Query only. Returns the oldest 5 Stored Events which have not yet been read over the remote interface. Reply format: {CR}Sub-body{CR}Sub-body{CR}Sub-body{CR}Sub-body{CR}Sub-body, where Sub-body= ABCddmmyhmmss, A being the fault/clear indicator, where: F = Fault C = Clear I = Info B being the fault type, where: 1 = Unit 2 = Rx Traffic 3 = Tx Traffic 4 = ODU 5 = Power on/off, or log cleared C is Fault Code numbers, as in FLT? or Info Code, where: 0 = Power Off 1 = Power On 2 = Log Cleared 3 = Global Config Change 4 = Redundancy Config Change</p> <p><b>Notes:</b> 1) If less than 5 events are to be retrieved, the remaining positions are padded with zeros. 2) If there are no new events, the response is RNE*.</p>	N/A	RNE?	RNE={CR}ABCddmmyhmmss{CR}ABCddmmyhmmss{CR}ABCddmmyhmmss{CR}ABCddmmyhmmss{CR}ABCddmmyhmmss (see Description of Arguments)
Clear All Stored Events	CAE=	None	<p>Command only. <b>This command takes no arguments.</b> Forces the software to clear the software events log.</p>	CAE= CAE? CAE* CAE#	N/A	N/A
Initialize Events Pointer	IEP=	None	<p>Command only. <b>This command takes no arguments.</b> Resets internal pointer to allow RNE? queries to start at the beginning of the stored events log.</p>	IEP= IEP#	N/A	N/A

Parameter Type	Command (Instruction Code and Qualifier)	Arguments for Command or Response to Query	Description of Arguments	Response to Command	Query (Instruction Code and Qualifier)	Response to Query
Statistics Sample Interval	SSI=	1 byte, numerical	Command or Query. Sets or returns the sample interval for the Statistics Logging Function in the form x, where: x = 0 to 9 in 10 minute steps. <b>Note:</b> Setting this parameter to 0 disables the statistics logging function. <b>Example:</b> <0/SSI=3 (30 minutes)	SSI= SSI? SSI* SSI#	SSI?	SSI=x (see Description of Arguments)
Number of Unread stored Statistics	N/A	3 bytes	Query only. Returns the number of stored statistics that remain unread over the remote interface in the form xxx. <b>Example:</b> <0/NUS? >0/NUS=247	N/A	NUS?	NUS=xxx (see Description of Arguments)
Clear All Stored Statistics	CAS=	None	Command only. <b>This command takes no arguments.</b> Forces the software to clear the software statistics log	CAS= CAS? CAS* CAS#	N/A	N/A
Initialize Statistics Pointer	ISP=	None	Command only. <b>This command takes no arguments.</b> Resets internal pointer to allow RNS? queries to start at the beginning of the statistics log.	ISP= ISP#	N/A	N/A
Retrieve Next 5 unread stored Statistics	N/A	130 bytes	Query only. Returns the oldest 5 Stored Statistics that remain unread over the remote interface in the forms: <b>For non-IP-ACM modes:</b> {CR}Sub-body{CR}Sub-body{CR}Sub-body{CR}Subbody{CR}Sub-body where Sub-body = AA.ABB.BC.CD.Dddmmyyhhmmss: AA.A=Minimum Eb/No during sample period. BB.B=Average Eb/No during sample period. C.C=Max. Tx Power Level Increase during sample period. D.D=Average Tx Power Level Increase during sample period. ddmmyyhhmmss = date/time stamp.	N/A	RNS?	RNS={CR}AA.ABB. BC.CD.Dddmmyy hhmmss{CR}AA.AB B.BC.CD.Dddmmyy hhmmss{CR}AA.AB B.BC.CD.Dddmmyy hhmmss{CR}AA.AB B.BC.CD.Dddmmyy hhmmss{CR}AA.AB B.BC.CD.Dddmmyy hhmmss (see Description of Arguments)

Parameter Type	Command (Instruction Code and Qualifier)	Arguments for Command or Response to Query	Description of Arguments	Response to Command	Query (Instruction Code and Qualifier)	Response to Query
Retrieve Next 5 unread stored Statistics (continued)			<p><b>For IP-ACM mode:</b> {CR}Sub-body{CR}Sub-body{CR}Sub-body{CR}Subbody{CR}Sub-body where Sub-body = AA.ABB.BC,DE,Fddmmyyhhmss: AA.A=Minimum Eb/No during sample period. BB.B=Average Eb/No during sample period. C=IP-ACM Rx ModCod that was current at time the statistic entry was logged. D=Maximum Rx ModCod in hex during sample period. E=Minimum Rx ModCod in hex during sample period. ddmmyyhhmss = date/time stamp.</p> <p><b>Notes:</b> 1) If there are no new events, the unit response is RNS*. 2) If less than 5 statistics are to be retrieved, the remaining positions are padded with zeros. 3) If you change your operating mode between non-IP-ACM and IP-ACM modes, Comtech EF Data recommends that you execute the Clear All stored Statistics (CAS=) command before retrieving any further statistics.</p>			
1:1 Operational Mode	ASW=	1 byte, value of 0 or 1	<p>Command or Query. Sets or returns 1:1 operational mode in the form x, where 0 = Unit is in Manual Mode 1 = Unit is in Auto Mode</p> <p><b>Note:</b> In Manual Mode, all fault relays are forced to the non-faulted condition. This allows the online unit to be configured without an unintended switchover to the backup unit.</p>	ASW= ASW? ASW* ASW#	ASW?	ASW=x (see Description of Arguments)
Force 1:1 Switch	FSW=	None	<p>Command only. <b>This command takes no arguments.</b> Forces the unit to toggle the Unit Fail relay to the 'fail' state for approximately 500ms. If the unit is part of a 1:1 pair and it is currently the 'On Line' unit, this forces a switchover, so the unit is then be in 'Standby' mode.</p> <p><b>Notes:</b> 1) The 1:1 redundancy system must be installed. 2) Both online and offline units must be in Manual Mode for this command to function. 3) If the 1:1 redundancy system is not installed, then the command returns FSW? 4) If the unit is offline, then the command will return FSW?</p>	FSW= (message OK)	N/A	N/A



Parameter Type	Command (Instruction Code and Qualifier)	Arguments for Command or Response to Query	Description of Arguments	Response to Command	Query (Instruction Code and Qualifier)	Response to Query
Outdoor Unit Comms Enable	ODU=	1 byte, value of 0 or 1	Command or Query – <b>CDM-570A Only</b> . Enables or disables communications, via the FSK link, with a Comtech EF Data transceiver (ODU) in the form x, where: 0 = Disabled 1 = Enabled <b>Example:</b> <0/ODU=0 (ODU disabled)	ODU= ODU? ODU* ODU#	ODU?	ODU=x (see Description of Arguments)
IP Address	IPA=	18 bytes, numerical	Command or Query. Sets or returns the IP address and network prefix for the '10/100 M&C' 10/100 BaseT Ethernet management port, in the form xx.xxx.xxx.xxx.yy, where: xxx.xxx.xxx.xxx is the IP address yy is the network prefix (from 8 to 30) <b>Example:</b> <0/IPA=010.006.030.001.24	IPA= IPA? IPA* IPA#	IPA?	IPA= xxx.xxx.xxx.xxx.yy (see Description of Arguments)
IP Gateway	IPG=	15 bytes numerical	Command or Query. Sets or returns the IP Gateway Address for the Ethernet management port, in the form aaa.bbb.ccc.ddd, where permitted ranges (all zeroes are not permitted) are: aaa = 0–223 bbb = 0–255 ccc = 0–255 ddd = 0–255 <b>Example:</b> <0/IPG=010.006.030.001	IPG= IPG? IPG* IPG#	IPG?	IPG= xxx.xxx.xxx.xxx (see Description of Arguments)
MAC Address	N/A	12 bytes, Alphanumeric	Query only. Returns the unique MAC Address for the modem. <b>Example:</b> <0/MAC? >0/MAC=0006B00001C2	N/A	MAC?	MAC=aabbccdeeff (see Description of Arguments)

Parameter Type	Command (Instruction Code and Qualifier)	Arguments for Command or Response to Query	Description of Arguments	Response to Command	Query (Instruction Code and Qualifier)	Response to Query
Request to Send	RTS=	1 byte, value of 0 thru 3	<p>Command or Query.</p> <p>Sets or returns how RTS/CTS operates at the main data interface in the form x, where:</p> <ul style="list-style-type: none"> <li>0 = RTS/CTS Loop, No Action RTS and CTS are looped, so that CTS echoes the state of RTS, but RTS does not control the ON/OFF state of the carrier</li> <li>1 = Loop, RTS Controls Tx O/P RTS and CTS are looped, so that CTS echoes the state of RTS, and RTS controls the ON/OFF state of the carrier (in other words, the modem will not bring up its TX carrier until RTS is asserted.)</li> <li>2 = Ignore RTS, Assert CTS</li> <li>3 = 1:N system in use. RTS/CTS ignored (Query only) RTS is ignored, and CTS is asserted unconditionally.</li> </ul> <p><b>Example:</b> &lt;0/RTS=0 (RTS/CTS Loop, No Action).</p>	RTS= RTS? RTS* RTS#	RTS?	RTS=x (see Description of Arguments)
DoubleTalk Carrier-in-Carrier (CnC) Mode	CNM=	1 byte, value of 0 to 9	<p>Command or Query.</p> <p><b>Valid only in CDM-570A Compatible Mode (CMO=1).</b></p> <p>Sets or returns CnC Mode in the form x, where:</p> <ul style="list-style-type: none"> <li>0 = Off</li> <li>1 = On (normal)</li> <li>2 = APC, C-Band, Side A</li> <li>3 = APC, X-Band, Side A</li> <li>4 = APC, Ku-Band, Side A</li> <li>5 = APC, Ka-Band, Side A</li> <li>6 = APC, C-Band, Side B</li> <li>7 = APC, X-Band, Side B</li> <li>8 = APC, Ku-Band, Side B</li> <li>9 = APC, Ka-Band, Side B</li> </ul>	CNM= CNM? CNM* CNM#	CNM?	CNM=x (see Description of Arguments)

Parameter Type	Command (Instruction Code and Qualifier)	Arguments for Command or Response to Query	Description of Arguments	Response to Command	Query (Instruction Code and Qualifier)	Response to Query
DoubleTalk Carrier-in-Carrier (CnC) Mode (continued)			<p><b>Notes:</b></p> <ol style="list-style-type: none"> <li>CnC may be enabled only if: <ul style="list-style-type: none"> <li>The optional plug-in hardware CnC card is installed AND a CnC FAST option is unlocked.</li> <li>The range of permitted data rates is controlled by a FAST feature code. (Read EID to decode the installed options for the modem)</li> </ul> </li> <li>If CnC-APC is active (APS=22), key transmission/reception (Modulation, FEC type, Code Rate, Framing, Data Rate, Interface) cannot be modified until CnC-APC is suspended. (Use APC command to suspend or activate.)</li> <li>If CNM=2..9, AUP is forced to 3.</li> <li>Entries 1 to 9 are not valid if Tx or Rx Symbol Rate is &lt;16ksps.</li> </ol>			
CnC Frequency Range/offset	CCF=	3 bytes	<p>Command or Query.  <b>Valid only in CDM-570A Compatible Mode (CMO=1).</b>  Sets or returns the maximum value that may be entered, in the form xxx, as the CnC Sweep frequency range; depends on the Rx symbol rate as follows:  16ksps to 64ksps: ±1 to the symbol rate (ksps)/2  64ksps and above: ±1 to 32 kHz  <b>Example:</b> &lt;0/CCF=030</p>	CCF= CCF? CCF* CCF#	CCF?	CCF=xxx (see Description of Arguments)
CnC Min/Max Search Delay	CSD=	6 bytes	<p>Command or Query.  <b>Valid only in CDM-570A Compatible Mode (CMO=1).</b>  Sets or returns CnC min/max delay value in milliseconds, in the form xxxyyy, where:  xxx = minimum delay  yyy = maximum delay  Maximum allowable value is 300ms  <b>Example:</b> &lt;0/CSD=010225</p>	CSD= CSD? CSD* CSD#	CSD?	CSD=xxxxyy (see Description of Arguments)

Parameter Type	Command (Instruction Code and Qualifier)	Arguments for Command or Response to Query	Description of Arguments	Response to Command	Query (Instruction Code and Qualifier)	Response to Query
G.703 Clock Extension	CEX	2 byte	<p>Command or Query. Sets or returns G.703 Clock Extension in the form ab, where: a = G.703 Clock Extension Mode (0=None; 1=TxLock; 2=RxEnable) b = G.703 Clock Extension Interface (0=T1; 1=E1Bal; 2=E1Unbal)</p> <p><b>Notes:</b> 1) Not all CEX modes are valid all the time. 2) For argument a:</p> <ul style="list-style-type: none"> <li>When Data Interface (ITF) is set to be G.703, Clock Extension Mode is automatically set to be 0=None. Response is ITF+</li> <li>When Tx Clock (TCK) is changed from Internal to Non-Internal, Clock Extension Mode will be automatically changed to 0=None if it was 1=TxLock. Response is TCK+</li> </ul> <p><b>Example:</b> &lt;0/CEX=12 (Sets Tx Lock to E1 Unbalanced)</p>	CEX= CEX? CEX* CEX#	CEX?	CEX=ab (see Description of Arguments)
T1 Line Build-Out	LBO=	1 byte, value of 0 thru 4	<p>Command or Query. <b>Valid only for T1 interface (in all modes other than T1, this is a don't care),</b> Sets or returns T1 Line build-out in the form x, where 0 = 0-133 feet 1 = 133-266 feet 2 = 266-399 feet 3 = 399-533 feet 4 = 533-655 feet</p> <p><b>Example:</b> &lt;0/LBO=2</p>	LBO= LBO? LBO * LBO #	LBO?	LBO=x (see Description of Arguments)
Tx BERT State	BTX=	1 byte, value of 0 or 1	<p>Command or Query. <b>Valid only in CDM-570A Compatible Mode (CMO=1).</b> Sets or returns Tx BERT State in the form x, where: 0 = Off 1 = On</p> <p><b>Example:</b> &lt;0/BTX=1 (Tx BERT On)</p>	BTX= BTX? BTX#	BTX?	BTX=x (see Description of Arguments)
Rx BERT State	BRX=	1 byte, value of 0 or 1	<p>Command or Query. <b>Valid only in CDM-570A Compatible Mode (CMO=1).</b> Sets or returns Rx BERT State in the form x, where: 0 = Off 1 = On</p> <p><b>Example:</b> &lt;0/BRX=1 (Rx BERT On)</p>	BRX= BRX? BRX#	BRX?	BRX=x (see Description of Arguments)

Parameter Type	Command (Instruction Code and Qualifier)	Arguments for Command or Response to Query	Description of Arguments	Response to Command	Query (Instruction Code and Qualifier)	Response to Query
Tx BERT Pattern	TBP=	1 byte	Command or Query. <b>Valid only in CDM-570A Compatible Mode (CMO=1).</b> Sets or returns Tx BERT Pattern, in the form x, where: 0=1:1 1=2047 2=2 <sup>15</sup> -1 3=2 <sup>23</sup> -1 <b>Example:</b> <0/TBP=1 (Tx BERT Pattern is 2047)	TBP= TBP? TBP#	TBP?	TBP=x (see Description of Arguments)
Rx BERT Pattern	RBP=	1 byte	Command or Query. <b>Valid only in CDM-570A Compatible Mode (CMO=1).</b> Sets or returns Rx BERT Pattern, in the form x, where: 0=1:1 1=2047 2=2 <sup>15</sup> -1 3=2 <sup>23</sup> -1 <b>Example:</b> <0/RBP=1 (Rx BERT Pattern is 2047)	RBP= RBP? RBP#	RBP?	RBP=x (see Description of Arguments)
BERT Error Insert	BKE=	1 byte, value of 0 or 1	Command only. <b>Valid only in CDM-570A Compatible Mode (CMO=1).</b> Inserts 1 error in the form x, where: x=1 <b>Example:</b> <0/BKE=1	BKE= BKE? BKE#	N/A	BKE=x (see Description of Arguments)
BERT Restart Monitor	BRM=	None	Command only. <b>Valid only in CDM-570A Compatible Mode (CMO=1).</b> <b>This command takes no arguments.</b> Restarts the BERT Monitor. <b>Example:</b> <0/BRM=	BRM=	N/A	N/A
BERT Result in bit errors	N/A	8 bytes	Query only. <b>Valid only in CDM-570A Compatible Mode (CMO=1).</b> Returns BERT monitor results in bit errors, in the form x.xxE+yy <b>Example:</b> <0/BRE? >0/BRE=8.70E+05	N/A	BRE?	BRE=x.xxE+yy

Parameter Type	Command (Instruction Code and Qualifier)	Arguments for Command or Response to Query	Description of Arguments	Response to Command	Query (Instruction Code and Qualifier)	Response to Query
BERT Result in average BER	N/A	9 bytes	<p>Query only.  <b>Valid only in CDM-570A Compatible Mode (CMO=1).</b>            Returns the value of the average BER in the form x.xxEsyyl, where:            First 8 bytes are the value.            Last byte is the indicator of Sync Loss. A '*' in last byte means there was a loss of pattern synchronization since last restart, but now is synchronized. A ' ' (space) in last byte means pattern synchronization is achieved.            Returns 999999999 if there's no sync in BERT monitor.  <b>Examples:</b> &lt;0/BRR?            1) &gt;0/BRR=2.80E-07 (BER is <math>2.80 \times 10^{-7}</math>, in sync)            2) &gt;/BRR=3.40E-05* (BER is <math>3.40 \times 10^{-5}</math>, and there was a Sync Loss)</p>	N/A	BRR?	BRR=x.xxEsyyl
ACM parameters	ACM=	4 bytes	<p>Command or Query.  <b>Valid only in CDM-570A Compatible Mode (CMO=1).</b>            Sets or returns ACM operating parameters in the form mMAT, where:  <b>VersaFEC ACM (IP-ACM):</b>            m=Minimum ModCod, range is 0 to 9, and A (for ModCod=10) or B (for ModCod=11)            M= Minimum ModCod, range is 0 to 9, and A (for ModCod=10) or B (for ModCod=11)            A= Defines action on remote demod unlock            0 = go to minimum Tx ModCod            1 = maintain Tx ModCod            T=Target Eb/No Margin, from 0 to 9 that is two times the Eb/No in dB (from 0.0dB to 4.5dB).  <b>VersaFEC-2 ACM (V2-ACM):</b>            mM=Maximum Tx ModCod in decimal, range is 00-37 for Long block, and 00-35 for Short Block.            A=Action on remote demod unlock (0=go to Tx ModCod 0)            T=Target Eb/No Margin, from 0 through 9 that is two times the Eb/No in dB (from 0.0dB to 4.5dB).  <b>Example:</b> &lt;0/ACM=0B12 (Sets min ModCod=0; max ModCod =11; maintains Tx ModCod when remote demod unlocks; sets Target Eb/No at 1.0dB.)</p>	ACM= ACM? ACM#	ACM?	ACM=mMAT (see Description of Arguments)
Configuration Load	CLD=	1 byte	<p>Command only.            Directs the CDM570AL to retrieve a previously stored modem configuration from the Configuration Memory location 0 through 9.  <b>Example:</b> &lt;0/CLD=4 (retrieves modem configuration from location 4)</p>	CLD= CLD? CLD* CLD#	N/A	N/A

Parameter Type	Command (Instruction Code and Qualifier)	Arguments for Command or Response to Query	Description of Arguments	Response to Command	Query (Instruction Code and Qualifier)	Response to Query
Configuration Save	CST=	1 byte	Command only. Directs the CDM570AL to store the current modem configuration into the Configuration Memory location 0 through 9. <b>Example:</b> <0/CST=4 (stores the current configuration in location 4)	CST= CST? CST* CST#	N/A	N/A
Force Reboot	FRB=	None	Command only. Forces a hard reset of the unit in 5 seconds.	FRB= FRB? FRB* FRB#	N/A	N/A
Demo Mode	DMM=	1 byte, value of 0 thru 2	Command or Query. Demo Mode Enable/Disable in the form of x, where: 0 = Disabled 1 = Enabled 2 = Expired <b>Note: Changing value from 0 to 1, or 1 to 0, causes the modem to turn off carrier output and reboot.</b>	DMM= DMM? DMM* DMM#	DMM?	DMM=x (see Description of Arguments)
Carrier ID State	CAI=	1 byte, 0 or 1	Command or Query. Sets or returns Carrier ID On/Off State in the form x, where: 0=Off 1=On	CAI= CAI? CAI * CAI #	CAI?	CAI =x (see Description of Arguments)
Carrier ID Latitude	LAT=	8 bytes	Command or Query. Sets or returns the Carrier ID Latitude, in the form ddaaamm.mmbbbD, where: dd=degrees Latitude, aaa=fixed value "deg". mm.mm=decimal minutes of the Latitude. Bbb=fixed value "min". D=direction (N (North) or S (South)). <b>EXAMPLE:</b> <0/LAT=33deg59.99minN (Latitude is 33°59.99' N)	LAT= LAT?	LAT?	LAT=ddaaamm.mmbbbD (see Description of Arguments)
Carrier ID Longitude	LNG=	9 bytes	Command or Query. Sets or returns the Carrier ID Longitude, in the form dddaaamm.mmbbbD, where: ddd=degrees Longitude, aaa=fixed value "deg". mm.mm=decimal minutes of the Longitude. bbb=fixed value "min". D=direction (E (East) or W (West)). <b>EXAMPLE:</b> <0/LNG=111deg59.99minE (Longitude is 111°59.99' E)	LNG= LNG?	LNG?	LNG=dddaaamm.mmbbbD (see Description of Arguments)
Carrier ID Telephone Number	PHN=	Up to 18 bytes	Command or Query. Sets or returns the Carrier ID Telephone Number (maximum length is 18 characters). <b>EXAMPLE:</b> <0/PHN=18664723963	PHN= PHN?	PHN?	PHN=x (see Description of Arguments)

Parameter Type	Command (Instruction Code and Qualifier)	Arguments for Command or Response to Query	Description of Arguments	Response to Command	Query (Instruction Code and Qualifier)	Response to Query
Carrier ID Custom Message	MSG=	Up to 24 bytes	Command or Query. Sets or returns the Carrier ID Custom Message (maximum length is 24 characters). Valid characters include printable ASCII characters from space (0x20) through ~ (0x7E) <b>EXAMPLE:</b> <0/MSG=Comtech EF Data	MSG= MSG?	MSG?	MSG=x (see Description of Arguments)



### 8.5.5 Bulk Configuration Commands and Queries

Parameter Type	Command (Instruction Code and Qualifier)	Arguments for Command or Response to Query	Description of Arguments	Response to Command	Query (Instruction Code and Qualifier)	Response to Query
OGC Outdoor Unit Global Configuration	OGC=	50 Bytes	<p>Command or Query – CDM/R-570AL only.</p> <p>Sets or returns ODU Global Configuration of CDM/R-570AL in the form aabcdexxxxhhhhiiiijjjjkxxxxxxlmnnnoooooppppqxxxxxx, where:</p> <p>aa = BUC Address same as BAD            b = BUC FSK comms enable same as BCE            c = BUC Power Control same as BPC            d = BUC 10MHz Frequency Reference enable same as BFR            e = BUC Tx Output Enable same as BOE            xxxx = expansion bytes            hhhh = BUC Low Alarm Limit same as BCL            iiii = BUC High Alarm Limit same as BCH            jjjjk = BUC LO frequency, mix sign same as BLO            xxxxxx = expansion bytes            l = LNB Power Control            m = LNB 10MHz Frequency Reference enable same as LPC            nnn = LNB Low Alarm Limit same as LFR            ooo = LNB High Alarm Limit same as LCL            pppppq = LNB LO Frequency, mix sign same as LCH            xxxxxx = expansion bytes same as LLO</p> <p>Any unavailable parameters will be filled with xxx.</p>	OGC= OGC? OGC* OGC#	OGC?  OGC?n	OGC=aabcdexxxxhhhhiiiijjjjkxxxxxxlmnnnoooooppppqxxxxxx  Where n=0 to 9 returns the OGC portion of 1 of 10 stored configs  (see Description of Arguments)
Global Configuration in CDM-570A Compatible Mode (CMO=1)	MGC=	200 bytes, with numerical entries, fixed values, and delimiters.	<p>Command or Query.</p> <p>Sets or returns Global Configuration of CDM570AL, in CDM-570A Compatible Mode (CMO=1), in the form shown in Response to Query column, where:</p> <p>a = Unit Interface Type same as ITF            b = T1 Line build-out same as LBO            c = Unit Framing mode same as FRM            dddd.dddd = Tx Frequency same as TFQ            e = Tx FEC Type same as TFT            f = Tx Modulation type same as TMD            g = Tx FEC Rate same as TCR            hhhh.hhh = Tx Data Rate same as TDR            i = Tx Spectrum Inversion same as TSI</p>	MGC= MGC? MGC* MGC#	MGC?  MGC?n	MGC=abcdddd.ddd defghhhh.hhhjkk.k lmnoppp.pppqrstxxx AAAA.AAAABCDE EEEE.EEEFGHIIJJ .JKLMxxxxxxNOPP PQRRRRRRRRRR RRRSTUVxxxxxm MATrrrr.rrrsss.sss abxcdfffgggGGGh xxxxxxxxxxxxxxxxxx xxxxxxxxxxxxxxxxxx xxxxxxxxxxxxxxxxxx

Parameter Type	Command (Instruction Code and Qualifier)	Arguments for Command or Response to Query	Description of Arguments	Response to Command	Query (Instruction Code and Qualifier)	Response to Query	
Global Configuration in CDM-570A Compatible Mode (CMO=1) (continued)			j = Tx Scrambler State kk.k = Tx Power Level l = Tx Clock Source m = Tx Data Invert n = Tx Carrier Stat o = AUPC Enable ppp.pp = AUPC parameter setup q = Warm-up delay rr = G.703 Clock Extension s = Tx Alpha t = Tx Clock Invert xxx = 3 expansion bytes AAAA.AAAA = Rx Frequency B = Rx FEC Type C = Rx Modulation Type D = Rx FEC Rate EEEEE.EEE = Rx Data Rate F = Rx Spectrum Inversion G = Rx Descrambler state H = Rx Data Invert III = Rx Sweep Width JJ.J = Eb/No Alarm Point K = Rx Buffer Size L = Rx Alpha M = Rx Clock Invert xxxxxx = 6 expansion bytes N = External Reference Frequency O = EDMAC Framing Mode PPPP = EDMAC Slave Address Q = Unit test Mode (Read only) RRRRRRRRRRRR = Unit Alarm Mask S=RTS/CTS Control T = Statistics Sampling Interval U = Attach BUC Alarm to Tx Alarm V = Attach LNB Alarm to Rx Alarm xxxxxx = 6 expansion bytes mMAT= ACM parameters	same as TSC same as TPL same as TCK same as TDI same as TXO same as AUP same as APP same as WUD same as CEX same as TXA same as TCI  same as RFQ same as RFT same as RMD same as RCR same as RDR same as RSI same as RDS same as RDI same as RSW same as EBA same as RBS same as RXA same as RCI  same as ERF same as EFM same as ESA same as TST same as MSK same as RTS same as SSI same as ABA same as ALA  same as ACM			(see Description of Arguments)  Where n=0 to 9 Returns the MGC portion of 1 of 10 stored configurations (see Description of Arguments)



Parameter Type	Command (Instruction Code and Qualifier)	Arguments for Command or Response to Query	Description of Arguments	Response to Command	Query (Instruction Code and Qualifier)	Response to Query
Global Configuration in CDM-570 Compatible Mode (CMO=0) (continued)			rr = G.703 Clock Extension sssss = expansion bytes AAAA.AAAA = Rx Frequency B = Rx FEC Typ C = Rx Modulation Type D = Rx FEC Rate EEEE.EEE = Rx Data Rate F = Rx Spectrum Inversion G = Rx Descrambler state H = Rx Data Invert III = Rx Sweep Width JJ.J = Eb/No Alarm Point K = Rx Buffer Size LLLLLLLL = expansion bytes M = External Reference Frequency N = EDMAC Framing Mode OOOO = EDMAC Slave Address P = Unit test Mode (Read only) QQQQQQQQQQQQ = Unit Alarm Mask R=RTS/CTS Control S = Statistics Sampling Interval T = Attach BUC Alarm to Tx Alarm U = Attach LNB Alarm to Rx Alarm VVVVVV = expansion bytes Fill unused expansion bytes with 'x'	same as CEX  same as RFQ same as RFT same as RMD same as RCR same as RDR same as RSI same as RDS same as RDI same as RSW same as EBA same as RBS  same as ERF same as EFM same as ESA same as TST same as MSK same as RTS same as SSI same as ABA same as ALA		

## 8.5.6 Modem Information Commands and Queries

Parameter Type	Command (Instruction Code and Qualifier)	Arguments for Command or Response to Query	Description of Arguments	Response to Command	Query (Instruction Code and Qualifier)	Response to Query
Equipment ID in CDM-570A Compatible Mode (CMO=1)	N/A	36 bytes	<p>Query only. Returns information concerning the equipment identification and the option field, in CDM-570A Compatible Mode (CMO=1), in the form abbcdefghi; where (<b>Software FAST options</b>):</p> <p>c = Reed-Solomon codec option: 0 = None 1 = Installed</p> <p>bbb defines the modem model number: 570 = CDM-570A, 571 = CDM/R-570AL</p> <p>a = Turbo option: 0 = None, 1 = All Turbo code rate but 0.95 2 = All Turbo code rate</p> <p>d = Tx VersaFEC codec data rate option: 0 = None 1 = up to 512 kbps 2 = up to 1100 kbps 3 = up to 2500 kbps 4 = up to 5000 kbps 5 = up to 10239 kbps</p> <p>e = Data Rate Option: 0 = Base (512 kbps) 1 = up to 1100 kbps 2 = up to 2500 kbps 3 = up to 5000 kbps 4 = up to 10239 kbps</p> <p>f = Higher-order modulation: 0 = None 1 = 8-PSK/8-QAM 2 = 16QAM 3 = 8-PSK/8-QAM and 16QAM 4 = 8-PSK/8-QAM, 16QAM, 8-ARY, 16-ARY, and 32-ARY</p>	N/A	EID?	EID= cbbbadefghijklmnop qrstABCDuuuuuuuu uu (see Description of Arguments)

Parameter Type	Command (Instruction Code and Qualifier)	Arguments for Command or Response to Query	Description of Arguments	Response to Command	Query (Instruction Code and Qualifier)	Response to Query
Equipment ID in CDM-570A Compatible Mode (CMO=1) (continued)			<p>g = Tx Roll Off Factor (5%, 10%, 15%, 20%, 25%) data rate option:            0 = None            1 = up to 512 kbps            2 = up to 1100 kbps            3 = up to 2500 kbps            4 = up to 5000 kbps            5 = up to 10239 kbps</p> <p>h = CnC Datarate option:            0 = None            1 = full up to 512 kbps            2 = full up to 1100 kbps            3 = full up to 2500 kbps            4 = full up to 5000 kbps            5 = full up to 10239 kbps            6 = fractional up to 2500 kbps            7 = fractional up to 5000 kbps            8 = fractional up to 10239 kbps</p> <p>i = CnC APC option:            0 = None            1 = Installed</p> <p>j = Carrier ID option:            0 = None            1 = Installed</p> <p>k = spare (0):</p> <p>l = BUC option:            0 = None            1 = 100 Watt            2 = 150 Watt</p> <p>m = G.703 Clock Extension:            0 = None            1 = Installed</p> <p>n = VersaFEC ACM symbol rate option:            0 = None            1 = up to 375ksps            2 = up to 750ksps            3 = up to 1500ksps            4 = up to 2000ksps            5 = up to 3000ksps</p>			

Parameter Type	Command (Instruction Code and Qualifier)	Arguments for Command or Response to Query	Description of Arguments	Response to Command	Query (Instruction Code and Qualifier)	Response to Query
Equipment ID in CDM-570A Compatible Mode (CMO=1) (continued)			o = 3xDES Encryption option: 0 = None 1 = Installed p = IP Header Compression option: 0 = None 1 = Installed q = IP Payload Compression option: 0 = None 1 = Installed r = IP QoS option: 0 = None 1 = Installed s = Vipersat option: 0 = None 1 = Installed t = VFS data rate option: 0 = None 1 = full 512 kbps 2 = full 1100 kbps 3 = full 2500 kbps <b>Installed Hardware:</b> A = TPC 0.95 card 0 = None 1 = Installed B = CnC card 0 = None 1 = Installed C = Expansion card 0 = None 1 = Installed D = Packet Processor card 0 = None 1 = Installed uuuuuuuuu = spares (0)			

Parameter Type	Command (Instruction Code and Qualifier)	Arguments for Command or Response to Query	Description of Arguments	Response to Command	Query (Instruction Code and Qualifier)	Response to Query
Equipment ID in CDM-570 Compatible Mode (CMO=0)	N/A	11 bytes	<p>Query only. Returns information concerning the equipment identification and the option field, in CDM-570 Compatible Mode (CMO=0), in the form abbcdefghi; where:</p> <p>a = Turbo option: 0 = None, 1 = Turbo</p> <p>bbb defines the modem model number: 570 = CDM-570A, 571 = CDM/R-570AL</p> <p>c = Expansion slot: 0 = None 1 = Reed-Solomon codec installed</p> <p>d = Data Rate Option: 0 = Base (512 kbps) 1 = up to 2048 kbps 2 = up to 5000 kbps 3 = up to 10239 kbps</p> <p>e = Higher-order modulation: 0 = None 1 = 8-PSK/8-QAM 2 = 16QAM 3 = 8-PSK/8-QAM and 16QAM</p> <p>f = Packet Processor: 0 = None 1 = IP Mod_v1 2 = IP Mod_v2</p> <p>g = BUC option: 0 = None 1 = 100 Watt 2 = 150 Watt</p> <p>h = G.703 Clock Extension: 0 = None 1 = Installed</p> <p>i = G.703 Line Interface 0 = None 1 = Installed</p>	N/A	EID?	<p>EID= abbcdefghi (see Description of Arguments)</p> <p>570 is the CDM-570A 571 is the CDM-570A L-Band</p>



Parameter Type	Command (Instruction Code and Qualifier)	Arguments for Command or Response to Query	Description of Arguments	Response to Command	Query (Instruction Code and Qualifier)	Response to Query
Equipment ID in CDM-570 Compatible Mode (CMO=0) (continued)			<b>Example:</b> <0/EID? >0/EID=1571013111x means Turbo, CDM/R-570AL, no RS codec, up to 2048bps, 8-PSK/8-QAM and 16-QAM, Packet Processor installed, 100 Watt BUC supply installed, G.703 Clock Extension option installed			
Software Information	N/A	variable	Query only. Returns the unit's complete software information. <b>Example:</b> <0/FRW? >0/FRW=Boot: FW-0020684-,1.1.1 ,07/12/13 Bulk1: FW-0020683-,1.1.1,03/17/14 FW-0020685-,1.1.1,03/17/14 FW-0020686-,1.2.8,02/14/14 FW-0020687-,1.1.22,11/08/13 FW-0020688-,1.1.5 ,11/05/13 FW-0000516-,1.1.1 ,19/01/11 Bulk2: FW-0020683-,1.1.1 ,02/14/14 FW-0020685-,1.1.1 ,02/14/14 FW-0020686-,1.2.7 ,01/28/14 FW-0020687-,1.1.22,11/08/13 FW-0020688-,1.1.5 ,11/05/13 FW-0000516-,1.1.1 ,19/01/11	N/A	FRW?	FRW=x...x (see Description of Arguments)
Software Revision	N/A	34-37 bytes	Query only. Returns the value of the internal software revision installed in the unit, in the form: Boot:x.y.z Bulk1:x.y.z Bulk2:x.y.z or Boot:x.y.zz Bulk1:x.y.zz Bulk2:x.y.zz	N/A	SWR?	SWR=Boot:x.y.zz Bulk1:x.y.zz Bulk2:x.y.zz (see description of arguments)
Serial Number	N/A	9 bytes	Query only. Returns the unit's 9-digit serial number. <b>Example:</b> <0/SNO? >0/SNO=176500143	N/A	SNO?	SNO=xxxxxxxx (see Description of Arguments)

Parameter Type	Command (Instruction Code and Qualifier)	Arguments for Command or Response to Query	Description of Arguments	Response to Command	Query (Instruction Code and Qualifier)	Response to Query
Fractional CnC 90-day Counter	N/A	7 bytes	Query Only. Returns the number of seconds that Fractional CnC license has been used in 1 year period since the last time the CnC counter was reset to 0. <b>Example:</b> <0/FCC? >0/FCC=0000455 (indicating 455 seconds)	N/A	FCC?	=xxxxxxx (see Description of Arguments)
Modem Operational Full Year Counter	N/A	8 bytes	Query Only. Returns the number of seconds that the unit has been powered on since last reset of the counter. The counter resets to 0 when it reaches 31536000 seconds (seconds in 365 days). <b>Example:</b> <0/SFCF? >0/FCF=00001342 (indicating 1342 seconds)	N/A	FCF?	xxxxxxxx (see Description of Arguments)

## 8.5.7 Modem Performance Information

Parameter Type	Command (Instruction Code and Qualifier)	Arguments for Command or Response to Query	Description of Arguments	Response to Command	Query (Instruction Code and Qualifier)	Response to Query
Rx Signal Level	N/A	4 bytes	Query Only. Returns the value of the Rx signal level, in dBm, from -5 to -99 dBm, in the form ccxx, where: cc = code (GT= greater than; LT = less than, == is 'equal to') xx = value (the '-' sign is implied) <b>Examples:</b> <0/RSL? 1) >0/RSL=LT99 (Rx signal level is less than -99 dBm) 2) >0/RSL===41 (Rx signal level is equal to -41 dBm)	N/A	RSL?	RSL=ccxx (see description of arguments)
Rx Frequency Offset	N/A	6 bytes	Query only. Returns the value of the measured frequency offset of the carrier being demodulated, range from $\pm 0$ to $\pm 32$ kHz, in the form sxxx.x, where: s = sign (+ or -) xxx.x = value Resolution = 100 Hz Unit returns +999.9 if the demodulator is unlocked. <b>Note:</b> The maximum Rx Frequency Offset corresponds to the Receive Sweep Width (RSW) <b>Example:</b> <0/RFO? >0/RFO=+002.3 (+2.3 kHz)	N/A	RFO?	RFO=sxxx.x (See Description of Arguments)
Buffer Fill State	N/A	2 bytes	Query only. Unit returns the value of the buffer fill state, from 1 to 99%. Returns 00 if demodulator is unlocked. <b>Example:</b> <0/BFS? >0/BFS=33 (33%)	N/A	BFS?	BFS=xx (See Description of Arguments)
Rx BER	N/A	5 bytes	Query only. Returns the value of the estimated corrected BER in the form a.bE <sup>-c</sup> where: a.b = value E <sup>-c</sup> = exponent. Returns 99999 if the demodulator is unlocked. <b>Example:</b> <0/BER? >0/BER=4.8E3 (BER = $4.8 \times 10^{-3}$ )	N/A	BER?	BER=a.bEc (see description of arguments)

Parameter Type	Command (Instruction Code and Qualifier)	Arguments for Command or Response to Query	Description of Arguments	Response to Command	Query (Instruction Code and Qualifier)	Response to Query
Rx Eb/No	N/A	4 bytes	Query only. Returns the value of Eb/No, from 0 to 16 dB, in the form xxxx, resolution= 0.1 dB. Returns 99.9 if demod is unlocked. For values >16.0 dB, Response = EBN+=016 <b>Example:</b> <0/EBN? >0/EBN=12.3 (Eb/No = 12.3 dB)	N/A	EBN?	EBN=xxxx (see Description of Arguments)
Redundancy State	N/A	1 bytes, 0 or 1	Query only. Returns the redundancy state of the unit in the form x, where: 0 = Offline 1 = Online <b>Example:</b> <0/RED? >0/RED=1 (selects Online)	N/A	RED?	RED=x (See Description of Arguments)
Temperature	N/A	3 bytes	Query only. Returns the unit internal temperature, in degrees C, in the form sxx, where: s = sign (+ or -) xx = value <b>Example:</b> <0/TMP? >0/TMP=+26	N/A	TMP?	TMP=sxx (see Description of Arguments)
Offline Unit Status	N/A	6 bytes	Query only. (1:1 set-up) Sent to the online modem of a 1:1 pair. Returns the fault status information (FLT?) of the offline modem in the form abcdef, where: abcdef = The FLT? response information from the offline unit <b>Note:</b> This is the only way to interrogate the status of an offline modem at the distant-end of a link.	N/A	OUS?	OUS=abcdef (see Description of Arguments)
ACM Remote Signal Noise Ratio	N/A	4 bytes	Query only. Returns the value of SNR of the remote demod in the form xx.x, where: 99.9=Demod is unlocked. xx.x=Not in ACM. <b>EXAMPLE:</b> <0/RSN? >0/RSN=12.4	N/A	RSN?	RSN=xx.x (see Description of Arguments)
ACM Local Signal Noise Ratio	N/A	4 bytes	Query only. Returns the value of Local Signal Noise Ratio in the form xx.x, where: 99.9=demod is unlocked. <b>EXAMPLE:</b> <0/SNR? >0/SNR=12.3 (indicates SNR @12.3 dB)	N/A	SNR?	SNR=xx.x (see Description of Arguments)

Parameter Type	Command (Instruction Code and Qualifier)	Arguments for Command or Response to Query	Description of Arguments	Response to Command	Query (Instruction Code and Qualifier)	Response to Query
Faults and Status	N/A	6 bytes	<p>Query only. Returns the current <b>highest-priority</b> fault and status codes for the Unit (hardware), Tx Traffic, Rx Traffic and ODU in the form abcdef, where:</p> <p><b>a = Unit faults:</b></p> <ul style="list-style-type: none"> <li>0 = No faults</li> <li>1 = Power supply fault, +5 volts</li> <li>2 = Power supply fault, +12 volts</li> <li>3 = Power supply fault, -5 volts</li> <li>4 = Reserved</li> <li>5 = Power supply fault, -12 volts</li> <li>6 = Tx synthesizer lock</li> <li>7 = Rx 1st LO synthesizer lock</li> <li>8 = Rx 2<sup>nd</sup> LO synthesizer Lock</li> <li>9 = Ref PLL lock</li> <li>A = Reserved</li> <li>B = Reserved</li> <li>C = Reserved</li> <li>D = Reserved</li> <li>E = Packet Processor</li> <li>F = Reserved</li> </ul> <p><b>b = Tx Traffic status:</b></p> <ul style="list-style-type: none"> <li>0 = Tx traffic OK</li> <li>1 = No clock from terrestrial interface</li> <li>2 = Tx PaP ETH Link Down</li> <li>3 = Tx FIFO slip</li> <li>4 = G.703 Loss of Signal (valid only in Clock Extend Mode)</li> <li>5 = Loss of External Reference</li> <li>6 = Reserved</li> <li>7 = AUPC upper limit reached</li> <li>8 = Reserved</li> <li>9 = AIS detected on incoming data</li> <li>A = Reserved</li> <li>B = Bipolar violation on G.703 interface</li> <li>C = Reserved</li> <li>D = Reserved</li> <li>E = Reserved</li> <li>F = BUC Alarm (if attached)</li> </ul>	N/A	FLT?	FLT=abcdef (see Description of Arguments)

Parameter Type	Command (Instruction Code and Qualifier)	Arguments for Command or Response to Query	Description of Arguments	Response to Command	Query (Instruction Code and Qualifier)	Response to Query
Faults and Status (continued)			<p>c = Rx Traffic status:</p> <ul style="list-style-type: none"> <li>0 = Rx Traffic OK</li> <li>1 = Demodulator unlocked</li> <li>2 = Reserved</li> <li>3 = AGC Alarm - signal out of range</li> <li>4 = Reserved</li> <li>5 = RS Frame sync alarm</li> <li>6 = Reserved</li> <li>7 = EDMAC Frame sync alarm</li> <li>8 = APC Band mismatch alarm               <ul style="list-style-type: none"> <li>A = Buffer Underflow</li> <li>B = Buffer Overflow</li> <li>D = Eb/No alarm</li> <li>E = LNB Alarm (if attached)</li> <li>F = AIS detected on incoming data</li> </ul> </li> <li>9 = Reserved               <ul style="list-style-type: none"> <li>A = Buffer Underflow</li> <li>B = Buffer Overflow</li> <li>C = Reserved</li> <li>D = Eb/No alarm</li> <li>E = LNB Alarm (if attached)</li> <li>F = AIS detected on incoming data</li> </ul> </li> </ul>			

Parameter Type	Command (Instruction Code and Qualifier)	Arguments for Command or Response to Query	Description of Arguments	Response to Command	Query (Instruction Code and Qualifier)	Response to Query
Faults and Status (continued)			<p><b>d = ODU status:</b>            0 = No ODU faults            1 = BUC PLL            2 = Reserved            3 = BUC current            4 = Reserved            5 = BUC voltage            6 = Reserved            7 = LNB current            8 = Reserved            9 = LNB voltage              A = Reserved              B = BUC temperature              C = Reserved              D = BUC software checksum              E = Reserved              F = Reserved</p> <p><b>e = Change in fault status since last poll:</b>            0 = No fault changes since last poll            1 = Faults have occurred</p> <p><b>f = Change in unit configuration since last poll:</b>            0 = No configuration changes since last poll            1 = Configuration changes have occurred</p>			
CnC Ratio Monitor	N/A	4 bytes	<p>Query only.  <b>Valid only in CDM-570A Compatible Mode (CMO=1).</b>            Monitors the ratio, in dB, between the interferer and the desired power when CnC is enabled and the modem is locked.  <b>Examples:</b> &lt;0/CRM?            1) &gt;0/CRM=+02 (interferer&gt;desired) (format = sdd)            2) &gt;0/CRM=LT11 (less than -11 dB)            3) &gt;0/CRM=GT11 (greater than +11 dB)            4) &gt;0/CRM=99.9 (CnC not locked or CnC not enabled)            5) &gt;0/CRM=AUTO (in CnC-APC mode)            6) &gt;0/CRM=88.8 (In CnC mode, but Tx carrier is off)</p>	N/A	CRM?	CRM=xxxx (see Description of Arguments)

Parameter Type	Command (Instruction Code and Qualifier)	Arguments for Command or Response to Query	Description of Arguments	Response to Command	Query (Instruction Code and Qualifier)	Response to Query
CnC Delay Monitor	N/A	6 bytes	Query only. <b>Valid only in CDM-570A Compatible Mode (CMO=1).</b> Monitors the delay, in microseconds, of the interferer when CnC is enabled and the modem is locked. <b>Examples:</b> <0/CDM? 1) >0/CDM=229500 (229.5 ms) 2) >0/CDM=999999 (CnC not locked or CnC not enabled) 3) >0/CDM=888888 (In CnC mode, but Tx carrier is off)	N/A	CDM?	CDM=xxxxxx (see Description of Arguments)
CnC Freq Offset Monitor	N/A	6 bytes	Query only. <b>Valid only in CDM-570A Compatible Mode (CMO=1).</b> Calculates an estimated frequency offset, in kHz, between the interferer and the desired power when CnC is enabled. <b>Examples:</b> <0/CFF? 1) >0/CFF=+001.0 (1 kHz) 2) >0/CFF=9999.9 (CnC not locked or CnC not enabled) 3) >0/CFF=8888.8 (In CnC mode, but Tx carrier is off)	N/A	CFF?	CFF=xxxxxx (see Description of Arguments)
CnC Power Ratio Monitor	N/A	6 bytes	Query only. <b>Valid only in CDM-570A Compatible Mode (CMO=1).</b> When CnC is enabled and the modem is locked, ratio (in dB) between the interferer and the desired power is monitored, with 0.1dB resolution. <b>Examples:</b> <0/CPR? 1) >0/CPR=+02.8 (interferer>desired) (format = sdd.d) 2) >0/CPR=LT11.0 (less than -11.0 dB) 3) >0/CPR=GT19.0 (greater than +19.0 dB) 4) >0/CPR=9999.9 (not locked or CnC not enabled) 5) >0/CPR=AUTO (in CnC-APC mode)	N/A	CPR?	CPR=xxxxxx (see Description of Arguments)
CnC PSDR	N/A	5 bytes	Query only. <b>Valid only in CDM-570A Compatible Mode (CMO=1).</b> When CnC is enabled and the modem is locked, ratio (in dB) between the interferer and the desired power is monitored, with 0.1 dB resolution. <b>Examples:</b> <0/PSD? 1) >0/PSD=+02.8 (interferer>desired) (format = sdd.d) 2) >0/PSD=999.9 (not locked or CnC not enabled) 3) >0/PSD=AUTO (in CnC-APC mode)	N/A	PSD?	PSD=xxxxx (see Description of Arguments)



Parameter Type	Command (Instruction Code and Qualifier)	Arguments for Command or Response to Query	Description of Arguments	Response to Command	Query (Instruction Code and Qualifier)	Response to Query
CnC-APC Bit Error Rate	N/A	4 bytes	Query only. <b>Valid only in CDM-570A Compatible Mode (CMO=1).</b> Returns the value of CnC-APC BER in the form $xE^{-c}$ , where: x = value E <sup>-c</sup> = Exponent. Returns 9999 if unit is not in CnC-APC mode or if there is an APC frame sync error. BER is measured in frame UW. <b>Example:</b> <0/ABE? >0/ABE=8E-5	N/A	ABE?	ABE= $xE^{-c}$ (see Description of Arguments)
CnC-APC BER Reset	ABR=	None	Command only. <b>Valid only in CDM-570A Compatible Mode (CMO=1).</b> <b>This command takes no arguments.</b> Restarts CnC-APC BER measurement.	ABR=	N/A	N/A
CnC-APC Frame Error Rate	N/A	4 bytes	Query only. <b>Valid only in CDM-570A Compatible Mode (CMO=1).</b> Returns the value of CnC-APC FER in the form $xE^{-c}$ , where: x = value E <sup>-c</sup> = Exponent. Returns 9999 if modem is not in CnC-APC mode or if there is an APC frame sync error. <b>Example:</b> <0/AFE? >0/AFE=8E-2	N/A	AFE?	AFE= $xE^{-c}$ (see Description of Arguments)
CnC-APC FER Reset	AFR=	None	Command only. <b>Valid only in CDM-570A Compatible Mode (CMO=1).</b> <b>This command takes no arguments.</b> Restarts CnC-APC FER measurement.	AFR=	N/A	N/A
CnC-APC Activate/Suspend	APC=	1 byte, 0 thru 2	Command only. <b>Valid only in CDM-570A Compatible Mode (CMO=1).</b> Activates or suspends APC operation in the form x, where: 0 = no action 1 = Activate APC 2 = Suspend APC	APC=	N/A	N/A

Parameter Type	Command (Instruction Code and Qualifier)	Arguments for Command or Response to Query	Description of Arguments	Response to Command	Query (Instruction Code and Qualifier)	Response to Query
CnC-APC State	N/A	2 bytes	<p>Query only.  <b>Valid only in CDM-570A Compatible Mode (CMO=1).</b>  Returns the state of APC operation in form xx, where:  00 = APC is not active  01 = No Solution  02 = OK - ReBalance Done  03 = OK(Partial): CnC Ratio approaches limit  04 = OK(Partial): Local power approaches minimum value (-25 dBm for IF band)  05 = OK(Partial): Local power approaches minimum value (-40 dBm for L-Band)  06 = OK(Partial): Local power approaches maximum value (0 dBm)  07 = OK(Partial): Local power approaches limit set by max power level increase  08 = OK(Partial): Distant power approaches minimum value (-25 dBm for IF band)  09 = OK(Partial): Distant power approaches minimum value (-40 dBm for L-Band)  10 = OK(Partial): Distant power approaches maximum value (0 dBm)  11 = OK(Partial): Distant power approaches limit set by max power level increase  12 = OK(Partial): Incomplete  13 = No APC Frame Sync  14 = CnC Ratio Problem  15 = Local EbNo too high  16 = Distant EbNo too high  17 = Distant End ReBalance failed  18 = Distant End NoResponse  19 = Fail-Calculate Mismatch  20 = CnC Ratio too high  21 = Please run again  22 = APC is active  23 = Local margin too low  24 = Distant margin too low  25 = Rx Data Rate&lt;64kbps  26 = Tx Data Rate&lt;64kbps  27 = Local RSL too low  28 = Distant RSL too low</p>	N/A	APS?	APS=xx (see Description of Arguments)

Parameter Type	Command (Instruction Code and Qualifier)	Arguments for Command or Response to Query	Description of Arguments	Response to Command	Query (Instruction Code and Qualifier)	Response to Query
CnC-APC Max Power Level Increase	APL=	3 bytes	<p>Command or Query.  <b>Valid only in CDM-570A Compatible Mode (CMO=1).</b>  Sets or returns CnC-APC maximum power level increase, limited by Tx power level, in the form xx.x, where:  xx.x = value from 0.0 to 9.9 dB.  <b>Example:</b> &lt;0/APL=3.9 (APC max power level increase is 3.9 dB.).</p>	<p>APL=  APL?  APL*  APL#</p>	APL?	APL=xx.x (see Description of Arguments)
CnC-APC Home State	AHS=	12 bytes	<p>Command or Query.  <b>Valid only in CDM-570A Compatible Mode (CMO=1).</b>  <b>Note:</b> Command is only for Offline unit, sent by switch in a 1:N Redundancy system, or Online unit in a 1:1 Redundancy system.  Returns CnC-APC home state parameters in the form a,bbb,cc,ddd, where:  a = APC state. (1 = APC is active, 0 = APC is not active)  bbb = APC home state Tx power, in 0.1dB. (minus sign assumed)  cc = APC home state max power level increase, in 0.1 dB.  ddd = APC Tx power threshold, in 0.1 dB. (minus sign assumed)  <b>Example:</b> &lt;0/AHS=1,100,60,085 (APC is active, home state power is -10.0 dB, home state max power level increase is 6.0 dB, power threshold is -8.5 dB)</p>	<p>AHS=  AHS?  AHS*  AHS#</p>	AHS?	AHS=a,bbb,cc,ddd (see Description of Arguments)

## 8.5.8 BUC (L-Band Block Up Converter) Commands and Queries (CDM/R-570AL ONLY)

Parameter Type	Command (Instruction Code and Qualifier)	Arguments for Command or Response to Query	Description of Arguments	Response to Command	Query (Instruction Code and Qualifier)	Response to Query
Attach summary BUC fault to Tx FLT status	ABA=	1 byte, 0 or 1	Command or Query. Sets or returns BUC fault-to-Tx fault disposition in the form x, where: 0 = Tx FLT status unaffected by BUC fault 1 = Attach a summary BUC fault to Tx FLT status	ABA= ABA? ABA* ABA#	ABA?	ABA=x (see Description of Arguments)
BUC Address	BAD=	2 bytes, value of 01 to 15	Command or Query. Sets or returns the BUC Address, in the form xx, where: xx = address from 01 to 15. <b>Example:</b> <0/BAD=03	BAD = BAD? BAD * BAD #	BAD?	BAD=xx (see Description of Arguments)
BUC Comms enable	BCE=	1 byte, value of 0 or 1	Command or Query. Sets or returns communications, via the FSK link, with an externally connected Block Up Converter (BUC) in the form x, where: 0 = Disabled 1 = Enabled <b>Example:</b> <0/BCE=0 (Disabled)	BCE= BCE? BCE* BCE#	BCE?	BCE=x (see Description of Arguments)
BUC High Current Limit	BCH=	4 bytes	Command or Query. Sets or returns BUC High Current Limit, in mA, the form xxxx, where: xxxx = value from 500 to 4000 <b>Example:</b> <0/BCH=3100	BCH= BCH? BCH* BCH#	BCH?	BCH=xxxx (see Description of Arguments)
BUC Low Current Limit	BCL=	4 bytes	Command or Query. Sets or returns BUC Low Current Limit, in mA, the form xxxx, where: xxxx = value from 0 to 3000 <b>Example:</b> <0/BCL=0600	BCL= BCL? BCL* BCL#	BCL?	BCL=xxxx (see Description of Arguments)
BUC Current	N/A	4 bytes	Query only. Returns BUC Current, in mA, in the form xxxx, where: xxxx = value from 0 to 9999 When unavailable, response is 0000. <b>Example:</b> <0/BDC=3100	N/A	BDC?	BDC=xxxx (see Description of Arguments)
BUC Voltage	N/A	4 bytes	Query only. Returns BUC Voltage, in the form xx.x, where: xx.x = value from 0 to 64.0 When unavailable, response is 00.0. <b>Example:</b> <0/BDV=43.6 (BUC DC voltage is 43.6 volts)	N/A	BDV?	BDV=xx.x (see Description of Arguments)

Parameter Type	Command (Instruction Code and Qualifier)	Arguments for Command or Response to Query	Description of Arguments	Response to Command	Query (Instruction Code and Qualifier)	Response to Query
BUC 10 MHz Reference	BFR=	1 byte, value of 0 or 1	Command or Query. Sets or returns BUC 10 MHz frequency reference, where: 0 = Disabled 1 = Enabled <b>Example:</b> <0/BFR=0 (BUC 10MHz reference disabled)	BFR= BFR? BFR* BFR#	BFR?	BFR=x (see Description of Arguments)
BUC LO Frequency	BLO=	6 bytes	Command or Query. Sets or returns BUC Tx LO frequency information in the form xxxxs, where: xxxxx = LO frequency, in the range from 3000 to 65000 MHz. (All 0's (000000) disables the feature) s = sign for the mix (+ or -) <b>Note:</b> Terminal Frequency = BUC LO ± TFO <b>Example:</b> <0/BLO = 12000+ (BUC LO is 12 GHz, low-side mix)	BLO= BLO? BLO* BLO#	BLO?	BLO=xxxxs (see Description of Arguments)
BUC Output Enable	BOE=	1 byte, value of 0 or 1	Command or Query. Sets or returns BUC Output in the form x, where: 0 = Off (output disabled) 1 = On (output enabled) <b>Example:</b> <0/BOE=1 (BUC output is enabled)	BOE= BOE? BOE* BOE#	BOE?	BOE=x (see Description of Arguments)
BUC Output Power Level	N/A	4 bytes	Query only. Returns BUC Output Power Level, in Watts, in the form xx.x. Returns 00.0 when FSK and BUC power are not enabled. <b>Example:</b> <0/BOL? >0/BOL=08.3 (BUC reports output power is 8.3 Watts)	N/A	BOL?	BOL=xx.x (see Description of Arguments)
BUC PLL Alarm	N/A	1 byte, value of 0 or 1	Query only. Returns BUC PLL lock state in the form x, where: 1 = Unlocked 0 = Locked When unavailable, response is 9. <b>Note:</b> Command valid only when the FSK and BUC power are turned On. <b>Example:</b> <0/BPA? <0/BPA=0 (BUC PLL is locked)	N/A	BPA?	BPA=x (see Description of Arguments)
BUC Power Control	BPC=	1 byte, value of 0 or 1	Command or Query – <b>CDM-570L only.</b> 0 = Disable BUC DC Power 1 = Enable BUC DC Power <b>Example:</b> <0/BPC=0 (BUC DC power disabled)	BPC= BPC? BPC* BPC#	BPC?	BPC=x (see Description of Arguments)

Parameter Type	Command (Instruction Code and Qualifier)	Arguments for Command or Response to Query	Description of Arguments	Response to Command	Query (Instruction Code and Qualifier)	Response to Query
BUC Software Version	N/A	2 bytes	Query only. Returns the BUC software version in the form xx. When unavailable, response is 00 <b>Note:</b> Command valid only when the FSK and BUC power are turned On. <b>Example:</b> <0/BSV? >0/BSV=05 (Software version 05)	N/A	BSV?	BSV=xx (see Description of Arguments)
BUC Temperature	N/A	3 bytes	Query only. Returns BUC temperature is returned, in the form sxx, where: s = sign (+ or -) xx = value When unavailable, response is -99 <b>Note:</b> This query is valid only when the FSK and BUC power are turned On. <b>Example:</b> <0/BUT? >0/BUT=-13 (BUC temperature is -13 degrees C)	N/A	BUT?	BUT=sxx (see Description of Arguments)

## 8.5.9 LNB (L-Band Low-noise Block Down Converter) Commands and Queries (CDM/R-570AL ONLY)

Parameter Type	Command (Instruction Code and Qualifier)	Arguments for Command or Response to Query	Description of Arguments	Response to Command	Query (Instruction Code and Qualifier)	Response to Query
Attach LNB Alarm to Rx Alarm	ALA=	1 byte, value of 0 or 1	Command or Query. Sets or returns LNB Alarm-to-Rx Alarm attachment, where: 0 = No 1 = Yes <b>Example:</b> <0/ALA=1 (Attach LNB Alarm to Rx Alarm)	ALA= ALA? ALA#	ALA?	ALA=x (see Description of Arguments)
LNB High current limit	LCH=	3 bytes	Command or Query. Sets or returns LNB upper alarm limit for current, in mA, in the form xxx, where: xxx = current value from 50 to 600 <b>Example:</b> <0/LCH=450	LCH= LCH? LCH* LCH#	LCH?	LCH=xxx (see Description of Arguments)
LNB Low current limit	LCL=	3 bytes	Command or Query. Sets or returns LNB lower alarm limit for current, in mA, in the form xxx, where: xxx = current value from 10 to 400 <b>Example:</b> <0/LCL=050	LCL= LCL? LCL* LCL#	LCL?	LCL=xxx (see Description of Arguments)
LNB Current	N/A	3 bytes	Query only. Returns the value of the LNB Current, in mA, in the form xxx, where: xxx = current value from 0 to 999 When unavailable, response is 000. <b>Example:</b> <0/LDC? >0/LDC=210 (LNB DC current is 210 mA)	N/A	LDC?	LDC=xxx (see Description of Arguments)
LNB Voltage	N/A	4 bytes	Query only. Returns the value of LNB Voltage in the form xx.x, where: xx.x = voltage value from 0 to 30.0 When unavailable, response is 00.0. <b>Example:</b> <0/LDV? >0/LDV=24.2 (LNB DC voltage is 24.2 volts)	N/A	LDV?	LDV=xx.x (see Description of Arguments)
LNB Frequency Reference enable	LFR=	1 byte, value of 0 or 1	Command or Query. Sets or returns LNB Frequency Reference controls in the form x, where: 0 = Disable LNB Reference 1 = Enable LNB Reference <b>Example:</b> <0/LFR? >0/LFR=0 (LNB 10 MHz reference off)	LFR= LFR? LFR* LFR#	LFR?	LFR=x (see Description of Arguments)

Parameter Type	Command (Instruction Code and Qualifier)	Arguments for Command or Response to Query	Description of Arguments	Response to Command	Query (Instruction Code and Qualifier)	Response to Query
LNB LO Frequency	LLO=	6 bytes	<p>Command or Query. Sets or returns LNB Receive LO frequency in the form xxxxs, where: xxxxx = LO frequency, from 3000 to 65000 MHz (all 0's (000000) disables the feature) s = sign for the mix (high-side + or low-side - ) <b>Note:</b> Terminal Frequency = LNB LO <math>\pm</math> RFQ <b>Example:</b> &lt;0/LLO=06000+ (LO is 6 GHz, high-side mix)</p>	LLO= LLO? LLO* LLO#	LLO?	LLO=xxxxxs (see Description of Arguments)
LNB Power Control	LPC=	1 byte, value of 0 thru 2	<p>Command or Query. Sets or returns LNB Power Control in the form x, where 0 = Off 1 = On, 13V LNB Voltage 2 = On, 18V LNB Voltage <b>Example:</b> &lt;0/LPC=1 (LNB power is On, 13 volts)</p>	LPC= LPC? LPC* LPC#	LPC?	LPC=x (see Description of Arguments)



# Chapter 9. OPTIONAL PACKET PROCESSOR – SERIAL/TELNET CLI OPERATION

---

## 9.1 Overview

The Serial/Telnet CLI is a user menu system that allows configuration and monitor and control (M&C) of the CDM-570A/570AL Satellite Modem and its optional High-Performance Packet Processor through use of a user-supplied terminal emulator (e.g., HyperTerminal, TeraTerm, PuTTY, etc.) or Windows Telnet Client.



The CLI allows full configuration and M&C of the CDM-570A/570AL in addition to using the front panel menus or the CDM-570A HTTP (Web Server) Interface. See these chapters for further explanations of available modem operations:

- Chapter 6. FRONT PANEL OPERATION
- Chapter 7. ETHERNET-BASED REMOTE PRODUCT MANAGEMENT



Certain configuration menu selections (e.g., CnC) are functional only when that FAST feature has been purchased and enabled for operation. This chapter documents the CLI as if all available options are installed – your configuration may or may not provide the level of functionality as described in this chapter.

### 9.1.1 Access to the CLI

- **For Serial connection via a terminal emulator** – You must physically connect the User PC's 9-pin serial port to the RJ-11 **'Console'** port of the Packet Processor.

You must configure the user-supplied terminal emulator to match the 'Console' port settings.

See **Sect. 9.1.1.1** for further details.

- **For Ethernet connection via Telnet Client** – You must physically connect the User PC's RJ-45 Ethernet/Network Interface Card port to the modem Packet Processor. This connectivity can be via a local LAN using the modem's **'Ethernet 10/100 | Traffic 100'** or **'M&C 100'** BaseT Ethernet port, or remotely via a satellite link from another IP modem.

See **Sect. 9.1.1.2** for further details.

- **Serial or Telnet CLI User Access Levels** – Note the following:

CLI Interface	User Login Access Level
Serial CLI (using the RJ-11 'Console' port)	Full Access – NO LOGIN REQUIRED.
Telnet CLI (using the RJ-45 'Traffic 100' or 'M&C 100' port)	<ul style="list-style-type: none"> <li>• Admin User – <b>FULL ACCESS TO ALL MENUS.</b></li> <li>• Read/Write User – No access to the Administration menu; full access to all other menus.</li> <li>• Read Only User – <b>NO ACCESS PERMITTED.</b></li> </ul>

### 9.1.1.1 Connect to the Serial CLI

Do these steps:

1. Use an adapter cable such as the Comtech EF Data DB-9 to RJ-11 Console Cable (CEFD P/N PL/9396-1, available for purchase from Comtech EF Data Product Support) to connect the Packet Processor RJ-11 '**Console**' port to a 9-pin serial port on the User PC:

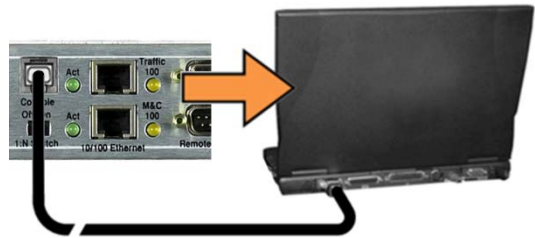

2. If you choose to use a terminal emulator program as your CLI portal, refer to your program's HELP feature or user guide for operating and configuration instructions. Default communications and terminal display settings are:
  - 38400 bps (Baud Rate)
  - 8 data bits
  - 1 stop bit
  - Parity = NO
  - Port Flow Control = NO
  - Local Echo = ON
  - Display New Line Rx/Tx: CR
3. Turn the modem **ON**. Once bootup is complete, press **Enter**. The CLI Main Menu should appear – **no login is required to use the Serial CLI**.
4. Use the CLI **Main Menu** ► **Interface Configuration** ► **Ethernet Interface** page to configure the Ethernet Traffic and Management IP Addresses. See **Sect. 9.3.3.1** for further details.

### 9.1.1.2 Connect to the Telnet CLI

Do these steps:

1. You must use an Ethernet hub, switch, or a direct CAT5 Ethernet cable connection to connect the User PC's RJ-45 Ethernet/Network Interface Card port to the Packet Processor 'Ethernet 10/100 | Traffic 100' or 'M&C 100' RJ-45 BaseT Ethernet port.



The 'M&C 100' port can be used only if the "Dedicated Management Port" option is 'Enabled'. See Sect. 9.3.3.1.1 for further details.

2. Turn the modem **ON**. Once bootup is complete, use Windows Command-line to "ping" the modem to confirm proper connection and communication between the User PC and the modem.
  - First, open a Command-line window...
    - For Windows 98, type "command" (or, for any Windows OS versions later than Windows 98, type "cmd" or "command"):

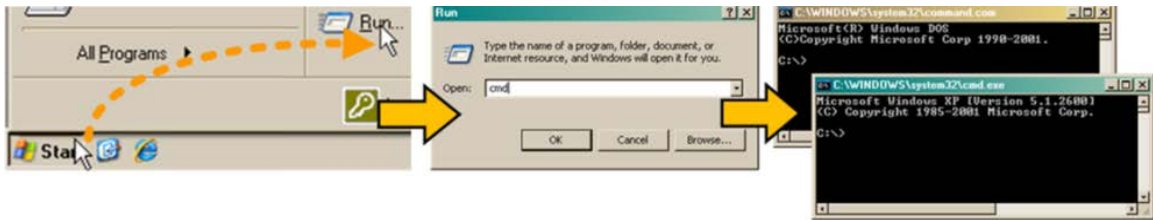

- Alternately, from [Start], select **All Programs > Accessories > Command Prompt**.
  - Then, from the Command-line prompt (c:\>), type "ping xxx.xxx.xxx.xxx" (where 'xxx.xxx.xxx.xxx' is the modem Traffic/Management IP Address). The response should confirm whether the unit is properly connected and communicating.
3. **As shown in Figure 9-1** – You may use the Windows Telnet Client to establish connectivity with the Packet Processor Telnet CLI. From the Command-line prompt (c:\>), type "telnet xxx.xxx.xxx.xxx" (where 'xxx.xxx.xxx.xxx' is the Traffic/Management IP Address).

You will be prompted for the User Name and Password. The factory defaults for user names/passwords are:

User Level	User Name/Password
Admin	comtech/comtech
Read/Write	opcenter/1234
Read Only	monitor/1234

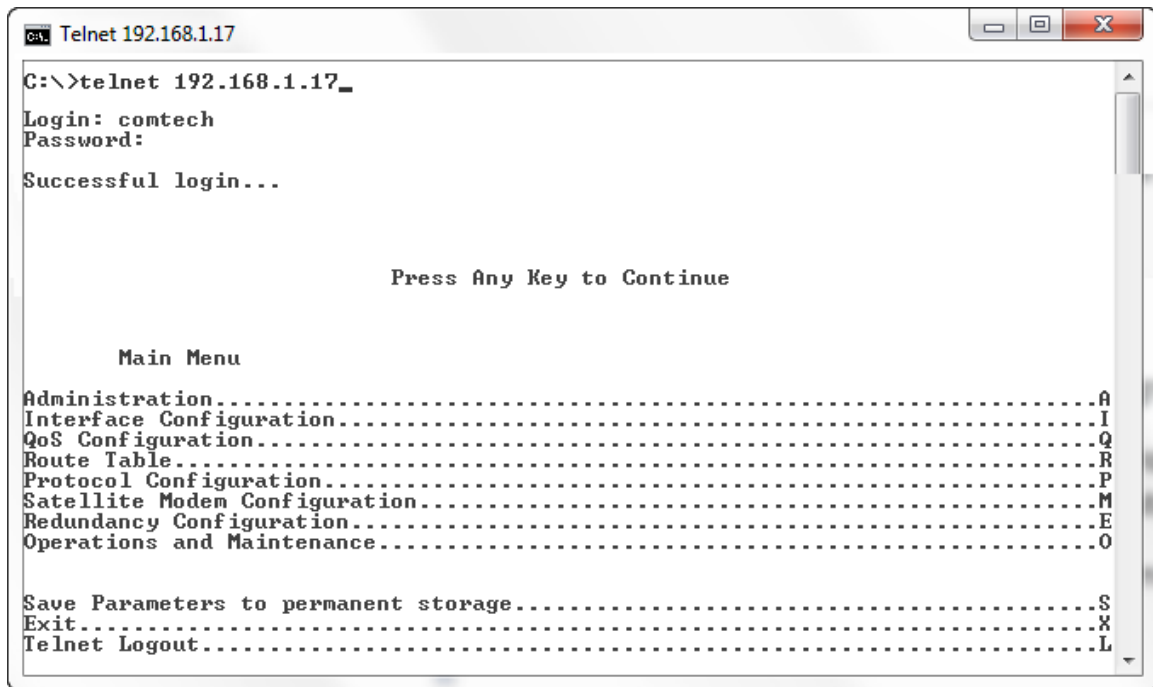

Figure 9-1. Login Using the Windows Telnet Client Program

4. Use the CLI **Main Menu** ► **Interface Configuration** ► **Ethernet Interface** page to configure the Ethernet Traffic and Management IP Addresses. See **Sect. 9.3.3.1** for further details.

## 9.2 Command Line Interface (CLI)



1. The Packet Processor does not allow concurrent access to the menu via Telnet and the 'Console' port. If you connect via Telnet, the Packet Processor automatically disables the 'Console' port for the duration of the Telnet session. All Telnet CLI menu pages allow a Telnet logout to end a Telnet session. Also, the Packet Processor automatically ends a Telnet session after a predefined period of inactivity (configurable from 1 to 60 minutes).
2. Any changes made to the base modem and Packet Processor will be lost if the Packet Processor is reset or loses power unless the changes are saved to permanent storage. This applies to all of the Packet Processor parameters. The parameters can be saved by selecting "S", available on any CLI/Telnet Menu page.
3. All parameters for the modem are stored in the Packet Processor parameter file. This provides a single file to store the entire configuration of the modem.
4. All base modem parameter changes (e.g., frequency, datarate, coderate etc) for the modem will be automatically saved by default. This applies to any changes made from the front panel or any other user interface (Web/CLI/SNMP, etc.).

## 9.2.1 CLI Menus – Common Navigation and Operation Features

The CLI organizes operation under a hierarchy of Configuration and Information functions. You may access any nested configuration or information page (e.g., Administration, Route Table, etc.) from this top-level menu by typing an available “Hot Key”.

The chapter subsections that follow provide “screen shots” of the available menu pages and a table detailing the available operational selections, the available Hot Keys, and a brief description of functionality for each screen item. The information for each menu page is tabulated, as per the above table, as follows:

- **Selection** – This is the function or command as it appears on the menu page.
- **Hot Key** – This is the letter or number assigned as the keystroke/mnemonic for execution of a menu function or command.

Where this column specifies **[RO]**, this means that this line item is a **read-only** (informational) feature. No user input is available.

- **Description** – This is the detailed explanation of the function or command. You are instructed to take a specific action here:
  - When you are instructed to “set” a feature, this means that you are prompted to type the numerical value for that feature. Press [Enter] to execute configuration. User guidance to “set” a value within a permitted range (from a minimum value to a maximum value) is commonly provided in parentheses or brackets.
  - When you are instructed to “select” a feature, this means that a numbered list of choices is commonly provided. Type the number to execute your operational selection. Press [Enter] to execute configuration.
  - When you are instructed to “toggle” a feature, this generally means that pressing the Hot Key executes one of two operating states for that feature (e.g., Enabled or Disabled, On or Off, Auto or Manual, etc.). The feature line will dynamically update to display, in brackets, its updated and current operating state.

- **Common Interface Options/Fields** – The bottom of each primary and nested page provides menu functions that are typical throughout the CLI:

Selection	Hot Key	Description
Save Parameters to permanent storage	S	Saves the current configuration of the Packet Processor to permanent storage. This configuration is restored on each successive power cycle.
Exit	X	Exits the current menu and returns to the parent menu. You may alternately press the <b>Esc</b> key to perform the same action.
Telnet Logout	L	<p>(TELNET CLI ONLY) When you press 'L', the modem terminates the Telnet session/exits the CLI, closes the terminal emulator application, and returns control to the serial interface.</p>  <ul style="list-style-type: none"> <li>• The Packet Processor does not allow concurrent access to the menu via Telnet and the 'Console' port. Upon connection via Telnet, the Packet Processor automatically disables the 'Console' port for the duration of the Telnet session.</li> <li>• All Telnet CLI pages provide the means to end/log out of a Telnet session.</li> <li>• The Packet Processor automatically ends a Telnet session after a predefined period of inactivity (configurable from 1 to 60 minutes).</li> </ul>

Except for **Figure 9-2**, the screen shots provided for the CLI through the remainder of this chapter exclude these functions for the purpose of brevity.

## 9.3 CLI Operations



Figure 9-2 show use of HyperTerminal as configured for Telnet CLI. The appearance of this interface may vary across individual user configurations. The remainder of this chapter shows the CLI pages as they appear with any user-supplied terminal emulator.

### 9.3.1 CLI Main Menu

```

Main Menu

Administration.....A
Interface Configuration.....I
QoS Configuration.....Q
Route Table.....R
Protocol Configuration.....P
Satellite Modem Configuration.....M
Redundancy Configuration.....E
Operations and Maintenance.....O

Save Parameters to permanent storage.....S
Exit.....X
Telnet Logout.....L
    
```

Figure 9-2. Main Menu

Selection	Hot Key	Description
Administration	A	Provides a basic set of standard administrative functions to the Packet Processor. When connected via Telnet, navigation to this menu is restricted to the Admin user. See Section 9.3.2.
Interface Configuration	I	Configures the Ethernet and Satellite interfaces. See Section 9.3.3.
QoS Configuration	Q	Defines QoS rules for up to 32 different types of flows. See Section 9.3.4.
Route Table	R	Defines how the Packet Processor will route packets that it receives on its Ethernet and Satellite interfaces. See Section 9.3.5.
Protocol Configuration	P	Configures various protocols – including ARP, IGMP, DHCP, and BRouter – used by the Packet Processor. See Section 9.3.6.
Vipersat Configuration	V	Only displays when the Vipersat option is installed. See Section 0.
Satellite Modem Configuration	M	Displays menus that are used to configure and monitor the Base Satellite Modem. See Section 9.3.8.
Redundancy Configuration	E	Configures 1:1 IP Redundancy.
Operations and Maintenance	O	Configures various options for system control and maintenance; provides Statistics and diagnostic tools for troubleshooting purposes.

### 9.3.2 Administration



Access to the Administration page is restricted to the Admin user when connecting via the Telnet CLI or HTTP interfaces. The Administration page is available via the Serial CLI connection because this interface requires no user login.

Open the Administration page from the Main Menu.

```

Administration
Name/Password Configuration.....P
Access Lists.....A
Feature Configuration.....F
3xDES Configuration.....D
SNMP Configuration.....N
Working Mode.....[Managed Switch].....C
Managed Switch Multicast Option.....[Disabled].....E
Header comp refresh rate <in pkts> for UDP/RTP1.....[50].....H
Header comp refresh rate <in pkts> for UDP.....[50].....U
Header comp refresh rate <in pkts> for all others.....[50].....O
Payload comp refresh rate <in pkts>.....[50].....Q
Telnet timeout.....[5].....T

Save Parameters to permanent storage.....S
Exit.....X
Telnet Logout.....L

```

**Figure 9-3. Administration**

Selection	Hot Key	Description
Name/Password Configuration	P	Use this page to define the User Name and Passwords that are required in order to access the management interfaces. See Section 9.3.2.1.
Access Lists	A	Use this page to restrict access to the management interfaces based upon the requester's IP address. See Section 9.3.2.2.
Feature Configuration	F	Use this page to access the Feature Configuration options. See Section 9.3.2.3.
3xDES Configuration	D	Use this page to access the 3xDEC Configuration options. See Section 9.3.2.4.
SNMP Configuration	N	Use this page to configure the SNMP Configuration options. See Section 9.3.2.5.
Working Mode	C	Use this page to set the Working Mode. See Appendix D for additional information. See Section 9.3.2.6.
Managed Switch Multicast Option	E	Select E to toggle [Enabled] or [Disabled]. See Section 9.3.2.7.
Header comp refresh rate (in pkts) for UDP/RTP1	H	See Section 9.3.2.8.
Header comp refresh rate (in pkts) for UDP	U	See Section 9.3.2.8.
Header comp refresh rate (in pkts) for all others	O	See Section 9.3.2.8.
Payload comp refresh rate (in pkts)	Q	See Section 9.3.2.9.
Telnet Timeout	T	See Section 9.3.2.10.



### 9.3.2.1 Administration > Name/Password Configuration

Open the nested Name/Password Configuration page from the Administration page.

Use this page to define the passwords required to access via HTTP, FTP, and Telnet.



Figure 9-4. Name/Password Configuration



- All Usernames and Passwords are case sensitive.
- There is a minimum of 1 and maximum of 11 characters.
- You may remove any or all of the Usernames and Passwords by typing “NONE NONE” after each selection.
- Removing all Usernames and Passwords allows access only to the IP functions when connecting via the Terminal Emulator serial connection (because there is no log in).
- FTP access is restricted to Admin Username/Password only. FTP is only used to update the Packet Processor firmware or to load or retrieve the IP Parameter or IP Event log files.

Selection	Hot Key	Description
Admin User/Password	A	Set the User Name and Password with a space delimiter. Example: <user> <password> Type NONE NONE to erase.
Read/Write User/Password	W	
Read Only User/Password	R	

### 9.3.2.2 Administration > Access Lists

Open the nested Access Lists page from the Administration page.

Use this page to limit monitor and control access to the unit from a specified list of authorized clients.

```

Access Lists
AccessClient1.....[NOT-DEFINED/NA].....1
AccessClient2.....[NOT-DEFINED/NA].....2
AccessClient3.....[NOT-DEFINED/NA].....3
AccessClient4.....[NOT-DEFINED/NA].....4
Access List Enforcement..[Disabled].....E

Save Parameters to permanent storage.....S
Exit.....X
Telnet Logout.....L

```

Figure 9-5. Access Lists



**If connecting to the IP modem remotely, be sure to include the IP address of the machine used to manage the IP modem in the Access List.**

Selection	Hot Key	Description
AccessClient1 – AccessClient4	1 – 4	<p>Defines which remote clients can connect when the Access List Enforcement is <b>Enabled</b>. Use each entry to specify an IP Address or a subnet mask to define a unique class of machines that are allowed access.</p> <p><b>For example</b>, to grant access to a PC with an IP Address of 10.10.10.1 and any PC on a subnet of 192.168.10.xxx, define the Access List as:</p> <pre> AccessClient1 ...[10.10.10.1/32] AccessClient2... [192.168.10.0/24] </pre>
Access List Enforcement	E	<p>Grants the defined list of client machines access via ping, Telnet, HTTP, FTP, and SNMP.</p> <p>Toggle <b>[Enabled]</b> or <b>[Disabled]</b>:</p> <ul style="list-style-type: none"> <li>• When <b>Enabled</b>, only those machines specified in the Access Client List are allowed to connect via ping, Telnet, HTTP, and SNMP.</li> <li>• When <b>Disabled</b>, any client machine is able to connect via ping, Telnet, HTTP, FTP, and SNMP.</li> </ul>

### 9.3.2.3 Administration > Feature Configuration

Open the nested Feature Configuration page from the Administration page.

```

Feature Configuration
Ping Reply.....[Enabled].....P
Telnet.....[Enabled]
SNMP.....[Enabled].....N
IGMP.....[Disabled].....I
Downlink Route All Available Multicast.....[Disabled].....M
Quality of Service (QoS).....[Disabled].....Q
Transmit 3xDES Encryption.....[Disabled].....T
Receive 3xDES Decryption.....[Available]
L3/L4/L5 Tx Header Compression.....[Disabled].....H
L3/L4/L5 Rx Header Compression.....[Disabled].....K
L2 Tx Header Compression.....[Disabled].....D
L2 Rx Header Compression.....[Disabled].....J
Tx Payload Compression.....[Disabled].....C
Rx Payload Compression.....[Available]
FAST Feature Code 1.....1
FAST Feature Code 2.....2
Uipersat Feature Codes.....[Available]
Uipersat Management.....[Disabled]
Uipersat File Streamer.....[Disabled]
LAN-to-LAN Routing.....[Disabled].....B
Payload Comp Type.....[ALDC]
Number of System Flows.....[20,000 <CDM-570 Compatibility Mode>]..F
RADIUS Configuration.....Y

Save Parameters to permanent storage.....S
Exit.....X
Telnet Logout.....L

```

Figure 9-6. Feature Configuration

The Feature Configuration page communicates the current availability for each of the features. If a feature is marked “Unavailable” then the item is a FAST feature.

Contact Comtech EF Data Product Support to purchase FAST features.

Selection	Hot Key	Description
Ping Reply	P	Toggle [Enabled] or [Disabled]: <ul style="list-style-type: none"> <li>When <b>Enabled</b>, the Packet Processor responds to ping requests directed to the Packet Processor Ethernet Interface.</li> <li>When <b>Disabled</b>, the Packet Processor does not respond to ping requests. Use this as a security feature to prevent unauthorized parties from determining if a device exists via the ping utility.</li> </ul>
Telnet	E	Toggle [Enabled] or [Disabled], only through the serial connection.
SNMP	N	Toggle [Enabled] or [Disabled]: <ul style="list-style-type: none"> <li>When <b>Enabled</b>, the Packet Processor responds to SNMP requests against the private and public MIB.</li> <li>When <b>Disabled</b>, the Packet Processor does not respond to SNMP requests against the private and public MIB.</li> </ul>

Selection	Hot Key	Description
IGMP	I	Use the IGMP protocol to regulate Multicast traffic on a LAN segment to prevent information of no interest from consuming bandwidth on the LAN.  Toggle <b>[Enabled]</b> or <b>[Disabled]</b> : <ul style="list-style-type: none"> <li>• When <b>Enabled</b>, the Packet Processor reports an interest to join a Multicast group on an IGMP server: <ul style="list-style-type: none"> <li>○ The receive portion of the Packet Processor is utilized as an IGMP server.</li> <li>○ The transmit portion of the Packet Processor is utilized as an IGMP client.</li> </ul> </li> </ul>
Downlink Route All Available Multicast	M	Toggle <b>[Enabled]</b> or <b>[Disabled]</b> : <ul style="list-style-type: none"> <li>• When <b>Enabled</b>, the Packet Processor routes all Multicast packets coming from the Satellite interface to the Ethernet LAN regardless of the Route Table entries.</li> <li>• When <b>Disabled</b>, the Packet Processor does not automatically forward all Multicast packets. The Packet Processor will forward Multicast traffic received from the satellite to the Ethernet port only if the Multicast route exists in the Route Table.</li> </ul>
Quality of Service (QoS)	Q	<b>This FAST feature must be purchased.</b>  Toggle <b>[Enabled]</b> or <b>[Disabled]</b> : <ul style="list-style-type: none"> <li>• When <b>Enabled</b>, the Packet Processor applies configured QoS rules on all packets going out the Satellite Interface.</li> <li>• When <b>Disabled</b>, the Packet Processor does not apply QoS rules for outgoing packets.</li> </ul>
Transmit 3xDES Encryption	T	Toggle <b>[Enabled]</b> or <b>[Disabled]</b>
Receive 3XDES Decryption	[RO]	This will show <b>[Available]</b> if the FAST feature was purchased on the unit.
L3/L4/L5 Tx Header Compression	H	Toggle <b>[Enabled]</b> or <b>[Disabled]</b> This option compresses L3/L4/L5 headers. Headers available for compression can be referenced in the IP Header Compression section.  Note that: <ul style="list-style-type: none"> <li>• In Managed Switch mode, all L2 Ethernet Headers are compressed whether or not this feature is <b>Enabled</b>.</li> <li>• In Router mode, this screen shows compression as <b>Available</b>, and the option must be <b>Enabled</b> per route using the Route Table page.</li> </ul>

Selection	Hot Key	Description
L3/L4/L5 Rx Header Compression	K	<p>Toggle <b>[Enabled]</b> or <b>[Disabled]</b></p> <p>This option tells the system to expect received streams to be Header compressed.</p> <p>A modem must receive all streams Header compressed or not Header compressed. The modem has no way to distinguish between compressed or not compressed. For this reason, when enabling Header Compression on a live satellite link, you must always first enable the option on the remote modem.</p> <p>If a modem has TX Header Compression <b>Enabled</b>, the receiving modem will not be able to receive any data unless RX Header Compression is also <b>Enabled</b>.</p> <p><b>For example:</b>  <b>Step 1.</b> Enable remote modem TX Header Comp (data link will be lost).  <b>Step 2.</b> Enable local modem RX Header Compression (data link will be restored).  <b>Step 3.</b> Enable remote modem RX Header Comp (data link will be lost).  <b>Step 4.</b> Enable local modem TX Header Compression (data link will be restored).</p>
Tx Payload Compression	C	<p>Toggle <b>[Enabled]</b> or <b>[Disabled]</b></p> <p>Allows a stream of traffic to be payload compressed. Payload is considered everything inside the HDLC satellite frame; therefore, IP headers could be compressed as well.</p> <p>Note that:</p> <ul style="list-style-type: none"> <li>• In Managed Switch Mode, the option is <b>Enabled</b> or <b>Disabled</b> for all traffic.</li> <li>• In Router mode, Payload compression displays as <b>Available</b>, and you must set the option Per Route in Routing table.</li> </ul>
Rx Payload Compression	[RO]	This option is always <b>Available</b> when purchased and activated. It is auto-sensed by a bit carried in packet headers. Rx Payload Compression allows a unit receiving a stream of data that has been payload compressed to be correctly uncompressed.
FAST Feature Code 1	1	When you purchase a Register 1-specific FAST option, set the FAST Access Code here to activate your purchase.
FAST Feature Code 2	2	When you purchase a Register 2-specific FAST option, set the FAST Access Code here to activate your purchase.
Vipersat Feature Codes	[RO]	Displays the Vipersat features enable code that has been provided by Comtech Vipersat for the modem configured to operate under VMS control.
Vipersat Management	[RO]	 <p>VMS v3.x.x VIPERSAT Management System User Guide (CEFD P/N MN/22156)</p>
Vipersat File Streamer	[RO]	

Selection	Hot Key	Description
LAN-to-LAN Routing	B	Toggle as [Enabled] or [Disabled].  In response to the prompt, "Configuring LAN-to-LAN Routing disable the ICMP redirect Messages. Do you want to continue (Y/N) [Enter :No]"  Type Y to enable. Otherwise, press [Enter] to maintain this feature as disabled.
Payload Comp Type	[RO]	This feature is fixed, at present, to display ALDC (Adaptive Lossless Data Compression) as the sole and default payload compression type. Future firmware versions will allow the use of Hot Key 'A' for toggling between ALDC and other available compression types.
Number of System Flows	F	In response to the prompt, "System Flows should match with peer modem's Config. Do you want to continue (Y/N) [Enter :No]"  Type 'Y' to toggle between 20,000 (CDM-570 Compatibility Mode) or 64,000. Otherwise, press [Enter] to maintain this feature as configured.
RADIUS Configuration	Y	Select to enter the RADIUS Configuration. See Section 9.3.2.3.1.

### 9.3.2.3.1 Administration > Feature Configuration >RADIUS Configuration

```

                                RADIUS
RADIUS Client.....[Disabled].....E
Server Password Type.....[PAP].....T
Primary Server IP Address.....[NOT-DEFINED].....1
Secondary Server IP Address...[NOT-DEF'NED].....2
Server Shared Secret.....[*****].....C
Server Port.....[1812].....P

Save Parameters to permanent storage.....S
Exit.....X
Telnet Logout.....L

```

**Figure 9-7. RADIUS Configuration**

Selection	Hot Key	Description
RADIUS Client	E	Toggle [Enabled] or [Disabled]:
Server Password Type	T	Toggle to select [PAP] or [CHAP]
Primary Server IP Address	1	Select to enter the Primary Server IP Address.
Secondary Server IP Address	2	Select to enter the Secondary Server IP Address.
Server Shared Secret	C	Select to enter the Server Shared Secret.
Server Port	P	Select to enter the Server Port.

### 9.3.2.4 Administration > 3xDES Configuration

Open the nested 3xDES Configuration page from the Administration page.

```

Triple DES Encrypt/Decrypt Configuration

3xDES Status.....[Available]
Tx Encrypt Enabled..[Enabled]
Rx Decrypt Enabled..[Available]
Transmit Key 1.....[2222222222222222 4444444444444444 6666666666666666 ].....1
Transmit Key 2.....[2222222222222222 4444444444444444 6666666666666666 ].....2
Transmit Key 3.....[2222222222222222 4444444444444444 6666666666666666 ].....3
Transmit Key 4.....[2222222222222222 4444444444444444 6666666666666666 ].....4
Transmit Key 5.....[2222222222222222 4444444444444444 6666666666666666 ].....5
Transmit Key 6.....[2222222222222222 4444444444444444 6666666666666666 ].....6
Transmit Key 7.....[2222222222222222 4444444444444444 6666666666666666 ].....7
Transmit Key 8.....[2222222222222222 4444444444444444 6666666666666666 ].....8
Receive Key 1.....[2222222222222222 4444444444444444 6666666666666666 ].....A
Receive Key 2.....[2222222222222222 4444444444444444 6666666666666666 ].....B
Receive Key 3.....[2222222222222222 4444444444444444 6666666666666666 ].....C
Receive Key 4.....[2222222222222222 4444444444444444 6666666666666666 ].....D
Receive Key 5.....[2222222222222222 4444444444444444 6666666666666666 ].....E
Receive Key 6.....[2222222222222222 4444444444444444 6666666666666666 ].....F
Receive Key 7.....[2222222222222222 4444444444444444 6666666666666666 ].....G
Receive Key 8.....[2222222222222222 4444444444444444 6666666666666666 ].....H

Save Parameters to permanent storage.....S
Exit.....X
Telnet Logout.....L

```

Figure 9-8. 3xDES Configuration

Use the 3xDES Configuration page to configure the Triple DES encryption/decryption keys.

### 9.3.2.5 Administration > SNMP Configuration

Open the nested SNMP Configuration page from the Administration page.

```

SNMP Configuration

SNMP Read Community.....[public].....R
SNMP Write Community.....[private].....W
SNMP Trap Community.....[contech].....T
SNMP Trap Destination #1.....[NOT-DEFINED].....D
SNMP Trap Destination #2.....[NOT-DEFINED].....2
SNMP Trap Version.....[SNMPv1].....U
SNMP Enable Authentication Trap..[Enabled].....A
SNMP System Contact.....[].....C
SNMP System Name.....[].....N
SNMP System Location.....[].....O

Save Parameters to permanent storage.....S
Exit.....X
Telnet Logout.....L

```

Figure 9-9. SNMP Configuration

Selection	Hot Key	Description
SNMP Read Community	R	Select to enter community string (20 characters max).
SNMP Write Community	W	Select to enter community string (20 characters max).
SNMP Trap Community	T	Select to enter community string (20 characters max).
SNMP Trap Destination #1	D	Select to enter a value for the SNMP Trap Destination #1. Enter the IP address in aaa.bbb.ccc.ddd format.
SNMP Trap Destination # 2	2	Select to enter a value for the SNMP Trap Destination #2. Enter the IP address in aaa.bbb.ccc.ddd format.
SNMP Trap Version	V	Select to toggle between [SNMPv1] and [SNMPv2].
SNMP Enable Authentication Trap	A	Select to toggle [Enabled] or [Disabled]:
SNMP System Contact	C	Select to enter text.
SNMP System Name	N	Select to enter text.
SNMP System Location	O	Select to enter text.

### 9.3.2.6 Administration > Working Mode



See Appendix D.



1. When you select Hot Key 'C' you are first prompted with:

**“Changing Modem working mode requires system Reboot.**

**Do you want to continue (Y/N)[Enter :No]”**

**Press Y to continue; otherwise press N, [Enter], or [Esc] to quit and return to the Administration page.**

2. Working Mode is disabled when Brouter Mode VLAN Filtering is enabled. If you attempt to select this item while configured as such, the following error message displays:

**“Can’t change Modem Working Mode when Brouter VLAN Filter is Enabled”**

Once you elect to continue with configuration, you are prompted to select the active Working Mode:

Selection	Description
1 – Router – Small Network	Router uses 1 byte HDLC addresses
2 – Router – Large Network	Router mode using 2 byte HDLC addresses
3 – Router – Point to Point	Router mode uses 0 HDLC addresses to save satellite bandwidth
4 – Router – Vipersat	Router mode when running in a Vipersat Network
5 – Managed Switch	Default operating mode, and operates at 10/100BaseT. In this mode the Packet Processor will forward both IP and non-IP datagrams over satellite without any defined routes.



---

### 9.3.2.7 Administration > Managed Switch Multicast Option



**If the Working Mode is Managed Switch and Multicast traffic is intended to pass across a pair of modems, this option must be enabled on both modems.**

The Managed Switch Multicast Option allows Multicast to be either transmitted or received through the modem. This applies to **Managed Switch Mode** only. Managed Switch Mode will normally filter Multicast traffic.

---

### 9.3.2.8 Administration > Header Compression Refresh Rates



**Managed Switch Mode automatically uses L2 Header Compression (even if the Header Compression option has not been purchased). Because of this, some of the initial traffic sent between two devices is not received over the satellite until a full Header is transmitted. For example, the default Header Compression Refresh Rate is 50 packets. When a ping is sent over the satellite, it times out until the full Header packet is sent. The Header Compression Refresh Rate on the Administration page can be reduced to minimize the amount of traffic lost when traffic is first sent between two devices. Once communication between two devices has been established, both modems are able to receive all traffic, unless one modem is power cycled or reset.**

The Header Compression Refresh Rates are configured from the Administration page when Header Compression is **Enabled**.

The Header Compression Refresh Rates determines how many compressed header packets are sent before a single full header packet is sent. Some compressed header traffic could be lost during deteriorated satellite link conditions. Sending a full header packet will allow the return of the traffic stream.

The Refresh Rate can be decreased for poor satellite link conditions, or increased to further reduce overhead.

You may select refresh rates, from 1 to 600, individually for UDP/RTP1, UDP, or all other IP headers.

The default rate of 50 provides the best performance and efficiency for typical satellite links.

---

### 9.3.2.9 Administration > Payload Compression Refresh Rate

The Payload Compression Refresh Rates determines how many compressed payload packets are sent before a single full payload packet is sent. Some compressed payload traffic could be lost during deteriorated satellite link conditions. Sending a full payload packet will allow the return of the traffic stream.

You may select a Refresh Rate from 1 to 600. The Refresh Rate can be decreased for poor satellite link conditions or increased to further reduce overhead.

---

### 9.3.2.10 Administration > Telnet Timeout



**The Packet Processor does not allow concurrent access to the CLI via Telnet and the 'Console' port. If you connect via Telnet, the Packet Processor automatically disables the 'Console' port for the duration of the Telnet session. You may use Hot Key 'L' (Telnet Logout) from any CLI page to end a Telnet session.**

You may configure the Packet Processor to automatically end a Telnet session after a specified period of inactivity (configurable from 1 to 60 minutes).

### 9.3.3 Interface Configuration

Open the Interface Configuration page from the Main Menu.



Figure 9-10. Interface Configuration

Selection	Hot Key	Description
Ethernet Interface	E	Displays the Ethernet Interface page.  See Sect. 9.3.3.1.1 for the Ethernet Interface page when in Managed Switch Mode, and Sect. 9.3.3.1.2 for the Ethernet Interface page when in Router Mode.
Satellite/HDLC Interface	H	Displays the Satellite/HDLC Interface page.

#### 9.3.3.1 Interface Configuration > Ethernet Interface

Open the Ethernet Interface page from the Interface Configuration page. Note that selections differ based on the active Working Mode – Managed Switch or Router Mode (see **Sect. 9.3.2**).

### 9.3.3.1.1 Interface Configuration > Ethernet Interface (Managed Switch Mode)

```

                                Ethernet Interface
MAC Address.....[00-06-B0-00-02-3A]
Traffic Port Speed/Mode.....[Auto].....E
IP Address.....[192.168.21.101].....I
Subnet Prefix Length.....[ 24 ].....M
DM/Red Traffic MAC Address.....[00-06-B0-00-02-3A]
Traffic Port Actual Speed.....[100 Mb/sec Full Duplex]
Managed Switch MAC Learning.....[Enabled].....A
Managed Switch Gateway IP.....[31.41.51.61].....G
Dedicated Management Port.....[Disabled].....D
ULAN.....[Disabled].....U
ULAN Table.....T

Save Parameters to permanent storage.....S
Exit.....X
d

Please enter a value for the Dedicated Management Port
Press ESC to abort
  1 -- Disabled
  2 -- Local ONLY Mode
  3 -- Local & Remote Mode
  █

```

```

                                Ethernet Interface
Mgmt MAC Address.....[00-06-B0-05-70-3B]
Traffic Port Speed/Mode.....[Auto].....E
Mgmt IP Address.....[192.168.21.101].....I
Mgmt Subnet Prefix Length.....[ 24 ].....M
DM/Red Traffic MAC Address.....[00-06-B0-00-02-3A]
Traffic Port Actual Speed.....[100 Mb/sec Full Duplex]
Managed Switch MAC Learning.....[Enabled].....A
Managed Switch Gateway IP.....[31.41.51.61].....G
Dedicated Management Port.....[Local ONLY Mode].....D
ULAN.....[Disabled].....U
ULAN Table.....T

```

```

                                Ethernet Interface
Mgmt MAC Address.....[00-06-B0-05-70-3B]
Traffic Port Speed/Mode.....[Auto].....E
Mgmt IP Address.....[192.168.21.101].....I
Mgmt Subnet Prefix Length.....[ 24 ].....M
DM/Red Traffic MAC Address.....[00-06-B0-00-02-3A]
Traffic Port Actual Speed.....[100 Mb/sec Full Duplex]
Managed Switch MAC Learning.....[Enabled].....A
Managed Switch Gateway IP.....[31.41.51.61].....G
Dedicated Management Port.....[Local & Remote Mode].....D
ULAN.....[Disabled].....U
ULAN Table.....T

```

(TOP) Dedicated Management Port = DISABLED, Hot Key 'D' selected  
 (CENTER) Dedicated Management Port = Local ONLY Mode  
 (BOTTOM) Dedicated Management Port = Local & Remote Mode

Figure 9-11. Ethernet Interface in Managed Switch Mode



**You must set the Traffic Port Speed/Mode to match the Ethernet port settings of the connected device port to avoid experiencing significant performance degradation.**

**For example, if the connected device port is set for Auto Negotiate, then you must also set the Packet Processor to Auto Negotiate. Comtech EF Data recommends that you use Auto Negotiate mode, unless the connected device port does not support Auto Negotiate. In such cases, both Ethernet ports must be set to the same Manual settings (i.e., 100 Mbps Full Duplex).**

Selection	Hot Key	Description
Mgmt MAC Address	[RO]	This is the hardware destination MAC Address that is used when an Ethernet packet is destined for the Packet Processor M&C Ethernet Interface. This address is unique and has been assigned permanently at the factory.
Traffic Port Speed/Mode	E	This is a configurable parameter and, as such, its exact setting can vary between specific installations. The default setting allows the Ethernet port to auto-negotiate its link speed on power-up. Selections are: 1 – Auto (default) 2 – 10 MB/sec Half Duplex 3 – 100 MB/sec Half Duplex 4 – 10 MB/sec Full Duplex 5 – 100 MB/sec Full Duplex
Mgmt IP Address	I	Select this to assign the IP Address for the Ethernet M&C Interface. Set the IP address in aaa.bbb.ccc.ddd format
Subnet Prefix Length	M	Select this to define the Subnet Mask assigned to the Ethernet Traffic Interface. Set the subnet mask prefix length (8...30)
DM/Red Traffic MAC Address	[RO]	This is the hardware destination MAC Address that is used when an Ethernet packet is destined for the Packet Processor Traffic Ethernet Interface. This address is unique and has been assigned permanently at the factory.
Traffic Port Actual Speed	[RO]	This displays the current speed and duplex of the Packet Processor Traffic port.
Managed Switch MAC Learning	A	Select this to disable MAC Learning on packets received on the Ethernet Interface, so that all packets are sent to the satellite.
Managed Switch Gateway IP	G	Select this to define a Gateway so that the Packet Processor is accessible from an outside network when in Managed Switch Mode
Dedicated Management Port	D	Select this to disable or enable Dedicated Management Port operation. <b>When Working Mode = Managed Switch, selections are:</b> 1 – Disabled (default) 2 – Local ONLY mode 3 – Local & Remote Mode  <b>Appendix Q. DEDICATED MANAGEMENT PORT FEATURE</b>
VLAN	V	Select this to enable VLAN support functions
VLAN Table	T	Select this to create VLAN Table entries – see Sect. 9.3.3.1.1.1

### 9.3.3.1.1.1 Interface Configuration > Ethernet Interface > VLAN Table

Open the nested VLAN Table from the Ethernet Interface page (Managed Switch Mode only).

VLAN Table				
ID	Name	Tag	Priority	
VLAN01	[ 1 native	native	1]	1
VLAN02	[ 1 management	management	1]	2
VLAN03	[1794 Web	tagged	N/A]	3
VLAN04	[1818 Data	tagged	N/A]	4
VLAN05	[2105 Voice	tagged	N/A]	5
VLAN06	[UNKNOWN]			6
VLAN07	[UNKNOWN]			7
VLAN08	[UNKNOWN]			8
Delete VLAN Entry				D
Base	[1]			B

Figure 9-12. VLAN Table

Selection	Hot Key	Description
VLAN01 – VLAN08	1 – 8	Type a VLAN ID (1 through 4094).
Delete VLAN Entry	D	Set the VLAN Entry number (1 to 8) to delete that entry from the table.
Base [#]	B	Select Base and then type a number to display or edit a different set of eight of up to 4093 definable VLAN ID entries. <b>Example 1</b> – If you have eight existing VLAN entries: Type '9' to create a new VLAN ID 9. The VLAN Table page will refresh and now display VLAN Entries 9-16. <b>Example 2</b> – If you want to edit VLAN IDs 32-40: Type 'B', and then type '32' to select the Base value of 32. The VLAN Table page will refresh to display VLAN IDs 32 through 40.

In the default VLAN Table, **Figure 9-12** shows where there is a **Native VLAN** and a **Management VLAN** (default VLAN ID 1). These can be changed to other VLAN IDs, but they cannot be deleted.

If an untagged packet arrives at the Packet Processor, it will egress as a tagged packet with the defined Native VLAN ID.

You may add VLAN entries into the VLAN Table, and forward VLANs over the satellite. You also need a VLAN entry on the receiving CDM-570A/570AL to receive the VLAN traffic – they will egress as tagged VLANs.

When a tagged packet arrives at the Ethernet port, it is forwarded only if there is a matching VLAN entry in the VLAN Table; it will egress as tagged. If there is no matching VLAN in the VLAN Table, then the tagged packet is dropped.

### 9.3.3.1.2 Ethernet Interface (Router Mode)

```

                                Ethernet Interface

Mgmt MAC Address.....[00-06-B0-00-02-3A]
Traffic Port Speed/Mode.....[Auto].....E
Mgmt IP Address.....[192.168.21.101].....I
Mgmt Subnet Prefix Length.....[ 24 ].....M
DM/Red Traffic MAC Address.....[00-06-B0-00-02-3A]
DM/Red Traffic IP Addr.....[192.168.21.101].....L
DM/Red Traffic Subnet Prefix.....[ 24 ].....B
Traffic Port Actual Speed.....[100 Mb/sec Full Duplex]
Managed Switch Gateway IP.....[31.41.51.61].....G
Dedicated Management Port.....[Disabled].....D

Save Parameters to permanent storage.....S
Exit.....X
d

Please enter a value for the Dedicated Management Port
Press ESC to abort
  1 -- Disabled
  2 -- Enabled
  
```

```

                                Ethernet Interface

Mgmt MAC Address.....[00-06-B0-05-70-3B]
Traffic Port Speed/Mode.....[Auto].....E
Mgmt IP Address.....[192.168.21.101].....I
Mgmt Subnet Prefix Length.....[ 24 ].....M
DM/Red Traffic MAC Address.....[00-06-B0-00-02-3A]
DM/Red Traffic IP Addr.....[192.168.111.101].....L
DM/Red Traffic Subnet Prefix.....[ 24 ].....B
Traffic Port Actual Speed.....[100 Mb/sec Full Duplex]
Managed Switch Gateway IP.....[31.41.51.61].....G
Dedicated Management Port.....[Enabled].....D

Save Parameters to permanent storage.....S
Exit.....X
  
```

(TOP) Dedicated Management Port = DISABLED  
(BOTTOM) Dedicated Management Port = ENABLED

Figure 9-13. Ethernet Interface in Router Mode



**You must set the Traffic Port Speed/Mode to match the Ethernet port settings of the connected device port to avoid experiencing significant performance degradation.**

**For example, if the connected device port is set for Auto Negotiate, then you must also set the Packet Processor to Auto Negotiate. Comtech EF Data recommends that you use Auto Negotiate mode, unless the connected device port does not support Auto Negotiate. In such cases, both Ethernet ports must be set to the same Manual settings (i.e., 100 Mbps Full Duplex).**

Selection	Hot Key	Description
Mgmt MAC Address	[RO]	This is the hardware destination MAC Address that is used when an Ethernet packet is destined for the Packet Processor M&C Ethernet Interface. This address is unique and has been assigned permanently at the factory.
Traffic Port Speed/Mode	E	This is a configurable parameter and, as such, its exact setting can vary between specific installations. The default setting allows the Ethernet port to auto-negotiate its link speed on power-up. Selections are: 1 – Auto (default) 2 – 10 MB/sec Half Duplex 3 – 100 MB/sec Half Duplex 4 – 10 MB/sec Full Duplex 5 – 100 MB/sec Full Duplex
Mgmt IP Address	I	Select this to assign the IP Address for the Ethernet M&C Interface. Set the IP address in aaa.bbb.ccc.ddd format
Subnet Prefix Length	M	Select this to define the Subnet Mask assigned to the Ethernet Traffic Interface. Set the subnet mask prefix length (8...30)
DM/Red Traffic MAC Address	[RO]	This is the hardware destination MAC Address that is used when an Ethernet packet is destined for the Packet Processor Traffic Ethernet Interface. This address is unique and has been assigned permanently at the factory.
DM/Red Traffic IP Addr		In Managed Switch Mode, this entry is not applicable. In Router mode this parameter can be configured when either Redundancy is Enabled Or Dedicated Management Port is Enabled.
DM/Red Traffic Subnet Prefix		In Managed Switch Mode, this entry is not applicable. In Router mode, this parameter can be configured when either Redundancy is Enabled Or Dedicated Management Port is Enabled.
Traffic Port Actual Speed	[RO]	This displays the current speed and duplex of the Packet Processor Traffic port.
Dedicated Management Port	D	Select this to disable or enable Dedicated Management Port operation. <b>When Working Mode = Router, selections are:</b> 1 – Disabled (default) 2 – Enabled



### 9.3.3.2 Interface Configuration > Satellite/HDLC Interface

Open the nested Satellite/HDLC Interface page from the Interface Configuration page.

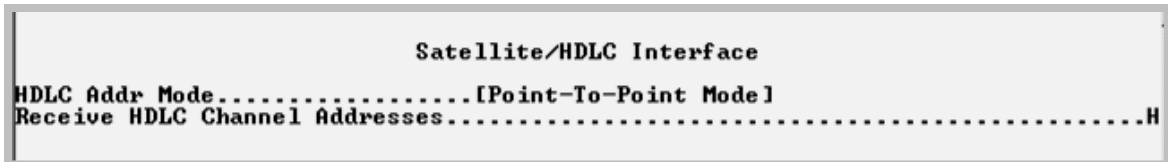

Figure 9-14. Satellite/HDLC Interface

Selection	Hot Key	Description
HDLC Addr Mode	[RO]	<ul style="list-style-type: none"> <li>• <b>HDLC Address Mode</b> – This mode is configured via the <b>Working Mode</b>, which is found on the Administration page.</li> <li>• <b>Point-To-Point Mode</b> – In this mode of operation, no HDLC address is transmitted over the satellite link. The restrictions on using this mode are that it can only be used for pure Point-to-Point configurations.</li> <li>• <b>Small Network Mode (up to 254 addresses)</b> – In this mode of operation a single byte HDLC address is transmitted over the satellite link (0x1 – 0xFE).</li> <li>• <b>Large Network Mode (up to 32766 addresses)</b> – In this mode of operation a two byte HDLC address is transmitted over the satellite link (0x1 – 0xFFFE).</li> </ul>
Receive HDLC Channel Addresses	H	Displays the Receiver HDLC Channel Addresses page.

### 9.3.3.3 Interface Configuration > Receive HDLC Channel Addresses

Open the nested Receive HDLC Channel Addresses page from the Satellite/HDLC Interface page. Use this page to define up to four HDLC addresses that can carry user information on the Satellite Interface.

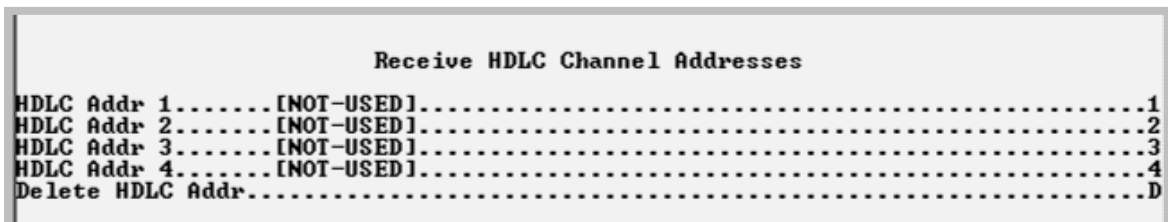

Figure 9-15. Receive HDLC Channel Addresses

Selection	Hot Key	Description
HDLC Addr 1 – HDLC Addr 4	1 – 4	HDLC address in hex <1 – FFFE, enter = 0001> Note that HDLC addresses are not used in Point-To-Point Mode. <ul style="list-style-type: none"> <li>• <b>Small Network Mode (up to 254 addresses)</b> – Limited to valid addresses between the values of 0x01 and 0xFE.</li> <li>• <b>Large Network Mode (up to 32766 addresses)</b> – Limited to valid addresses between the values of 0x0001 and 0x7FFF.</li> </ul>
Delete HDLC Addr	D	Set the HDLC entry to delete <1...4>

### 9.3.4 QoS (Quality of Service) Configuration

Open the QoS Configuration page from the Main Menu.

```

QoS Configuration
QoS Mode.....[Rule-Max/Pri Mode].....M
QoS Rules Configuration.....Q
DiffServ Rules Configuration.....D
Typical System Latency (msecs).....[5000].....A
Enable WAN Segmentation and Reassembly (SAR)..[Enabled].....R
    
```

**Figure 9-16. QoS Configuration**

Selection	Hot Key	Description
QoS Mode	M	Select: 1 – Rule-Max/Pri Mode 2 – Rule-Min/Max Mode 3 – DiffServ Mode 4 – VLAN Priority/Max Mode
QoS Rules Configuration	Q	Defines QoS rules for Max/Pri Mode or Min/Max Mode. See Section 9.3.4.1.
DiffServ Rules Configuration	D	Defines QoS rules for DiffServ Mode. See Section 9.3.4.2.
Maximum System Latency (msecs)	A	Select this to specify the maximum depth of the QoS queue, from 200 to 5000 milliseconds of traffic that is destined to go over the satellite. This defines the maximum duration that a packet will sit in a QoS queue before being aged out and dropped. Lower priority packets are dropped first until there is enough room to send the higher priority packets.
Enable WAN Segmentation and Reassembly (SAR)	R	Toggle Packet Segmentation and Reassembly (SAR) as <b>Enabled</b> or <b>Disabled</b> .  SAR is automatically <b>Enabled</b> while QoS is <b>Enabled</b> . However, SAR is an adaptive process; it will trigger only if the packet latency exceeds the threshold value (default to 20 msecs). Latency value is calculated based on the satellite transmission bandwidth. There is no minimum segment size; however, if the last segment is less than 16 bytes, then it is appended to the previous segment – excluding satellite HDLC header – in order to avoid satellite overhead and consumption of CPU cycles.

### 9.3.4.1 QoS Configuration > QoS Rules Configuration

#### 9.3.4.1.1 QoS Rules Configuration (Max/Priority Mode)

Open the nested QoS Rules Configuration page from the QoS Configuration page.

QoS Rules Configuration							
SrcIP	DestIP	Prot	SPort	DPort	MaxBW	PWF	
RL01.. [10.6.20.32/30	***/*	RTP	1155 ~1180	1155 ~1180	512	1YN	1.1
RL02.. [ ***/*	12.6.50.2/32	pFTP	***	***	256	2YN	1.2
RL03.. [10.6.20.0/24	***/*	HTTP	***	***	384	3YN	1.3
RL04.. [10.6.20.0/24	12.6.50.0/24	SMTP	***	***	32	5YN	1.4
RL05.. [10.6.20.5/32	12.6.50.0/24	UDP	*** ***	161 ~161	32	2YN	1.5
RL06.. [ ***/*	239.240.65.8/32	UDP	***	***	512	2YN	1.6
RL07.. [10.6.20.128/29	***/*	IP	***	***	99999	8YY	1.7
RL08.. [UNKNOWN]	.....	.....	.....	.....	.....	.....	8
Def... [ ***/*	***/*	ALL	***	***	99999	9NN	1.8
[ P-Priority	W-WRED<Yes/No>	F-Filter<Yes/No>				]	
Del.....	.....						D
Base.. [1]	.....						B
QoS... [	QoS Enabled				]		

Figure 9-17. QoS Rules Configuration (Max/Priority Mode)

Selection	Hot Key	Description
RL01 through RL32 (The current eight of up to 32 definable QoS Rules).	1 – 8	Assign Max/Pri QoS to up to 32 different types of definable flows. Define flows by any combination of Protocol, Priority, Source/Destination IP Addresses (specific or range), and/or Layer 3 Source and Destination Ports.  FOR RULE ASSIGNMENT OR EDIT PROCESS, SEE "Assign or Edit a QoS Rule"
Delete	D	Set the QoS Rule to delete, from 1 to 32.
Base [#]	B	Select Base to display or edit a different group of eight of up to 32 QoS Rules.  For example, if you want to edit QoS Rule 9: Type 'B', and then type '9' to select the Base value of 9. The QoS Rules Configuration page will refresh to display RL09 through RL16.
QoS [ ]	[RO]	This line displays state of the QoS option as <b>Unavailable</b> , <b>Enabled</b> , or <b>Disabled</b> . If available, QoS is <b>Enabled</b> or <b>Disabled</b> from the Administrator Features page.

### Assign or Edit a QoS Rule

When you select a rule to create or edit (Hot Key 1 through 8), the CLI prompts you to assign parameters in this order:

Screen Prompt	Action
Specify Protocol for the rule	Specify your desired rule protocol: 1 for UDP (User Datagram Protocol) 2 for TCP (Transmission Control Protocol) 3 for ICMP (Internet Control Message Protocol) 4 for RTP (Real Time Protocol (includes all RTP – VOCE, VDEO, and RTPS)) 5 for VOCE (Voice RTP) 6 for VDEO (Video RTP) 7 for RTPS (RTP Signaling) 8 for FTP (File Transfer Protocol only) 9 for HTTP (Hypertext Transfer Protocol) 10 for TELN (Telnet) 11 for SMPT (Simple Mail Transfer Protocol) 12 for SNMP (Network Management Protocol) 13 for SAP (Service Announcement Protocol) 14 for ORCL (Oracle application traffic) 15 for CTRX (Citrix application traffic) 16 for SQL (Structured Query Language) 17 for IP (Internet Protocol (all inclusive)) 18 for N-IP (Non-Internet Protocol (all inclusive))
Specify priority for the rule	Where Priority 1 = Highest, and Priority 8 = Lowest: 1 for QoS Priority-1 2 for QoS Priority-2 3 for QoS Priority-3 4 for QoS Priority-4 5 for QoS Priority-5 6 for QoS Priority-6 7 for QoS Priority-7 8 for QoS Priority-8
Maximum bandwidth in kbps <0-99999, enter = 99999>:	Type your Maximum Bandwidth, in kbps, from 0 to 99999. If you desire no such parameter, press [Enter] – the bandwidth defaults to '99999'.
Source IP address <enter = 0.0.0.0>:	Type your Source IP Address in the form XXX.XXX.XXX.XXX. If you desire no Source IP Address, press [Enter] – the address displays as '***'.
Number of Source subnet bits <0,8-32, enter = 0>:	Type your Source subnet bits value, from 8 to 32. If you desire no Source subnet. type '0' or press [Enter] – the subnet displays as '/'.
Destination IP address <enter = 0.0.0.0>:	Type your Destination IP Address in the form XXX.XXX.XXX.XXX. If you desire no Destination IP Address, press [Enter] – the address displays as '***'.
Number of Destination subnet bits <0,8-32, enter = 0>:	Type your Destination subnet bits value, from 8 to 32. If you desire no Destination subnet. type '0' or press [Enter] – the subnet displays as '/'.
Specify TCP/UDP source port [MIN] (1-65535) <Enter: ***>	Set the minimum TCP/UDP source port in your range, from 1 to 65535. If you desire no minimum TCP/UDP source port, press [Enter] – the port displays as '***'.
Specify TCP/UDP source port [MAX] (1-65535) <Enter: ***>	<b>This prompt will not display if you do not select a MIN TCP/UDP source port.</b> Set the maximum TCP/UDP source port in your range, from 1 to 65535.
Specify TCP/UDP destination port [MIN] (1-65535) <Enter: ***>	Set the minimum TCP/UDP destination port in your range, from 1 to 65535. If you desire no minimum TCP/UDP destination port, press [Enter] – the port displays as '***'.

Screen Prompt	Action
Specify TCP/UDP destination port [MAX] (1-65535) <Enter: ***>	This prompt will not display if you do not select a MIN TCP/UDP destination port. Set the maximum TCP/UDP destination port in your range, from 1 to 65535. If you desire no maximum TCP/UDP destination port, press [Enter] – the port displays as '***'.
Set WRED (Weighted Random Early Discard) <Y or N> <Enter : Y>	Type 'Y' to enable, or 'N' to disable, Weighted Random Early Detect.
Specify Filtering for the rule <Y or N> <Enter : N>	Type 'Y' to filter traffic (i.e., prevent traffic defined in rule from being forwarded). Otherwise, type 'N' or press [Enter] to forward all traffic (no filtering) – this is the default setting.

### 9.3.4.1.2 QoS Rules Configuration (Min/Max Mode)

Open the nested QoS Rules Configuration page from the QoS Configuration page.

```

QoS Rules Configuration
-----
SrcIP      DestIP      Prot  SPort  DPort  MaxBW  MinBW  WF
RL01.. [10.6.20.32/30]  ***/*      RTP  1155   1155   512    0     YN 1.1
RL02.. [ ***/*          ]  12.6.50.2/32  pFTP ***   ***   256    0     YN 1.2
RL03.. [10.6.20.0/24]   ***/*      HTTP ***   ***   384    0     YN 1.3
RL04.. [10.6.20.0/24]   12.6.50.0/24 SMTP ***   ***   32     0     YN 1.4
RL05.. [10.6.20.5/32]   12.6.50.0/24 UDP   ***   161    32    0     YN 1.5
RL06.. [ ***/*          ]  239.240.65.8/32 UDP   ***   ***   512    0     YN 1.6
RL07.. [10.6.20.128/29] ***/*      IP    ***   ***   99999  0     YN 1.7
RL08.. [UNKNOWN]      .....
Def... [ ***/*          ]  ***/*      ALL   ***   ***   99999  0     NN 1.8
-----
[ P-Priority      W-WRED<Yes/No>      F-Filter<Yes/No>      ]
Del.....D
Base.. [1].....B
QoS... [          QoS Enabled          ]

```

Figure 9-18. QoS Rules Configuration (Min/Max Mode)

When in **Minimum/Maximum Mode**, the QoS Rules Configuration page contains the same options and fields as for Max/Pri Mode (see Sect. 9.3.4.1) with the following exceptions:

- You **cannot** assign a Priority.
- You may assign a Minimum Bandwidth, or you may otherwise press [Enter] to assign no Min Bandwidth (displays as '0').

### 9.3.4.2 QoS Configuration > DiffServ Rules Configuration

Open the nested DiffServ Rules Configuration page from the QoS Configuration page.

DiffServ Rules Configuration						
Class	DSCP	MinBw	MaxBW	Priority		
Rule01..[EXFD	101 110	0	99999	3	1	.....1
Rule02..[CLS1	001 000	0	99999	7	1	.....2
Rule03..[CLS2	010 000	0	99999	6	1	.....3
Rule04..[CLS3	011 000	0	99999	5	1	.....4
Rule05..[CLS4	100 000	0	99999	4	1	.....5
Rule06..[CLS5	101 000	0	99999	3	1	.....6
Rule07..[CLS6	110 000	0	99999	2	1	.....7
Rule08..[CLS7	111 000	0	99999	1	1	.....8
Base....[1]						.....B

Figure 9-19. DiffServ Rules Configuration

DiffServ Rules Configuration							
Class	DSCP	Min Bw	Max Bw	Max Percent	Priority		
Rule08.....	[CLS7 111 000	0	99999	0	1	1	.....1
Rule09.....	[ASF1 001 xx0	407	99999	100	7	1	.....2
Rule10.....	[ASF2 010 xx0	165	99999	100	7	1	.....3
Rule11.....	[ASF3 011 xx0	660	99999	100	7	1	.....4
Rule12.....	[ASF4 100 xx0	384	99999	100	7	1	.....5
Rule13.....	[UNKNOWN]						.....6
Rule14.....	[UNKNOWN]						.....7
Rule15.....	[UNKNOWN]						.....8
Base.....	[8]						.....B
Precedence Priority..	[Disabled]						.....C
ASF Max Bandwidth...	[DataRate]						.....M

Figure 9-20. Assured Forwarding Rules

In **DiffServ Mode**, the Packet Processor prioritizes all traffic by the DSCP value contained within the IP header of each packet. All packets that do not have a DSCP value are placed in the Default Queue and have a Priority of 9 (Figure 9-19).

Configuration of DiffServ Rules is allowed only for Assured Forwarding Classes 1-4 (Rule 9-12), where a Minimum and Maximum Bandwidth can be assigned. Use Base 8 to modify the Assured Forwarding Rules (AFD)(Figure 9-20).

### 9.3.5 Route Table Configuration

Open the Route Table Configuration page from the Main Menu.

Configuring the Route Table					
Route Name	Dest IP/SNet Bits	Next Hop	MultiCast State		
Route001... [TestLab	172.18.0.0/16	10.6.30.50	N/A	toEth]	..1
Route002... [Multicast1	239.240.50.15/32	0x5A	LAN->SAT	toSat]	..2
Route003... [FTPServ	192.168.14.22/32	0x10	N/A	toSat]	..3
Route004... [UNKNOWN]					..4
Route005... [UNKNOWN]					..5
Route006... [UNKNOWN]					..6
Route007... [UNKNOWN]					..7
Route008... [UNKNOWN]					..8
Base..... [1]					..B
Delete.....					..D
Display.....					..P
PerRoute.....					..E
DL Mcast... [Disabled]					
AddFilter.....					..A
DelFilter.....					..R

Figure 9-21. Route Table Configuration

Selection	Hot Key	Description
Route001 through Route256 (The current group of eight of up to 256 definable routes are displayed here)	1 – 8	<p>Defines how to route received Packet Processor packets. Assigning an entry in this table is similar to using the 'route add' command of machines that support that command.</p> <p>For each route, the CLI prompts you to define the following:</p> <ul style="list-style-type: none"> <li>Assign a name to reference the route. The assigned name cannot contain any whitespace and must be unique.</li> <li>The destination address of an Packet of interest. The number of network addresses that are governed by the selected destination entry, i.e., subnet mask.</li> <li><b>The Next Hop IP address:</b> This is the IP where the packet is routed for further processing. The Next Hop IP Address for traffic to be sent over the satellite will be the desired HDLC: <ul style="list-style-type: none"> <li>Point-to-Point – no HDLC address</li> <li>Small Network – 0x1 – 0xFE</li> <li>Large Network – 0x1 – 0xFFFE</li> </ul> </li> </ul> <p>Also, a route can be defined to have Packet Processor send traffic to another IP address on the same subnet as the Ethernet interface.</p> <ul style="list-style-type: none"> <li><b>Optionally:</b> If a Multicast address (224.0.0.0-239.255.255.255) is provided as the destination IP address, then the following parameters will be requested:</li> </ul>

Selection	Hot Key	Description
		<ul style="list-style-type: none"> <li>○ <b>Route Multicast packets from Ethernet to Satellite? [y/n]</b> Specifies if Multicast packets that match the provided IP address are routed from the Ethernet to Satellite. "No" means that the packets are discarded.</li> <li>○ <b>Route Multicast packets from Satellite to Ethernet? [y/n]</b>  Specifies if Multicast packets that match the provided IP address are routed from the Satellite to Ethernet. "No" means that the packets are discarded.</li> </ul> <p>Multicast Routes always have a subnet length of 32 and the next hop is 0.0.0.0 because it is not applicable.</p> <p><b>Note:</b> The Packet Processor does allow the specification of one and only one default route. Destination IP = 0.0.0.0 Subnet Length = 0. The default route can be defined to send traffic to either the Satellite or Ethernet interface. This will cause all packets that do not match any other route to be sent to the destination that has been defined for further processing.</p>
Base [#]	<b>B</b>	<p>Set a value, from 1 to 249, to display or edit the group of eight of up to 256 definable QoS Routes.</p> <p><b>For example,</b> if you want to edit Routes 32-40: Type 'B', and then type '32' to select the Base value of 32. The QoS Configuration page will refresh to display Route032 through Route040.</p>
Delete Route	<b>D</b>	Set the number of the Route Name (1 through 8) you want to delete.
Display	<b>P</b>	Displays all of the routes that are currently defined in the system. This includes automatically generated routes that are provided to simplify provisioning of the system. The information displayed is: Route Name, DestIP/Snet Bits, Next Hop, HDLC, and Flags.
PerRoute	<b>E</b>	Use to enable Header Compression, Payload Compression on a Per Route basis.
Downlink Mcast	<b>[RO]</b>	Displays the status of Downlink Multicast as <b>[Enabled]</b> or <b>[Disabled]</b> . This feature is configured on the Administrator Feature page.



### 9.3.5.1 Route Table > Per Route Configuration

Open the nested “Configuring Per Route Capabilities” page from the Route Table Configuration page.

Configuring Per Route Capabilities				
Route Name	HdrComp	PayloadComp	3xDES	3xDESKey
Route001..... [TestLab	Y	Y	N	Clear ]..... 1
Route002..... [Multicast1	N	Y	N	Random]..... 2
Route003..... [FTPServ	Y	Y	N	Key4 ]..... 3
Route004..... [UNKNOWN]				..... 4
Route005..... [UNKNOWN]				..... 5
Route006..... [UNKNOWN]				..... 6
Route007..... [UNKNOWN]				..... 7
Route008..... [UNKNOWN]				..... 8
Base..... [1]				..... B
Transmit Encrypt.. [Per Route]				

Figure 9-22. Route Table Configuration | Per Route

Select the Route Number to configure Header Compression (HdrComp) and Payload Compression (PayloadComp) on a per Route basis.

Selection	Hot Key	Description
Route001 through Route256 (The current group of eight of up to 256 definable are displayed here)	1 – 8	<p>For each route, the CLI prompts you to select the operational states in this order:</p>  <p><b>3xDES Encryption is a future offering and is not available in this firmware release. The 3xDES selections are non-functional at this time. Press Enter to skip these selections.</b></p> <p>"Specify Header compression for this route (Y or N)&lt;Enter : N&gt;"</p> <p>Type 'Y' or 'N' to toggle, or press [Enter] to disable header compression for this route.</p> <p>"Specify Payload compression for this route (Y or N)&lt;Enter : N&gt;"</p> <p>Type 'Y' or 'N' to toggle, or press [Enter] to disable payload compression for this route.</p>
Base [#]	B	<p>Set a value, from 1 to 249, to display or edit a group of eight of up to 256 definable Routes.</p> <p><b>For example</b>, if you want to edit Routes 32-40: Type 'B', and then type '32' to select the Base value of 32. The table will refresh and display Route032 through Route040.</p>
Transmit Encrypt	[RO]	<p>Displays the current operational state for TX Encrypt as "Per Route" or "Disabled".</p>

### 9.3.6 Protocol Configuration

Open the Protocol Configuration Page from the Main Menu.

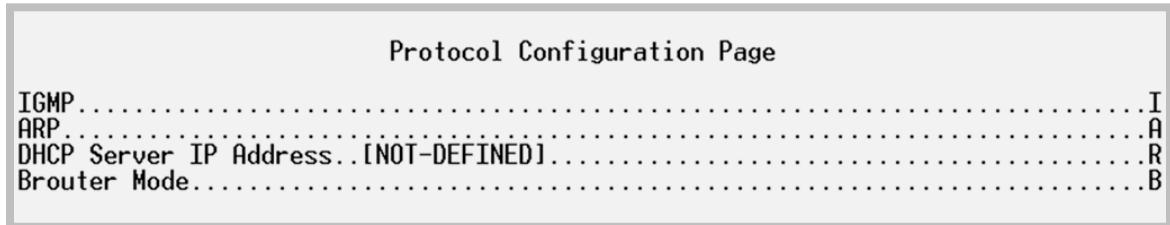

**Figure 9-23. Protocol Configuration**

Selection	Hot Key	Description
IGMP	I	Displays the IGMP page. See Section 9.3.6.1.
ARP	A	Displays the ARP Table Utilities page. See Section 9.3.6.2.
DHCP Server IP Address	R	Allows entry of the DHCP server IP address. Allows hosts on a remote LAN to send DHCP request packets to the DHCP server so that the DHCP server can dynamically assign IP addresses to remote hosts.
Brouter Mode	B	Displays the Brouter Configuration page. See Section 9.3.6.3.

#### 9.3.6.1 Protocol Configuration > IGMP Information

Open the nested IGMP Information page from the Protocol Configuration page.

Use this page to view the IGMP clients that are actively listening to content being provided by the Packet Processor. It also allows you to determine how the Ethernet Interface is configured either to receive requests to join IGMP groups or announce groups for others to join.

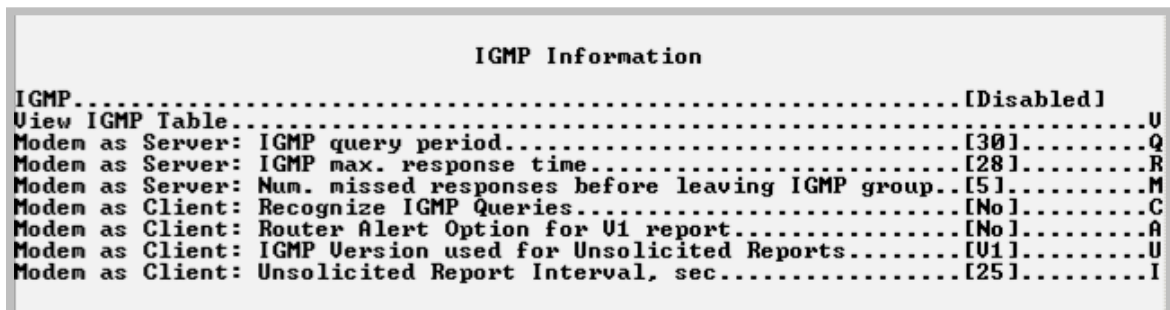

**Figure 9-24. IGMP Information**

Selection	Hot Key	Description
IGMP	[RO]	Displays IGMP status as [Enabled] or [Disabled].
View IGMP Table	V	This table reports the content that clients have subscribed to the Packet Processor using the IGMP protocol. This helps determine which services are being used and the minimum time before a service is terminated.
Modem as Server: IGMP query period	Q	Set a value, in seconds, from 1 to 600. This defines the time interval in which the IGMP protocol requests that a server periodically publish to users on the LAN the Multicast IP Addresses that it can service. The IGMP query period defines the time interval between each of these queries for membership.
Modem as Server: IGMP max. response time	R	Set a value, in seconds, from 1 to 598. This defines the time interval for the IGMP max response time that the Packet Processor should wait before it assumes that no parties are interested in the content published via an IGMP query. The max response time that is accepted by the Packet Processor should a value that is less than the Query period minus 1.
Modem as Server: Number of missed responses before leaving IGMP group	M	Set a value, from 1 to 30. This defines the number of membership queries that go unanswered from LAN clients before the Ethernet Interface no longer forwards data for that IGMP group.  <b>For example</b> , for an Packet Processor that has the IGMP query period set to 60 seconds and the number of missed responses is set to 3: If a client joins an IGMP group, then the service to that group will not be discontinued until no clients respond to a query from the Packet Processor for a period of $60 \times 3 = 180$ seconds.
Modem as Client: Recognize IGMP queries	C	Toggle to set as 'Y' (Yes) or 'N' (No):  <ul style="list-style-type: none"> <li>If you toggle YES, the Packet Processor responds to an IGMP query by requesting to join a Multicast Group published by the server that is defined in the Packet Processor's route table.</li> <li>If you toggle NO, the Packet Processor does not respond to IGMP queries from a server. In this type of configuration, you may configure the Packet Processor to unconditionally request to join an IGMP group at an interval specified by the "Unsolicited Report Interval" option from the Transmitter IGMP Client Configuration Page.</li> </ul>
Modem as Client: Router Alert Option for V1 report	A	Toggle to set as 'Y' (Yes) or 'N' (No):  Some Routers may require the definition of a Router Alert Option to recognize a report from a Client to join a Multicast group. The IP Router Alert Option is defined in RFC2113 and was introduced by Cisco. While this option is not part of the IGMP standard, most IGMP V2 implementations contain this option. However, most implementations of IGMP V1 do not contain this option. This parameter is defined to prevent possible conflicts in networks in which a Cisco Router is configured as an IGMP V1 server.  <ul style="list-style-type: none"> <li>When you toggle YES, the Packet Processor generates IGMP reports to join Multicast groups as specifically required by some Cisco Router configurations.</li> <li>When you toggle NO, the Packet Processor generates IGMP reports to join Multicast groups as defined and implemented by most IGMP servers.</li> </ul>

Selection	Hot Key	Description
Modem as Client: IGMP Version used for Unsolicited Reports	U	<p>Toggle to set as 'V1' or 'V2'. This defines which version of the IGMP protocol should be followed when attempting to join a group on a Multicast Server via an unsolicited report.</p> <p>When the Packet Processor is configured to Recognize IGMP Queries, the Packet Processor will respond to a query in the same version that the server used to initiate the query.</p> <ul style="list-style-type: none"> <li>• When you toggle V1, the CLI configures the Packet Processor to use the IGMP Version 1 protocol to join a Multicast Group available on an IGMP Server in response to an IGMP Query.</li> <li>• When you toggle V2, the CLI configures the Packet Processor to use the IGMP Version 2 protocol to join a Multicast Group available on an IGMP Server in response to an IGMP Query.</li> </ul>
Modem as Client: Unsolicited Report Interval, sec	I	<p>Set a value, in seconds, to configure the time interval for the Packet Processor to generate unsolicited reports to join a Multicast Group. A value of zero implies that no unsolicited reports to join a Multicast group should be generated by the Packet Processor.</p> <p>Each unsolicited report to join a Multicast group will use the version of the IGMP protocol as specified by the IGMP Version used for Unsolicited Reports option.</p>

### 9.3.6.2 Protocol Configuration > ARP Table Utilities

Open the nested ARP Table Utilities page from the Protocol Configuration Page. Use this page to view and edit the ARP table defined by the Packet Processor. It allows up to 256 static IP> MAC ARP entries.

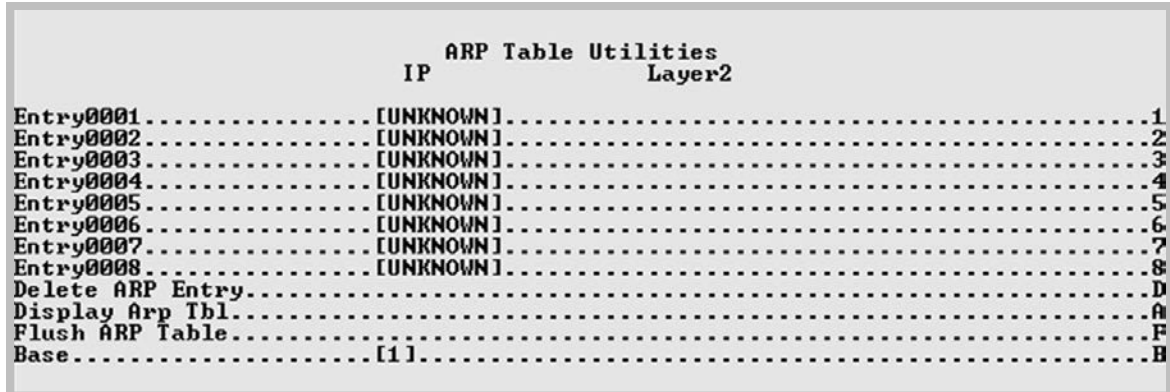

Figure 9-25. ARP Table Utilities

Selection	Hot Key	Description
Entry0001 through Entry0256 (The current group of eight of up to 256 definable static ARP entries are displayed here)	1 – 8	<p>Defines up to 256 static ARP definitions on the Packet Processor. Use this table to operate/view up to eight of these definitions at a time. An ARP definition is defined as:</p> <ul style="list-style-type: none"> <li> <b>Unicast IP Address.</b>                      This IP Address is used as a lookup into the ARP table when the Packet Processor needs to resolve a MAC or HDLC Address.                 </li> </ul> <p><b>Restrictions:</b></p> <ul style="list-style-type: none"> <li>IP Address must be on the same subnet as the Ethernet Interface.</li> <li>IP Address must be a valid Unicast address (Not Multicast, broadcast, etc.)</li> </ul> <ul style="list-style-type: none"> <li> <b>MAC Address</b>                      The MAC Address defines the hardware destination MAC Address that is used when an Ethernet packet is destined for an IP machine from the Packet Processor.                 </li> </ul> <p>At the prompt, type 'M' to add an IP to MAC ARP entry.</p>
Delete ARP Entry	D	Prompts you to Set the IP address of the ARP entry you want to delete.
Display ARP Tbl	A	Displays the entire IP to MAC ARP table in blocks of 10 entries. Includes the Static as well as dynamic ARP entries. Press the Enter key to display the next 10 entries; otherwise, press the Esc (Escape) key to return to ARP Table Utilities page.
Flush ARP Table	F	Allows the entire ARP table to be cleared. This is equivalent to performing the standard UNIX command "arp -d" on each address reported in an "arp -a" command. The command only flushes the dynamic ARP entries. The static ARP entries will not be removed.

Selection	Hot Key	Description
Base [#]	B	Set a value, from 1 to 249, to display or edit a group of eight of up to 256 definable static ARP entries.  For example, if you want to view or edit static ARP Entries 32-40: Type 'B', and then type '32' to select a Base value of 32. The table will refresh and display Entry0032 through Entry0040.

### 9.3.6.3 Protocol Configuration > Brouter Configuration

Open the nested Brouter Configuration page from the Protocol Configuration Page.

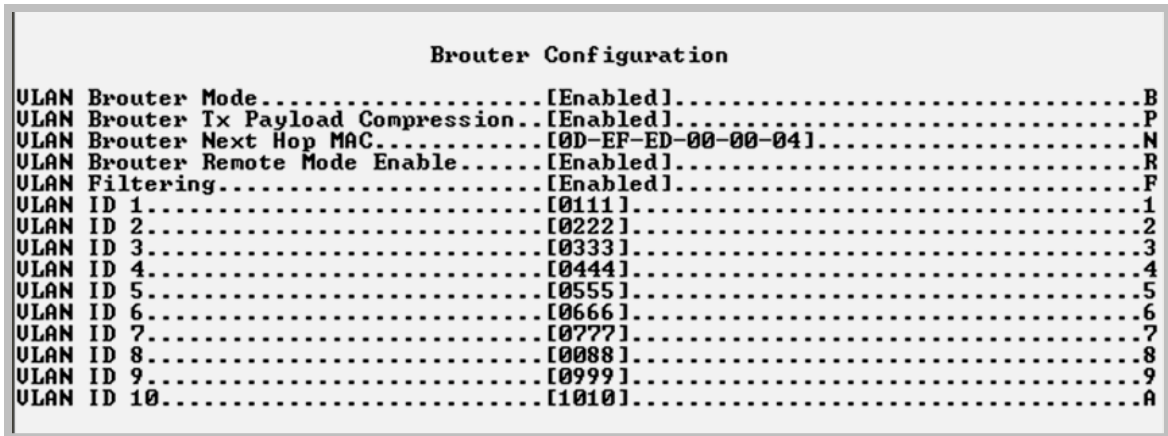



```

Brouter Configuration
VLAN Brouter Mode.....[Enabled].....B
VLAN Brouter Tx Payload Compression...[Enabled].....P
VLAN Brouter Next Hop MAC.....[0D-EF-ED-00-00-04].....N
VLAN Brouter Remote Mode Enable.....[Enabled].....R
VLAN Filtering.....[Enabled].....F
VLAN ID 1.....[0111].....1
VLAN ID 2.....[0222].....2
VLAN ID 3.....[0333].....3
VLAN ID 4.....[0444].....4
VLAN ID 5.....[0555].....5
VLAN ID 6.....[0666].....6
VLAN ID 7.....[0777].....7
VLAN ID 8.....[0888].....8
VLAN ID 9.....[0999].....9
VLAN ID 10.....[1010].....A
  
```

Figure 9-26. Brouter Configuration

Selection	Hot Key	Description
VLAN Brouter Mode	B	Toggle as [Enabled] or [Disabled]:  When you toggle <b>Enabled</b> , any packet arriving at the Ethernet interface with a VLAN header is automatically forwarded to the WAN interface. In this mode ALL VLAN packets are sent – there is no filtering of any kind.   <b>Brouter Mode may be <u>disabled</u> only when both Brouter Remote Mode and VLAN Filtering are also <u>disabled</u>. If selection is attempted while either or both of these features are <u>enabled</u>, the following message displays:</b>  <b>"Disable VLAN-Filter &amp; Remote Mode, And Then Disabled Brouter Mode"</b>
VLAN Brouter Tx Payload Compression	P	Toggle Payload Compression for all "Brouted" VLAN packets as [Enabled] or [Disabled].
VLAN Brouter Next Hop MAC	N	On the downlink side, this allows the definition of the MAC of the next hop router to which all of the Brouted packets must be sent. This permits the Brouter feature to bypass the need to send an ARP packet for packets that could potentially have the same IP address.

Selection	Hot Key	Description
VLAN Brouter Remote Mode Enable	R	<p>Toggle as [Enabled] or [Disabled].</p> <p>In this mode, IP traffic received from the WAN interface will not be forwarded back to the WAN interface, even though the route table matches.</p> <p> Each remote modem must have Remote Mode <u>enabled</u>, indicating this is a distant-end modem.</p>
VLAN Filtering	F	<p>Toggle bridging for all "Bridged" VLAN destination packets and routing of non-VLAN traffic as [Enabled] or [Disabled].</p>
VLAN ID 1 through 10	0001 thru 4094	<p>Assign a numeric VLAN ID in the range from 0001 to 4094.</p> <p> The VLAN ID is a 12-bit field in the Ethernet packet that contains the IEEE-802.1Q tag.</p> <ul style="list-style-type: none"> <li>• VLAN ID 0001 is reserved and used for normal switch operation.</li> <li>• A maximum of 10 VLAN ID matches are supported. Unused VLAN ID match fields must be set to values that DO NOT match any network VLAN IDs.</li> </ul>

### 9.3.7 Vipersat Configuration



VMS v3.x.x VIPERSAT Management System User Guide (CEFD P/N MN/22156)



This page displays only if the optional Vipersat feature is enabled.

Open the Vipersat Configuration page from the Main Menu.

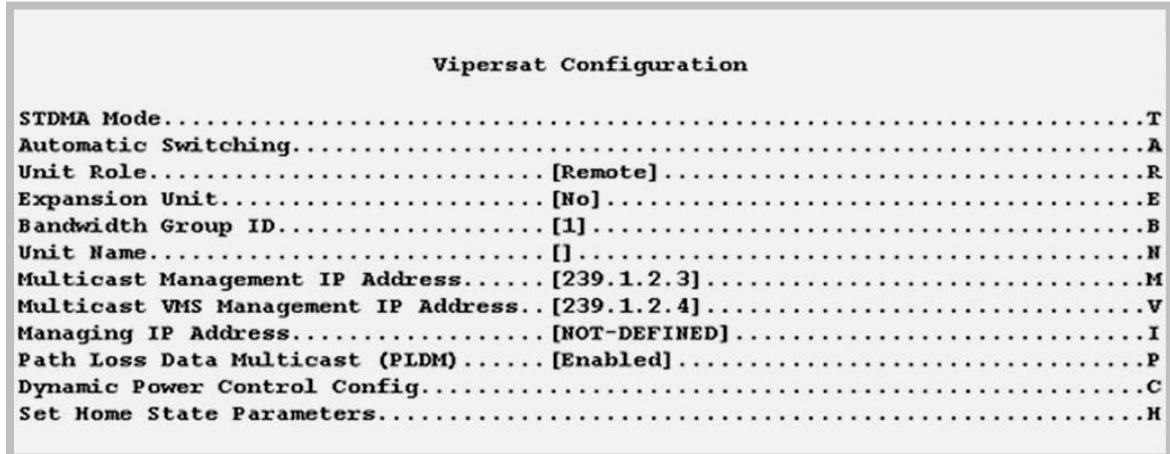

Figure 9-27. Vipersat Configuration

Selection	Hot Key	Description
STDMA Mode	T	Used only when CDM-570A/570AL is used in a Vipersat Management System (VMS). See the VMS v3.x.x VIPERSAT Management System User Guide (CEFD P/N MN/22156) for complete information.
Automatic Switching	A	
Unit Role	R	
Expansion Unit	E	
Bandwidth Group ID	B	
Unit Name	N	
Multicast Management IP Address	M	
Multicast VMS Management IP Address	V	
Managing IP Address	I	
Path Loss Data Multicast (PLDM)	P	
Dynamic Power Control Config	C	
Set Home State Parameters	H	



### 9.3.8 Satellite Modem

Open the Satellite Modem page from the Main Menu.

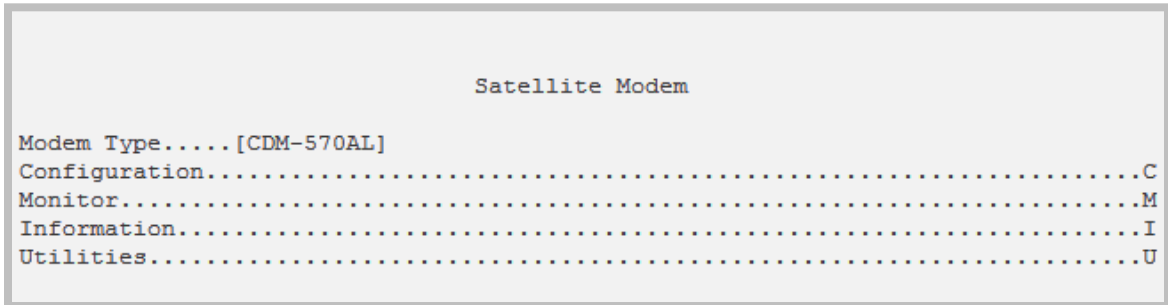
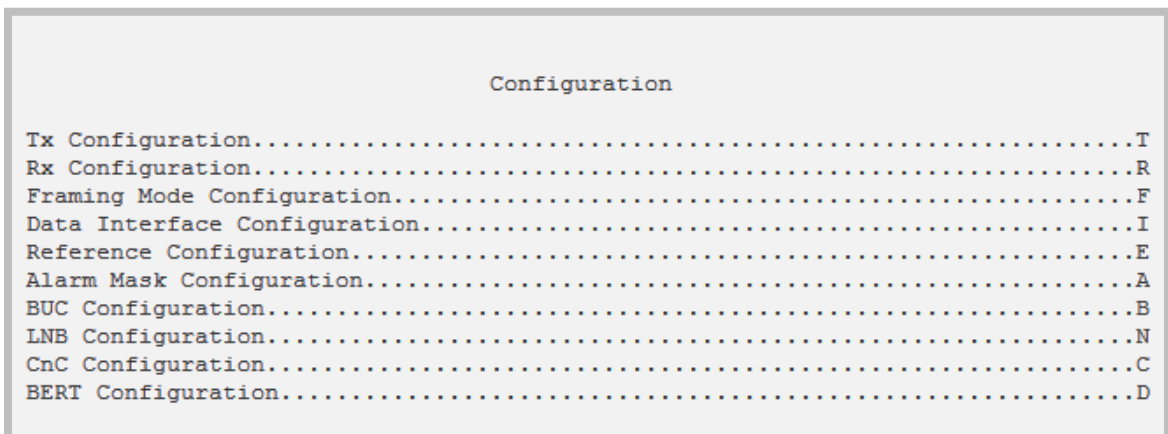

**Figure 9-28. Modem Parameters**

Selection	Hot Key	Description
Modem Type	[RO]	Identifies the Modem Type – CDM-570A or CDM-570AL.
Configuration	C	Displays the Modem Configuration page. See Section 9.3.8.1.
Monitor	M	Displays the Modem Monitor page. See Section 9.3.8.2.
Information	I	Displays the Modem Information page. See Section 9.3.8.3.
Utilities	U	Displays the Modem Utilities page. See Section 9.3.8.4.

#### 9.3.8.1 Satellite Modem > Configuration

Open the nested Configuration page from the Satellite Modem page.



**Figure 9-29. Modem Configuration**

Selection	Hot Key	Description
Tx Configuration	T	Displays the Tx Configuration page. See Section 9.3.8.1.1.
Rx Configuration	R	Displays the Rx Configuration page. See Section 9.3.8.1.2.
Framing Mode Configuration	F	Displays the Framing Mode Configuration page. See Section 9.3.8.1.3.
Data Interface Configuration	I	Displays the Data Interface Configuration page. See Section 9.3.8.1.4.
Reference Configuration	E	Displays the Reference Configuration page. See Section 9.3.8.1.5.
Alarm Mask Configuration	A	Displays the Alarm Mask Configuration page. See Section 9.3.8.1.6.
BUC Configuration	B	Displays the BUC (Block Up Converter) Configuration page. See Section 9.3.8.1.7.
LNB Configuration	N	Displays the LNB (Low Noise Block Down Converter) Configuration page. See Section 9.3.8.1.8.
CnC Configuration	C	Displays the CnC (DoubleTalk Carrier-in-Carrier) Configuration page. See Section 9.3.8.1.9.
BERT Configuration	D	Displays the BERT (Bit Error Rate Test) Configuration page. See Section 9.3.8.1.10.

### 9.3.8.1.1 Satellite Modem > Configuration > Tx Configuration

Open the nested Tx (Modulation) Configuration page from the Configuration page.

```

Tx Configuration
Tx Frequency.....[1000.0000].....Q
Tx Data Rate.....[02116.747].....D
Tx Symbol Rate.....[0620.201]
Tx FEC.....[UrsaFEC].....T
Tx Code Rate.....[UrsaFEC CCM 16-QAM 0.853].....R
Tx Modulation.....[16-QAM].....M
Tx Spectrum Inversion..[Normal].....U
Tx Data Inversion.....[Normal].....I
Tx Scrambling.....[On-Default].....B
Tx Power Level.....[40.0].....P
Tx Carrier.....[On].....C
Tx Clock Source.....[Internal]
Tx Clock Inversion.....[Normal].....A
Tx Filter Rolloff.....[0.35].....E

Save Parameters to permanent storage.....S
Exit.....X
Telnet Logout.....L

```

Figure 9-30. Tx (Transmit Modem) Configuration



**Turbo FEC selections are displayed only if the optional Turbo card is installed.**

Selection	Hot Key	Description
Tx Frequency	Q	Set the Tx frequency – valid ranges are: <ul style="list-style-type: none"> <li>From 50 to 180 MHz for the CDM-570A (IF);</li> <li>From 950 to 1950 MHz for the CDM-570AL (L-Band).</li> </ul>
Tx Data Rate	D	Set the rate at which the Modem will send traffic over the Satellite Interface: <ul style="list-style-type: none"> <li>Valid range is from 2.4 to 9980 kbps.</li> <li>Up to 5000 kbps and 9980 kbps are options that must be purchased.</li> </ul>
Tx Symbol Rate	[RO]	Displays the corresponding Symbol Rate for the currently selected data rate, encoder, rate, and modulation scheme.
Tx FEC	T	Select the Tx FEC type: <ul style="list-style-type: none"> <li>1 -- Uncoded</li> <li>2 -- Viterbi</li> <li>3 -- Vit+RS</li> <li>4 -- TCM+RS</li> <li>5 -- Turbo</li> <li>6 – VersaFEC</li> <li>7 -- ULL</li> <li>8 -- VersaFEC-2 Long</li> <li>9 -- VersaFEC-2 Short</li> </ul>
Tx Code Rate	R	Select the Tx code rate: <ul style="list-style-type: none"> <li>1 – 5/16</li> <li>2 – 21/44</li> <li>3 – 1/2</li> <li>4 – 2/3</li> <li>5 – 3/4</li> <li>6 – 7/8</li> <li>7 – 0.95</li> <li>8 – 1/1</li> <li>9 – VersaFEC CCM BPSK 0.488</li> <li>10 – VersaFEC CCM QPSK 0.533</li> <li>11 – VersaFEC CCM QPSK 0.631</li> <li>12 – VersaFEC CCM QPSK 0.706</li> <li>13 – VersaFEC CCM QPSK 0.803</li> <li>14 – VersaFEC CCM 8-QAM 0.576</li> <li>15 – VersaFEC CCM 8-QAM 0.642</li> <li>16 – VersaFEC CCM 8-QAM 0.711</li> <li>17 – VersaFEC CCM 8-QAM 0.780</li> <li>18 – VersaFEC CCM 16-QAM 0.644</li> <li>19 – VersaFEC CCM 16-QAM 0.731</li> <li>20 – VersaFEC CCM 16-QAM 0.780</li> <li>21 – VersaFEC CCM 16-QAM 0.829</li> <li>22 – VersaFEC CCM 16-QAM 0.853</li> <li>23 – VersaFEC ULL BPSK 0.493</li> <li>24 – VersaFEC ULL QPSK 0.493</li> </ul>

Selection	Hot Key	Description
TX Code Rate (continued)		25 – VersaFEC ULL QPSK 0.654 26 – VersaFEC ULL QPSK 0.734 27 – VersaFEC-2 ModCod_0 – BPSK 0.489 28 – VersaFEC-2 ModCod_1 – QPSK 0.489 29 – VersaFEC-2 ModCod_2 – QPSK 0.537 30 – VersaFEC-2 ModCod_3 – QPSK 0.586 31 – VersaFEC-2 ModCod_4 – QPSK 0.611 32 – VersaFEC-2 ModCod_5 – QPSK 0.635 33 – VersaFEC-2 ModCod_6 – QPSK 0.660 34 – VersaFEC-2 ModCod_7 – QPSK 0.684 35 – VersaFEC-2 ModCod_8 – QPSK 0.733 36 – VersaFEC-2 ModCod_9 – 8_ARY 0.521 37 – VersaFEC-2 ModCod_10 – 8_ARY 0.537 38 – VersaFEC-2 ModCod_11 – 8_ARY 0.562 39 – VersaFEC-2 ModCod_12 – 8_ARY 0.586 40 – VersaFEC-2 ModCod_13 – 8_ARY 0.611 41 – VersaFEC-2 ModCod_14 – 8_ARY 0.635 42 – VersaFEC-2 ModCod_15 – 8_ARY 0.660 43 – VersaFEC-2 ModCod_16 – 8_ARY 0.684 44 – VersaFEC-2 ModCod_17 – 8_ARY 0.708 45 – VersaFEC-2 ModCod_18 – 8_ARY 0.733 46 – VersaFEC-2 ModCod_19 – 16_ARY 0.586 47 – VersaFEC-2 ModCod_20 – 16_ARY 0.611 48 – VersaFEC-2 ModCod_21 – 16_ARY 0.635 49 – VersaFEC-2 ModCod_22 – 16_ARY 0.660 50 – VersaFEC-2 ModCod_23 – 16_ARY 0.684 51 – VersaFEC-2 ModCod_24 – 16_ARY 0.708 52 – VersaFEC-2 ModCod_25 – 16_ARY 0.733 53 – VersaFEC-2 ModCod_26 – 16_ARY 0.757 54 – VersaFEC-2 ModCod_27 – 16_ARY 0.782 55 – VersaFEC-2 ModCod_28 – 32_ARY 0.660 56 – VersaFEC-2 ModCod_29 – 32_ARY 0.684 57 – VersaFEC-2 ModCod_30 – 32_ARY 0.708 58 – VersaFEC-2 ModCod_31 – 32_ARY 0.733 59 – VersaFEC-2 ModCod_32 – 32_ARY 0.757 60 – VersaFEC-2 ModCod_33 – 32_ARY 0.782 61 – VersaFEC-2 ModCod_34 – 32_ARY 0.801 62 – VersaFEC-2 ModCod_35 – 32_ARY 0.831 63 – VersaFEC-2 ModCod_36 – 32_ARY 0.855 64 – VersaFEC-2 ModCod_37 – 32_ARY 0.879

Selection	Hot Key	Description
Tx Modulation	<b>M</b>	Select the Tx modulation type: 1 -- BPSK 2 -- QPSK 3 -- OQPSK 4 -- 8-PSK 5 -- 16-QAM 6 -- 8-QAM 7 -- 8-ARY (VersaFEC-2) 8 -- 16-ARY (VersaFEC-2) 9 -- 32-ARY (VersaFEC-2)
Tx Spectrum Inversion	<b>U</b>	Select the Tx spectral inversion type: 1 – Normal 2 – Inverted
Tx Data Inversion	<b>I</b>	Select the Tx data inversion type: 1 – Normal 2 – Inverted
Tx Scrambling	<b>B</b>	Select the Tx scrambling type: 1 – Off 2 – On-Default 3 – On-IESS-315
Tx Output Power	<b>P</b>	Set a valid output power from 0.0 to 40.0 dBm (minus sign assumed).
Tx Carrier	<b>C</b>	Select the Tx carrier operation: 1 – OFF 2 – ON 3 – Rx-Tx Inhibit (turns off the transmitter if the Rx is not locked) <b>NOTE:</b> In a 1:1 Redundant system, the standby modem will display <b>[External Control]</b> .
Tx Clock Source	<b>[RO]</b>	Displays the configured Tx Clock Source.
Tx Clock Inversion	<b>A</b>	Select the Tx clock inversion type: 1 – Normal 2 – Inverted
Tx Filter Rolloff	<b>E</b>	Select the Tx alpha filter rolloff: 1 – 0.35 2 – 0.25 3 – 0.20 4 – 0.15 5 – 0.10 6 – 0.05

### 9.3.8.1.2 Satellite Modem > Configuration > Rx Configuration

Open the nested Rx (Demodulation) Configuration page from the Configuration page.

```

Rx Configuration
Rx Frequency.....[1000.0000].....Q
Rx Data Rate.....[02116.747].....D
Rx Symbol Rate.....[1983.976]
Rx FEC.....[VersaFEC].....T
Rx Code Rate.....[VersaFEC CCM QPSK 0.533].....R
Rx Demodulation.....[QPSK].....M
Rx Spectrum Inversion..[Normal].....U
Rx Data Inversion.....[Normal].....I
Rx Descrambling.....[On-Default].....B
Rx Acquisition Range...[010].....W
Eb/No Alarm Point.....[02.0].....P
Rx Buffer Size.....[Disabled].....F
Recenter Rx Buffer.....C
Rx Clock Inversion.....[Normal].....A
Rx Filter Rolloff.....[0.35].....E

Save Parameters to permanent storage.....S
Exit.....X
Telnet Logout.....L

```

Figure 9-31. Rx (Receive Modem) Configuration



**Turbo FEC selections are displayed only if the optional Turbo card is installed.**

Selection	Hot Key	Description
Rx Frequency	Q	Set the Rx frequency – valid ranges are: <ul style="list-style-type: none"> <li>From 50 to 180 MHz for the CDM-570A (IF);</li> <li>From 950 to 1950 MHz for the CDM-570AL (L-Band).</li> </ul>
Rx Data Rate	D	Set the rate at which the Modem will receive traffic from the Satellite Interface: <ul style="list-style-type: none"> <li>Valid range is from 2.4 to 9980 kbps.</li> <li>Up to 5000 kbps and 9980 kbps are options that must be purchased.</li> </ul>
Rx Symbol Rate	[RO]	Displays the corresponding Symbol Rate for the currently selected data rate, decoder, rate, and demodulation scheme.
Rx FEC	T	Select the Rx FEC type: <ul style="list-style-type: none"> <li>1 -- Uncoded</li> <li>2 -- Viterbi</li> <li>3 -- Vit+RS</li> <li>4 -- TCM+RS</li> <li>5 -- Turbo</li> <li>6 -- VersaFEC</li> <li>7 -- ULL</li> <li>8 -- VersaFEC-2 Long</li> <li>9 -- VersaFEC-2 Short</li> </ul>
Rx Code Rate	R	Select the Rx Code Rate: <ul style="list-style-type: none"> <li>1 – 5/16</li> <li>2 – 21/44</li> <li>3 – 1/2</li> </ul>

Selection	Hot Key	Description
RX Code Rate (continued)		4 – 2/3 5 – 3/4 6 – 7/8 7 – 0.95 8 – 1/1 9 – VersaFEC CCM BPSK 0.488 10 – VersaFEC CCM QPSK 0.533 11 – VersaFEC CCM QPSK 0.631 12 – VersaFEC CCM QPSK 0.706 13 – VersaFEC CCM QPSK 0.803 14 – VersaFEC CCM 8-QAM 0.576 15 – VersaFEC CCM 8-QAM 0.642 16 – VersaFEC CCM 8-QAM 0.711 17 – VersaFEC CCM 8-QAM 0.780 18 – VersaFEC CCM 16-QAM 0.644 19 – VersaFEC CCM 16-QAM 0.731 20 – VersaFEC CCM 16-QAM 0.780 21 – VersaFEC CCM 16-QAM 0.829 22 – VersaFEC CCM 16-QAM 0.853 23 – VersaFEC ULL BPSK 0.493 24 – VersaFEC ULL QPSK 0.493 25 – VersaFEC ULL QPSK 0.654 26 – VersaFEC ULL QPSK 0.734 27 – VersaFEC-2 ModCod_0 – BPSK 0.489 28 – VersaFEC-2 ModCod_1 – QPSK 0.489 29 – VersaFEC-2 ModCod_2 – QPSK 0.537 30 – VersaFEC-2 ModCod_3 – QPSK 0.586 31 – VersaFEC-2 ModCod_4 – QPSK 0.611 32 – VersaFEC-2 ModCod_5 – QPSK 0.635 33 – VersaFEC-2 ModCod_6 – QPSK 0.660 34 – VersaFEC-2 ModCod_7 – QPSK 0.684 35 – VersaFEC-2 ModCod_8 – QPSK 0.733 36 – VersaFEC-2 ModCod_9 – 8_ARY 0.521 37 – VersaFEC-2 ModCod_10 – 8_ARY 0.537 38 – VersaFEC-2 ModCod_11 – 8_ARY 0.562 39 – VersaFEC-2 ModCod_12 – 8_ARY 0.586 40 – VersaFEC-2 ModCod_13 – 8_ARY 0.611 41 – VersaFEC-2 ModCod_14 – 8_ARY 0.635 42 – VersaFEC-2 ModCod_15 – 8_ARY 0.660 43 – VersaFEC-2 ModCod_16 – 8_ARY 0.684 44 – VersaFEC-2 ModCod_17 – 8_ARY 0.708 45 – VersaFEC-2 ModCod_18 – 8_ARY 0.733 46 – VersaFEC-2 ModCod_19 – 16_ARY 0.586 47 – VersaFEC-2 ModCod_20 – 16_ARY 0.611 48 – VersaFEC-2 ModCod_21 – 16_ARY 0.635 49 – VersaFEC-2 ModCod_22 – 16_ARY 0.660 50 – VersaFEC-2 ModCod_23 – 16_ARY 0.684 51 – VersaFEC-2 ModCod_24 – 16_ARY 0.708

Selection	Hot Key	Description
RX Code Rate (continued)		52 – VersaFEC-2 ModCod_25 – 16_ARY 0.733 53 – VersaFEC-2 ModCod_26 – 16_ARY 0.757 54 – VersaFEC-2 ModCod_27 – 16_ARY 0.782 55 – VersaFEC-2 ModCod_28 – 32_ARY 0.660 56 – VersaFEC-2 ModCod_29 – 32_ARY 0.684 57 – VersaFEC-2 ModCod_30 – 32_ARY 0.708 58 – VersaFEC-2 ModCod_31 – 32_ARY 0.733 59 – VersaFEC-2 ModCod_32 – 32_ARY 0.757 60 – VersaFEC-2 ModCod_33 – 32_ARY 0.782 61 – VersaFEC-2 ModCod_34 – 32_ARY 0.801 62 – VersaFEC-2 ModCod_35 – 32_ARY 0.831 63 – VersaFEC-2 ModCod_36 – 32_ARY 0.855 64 – VersaFEC-2 ModCod_37 – 32_ARY 0.879
Rx Demodulation	<b>M</b>	Select the Rx Demodulation type: 1 – BPSK 2 – QPSK 3 – OQPSK 4 – 8-PSK 5 – 16-QAM 6 – 8-QAM 7 – 8-ARY 8 – 16-ARY 9 – 32-ARY
Rx Spectrum Inversion	<b>U</b>	Select the Rx spectral inversion type: 1 – Normal 2 – Inverted
Rx Data Inversion	<b>I</b>	Select the Rx data inversion type: 1 – Normal 2 – Inverted
Rx Descrambling	<b>B</b>	Select the Rx descrambling type: 1 – Off 2 – On-Default 3 – On-IESS-315
Rx Acquisition Range	<b>W</b>	Set an acquisition value in the range from 0 to 200 kHz (1 to 32 kHz if symbol rate < 625 Ksymbol) ("∞" is implied).
Eb/No Alarm Point	<b>F</b>	Set an alarm point value in the range from 0.1 to 16.0 dB. If the $E_b/N_0$ falls below this value, the modem generates a receive traffic fault.
Recenter Rx Buffer	<b>C</b>	Select to force re-centering of the Plesiochronous/Doppler buffer.
Rx Clock Inversion	<b>A</b>	Select the Rx clock inversion type: 1 – Normal 2 – Inverted
Rx Filter Rolloff	<b>E</b>	Select the Rx alpha filter rolloff: 1 – 0.35 2 – 0.25



### 9.3.8.1.3 Satellite Modem > Configuration > Framing Mode Configuration

Open the nested Framing Mode Configuration page from the Configuration page.

```

Framing Mode Configuration
Framing Mode.....[Unframed].....F
EDMAC Mode.....[EDMAC Off].....D
EDMAC Slave Address Range.....[0020].....U
AUPC.....[Disable].....A
Max Power Reached Action.....[No_Action].....R
Remote Demod Unlock Action.....[Nominal_Power].....U
Target Eb/No of Remote Demod (db).....[3.0].....E
Maximum Power Limit.....[3].....M
  
```

**Figure 9-32. Framing Mode Configuration**

Selection	Hot Key	Description
Framing Mode	F	Select the Framing Mode: 1 – Unframed 2 – EDMAC Framing 3 – EDMAC-2 Framing
EDMAC Mode	D	Select the EDMAC Framing Mode: 1 – Unframed 2 – EDMAC Framing 3 – EDMAC-2 Framing
EDMAC Slave Address Range	V	Set a value from 10 to 9990 in multiples of ten.
AUPC	A	Select the AUPC operation: 1 – Enable 2 – Disable
Max Power Reached Action	R	Select the action: 1 – No_Action 2 – Generate_TX_Alarm
Remote Demod Unlock Action	U	Select the action: 1 – Nominal_Power 2 – Maximum_Power
Target $E_b/N_0$ of Remote Demod (db)	E	Set a value from 0.0 to 9.9.
Maximum Power Limit	M	Set a value from 0 to 9.

### 9.3.8.1.4 Satellite Modem > Configuration > Data Interface Configuration

Open the nested Data Interface Configuration page from the Configuration page.

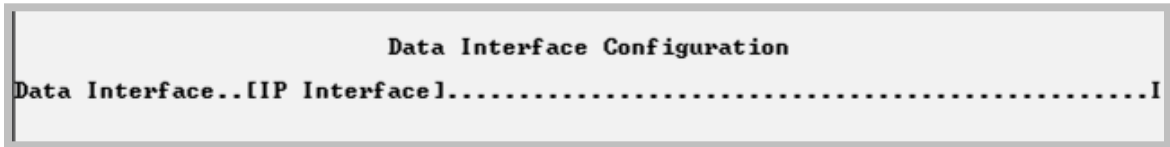

Figure 9-33. Data Interface Configuration

Selection	Hot Key	Description
Data Interface	I	Select the Data Interface: 1 – EAI-422/EAI-530 DCE 2 – V.35 DCE 3 – EAI-232(sync) 4 – G.703 T1 AMI 5 – G.703 T1 B8ZS 6 – G.703 E1 Unbal AMI 7 – G.703 E1 Unbal HDB3 8 – G.703 E1 Bal AMI 9 – G.703 E1 Bal HDB3 10 – IP Interface 11 – IP-ACM  NOTE: You must set the data interface as 10 – IP Interface or 11 – IP-ACM for IP traffic to pass over the satellite.

### 9.3.8.1.5 Satellite Modem > Configuration > Reference Configuration

Open the nested Reference Configuration page from the Configuration page.

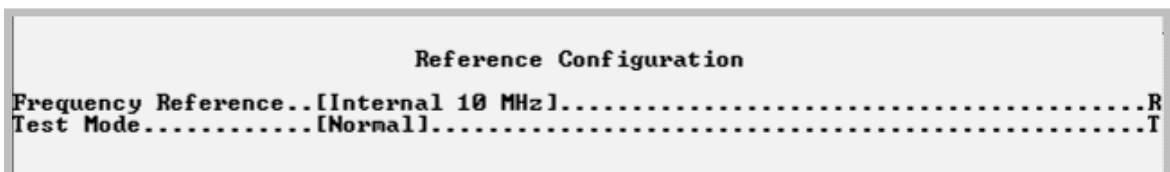

Figure 9-34. Reference Configuration

Selection	Hot Key	Description
Frequency Reference	R	Select the Frequency Reference: 1 – Internal 10 MHz 2 – External 1 MHz 3 – External 2 MHz 4 – External 5 MHz 5 – External 10 MHz 6 – Internal Plus Output
Test Mode	T	Select the Test Mode: 1 – Normal 2 – IF_loopback 3 – Digital_loopback 4 – I/O_Loopback 5 – RF Loopback 6 – Tx_CW 7 – TX_alt_101010

### 9.3.8.1.6 Satellite Modem > Configuration > Alarm Mask Configuration

Open the nested Alarm Mask Configuration page from the Configuration page.

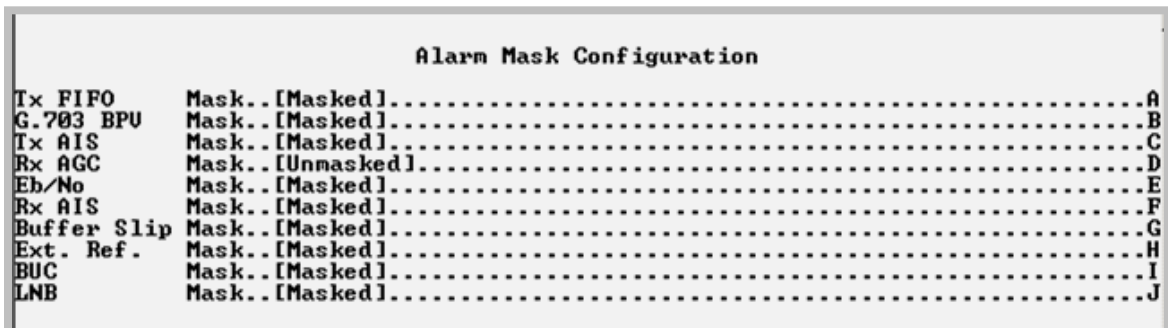
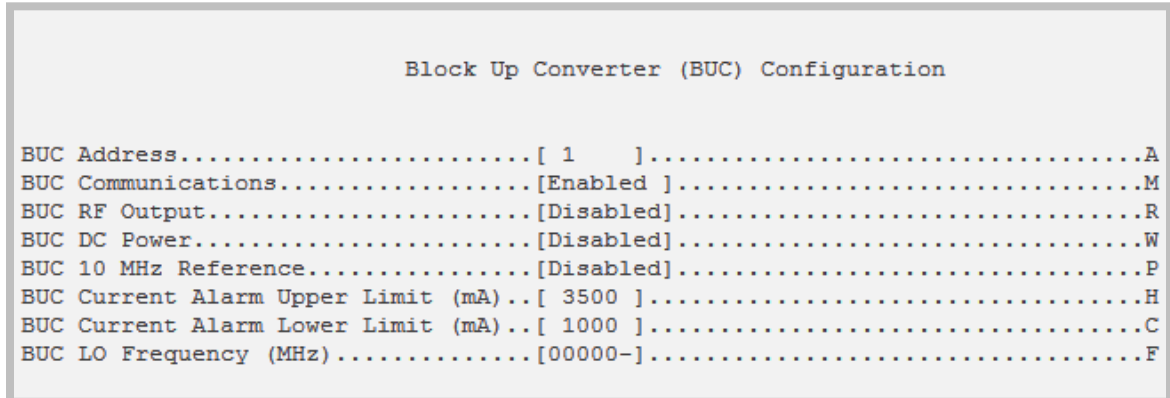

Figure 9-35. Alarm Mask Configuration

Selection	Hot Key	Description
Tx FIFO	A	Toggle to set alarm masking as <b>Masked</b> or <b>Unmasked</b> .
G.703 BPV	B	
Tx AIS	C	<b>NOTE:</b> These settings should always be set as <b>Masked</b> when IP is the active data interface.
Rx AGC	D	
E <sub>b</sub> /N <sub>0</sub>	E	Toggle to set alarm masking as <b>Masked</b> or <b>Unmasked</b> .
Rx AIS	F	
Buffer Slip	G	Toggle to set alarm masking as <b>Masked</b> or <b>Unmasked</b> .  <b>NOTE:</b> This setting should always be set as <b>Masked</b> when IP is the active data interface.
External Reference	H	Toggle to set alarm masking as <b>Masked</b> or <b>Unmasked</b> .
BUC	I	
LNB	J	

### 9.3.8.1.7 Satellite Modem > Configuration > BUC (Block Up Converter) Configuration

Open the nested Block Up Converter (BUC) Configuration page from the Configuration page.



**Figure 9-36. BUC (Block Up Converter) Configuration**

Selection	Hot Key	Description
BUC Address	A	Set an address for the BUC in the range from 1 to 15.
BUC Communications	M	Toggle to set operation as <b>Enabled</b> or <b>Disabled</b> .
BUC RF Output	R	
BUC DC Power	W	
BUC 10 MHz Reference	P	
BUC Current Alarm Upper Limit (mA)	H	Set a value in the range from 500 to 4000.
BUC Current Alarm Lower Limit (mA)	C	Set a value in the range from 0 to 3000.
BUC LO Frequency (MHz)	F	Set a value in the range from 3000 to 65000. Set this value to 0 to disable.

### 9.3.8.1.8 Satellite Modem > Configuration > LNB (Low Noise Block Converter) Configuration

Open the nested Low Noise Block (Down) Converter (LNB) Configuration page from the Configuration page.

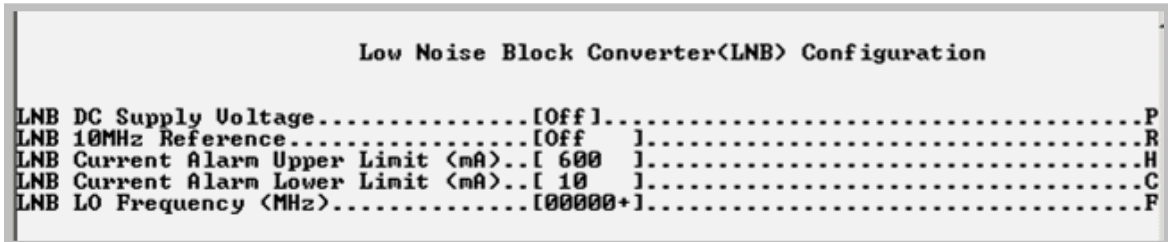
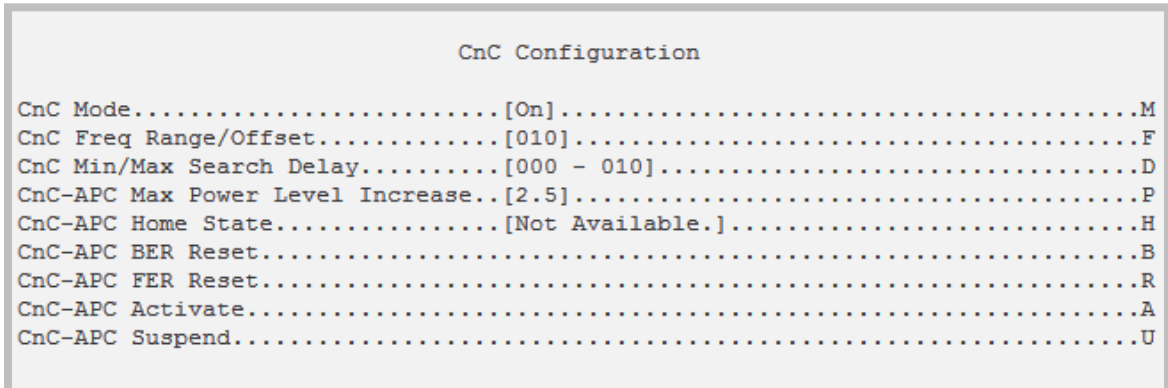

Figure 9-37. LNB (Low Noise Block Converter) Configuration

Selection	Hot Key	Description
LNB DC Supply Voltage	P	Select the voltage value: 1 – Off 2 – 13 Volts 3 – 18 Volts 4 – 24 Volts
LNB 10MHz Reference	R	Toggle operation as <b>On</b> or <b>Off</b> .
LNB Current Alarm Upper Limit (mA)	H	Set a value, in mA, in the range from 50 to 600.
LNB Current Alarm Lower Limit (mA)	C	Set a value, in mA, in the range from 10 to 400.
LNB LO Frequency (MHz)	F	Set a value in the range from 3000 to 65000. Set this value to 0 to disable.

### 9.3.8.1.9 Satellite Modem > Configuration > CnC Configuration

Open the nested CnC Configuration page from the Configuration page.



**Figure 9-38. CnC Configuration**

Selection	Hot Key	Description
CnC Mode	M	Select the CnC operating mode: 1 – Off 2 – On 3 – APC, Side-A, C-Band 4 – APC, Side-A, X-Band 5 – APC, Side-A, Ku-Band 6 – APC, Side-A, Ka-Band 7 – APC, Side-B, C-Band 8 – APC, Side-B, X-Band 9 – APC, Side-B, Ku-Band 10 – APC, Side-A, Ka-Band
CnC Freq Range/Offset	F	This value is set depending on the Rx symbol rate as follows: <ul style="list-style-type: none"> <li>• 16ksps to 64ksps: <math>\pm 1</math> to the symbol rate (ksps)/2</li> <li>• 64ksps and above: <math>\pm 1</math> to 32 kHz</li> </ul>
CnC Min/Max Search Delay	D	At the prompts, set the minimum and maximum search delay values, in milliseconds, in the range from 0 to 300.
CnC-APC Max Power Level Increase	P	Set a value in the range from 0.0 to 9.9.
CnC-APC Home State	H	 See the “AHS” Remote Command/Query in Chapter 8. SERIAL-BASED REMOTE PRODUCT MANAGEMENT for details on using this feature.
CnC-APC BER Reset	B	Toggle to reset.
CnC-APC FER Reset	R	Toggle to reset.
CnC-APC Activate	A	Toggle to activate CnC-APC.
CnC-APC Suspend	U	Toggle to suspend CnC-APC.

### 9.3.8.1.10 Satellite Modem > Configuration > BERT Configuration

Open the nested BERT Configuration page from the Configuration page.

```

                                BERT Configuration

BERT Tx State.... [Off]..... A
BERT Rx State.... [Off]..... B
BERT Tx Pattern.. [1:1]..... C
BERT Rx Pattern.. [1:1]..... D
Error Insert..... I
Restart Monitor..... R

```

**Figure 9-39. BERT (Bit Error Rate Test) Configuration**

Selection	Hot Key	Description
BERT Tx State	A	Select the BERT Tx or Rx operating mode: 1 – Off 2 – On
BERT Rx State	B	
BERT Tx Pattern	C	Select the BERT Tx or Rx pattern: 1 – 1:1 2 – 2047 3 – 2 <sup>15</sup> -1 4 – 2 <sup>23</sup> -1
BERT Rx Pattern	D	
Error Insert	I	Select to insert an error into the ongoing BERT.
Restart Monitor	R	Select to restart the BERT Monitor.

### 9.3.8.2 Satellite Modem > Monitor

Open the nested Monitor page from the Satellite Modem page.

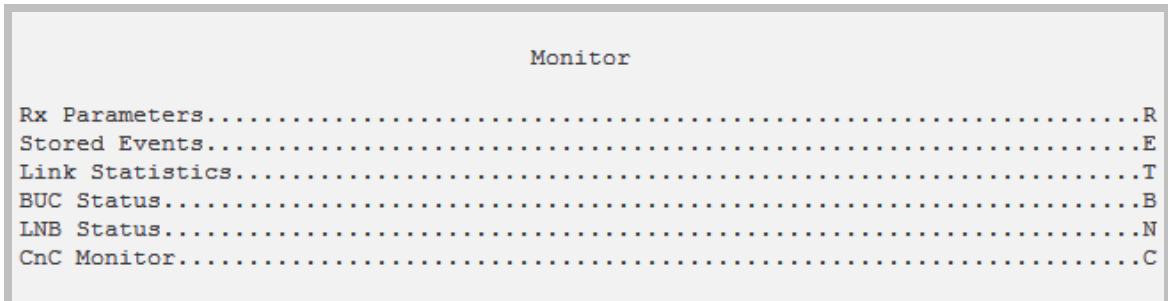

**Figure 9-40. Monitor**

Selection	Hot Key	Description
Rx Parameters	R	Review Rx Parameters: EbNo, Signal Level, Frequency Offset, BER, Bit Errors, and Average BER.
Stored Events	E	Review logged operational events (i.e., alarms). See Section 9.3.8.2.1.
Link Statistics	T	Review current operating link statistics. See Section 9.3.8.2.2.
BUC Status	B	Displays the BUC operational status when a Block Up Converter is connected to a CDM-570AL (L-Band) Satellite Modem. See Section 9.3.8.2.3.
LNB Status	N	Displays the LNB operational status when a Low Noise Block Down Converter is connected to a CDM-570AL (L-Band) Satellite Modem. See Section 9.3.8.2.4.
CnC Monitor	C	Displays the current Carrier-in-Carrier configuration and operational information. See Section 9.3.8.2.5.



### 9.3.8.2.1 Satellite Modem > Monitor > Stored Events

Open the nested Stored Events page from the Monitor page.

```

                                Stored Events

Number Of Unviewed Stored Events.. [007]
Jump To First Stored Event.....J
View Next 5 Stored Events.....V
Clear All Stored Events.....C

Save Parameters to permanent storage.....S
Exit.....X
Telnet Logout.....L
v
28/10/14 14:03:04 Info  Log Cleared
28/10/14 14:03:04 Fault Demodulator unlocked
29/10/14 22:58:48 Info  Power Off
29/10/14 22:58:58 Info  Power On
29/10/14 22:59:33 Info  Global Config Change

                                Press Any Key to Continue

```

**Figure 9-41. Stored Events**

Selection	Hot Key	Description
Number of Unviewed Stored Events	[RO]	Displays the total number of <i>unread</i> stored events. As stored event groups are displayed, the counter decrements accordingly.
Jump To First Stored Event	J	Upon selection, sets the listings for Hot Key 'V' to the first event that was stored subsequent to the latest buffer reset.
View Next 5 Stored Events	V	Buffers the next group of five stored events into the events window. Event information is presented as shown in <b>Figure 9-41</b> .
Clear All Stored Events	C	Erases all entries from the stored events logging buffer.

### 9.3.8.2.2 Satellite Modem > Monitor > Link Statistics

Open the nested Link Statistics page from the Monitor page.

```

                                Link Statistics

Number Of Unviewed Link Statistics..[101]
Jump To First Link Statistic.....J
View Next 5 Link Statistics.....V
Clear All Link Statistics.....C
Statistics Sample Interval (min)....[10].....I

Save Parameters to permanent storage.....S
Exit.....X
Telnet Logout.....L
v
22:27:00 29/10/14 Min Eb/No Loss Avg Eb/No Loss Max Power 0.0 Avg Power 0.0
22:37:00 29/10/14 Min Eb/No Loss Avg Eb/No Loss Max Power 0.0 Avg Power 0.0
22:47:00 29/10/14 Min Eb/No Loss Avg Eb/No Loss Max Power 0.0 Avg Power 0.0
22:57:00 29/10/14 Min Eb/No Loss Avg Eb/No Loss Max Power 0.0 Avg Power 0.0
23:09:35 29/10/14 Min Eb/No Loss Avg Eb/No Loss Max Power 0.0 Avg Power 0.0

                                Press Any Key to Continue

```

**Figure 9-42. Link Statistics**

Selection	Hot Key	Description
Number of Unviewed Link Statistic	[RO]	Displays the total number of <i>unread</i> Link Statistics. As statistics groups are displayed, the counter decrements accordingly.
Jump To First Link Statistic	J	Upon selection, sets the listings for Hot Key 'V' to the first link statistic that was stored subsequent to the latest buffer reset.
View Next 5 Link Statistics	V	Buffers the next group of five stored link statistics into the events window. Information is presented as shown in <b>Figure 9-42</b> .
Clear All Link Statistics	C	Erases all entries from the Link Statistics logging buffer.
Statistics Sample Interval (min)	I	Select a time interval, in minutes, in which the modem is polled for link statistics: 1 - 10 2 - 20 3 - 30 4 - 40 5 - 50 6 - 60 7 - 70 8 - 80 9 - 90 10 - Off

### 9.3.8.2.3 Satellite Modem > Monitor > BUC Status

Open the nested BUC Status page from the Monitor page.

```

Block Up Converter(BUC) Status

BUC Voltage (volts).....[00.0]
BUC Current (mA).....[0000]
BUC Software Version.....[00]
BUC Temperature (deg C).....[-99]
BUC PLL Alarm.....[Not Available]
```

**Figure 9-43. BUC Status**

Selection	Hot Key	Description
BUC Voltage (volts)	[RO]	Displays voltage, in volts.
BUC Current (mA)	[RO]	Displays current, in milliamps, from 0 to 4000.
BUC Firmware Version	[RO]	Displays the unit running firmware version.
BUC Temperature (deg C)	[RO]	Displays the unit temperature, in degrees Celsius.
BUC PLL Alarm	[RO]	Displays the Phase Lock Loop alarm status (e.g., Locked, Unlocked).

### 9.3.8.2.4 Satellite Modem > Monitor > LNB Monitor

Open the nested LNB page from the Monitor page.

```

LNB Monitor (Per LNB)

LNB Voltage (volts).....[13.1]
LNB Current (mA).....[001]
```

**Figure 9-44. LNB Monitor (Per LNB)**

Selection	Hot Key	Description
LNB Voltage (volts)	[RO]	Displays voltage, in volts.
LNB Current (mA)	[RO]	Displays current, in milliamps, from 0 to 4000.

### 9.3.8.2.5 Satellite Modem > Monitor > CnC Monitor

Open the nested CnC Monitor page from the Monitor page.

```

CnC Monitor
-----
CnC Ratio Monitor                Not Locked or CnC not enabled
CnC Delay Monitor                Not Locked or CnC not enabled
CnC Freq Offset Monitor          Not Locked or CnC not enabled
CnC Power Ratio Monitor          Not Locked or CnC not enabled
CnC PSDR                         Not Locked or CnC not enabled
CnC-APC Bit Error Rate           Sync Error or CnC-APC not enabled
CnC-APC Frame Error Rate         Sync Error or CnC-APC not enabled
CnC-APC State (see remote spec for detail) 99

                                Press Any Key to Continue
  
```

Figure 9-45. CnC Monitor

### 9.3.8.3 Satellite Modem > Information

Open the nested Information page from the Satellite Modem page.

```

Modem Information
-----
Model Number                      CDM-570AL
Turbo Option                       TPC/LDPC Installed
RS Codec Option                    Installed
WaD Option                         None
Data Rate Option                   Up to 10239.0 kbps
Higher-order Modulation            8-PSK/8-QAM and 16QAM
BUC Option                         None
Software Revision                  Boot:1.1.1 Bulk1:1.2.0 Bulk2:1.2.0
Active Image                       Bulk2
Serial Number                       100000000
Circuit ID                          CEFD CDM570AL AUDIT UNIT
Redundancy State                   Online

                                Press Any Key to Continue
  
```

Figure 9-46. Satellite Modem Information

### 9.3.8.4 Satellite Modem > Utilities

Open the nested Utilities page from the Satellite Modem page.

```

Modem Utilities
Time.....[15:01:05].....T
Date.....[21/10/06].....D
Circuit ID.....[-----].....I
Local/Remote State.....[Local].....R
Compatibility Mode.....[CDM-570A Mode].....C
Demo Mode.....[Disabled].....M
Load Configuration.....G
Store Configuration.....O
CarrierID Configuration.....A

Save Parameters to permanent storage.....S
Exit.....X
Telnet Logout.....L

```

**Figure 9-47. Satellite Modem > Utilities**

Selection	Hot Key	Description
Time	T	Set the time in MM:HH:SS format.
Date	D	Set the date in DD/MM/YY format.
Circuit ID	I	Set a 24-character Circuit ID (unit label). Allowable characters are: [Space] ( ) * + - . / 0 through 9 and A through Z
Local/Remote State	R	Select the operating state: 1 – Local 2 – Remote-Serial 3 – Remote-Ethernet
Compatibility Mode	C	Select the Compatibility Mode: 1 – CDM-570 Mode 2 – CDM-570A Mode
Demo Mode	M	Select the Demo Mode: 1 – Disabled 2 – Enabled 3 – Expired The time remaining for the 30-day demonstration period decrements until the time is Expired.
Load Configuration	G	Load or Store (save) one of 10 different modem configurations – 0 through 9.
Store Configuration	O	
Carrier ID Configuration	A	Select to configure the Carrier ID. See Section 0.

### 9.3.8.4.1 Satellite Modem > Utilities > Carrier ID Configuration



Note that in accordance with the DVB specification, Carrier ID is only available when the Transmit symbol rate is greater than, or equal to 128 kbps.

```

CarrierID Configuration
Embed CarrierID....[Enabled].....E
Latitude.....[33deg25.43minN].....T
Longitude.....[111deg58.28minW].....G
Phone.....[+18664723963].....P
CarrierID Message..[Contech EFData].....M

Save Parameters to permanent storage.....S
Exit.....X
Telnet Logout.....L
    
```

Figure 9-48. Carrier ID Configuration

Selection	Hot Key	Description
Embed Carrier ID	E	Toggle [Enabled] or [Disabled]
Latitude	T	Select to edit Latitude.
Longitude	G	Select to edit Longitude.
Phone	P	Select to edit phone number.
Carrier ID Message	M	Select to edit Carrier ID message.

### 9.3.9 Redundancy Configuration



#### Appendix N. IP REDUNDANCY

Open the Redundancy Configuration page from the Main Menu.

```

1:1 Redundancy Configuration

1:1 Redundancy.....[Enabled].....R
1:1 Redundancy State.....[Online]
Traffic IP Address.....[192.168.1.50].....T
Traffic Subnet Prefix Length.....[ 24  ].....M
Management IP Address (Local Unit).....[192.168.1.17]
Management Subnet Prefix Length (Local Unit).....[ 24  ]
Management IP Address (Redundant Unit).....[192.168.1.52]
Management Subnet Prefix Length (Redundant Unit)..[ 24  ]
Force Unit Offline.....F
Redundancy Mode.....[Auto].....A
    
```

**Figure 9-49. 1:1 Redundancy Configuration**

Selection	Hot Key	Description
1:1 Redundancy	R	Toggle [Enabled] or [Disabled]. <b>NOTE:</b> Only enable Redundancy when connected with another CDM-570A/570AL via a CRS-180 or CRS-170A redundancy switch.
1:1 Redundancy State	[RO]	<ul style="list-style-type: none"> <li>If standalone CDM-570A/570AL – displays state as Online.</li> <li>If Redundant CDM-570A/570AL – displays state as Online or Offline</li> </ul>
Traffic IP Address	[RO]	<ul style="list-style-type: none"> <li>If standalone CDM-570A/570AL – not used.</li> <li>If Online Redundant CDM-570A/570AL – sets Traffic IP (read/write).</li> <li>If Offline Redundant CDM-570A/570AL – displays Traffic IP (read-only).</li> </ul>
Traffic Subnet Prefix Length	[RW] [RO]	<ul style="list-style-type: none"> <li>If standalone CDM-570A/570AL – not used.</li> <li>If Online Redundant CDM-570A/570AL – sets Traffic Subnet (read/write).</li> <li>If Offline Redundant CDM-570A/570AL – displays Traffic Subnet (read-only).</li> </ul>
Management IP Address (Local Unit)	[RO]	<ul style="list-style-type: none"> <li>If standalone CDM-570A/570AL – not used.</li> <li>If Online Redundant CDM-570A/570AL – displays Local Management IP</li> <li>If Offline Redundant CDM-570A/570AL – displays Local Management IP</li> </ul>
Management Subnet Prefix Length (Local Unit)	[RO]	<ul style="list-style-type: none"> <li>If standalone CDM-570A/570AL – not used.</li> <li>If Online Redundant CDM-570A/570AL – displays Local Management Subnet</li> <li>If Offline Redundant CDM-570A/570AL – displays Local Management Subnet</li> </ul>

Selection	Hot Key	Description
Management IP Address (Redundant Unit)	[RO]	<ul style="list-style-type: none"> <li>If standalone CDM-570A/570AL – not used.</li> <li>If Online Redundant CDM-570A/570AL – displays Redundant Management IP Address</li> <li>If Offline Redundant CDM-570A/570AL – displays Redundant Management IP Address</li> </ul>
Management Subnet Prefix Length (Redundant Unit)	[RO]	<ul style="list-style-type: none"> <li>If standalone CDM-570A/570AL – not used.</li> <li>If Online Redundant CDM-570A/570AL – displays Redundant Management Subnet</li> <li>If Offline Redundant CDM-570A/570AL – displays Redundant Management Subnet</li> </ul>
Force Unit Offline	F	When this is active, unit is currently the <i>Online</i> unit, select to force a switchover – i.e., place this unit into <i>Offline</i> (standby) mode.
Redundancy Mode	A	Toggle mode as [Auto] or [Manual].

### 9.3.10 Operations and Maintenance

Open the Operations and Maintenance page from the Main Menu.

```

Operations and Maintenance
Unit Uptime.....[0 days 0 hours 23 mins 19 secs]
Unit Information.....I
IP Module Boot From.....[Image 1].....B
Upgrade To.....[Oldest].....U
Base Modem Boot From.....[Image 2].....A
Codecast Multicast Address..[239.1.2.4].....M
PARAM Image.....[Image 1].....C
Statistics.....T
Event Log.....E
Database Operations.....D
Reset.....R
Diagnostics.....G
M&C Interface.....F

Save Parameters to permanent storage.....S
Exit.....X
Telnet Logout.....L

```

Figure 9-50. Operations and Maintenance



Selection	Hot Key	Description
Unit Uptime	[RO]	Displays – in days, hours, mins, and secs – the lapsed time since the modem and Packet Processor were last rebooted.
Unit Information	I	Displays the operating firmware information page.
IP Module Boot From	B	Select which Packet Processor firmware image (includes Application, FPGA, and FFPGA) is loaded upon bootup: 0 – Latest: Boot the newer firmware image based upon date. 1 – Image1: Boot the firmware image loaded into the first slot in permanent storage. 2 – Image2: Boot the firmware image loaded into the second slot in permanent storage.
Upgrade To	U	Select which Packet Processor or Base Modem firmware image (includes Application, FPGA, and FFPGA) is overwritten in the Firmware Update FTP process: 0 – Oldest: Updates the older firmware image based upon date. 1 – Image1: Updates the firmware image loaded into the first slot in permanent storage. 2 – Image2: Updates the firmware image loaded into the second slot in permanent storage.
Base Modem Boot From	A	Select which Base Modem firmware image is loaded upon bootup. The possible options are: 0 – Latest: Boot the newer firmware package based upon date. 1- Image1: Boot the firmware image loaded into the first slot in permanent storage. 2 – Image2: Boot the firmware image loaded into the second slot in permanent storage.
Codecast Multicast Address	M	Set the Multicast address used by VLOAD to upgrade the modem firmware and param file via streaming Multicast. Must match the address specified in VLOAD.
PARAM Image	C	Select the PARAM file that is loaded on bootup: 1 – Last saved Parameter file 2 -Factory – uses the internal, hard-coded factory default parameters.
Statistics	T	Displays the Statistics page.
Event Log	E	Displays the Event Log page.
Database Operations	D	Displays the Database Operations page.
Reset	R	Reboots the modem (including the Packet Processor). It has the same logical effect of power-cycling the unit.
Diagnostics	G	Displays the Diagnostics page.
M&C Interface	F	Allows base modem communications debugging.

### 9.3.10.1 Operations and Maintenance > Unit Information

Open the Unit Information page from the Operations and Maintenance page.

```

Operations and Maintenance

Unit Uptime.....[0 days 0 hours 27 mins 44 secs]
Unit Information.....I
IP Module Boot From.....[Image 1].....B
Upgrade To.....[Oldest].....U
Base Modem Boot From.....[Image 2].....A
Codecast Multicast Address..[239.1.2.4].....M
PARAM Image.....[Image 1].....C
Statistics.....T
Event Log.....E
Database Operations.....D
Reset.....R
Diagnostics.....G
M&C Interface.....F

Save Parameters to permanent storage.....S
Exit.....X
Telnet Logout.....L
i
System time is SAT OCT 21 15:18:08 2006

Temperature: 31 Celsius.
Booted using Bulk #1. Base modem booted using Base Bulk #2 <1.5.1>.
Installed CDM570A IP Module. Running FPGA Ver# 47, Date: 8252015
Using configuration parameters from PARAM.

Type      : Date      Time      : Name                : Rev      : Len
Boot      : 9/12/2016 15:43 : FW-0020788L         : 1.5.1c   : 1048576
IP Bulk #1 : 9/12/2016 15:43 : FW-0020782L         : 1.5.1c   : 4443872
IP Bulk #2 : 9/12/2016 15:43 : FW-0020782L         : 1.5.1c   : 4443872
EVENTLOG   : 10/21/2006 09:56 : eventlog            : 2.1.4    : 250880
PARAM      : 10/20/2006 15:57 : config              : 1.4.2    : 5308
BaseBoot   : 07/12/2013 ---   : FW-0020684-         : 1.1.1    : ----
Base Bulk #1 : 09/13/2016 ---   : FW-0020683K         : 1.5.1    : ----
Base Bulk #2 : 09/13/2016 ---   : FW-0020683K         : 1.5.1    : ----

Press Any Key to Continue
    
```

Figure 9-51. Unit Information

Info Set	Item	Description
1	System time	DAY MONTH DATE TIME (hh:mm:ss) YEAR
2	Temperature	Displays, in degrees Celsius, the unit temperature.
	Image # that the Packet Processor is currently booted from	By default displays Latest, unless "Packet Processor Boot From" is set to Image #1 or Image #2
	Image # that the base modem is currently booted from.	By default displays Latest, unless "Base Modem Boot From" is set to Image #1 or Image #2
	Parameter (PARAM) file that the Packet Processor is currently configured from	Displays PARAM file from Flash or Factory Default if no parameter file is found in flash memory.

Info Set	Item	Description
3	Currently Loaded Packet Processor and Base Modem firmware: <ul style="list-style-type: none"> <li>• Boot</li> <li>• IP Bulk #1</li> <li>• IP Bulk #2</li> <li>• EVENTLOG</li> <li>• PARAM</li> <li>• BaseBoot</li> <li>• Base Bulk #1</li> </ul> Base Bulk #2	<ul style="list-style-type: none"> <li>• Displays Build Date, CEFD FW#, Revision #, and size of each Packet Processor and Base Modem firmware file:</li> <li>• Boot file for the Packet Processor and the Base Modem.</li> <li>• Bulk file contains all of the SW files for the Packet Processor and Base Modem and there are two slots available.</li> <li>• Displays the date/time that the EVENTLOG file was last updated.</li> <li>• Displays the date/time that the PARAM1 file was last updated. Also shows what user interface was used to last update the PARAM file.               <ul style="list-style-type: none"> <li>○ From CLI, displays 'console'</li> <li>○ From Web, displays 'http'</li> <li>○ From Telnet, displays the Telnet user login name</li> <li>○ From SNMP, displays 'snmp'</li> </ul> </li> </ul>

### 9.3.10.2 Operations and Maintenance > Statistics Menu

Open the nested Statistics Menu page from the Operations and Maintenance page.

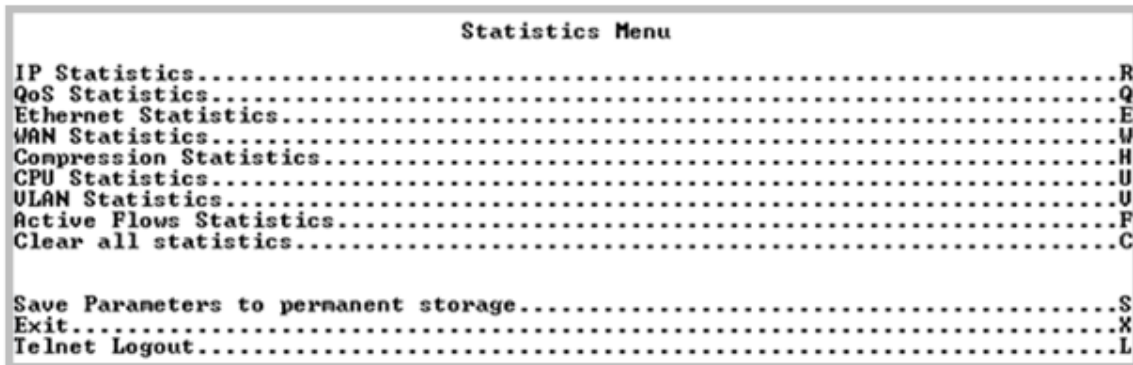

Figure 9-52. Statistics Menu



**All Statistics information refreshes once every 6 seconds.**

Selection	Hot Key	Description
IP Statistics	R	Displays and controls the statistics for IP Routing. See Section 9.3.10.2.1.
QoS Statistics	Q	Displays and controls the statistics for QoS. See Section 9.3.10.2.2.
Ethernet Statistics	E	Displays and controls the statistics for the Ethernet Port. See Section 9.3.10.2.3.
WAN Statistics	W	Displays and controls the statistics for the WAN (HDLC) Port. See Section 9.3.10.2.4.
Compression Statistics	H	Displays and controls the statistics for Header & Payload Compression. See Section 9.3.10.2.5.
CPU Statistics	U	Displays CPU Usage % (percentage). See Section 9.3.10.2.6.
VLAN Statistics	V	Displays and controls the statistics for the VLAN entries. See Section 9.3.10.2.7.
Active Flow Statistics	F	Displays the number of active output flows, output low overhead flows, and input flows. See Section 9.3.10.2.8.
Clear all statistics	C	Globally resets all statistics counters.

### 9.3.10.2.1 Operations and Maintenance > Statistics Menu> IP Statistics

Open the nested Statistics for IP Routing/EasyConnect page from the Statistics page. This page displays counts of the number of packets routed in the Packet Processor.

```

Statistics for IP Routing/EasyConnect

From Ethernet - Total.....[ 336 ]
To Ethernet   - Total.....[ 191 ]
To Ethernet   - Unicasts...[ 191 ]
To Ethernet   - Multicasts..[ 0 ]
To Ethernet   - Broadcasts..[ 0 ]
From Satellite - Total.....[ 0 ]
To Satellite   - Total.....[ 108 ]
To Satellite   - Unicasts...[ 11 ]
To Satellite   - Multicasts..[ 0 ]
To Satellite   - Broadcasts..[ 97 ]
From Endstation - Total.....[ 192 ]
To Endstation - Total.....[ 263 ]
Received IGMP Packets.....[ 0 ]
Received IP Options Packets....[ 0 ]
Reset All Counters.....C
Filter/Drop Statistics.....F

Save Parameters to permanent storage.....S
Exit.....X
Telnet Logout.....L

```

Figure 9-53. IP Routing Statistics

Selection	Hot Key	Description
From Ethernet – Total	[RO]	Ethernet Statistics Page, Rx Good Frames
To Ethernet – Total		Ethernet Statistics Page, Tx Good Frames
To Ethernet – Unicasts		Unicast packets to LAN
To Ethernet – Multicasts		Multicast packets to LAN
To Ethernet – Broadcasts		Broadcast packets to LAN
From Satellite – Total		WAN Statistics Page, Rx HDLC Packet Count
To Satellite – Total		WAN Statistics Page, Tx HDLC Packet Count
To Satellite – Unicasts		Unicast packets to WAN
To Satellite – Multicasts		Multicast packets to WAN
To Satellite – Broadcasts		Broadcast packets to WAN
From Endstation – Total		Packets sent from Packet Processor
To Endstation – Total		Packets directed to Packet Processor
Received IGMP Packets		Internet Group Management Packets received (used for management of Multicast traffic).
Received IP Options Packets	Number of IP Options packets received.	
Reset All Counters	C	Clears and resets all WAN, Ethernet and IP Routing statistics.
Filter/Drop Statistics	F	Displays the Filter Statistics page.

### 9.3.10.2.1.1 Operations and Maintenance > Statistics Menu> IP Statistics > Filter/Drop Statistics

Open the nested Filter/Drop Statistics page from the Statistics for IP Routing/EasyConnect page. This page displays counts of the number of packets filtered or dropped in the Packet Processor.

```

Filter Statistics
Filtered - Boot.....[ 1 ]
Filtered - Flow Descriptor.....[ 0 ]
Filtered - Unknown Reason Code.....[ 0 ]
Filtered - Flow Correlator.....[ 0 ]
Filtered - Management Path.....[ 0 ]
Filtered - Wan Scaling.....[ 0 ]
Filtered - Ping.....[ 0 ]
Filtered - Access Control.....[ 0 ]
Filtered - Uipersat MCP.....[ 0 ]
Filtered - Uipersat UCP.....[ 0 ]
Filtered - Codeload.....[ 0 ]
Filtered - Multicast.....[ 0 ]
Filtered - Bad Packet.....[ 0 ]
Filtered - Route.....[ 0 ]
Filtered - Uipersat Remote.....[ 0 ]
Filtered - QoS Rule.....[ 0 ]
Filtered - Uipersat Loop.....[ 0 ]
Filtered - Bad Header Len.....[ 0 ]
Filtered - Bad Data Ptr.....[ 0 ]
Filtered - MAC Split Err.....[ 0 ]
Filtered - L3Type Err.....[ 0 ]
Filtered - Local Destination.....[ 0 ]
Filtered - Redundancy Err.....[ 0 ]
Filtered - ICMP Filter.....[ 0 ]
Filtered - Port Err.....[ 0 ]
Filtered - Per port route rule.....[ 0 ]
Filtered - VLAN Mismatch.....[ 0 ]
Filtered - VLAN Tag/Untagging Failed.....[ 0 ]
Filtered - Dedicated Mgmt Access.....[ 0 ]
Filtered - Total.....[ 1 ]
Dropped - Bad IP Header Checksum.....[ 0 ]
Dropped - Bad Buffer Length.....[ 0 ]
Dropped - Bad IP Version.....[ 0 ]
Dropped - TTL Expired.....[ 0 ]
Dropped - No Route.....[ 0 ]
Dropped - No ARP Entry.....[ 0 ]
Dropped - Filtered Multicast.....[ 0 ]
Dropped - Multicast Disable Group.....[ 0 ]
Dropped - EasyConnect Multicast Option..[ 50 ]
Dropped - Router Queue Full.....[ 0 ]
Dropped - Total.....[ 50 ]
Reset All Counters.....C
Save Parameters to permanent storage.....S
Exit.....X
Telnet Logout.....L

```

Figure 9-54. Filter/Drop Statistics

Selection	Hot Key	Description
Reset All Counters	C	Clears and resets the Filter/Drop statistics buffer.

The page provides these read-only statistics for Filtered or Dropped Packets:

Packet Type	Feature	Description
Filtered	Boot	Packets are filtered while booting.
	Flow Descriptor	<ul style="list-style-type: none"> <li>• Packets are Filtered due to a Multicast packet classified as UNICAST packet.</li> <li>• Packets are filtered due to offline modem receiving packet from WAN port.</li> </ul>
	Unknown Reason Code	Packets dropping due to reasons not listed here.
	Flow Correlator	Packet are filtered due to improper establishing SAT-to-SAT traffic (This counter generally is seen on outbounding Hub modem in point-to-multipoint setup)
	Management Path	Not used.
	Wan scaling	Internal Error occurred during WAN scaling sub process in processing packet.
	Ping	Ping packets were received but PING feature was <b>Disabled</b> .
	Access Control	Packets are received while "Access List" control is <b>Enabled</b> but IP address does not match the access list database.
	Vipersat MCP	Internal Error occurred while processing Vipersat Multi-command messages.
	Vipersat UCP	Internal Error occurred while processing Vipersat Uni-command messages.
	Codeload	Internal error occurred while processing Codeload messages.
	Multicast	A Multicast packet is received but no application is associated with it.
	Bad Packet	Malformed packet is received. This may be due to internal or external error
	Route	Applies to Vipersat Remote only – when a packet is received from the WAN and the Route Table contains a route to transmit that packet to the WAN, the packet is filtered to prevent a routing loop.
	Vipersat Remote	Packets are filtered due to Vipersat Remote mode (a modem configured as a Vipersat Remote Expansion unit and default route set to 0.0.0.0/0).
	QoS Rule	Packet filtered due to QoS Rule configured to filter.
	Vipersat Loop	Packets are filtered due to WAN loop in Vipersat Remote mode
	Bad Header Len	Filtered due to packets received with less than 14 bytes of L2 header.
	Bad Data Ptr	Internal error occurred while accessing the packet data.
	MAC Split Err	Not currently used.
	L3Type Err	Not currently used.
	Local Destination	Packet received with destination MAC as modem MAC and destination IP is not modem IP while modem is operating in bridge mode (Managed Switch)
	Redundancy Err	Applies to Offline modem in 1:1 Redundancy Packets are received on the WAN port by the both Offline unit and Online unit, only Online unit is allowed to forward the packets. Indicates packets received by Offline unit from WAN port that were filtered because unit is Offline.
ICMP Filter	This is the same as "Filtered Ping", except this will update in Managed Switch mode.	
Port Err	Non-IP or ARP packets are targeted to End-station. (End-station will not allow any non-Packets).	

Packet Type	Feature	Description
Filtered (cont.)	Per port route rule	<ul style="list-style-type: none"> <li>In 1:1 Redundancy Managed Switch mode – a packet received with modem destination MAC, but the IP does not match the traffic IP or management IP.</li> <li>In Router mode – per port WAN filtered mode is ON.</li> </ul>
	VLAN Mismatch	Packets filtered due to VLAN Tag not matching the port's VLAN membership
	VLAN Tag/Untagging Failed	Packets filtered due to errors while tagging or untagging a packet.
	Total	Total Filtered Packets
Dropped	Bad IP Header Checksum	Total Dropped Packets due to incorrect IP Header Checksum.
	Bad Buffer Length	IP length (as specified in packet header) was greater than payload received in the Ethernet packet. This would indicate the packet was truncated before arriving.
	Bad IP Version	Total Dropped IP Version 6 Packets (Packet Processor only supports IP Version 4).
	TTL Expired	Total Dropped Packets due to Time To Live counter expired (TTL limits the number of hops, or seconds, before a packet reaches its destination).
	No Route	Total Dropped Packets due to no Route for the destination in the Packet Processor Route Table. These are packets that are directed to the Packet Processor's MAC address and the Packet Processor will reply to the sender with an ICMP 'Destination net unreachable' message.
	No ARP Entry	Total Dropped Packets due to no ARP entry in Packet Processor ARP Table. <b>For example</b> , if an Packet Processor receives packets from the satellite for a host that is not in the ARP table, the Packet Processor will send an ARP request. If there is no response, the packets are dropped.
	Filtered Multicast	Total Dropped Multicast Packets received from the satellite due to no SAT→LAN or
	Multicast Disable Group	Multicast packet was dropped because, although route existed, IGMP is being used, and there is no client requesting forwarding of this traffic or due to an IGMP "leave group" message.
	EasyConnect Multicast Option	Total Dropped Multicast Packets received from the satellite due to the 'Managed Switch Multicast Option' feature not being <b>Enabled</b> in Managed Switch Mode.
	Router Queue Full	Indicates that the router task is dropping packets due to being full. Represents a graceful drop process when the processor performance is being overdriven.
	Total	Total Dropped Packets



### 9.3.10.2.2 Operations and Maintenance > Statistics Menu> QoS Statistics

Open the nested QoS Statistics page from the Statistics page. This page displays the statistics for the number of Packets routed, based upon the defined QoS Rules, by the Packet Processor.

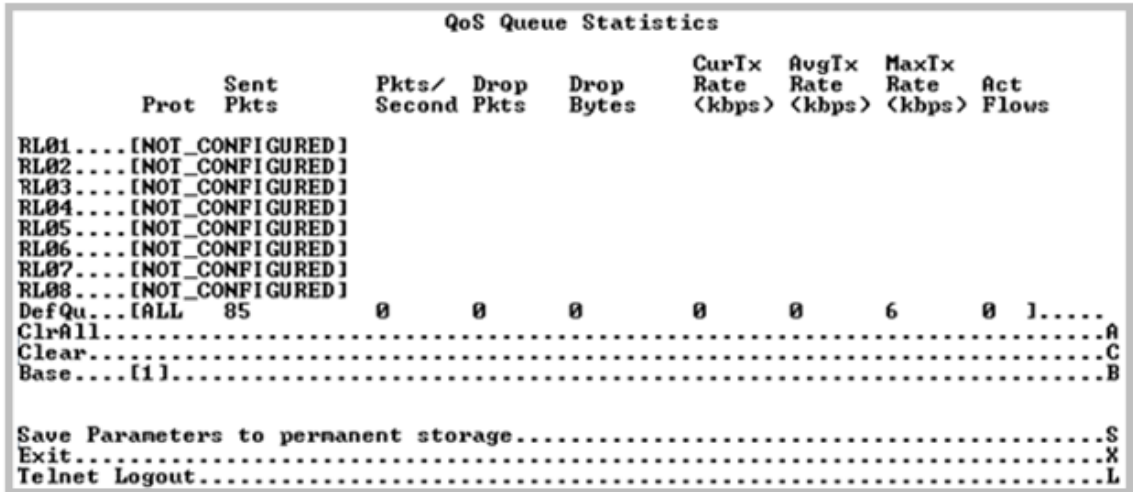

Figure 9-55. QoS Statistics



In DiffServ QoS Mode, statistics for the various DiffServ DSCP Classes are in the following Queues:

Queue01	Expedited Forwarding
Queue02	Class 1 Precedence
Queue03	Class 2 Precedence
Queue04	Class 3 Precedence
Queue05	Class 4 Precedence
Queue06	Class 5 Precedence
Queue07	Class 6 Precedence
Queue08	Class 7 Precedence
Queue09	Assured Forwarding Class 1
Queue10	Assured Forwarding Class 2
Queue11	Assured Forwarding Class 3
Queue12	Assured Forwarding Class 4

Selection	Hot Key	Description
ClrAll	A	Clears all QoS statistics and resets the buffer.
Clear	C	Allows a reset of the statistics in a specific Queue.
Base [#]	B	Select Base and then type a number to display a different set of eight of up to 32 available queues. For example, if you want to view QoS Queues 16-24: Type '16'.

### 9.3.10.2.3 Operations and Maintenance > Statistics Menu > Ethernet Statistics

Open the nested Ethernet Statistics page from the Statistics pages. These read-only pages present the total packets received and transmitted for the Ethernet Port of the Packet Processor.

```

                                Ethernet Statistics
Ethernet Port.....[Traffic Port].....P
Total Pkts Received.....[    358]
Rx Unicast Pkts.....[    203]
Rx Broadcast Pkts.....[     99]
Rx Multicast Pkts.....[     56]
Rx Pause Frames.....[      0]
Bytes Received.....[  34583]
Total Receive Errors.....[      0]
Rx Current Data Rate.....[      0]
Rx Average Data Rate.....[      0]
Rx Maximum Data Rate.....[      8]
Rx Current Pkt Rate.....[      1]
Rx Average Pkt Rate.....[      0]
Rx Maximum Pkt Rate.....[      8]

                                Press Any Key to Continue
  
```

Figure 9-56. Ethernet Statistics – Initial Page

When **P** is selected, the screen provides additional information:

```

                                Ethernet Statistics
Ethernet Port.....[Traffic Port].....P
Total Pkts Received.....[ 358]
Rx Unicast Pkts.....[ 203]
Rx Broadcast Pkts.....[ 99]
Rx Multicast Pkts.....[ 56]
Rx Pause Frames.....[ 0]
Bytes Received.....[ 34583]
Total Receive Errors.....[ 0]
Rx Current Data Rate.....[ 0]
Rx Average Data Rate.....[ 0]
Rx Maximum Data Rate.....[ 0]
Rx Current Pkt Rate.....[ 1]
Rx Average Pkt Rate.....[ 0]
Rx Maximum Pkt Rate.....[ 8]

                                Press Any Key to Continue

pTotal Pkts Transmitted..[ 228]
Tx Unicast Pkts.....[ 228]
Tx Broadcast Pkts.....[ 0]
Tx Multicast Pkts.....[ 0]
Tx Pause Frames.....[ 0]
Bytes Transmitted.....[ 67590]
Tx Current Data Rate.....[ 0]
Tx Average Data Rate.....[ 0]
Tx Maximum Data Rate.....[ 26]
Tx Current Pkt Rate.....[ 1]
Tx Average Pkt Rate.....[ 0]
Tx Maximum Pkt Rate.....[ 12]

                                Press Any Key to Continue

```

Figure 9-57. Ethernet Statistics – Expanded Page

### 9.3.10.2.4 Operations and Maintenance > Statistics Menu> WAN Statistics

Open the nested WAN Statistics page from the Statistics page. This page displays counts of the number of packets routed or dropped in the Packet Processor Satellite interface.

```

WAN Statistics
WAN Rx Bad Addr Count.....[0      ]
WAN Rx Pkt Proc CRC Error Count.....[0      ]
WAN Rx Abort/Octet Error Count.....[0      ]
WAN Rx Overrun Count.....[0      ]
WAN Rx HDLC CRC Error Count.....[0      ]
WAN Rx HDLC Payload Bytes.....[0      ]
WAN Rx HDLC Header Bytes.....[0      ]
WAN Rx HDLC Packet Count.....[0      ]
WAN Rx HDLC HW Payload Bytes.....[0      ]
WAN Rx HDLC HW Header Bytes.....[0      ]
WAN Rx HDLC HW Packet Count.....[0      ]
WAN Rx HDLC Address Match Packet Count.....[0      ]
WAN Rx HDLC Address Filtered Packet Count.....[0      ]
WAN Rx Err Invalid Flow Id.....[0      ]
WAN Rx Err SAR Reassemble.....[0      ]
WAN Rx Err Hdr Decompress.....[0      ]
WAN Rx Err Mem Alignment.....[0      ]
WAN Rx Err Bad Crc.....[0      ]
WAN Rx DMA Reclaim.....[0      ]

WAN Tx Err - No Flow.....[0      ]
WAN Tx Err - No Route.....[0      ]
WAN Tx Err - Pkt Start.....[0      ]
WAN Tx Err - Pkt Front Length.....[0      ]
WAN Tx Err - Pkt End Length.....[0      ]
WAN Tx Err - Pkt Invalid Length.....[0      ]
WAN Tx Err - Pkt Dropped - Sat overdriven.....[0      ]
WAN Tx DMA Reclaim.....[0      ]
WAN Tx HDLC Header Bytes.....[520    ]
WAN Tx HDLC Payload Bytes.....[14832  ]
WAN Tx HDLC Packet Count.....[130    ]
WAN Utilization.....[0      ]
Ethernet traffic destined to go over WAN (kbps).....[0      ]
Actual Satellite traffic (kbps).....[0      ]
Percentage of WAN Bandwidth saved.....[0      ]
CLEAR.....C

Save Parameters to permanent storage.....S
Exit.....X
Telnet Logout.....L

```

Figure 9-58. WAN Statistics

Selection	Hot Key	Description
CLEAR	C	Clears and resets the WAN statistics buffer.

The page provides these read-only statistics:

Item	Description
WAN Rx Bad Addr Count	Packets dropped due to HDLC Address mismatch
WAN Rx Pkt Proc CRC Error Count	Count of received frames that failed packet processor CRC check. Indicates that a Payload Compressed Packet was received that could not be decompressed.
WAN Rx Abort/Octet Error Count	Count of aborted frames and octet error frames.
WAN Rx Overrun Count	Count of received frames that exceeded max frame length of 2K bytes in length (Or) overflowed the HDLC buffer.
WAN Rx HDLC CRC Error Count	Number of received frames that failed HDLC CRC check. Indicates that a corrupted packet was received and is usually due to a marginal satellite link.

Item	Description
WAN Rx HDLC Payload Bytes	The count of payload bytes that were received over satellite link excluding any frame overhead.
WAN Rx HDLC Header Bytes	The count of HDLC header bytes received over satellite link including control, HDLC address, Flow ID, and CRC.
WAN Rx HDLC Packet Count	Number of packets received over satellite link.
WAN Rx HDLC HW Payload Bytes	Payload Bytes received by WAN Receive Interface (Hardware)
WAN Rx HDLC HW Header Bytes	HDLC Header Bytes received by WAN Receive Interface (Hardware)
WAN Rx HDLC HW Packet Count	Number of packets received by WAN Receive Interface (Hardware)
WAN Rx HDLC Address Match Packet Count	Number of packets received that matched any of the 4 RX HDLC Addresses defined in the Satellite interface (not used with version 1.7.# and later).
WAN Rx HDLC Address Filtered Packet Count	Number of packets received that did not match any of the 4 RX HDLC Addresses defined in the Satellite interface (not used with version 1.7.# and later).
WAN Rx Err Invalid Flow ID	Number of packets which the flow identifier has been corrupted, does not fall into the range of acceptable values.
WAN Rx Err SAR Reassemble	Number of packets unable to correctly reassemble a segmented packet.
WAN Rx Err Hdr Decomp	Number of packets unable to correctly decompress the header information.
WAN Rx Err Mem Alignment	Number of packets discarded (caused by memory corruption).
WAN Rx Err Bad Crc	Number of corrupted packets indicated by CRC check.
WAN Rx DMA Reclaim	Number of times Receive DMA Reclaim Errors have occurred.
WAN TX Err – No Flow	Number of packets dropped due to missing flow association.
WAN TX Err – No Route	<b>Internal Traffic Statistics used for Factory Troubleshooting</b>
WAN TX Err – Pkt Start	
WAN TX Err – Pkt Front Length	
WAN TX Err – Pkt End Length	
WAN TX Err – Pkt Invalid Length	
WAN TX Err – PktDropped – Sat overdriven	
WAN Tx DMA Reclaim	Number of times Transmit DMA Reclaim Errors have occurred.
WAN Tx HDLC Header Bytes	This counter keeps track of number of HDLC header bytes transmitted over satellite link.
WAN Tx HDLC Payload Bytes	Number of payload bytes transmitted over satellite link.
WAN Tx HDLC Packet Count	Count of packets transmitted over satellite link.
WAN Utilization	Percentage of current TX data rate being used for IP traffic (after compression and framing)
Ethernet traffic destined to go over WAN (kbps)	Bandwidth required to forward Ethernet traffic before compression.
Actual Satellite traffic (kbps)	Current satellite bandwidth being used.
Percentage of WAN Bandwidth saved	Displays percent of bandwidth being saved as a result of Header and/or Payload Compression, and optimized satellite framing.

### 9.3.10.2.5 Operations and Maintenance > Statistics Menu > Compression Statistics

Open the nested Compression Statistics page from the Statistics page. This page displays counts of the number of bytes before and after Header and Payload Compression. For Header Compression, the percentage of bandwidth savings displays. For Payload Compression, the effective compression ratio displays.

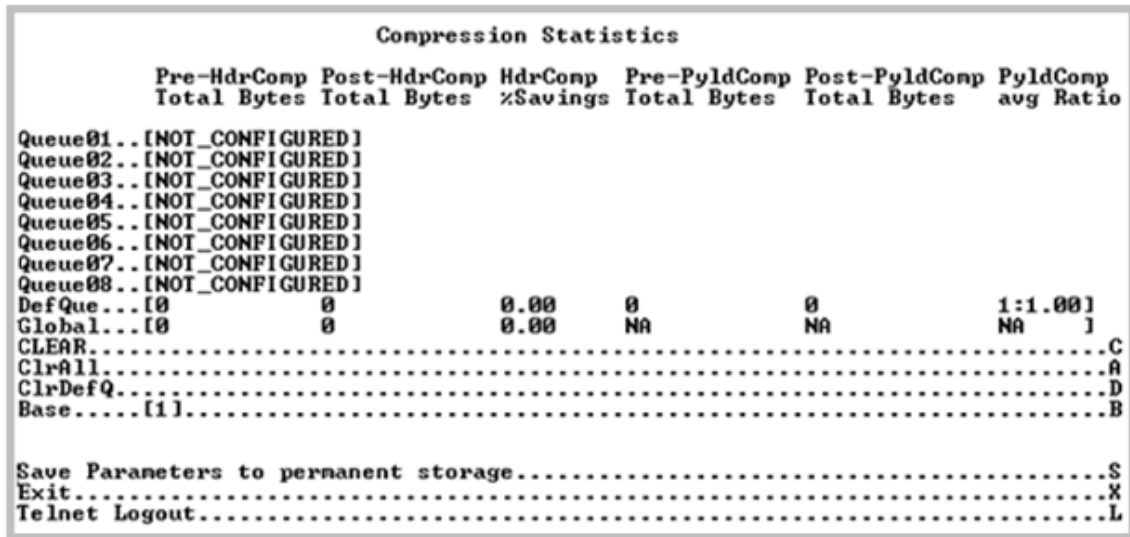

Figure 9-59. Compression Statistics



Although the QoS option is not required to use Header or Payload Compression, the Compression Statistics are displayed by QoS Rule flow Queues. If QoS is not Enabled, all the Compression Statistics will fall within the Global Queue.

Selection	Hot Key	Description
Queue01 through Queue32	[RO]	Displays statistics, in groups of eight queues per screen, in table format showing, by column: <ul style="list-style-type: none"> <li>Pre-Header Comp Bytes</li> <li>Post-Header Comp Bytes</li> <li>Header Comp % Savings</li> <li>Pre-Payload Comp Bytes</li> <li>Post-Payload Comp Bytes</li> <li>Payload Compression Ratio</li> </ul>
DefQue	[RO]	Compression Statistics of packets traversed through Default QoS Queue.
Global	[RO]	All traffic that does not fall within a defined QoS Rule is indicated in the 'Global' (Default Rule Queue).
CLEAR	C	Allows a reset of the statistics of a specific rule index.
ClrAll	A	Resets all Compression Statistics.
ClrDefQ	D	Clear the Compression statistics of Default QoS Queue.
Base [#]	B	Select Base and then type a number to display a different set of eight of up to 32 available queues. <b>For example</b> , if you want to view Queues 16-24: Type '16'.

### 9.3.10.2.6 Operations and Maintenance > Statistics Menu> CPU Statistics

Open the nested CPU Statistics page from the Statistics page. This page displays Packet Processor CPU Utilization as a percentage(%).

```

CPU Statistics

CPU Usage (% Percentage)..[4]

Save Parameters to permanent storage.....S
Exit.....X
Telnet Logout.....L
    
```

Figure 9-60. CPU Statistics

### 9.3.10.2.7 Operations and Maintenance > Statistics Menu> VLAN Statistics

Open the nested VLAN Statistics page from the Statistics page. This page displays VLAN packets to and from the WAN (satellite) and to and from Ethernet (LAN) by VLAN ID. It also displays VLAN packets from and to the Management VLAN of the Packet Processor.

```

VLAN Statistics

ID      to-WAN  from-WAN  to-Eth  from-Eth
VLANStat01.....[ 1      0      0      0].....1
VLANStat02.....[ 1      0      0      0].....2
VLANStat03.....[UNKNOWN].....3
VLANStat04.....[UNKNOWN].....4
VLANStat05.....[UNKNOWN].....5
VLANStat06.....[UNKNOWN].....6
VLANStat07.....[UNKNOWN].....7
VLANStat08.....[UNKNOWN].....8
From Management VLAN..[ 0 ]
To Management VLAN...[ 0 ]
Clear.....C
Base.....[1].....B

Save Parameters to permanent storage.....S
Exit.....X
Telnet Logout.....L
    
```

Figure 9-61. VLAN Statistics

Selection	Hot Key	Description
Clear	C	Allows a reset of the Statistics of a specific Queue.
Base [#]	B	Select Base and then type a number to display a different set of eight of up to 32 available entries. For example, if you want to view VLANStats 16-24: Type '16'.

### 9.3.10.2.8 Operations and Maintenance > Statistics Menu> Active Flow Statistics

```

Active Flows Statistics
Number of Active Output Flows.....[6]
Number of Active Output Low Overhead Flows..[0]
Number of Active Input Flows.....[0]

Save Parameters to permanent storage.....S
Exit.....X
Telnet Logout.....L
  
```

Figure 9-62. Active Flow Statistics

### 9.3.10.3 Operations and Maintenance > Event Log

Open the nested Event Log page from the Operations and Maintenance page. Use this page to view all logged Packet Processor events.

```

Event Log
Logging Feature..[Enabled].....F
Logging Level....[All Information].....E
View Log.....U
Clear Log.....C

Save Parameters to permanent storage.....S
Exit.....X
Telnet Logout.....L
  
```

Figure 9-63. Event Log

Selection	Hot Key	Description
Logging Feature	F	Toggle event logging as [Enabled] or [Disabled].
Logging Level	E	Select the type of reported information: 1 – Errors Only 2 – Errors and Warnings 3 – All Information
View log	V	Select to view the most recent events. The top of the screen displays the most recently logged event. As shown in the <b>Figure 9-63</b> example, the events log displays: <ul style="list-style-type: none"> <li>• <b>Type</b> – Error, Warning, or Information</li> <li>• <b>Date/Time</b> – NOTE: During bootup, multiple Boot Events are created, but a Date/Time will only be seen when the bootup has completed.</li> <li>• <b>Category</b> – Boot, Database, FTP logins, upgrade file transfers, Ethernet Link status change, Redundancy status.</li> <li>• <b>Description</b> – Event details</li> </ul> Press any key to scroll through events or [Esc] to exit.
Clear log	C	Select to clear log contents.



Select V to view the most recent events:

Type	Date	Time	Category	Description
Infor	10/21/2006	15:00:18	Telnet	Connected host 192.168.1.100
Infor	10/21/2006	14:59:01	Telnet	Telnet disconnected
Infor	10/21/2006	14:51:08	Telnet	Connected host 192.168.1.100
Infor	10/21/2006	14:50:21	Boot	Configuring router using PARAM file
Infor	10/21/2006	14:50:21	Boot	System booted at SAT OCT 21 14:50:20 2006
Infor	10/21/2006	09:58:33	Telnet	Connected host 192.168.1.100
Infor	10/21/2006	09:56:15	Telnet	Telnet disconnected
Infor	10/21/2006	09:31:57	Telnet	Connected host 192.168.1.100
Infor	10/21/2006	09:11:58	Telnet	Telnet disconnected
Infor	10/21/2006	09:06:25	Telnet	Connected host 192.168.1.100
Infor	10/21/2006	09:05:30	Telnet	Telnet disconnected
Infor	10/21/2006	08:54:59	Telnet	Connected host 192.168.1.100
Infor	10/21/2006	08:50:47	Telnet	Telnet disconnected
Infor	10/21/2006	08:39:08	Telnet	Connected host 192.168.1.100
Infor	10/21/2006	08:36:35	Boot	Configuring router using PARAM file
Infor	10/21/2006	08:36:35	Boot	System booted at SAT OCT 21 08:36:34 2006
Infor	10/20/2006	16:12:42	Telnet	Connected host 192.168.1.100

Press Any Key to Continue

Figure 9-64. Event Log – View Log



**The full Event log file can be retrieved by FTP. Use Admin login, then Set the command 'get eventlog'. The entire Event log can then be viewed with a text viewer, as per the following example:**

```

54      Information      05/21/2004 10:12:04 C:/Comtech/ftp/ftpCallbacks.c
1041   FTP                FTP Connected - 'User: comtech' logged in

53      Information      05/21/2004 09:07:40 C:/Comtech/cimmib/cimMib.c
520    Database         Set system clock to FRI MAY 21 09:07:40 2004

52      Information      Unknown      Unknown    C:/Comtech/startup/usrAppInit.c
534    Boot              Configuring router using PARAM file

51      Information      Unknown      Unknown    C:/Comtech/startup/usrAppInit.c
364    Boot              Detected Frammer Module II.

50      Information      05/21/2004 08:57:42 C:/Comtech/cimmib/cimMib.c
520    Database         Set system clock to FRI MAY 21 08:57:42 2004

49      Information      Unknown      Unknown    C:/Comtech/startup/usrAppInit.c
534    Boot              Configuring router using PARAM file

48      Information      Unknown      Unknown    C:/Comtech/startup/usrAppInit.c
364    Boot              Detected Frammer Module II.

47      Information      05/21/2004 08:13:02 C:/Comtech/ftp/ftpCallbacks.c
180    FTP                Disconnected FTP

46      Information      05/21/2004 07:58:06 C:/Comtech/ftp/ftpCallbacks.c
540    FTP                FTP Transfer complete

45      Information      05/21/2004 07:58:04 C:/Comtech/ftp/ftpCallbacks.c
863    FTP                Image has been saved to FLASH

44      Information      05/21/2004 07:57:40 C:/Comtech/ftp/ftpCallbacks.c
1041   FTP                FTP Connected - 'User: comtech' logged in

43      Information      05/21/2004 06:55:14 C:/Comtech/Telnetd/Telnetd.c
421    Telnet            Telnet disconnected

42      Information      05/21/2004 06:54:26 C:/Comtech/Telnetd/Telnetd.c
385    Telnet            Connected host 10.6.6.94

41      Information      05/21/2004 06:38:02 C:/Comtech/ftp/ftpCallbacks.c
180    FTP                Disconnected FTP

40      Information      05/21/2004 06:23:07 C:/Comtech/ftp/ftpCallbacks.c
540    FTP                FTP Transfer complete

39      Information      05/21/2004 06:23:06 C:/Comtech/ftp/ftpCallbacks.c
863    FTP                Image has been saved to FLASH

```

### 9.3.10.4 Operations and Maintenance > Database Operations

Open the nested Database Operations page from the Operations and Maintenance page. Use this page to view, save, or erase an existing user configuration of the Packet Processor. An Packet Processor uses these types of configuration files to initialize itself on power-up.

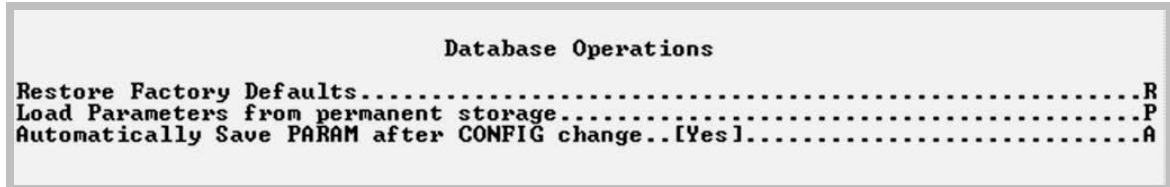

**Figure 9-65. Database Operations**

The modem uses the User Configuration File to overwrite the values defined in the Factory Configuration file. This allows full customization of an Packet Processor without erasing the factory-defined parameters set.



**The User Configuration File can also be retrieved or overwritten via FTP by specifying the filename 'param1'.**

Selection	Hot Key	Description
Restore Factory Default	R	Restores the Packet Processor configured settings to "safe" values as established at the factory.
Load Parameters from permanent storage	P	If you answer "Y" from the prompt, "Are you sure you want to load parameters [Y/N]?", this overwrites the current configuration of the Packet Processor with the configuration last saved to permanent storage. This performs an "undo" type operation if the user puts the Packet Processor into an undesirable state.
Automatically Save PARAM after CONFIG change	A	Toggle "Yes" to automatically save any configuration changes, including changes made from the modem front panel.

### 9.3.10.5 Operations and Maintenance > Diagnostics

Open the nested Diagnostics Page from the Operations and Maintenance page.

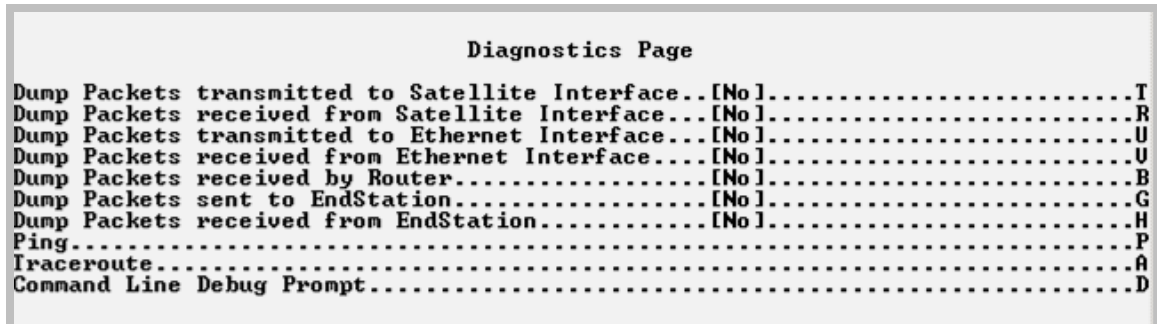

Figure 9-66. Diagnostics



#### Using Dump Packets Diagnostics Utilities

1. The Dump Packet Utilities will display a hexadecimal representation of each packet and should not be used when the Packet Processor is on a “live” network.
2. Type the Hot Key a second time to terminate the dump operation. Each selection toggles the value of the dump engine.

Selection	Hot Key	Description
Dump Packets transmitted to Satellite Interface	T	Toggle [Yes] to force the Packet Processor to dump a hexadecimal representation of each packet transmitted over the Satellite Interface.
Dump Packets received from Satellite Interface	R	Toggle [Yes] to force the Packet Processor to dump a hexadecimal representation of each packet received from the Satellite Interface.
Dump Packets transmitted to Ethernet Interface	U	Toggle [Yes] to force the Packet Processor to dump a hexadecimal representation of each packet transmitted to the Ethernet Interface.
Dump Packets received from Ethernet Interface	V	Toggle [Yes] to force the Packet Processor to dump a hexadecimal representation of each packet received from the Ethernet Interface.
Dump Packets received by Router	B	Toggle [Yes] to force the Packet Processor to dump a hexadecimal representation of each packet received by the routing engine. <b>Note:</b> Does not apply when in Managed Switch Mode.
Dump Packets sent to EndStation	G	Toggle [Yes] to force the Packet Processor to dump a hexadecimal representation of each packet received by and destined for this modem. This traffic includes Pings, SNMP, Telnet, HTTP, and FTP traffic types.
Dump Packets received from EndStation	H	Toggle [Yes] to force the Packet Processor to dump a hexadecimal representation of each packet sourced from this modem and destined for some other device. Select this to see what type of packets this modem is generating internally.
Ping	P	Set the IP address in aaa.bbb.ccc.ddd format, set the number of pings to be sent. Reports percentage of packet loss and round trip time (RTT) in msec (min/avg/max).
Traceroute	A	Set the IP address in aaa.bbb.ccc.ddd format. Reports min/avg/max RTT for each hop in path.
Command Line Debug Prompt	D	This is reserved for Customer Service and engineering use. Type your password to access the debug command line.

# Chapter 10. ODU (TRANSCEIVER, BUC, LNB) M&C OPERATIONS

---

## 10.1 Overview



Unless otherwise specified, this chapter uses “CDM-570A/570AL” to refer to the CDM-570A (70/140 MHz) and CDM-570AL or CDMR-570AL (L-Band) Satellite Modems.

The CDM-570A/570AL Satellite Modem permits configuration, monitoring, and control of Comtech EF Data Outdoor Units (ODUs) either in standalone or 1:1 redundant configuration.

**These ODUs are compatible under CDM-570A (70/140 MHz) operation:**

- **CSAT-5060** series (5 to 25, 50 & 100 Watts) C-Band Transceivers
- **KST-2000A** (LNA) Ku-Band Satellite Transceiver
- **KST-2000B** (LNB) Ku-Band Satellite Transceiver

**These ODUs are compatible under CDM/R-570AL (L-Band) operation:**

- Comtech EF Data Block Up Converter (BUC) products
- Comtech EF Data Low-Noise Block Down Converter (LNB) products

You can fully monitor and control ODU operations as follows:

- **By using the CDM-570A/570AL front panel keypad and VFD.** The Front Panel ODU menu branch allows you to configure power supplies, a 10 MHz reference, and low/high current alarm thresholds for the CDM/R-570AL BUC and LNB M&C. LO (Local Oscillator) menus allow you to set up the upconversion and downconversion settings for the BUC and LNB so that you can view the satellite frequencies as well as the modem IF input/output frequencies.
- **By using the CDM-570A HTTP (Web Server) Interface.**
- **By using the SNMP Interface** with the CDM-570A CSAT-5060 or KST-2000A/B Transceiver MIB, or the CDM/R-570AL BUC or LNB MIB.
- **By using Serial-based Remote Product Management** to issue ODU remote commands and queries.

## 10.1.1 CDM-570A/570AL Front Panel Operation – Overview



See Chapter 6. FRONT PANEL OPERATION for an in-depth explanation of the function and operation of the CDM-570A/570AL front panel.

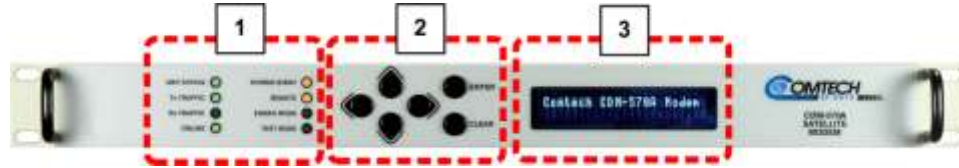

Figure 10-1. CDM-570A/570AL Front Panel Features

- 1 **LED Indicators**  
The LEDs show a summary status of modem operation. See **Sect. 6.1.1**.
- 2 **Keypad**  
The keypad has six individual keys. The keys have a positive ‘click’ action that gives tactile feedback. Use the keypad to enter data. See **Sect. 6.1.2**.
- 3 **Vacuum Fluorescent Display (VFD)**  
The VFD shows data, menus, prompts and messages. The VFD is an active display with adjustable brightness. It shows two lines of 40 characters each. Nested menus show all available options and prompts that guide you in carrying out required actions. See **Sect. 6.1.3**.

## 10.1.2 CDM-570A HTTP Interface – Overview



See Chapter 7. ETHERNET-BASED REMOTE PRODUCT MANAGEMENT for in-depth explanations of the function and operation of the CDM-570A HTTP Interface.

Ethernet-based Remote Product Management of the CDM-570A/570AL is available using one of two rear panel RJ-45 10/100 BaseT Ethernet ports:

- The ‘M&C 100’ 10/100 Ethernet port (for units without the optional IP Packet Processor)  
–or–
- The ‘Traffic 100’ 10/100 Ethernet port (for units equipped with the optional IP Packet Processor).

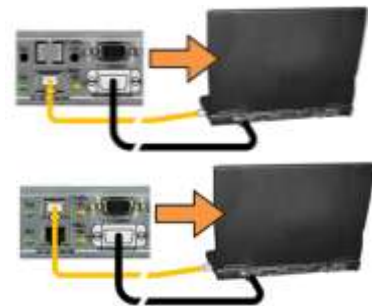

**YOU MAY PROCEED WITH ETHERNET-BASED REMOTE PRODUCT MANAGEMENT (WEB SERVER OR SNMP) UNDER THE ASSUMPTIONS THAT:**

- **A compatible ODU is connected to the CDM-570A/570AL.**
- **The CDM-570A/570AL is operating with the latest version firmware files.**
- **The CDM-570A/570AL is connected to a user-supplied, Windows-based PC, and:**

- **The PC serial port is connected to the CDM-570A/570AL rear panel 'Remote Control' port with a user-supplied 9-pin serial cable.**
- **The PC Ethernet port is connected to the CDM-570A rear panel 'M&C 100' 10/100 or 'Traffic 100' BaseT Ethernet port with a user-supplied hub, switch, or direct Ethernet cable connection.**
- **The user PC is running a terminal emulation program (for operation of the CDM-570A/570AL Serial Interface) and a compatible Web browser (for operation of the CDM-570A HTTP Interface).**
- **The CDM-570A/570AL Ethernet Traffic IP Address has been noted and the firmware has been identified using either the CDM-570A/570AL Serial Interface or the CDM-570A HTTP Interface 'Configuration | LAN' and 'Admin | Firmware' pages, respectively.**

### 10.1.3 CDM-570A/570AL Serial Remote Control – Overview



See Chapter 8. SERIAL-BASED REMOTE PRODUCT MANAGEMENT for an in-depth explanation of the use of remote commands and queries over the CDM-570A/570AL Serial Remote Control Interface.

The CDM-570A/570AL Satellite Modem's serial remote product management interface is an electrical interface that is either an EIA-485 multi-drop bus (for the control of multiple devices) or an EIA-232 connection (for the control of a single device). The interface uses ASCII characters in asynchronous serial form to transmit data between the Controller (e.g., a User PC) and Target (e.g., the modem and ODU). This data consists of control and status information, transmitted in packets of variable length in accordance with the structure and protocol explained in detail in Chapter 8.

The Controller is in charge of the process of monitor and control, and is the only device that is permitted to initiate, at will, the transmission of data. Targets are only permitted to transmit when they have been specifically instructed to do so by the Controller.

The exchange of information is transmitted, Controller-to-Target and Target-to-Controller, in 'packets'. Each packet contains a finite number of bytes consisting of printable ASCII characters, excluding ASCII code 127 (DELETE).

In this context, the Carriage Return and Line Feed characters are considered printable. With one exception, all messages from Controller-to-Target require a response – this will be either to return data that has been requested by the Controller, or to acknowledge reception of an instruction to change the configuration of the Target.

Controller-to-Target						
Start of Packet	Target Address	Address Delimiter	Instruction Code	Code Qualifier	Optional Arguments	End of Packet
< ASCII code 60 (1 character)	(4 characters)	/ ASCII code 47 (1 character)	(3 characters)	= or ? ASCII codes 61 or 63 (1 character)	(n characters)	Carriage Return ASCII code 13 (1 character)

**Example:** <0135/TFQ=70.2345{CR}

Target-to-Controller						
Start of Packet	Target Address	Address Delimiter	Instruction Code	Code Qualifier	Optional Arguments	End of Packet
> ASCII code 62 (1 character)	(4 characters)	/ ASCII code 47 (1 character)	(3 characters)	=, ?, !, or * ASCII codes 61, 63, 33, or 42 (1 character)	(From 0 to n characters)	Carriage Return, Line Feed ASCII codes 13,10 (2 characters)

**Example:** >0654/RSW=32{CR}{LF}





### 10.2.1.1 SELECT: (Main) Menu

**SELECT:** Config Test Info  
Monitor Save/Ld Util **ODU**

The table that follows identifies the commands comprising the CDM-570A main menu, and the content section in this manual where explicit information may be referenced, either in this chapter or in **Chapter 6. FRONT PANEL OPERATION**:

Menu Branch	Chapter Sect.	Description
Config	6.3.2	Use this menu branch to fully configure the modem.
Monitor	6.3.3	Use this menu branch to monitor the alarm status of the modem, to view the log of stored events, and to display the Receive Parameters screen.
Test	6.3.4	Use this menu branch to invoke one of several test modes (loopbacks, for example).
Info	6.3.5	(Information) Use this menu branch to view information on the modem, without having to go into configuration screens.
Save/Ld	6.3.6	Use this menu branch to save (store) and to load (retrieve) up to 10 different modem configurations.
Util	6.3.7	(Utility) Use this menu branch to perform miscellaneous functions, such as setting the real-time clock, adjusting the display brightness, etc.
ODU	10.2.1.2 10.2.1.2.1 (CSAT) 10.2.1.2.2 (KST)	<b>(Outdoor Unit)</b> Use this <b>CDM-570A</b> menu branch to monitor and control a Comtech EF Data RF Transceiver (CSAT-5060 or KST-2000A/B), if connected.

For ODU operation, use the ◀ ▶ arrow keys to select **ODU**, and then press **ENTER**.

### 10.2.1.2 (SELECT:) ODU

**Transceiver Control:**  
Disable Enable (◀ ▶,ENT)

Use the ◀ ▶ arrow keys to select **Disable** or **Enable**, and then press **ENTER**. Note the following:

<b>Disable</b>	This menu item turns <b>OFF</b> the FSK link to the ODU
<b>Enable</b>	This menu item turns <b>ON</b> the FSK link to the ODU.  The message “ <b>ATTEMPTING COMMUNICATION WITH ODU... PLEASE WAIT</b> ” displays while the the CDM-570A senses and connects with the active ODU model. If no ODU is present, the process aborts and the modem returns to the <b>SELECT: ODU</b> menu screen.  Otherwise, once a CSAT-5060 or KST2000A/B Transceiver successfully connects with the modem via the FSK link, sections <b>10.2.1.2.1</b> and <b>10.2.1.2.2</b> in this chapter address the pertinent front panel operation functionality. See <b>Figure 10-3</b> and <b>Figure 10-4</b> for the ODU-specific CDM-570A menu tree diagrams.

### 10.2.1.2.1 (SELECT:) ODU – CSAT-5060 Transceiver Operation

Figure 10-3 identifies the CDM-570A front panel menu hierarchy as it specifically addresses CSAT-5060 ODU operation.

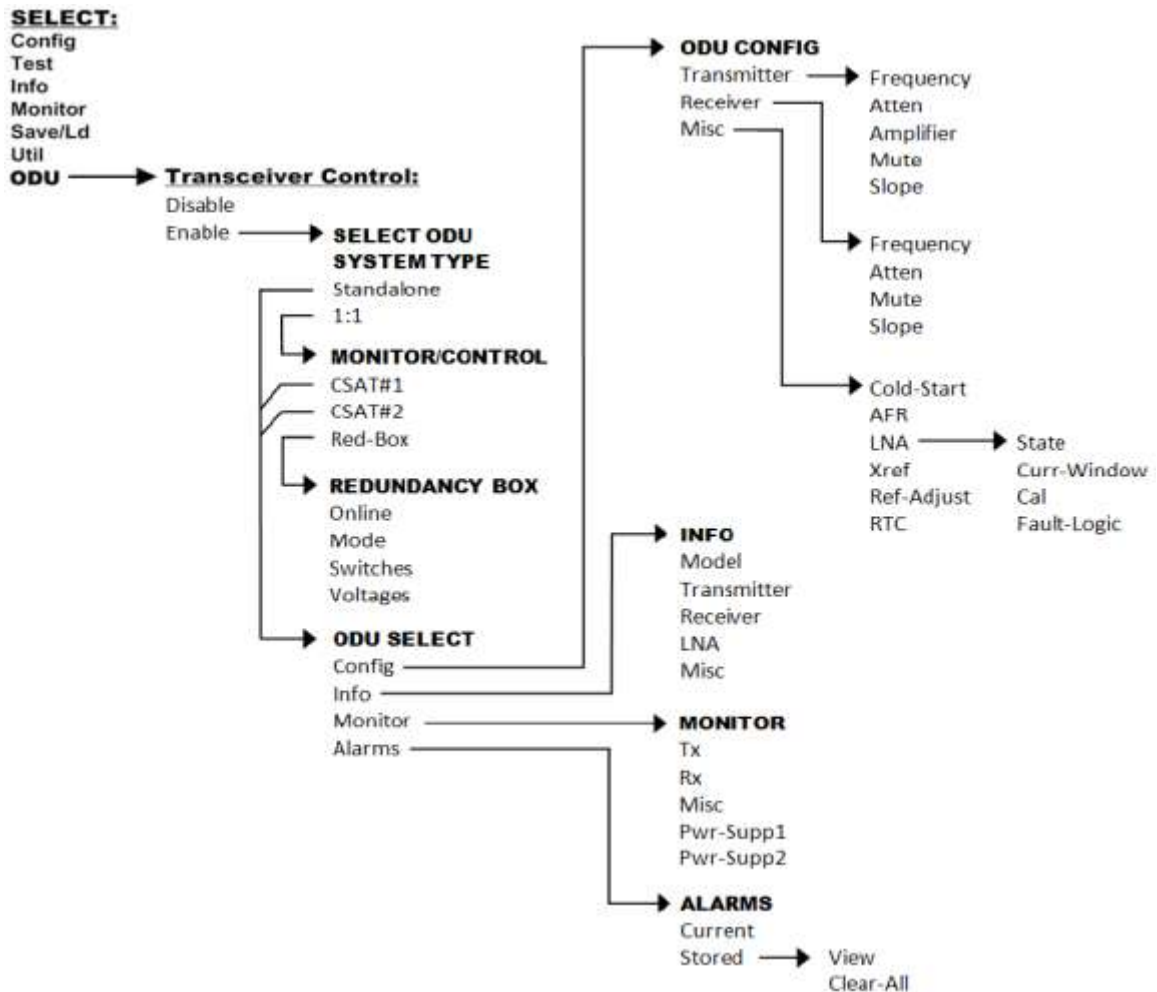



Figure 10-3. ODU: CSAT-5060 Transceiver Menu Tree

#### 10.2.1.2.1.1 (ODU: Transceiver Control) Enable

```
Select ODU System Type:
Standalone 1:1 (◀ ▶, ENT)
```

Use the ◀ ▶ arrow keys to select **Standalone** or **1:1**, and then press **ENTER**. Note the following:

- Select **Standalone** when the modem is linked via the Rx IF cable to a single Comtech EF Data CSAT-5060 ODU.
- Select **1:1** when the modem is linked to a redundant CSAT-5060 system via connection between the Rx IF and the ODU Redundancy Controller Box.



**When you make any of the following menu selections:**

- (ODU Transceiver Control) Enable ► Standalone
- (ODU Transceiver Control) Enable ► 1:1 ► CSAT#1
- (ODU Transceiver Control) Enable ► 1:1 ► CSAT#2

The modem directs you to a common ODU SELECT submenu:

```
ODU SELECT: Config  Info
Monitor Alarms (< ►,ENT)
```

See Sect. 10.2.1.2.1.1.1 for details about this common submenu.

### (ODU: Transceiver Control) Enable ► Standalone

```
ODU SELECT: Config  Info
Monitor Alarms (< ►,ENT)
```

Use the ◀ ▶ arrow keys to select **Config**, **Info**, **Monitor**, or **Alarms**, and then press **ENTER**. The selections for this common submenu branch are defined in detail in **Sect. .**

### (ODU: Transceiver Control) Enable ► 1:1

```
Monitor/Control: CSAT#1
CSAT#2 Red-Box (< ►,ENT)
```

For monitor/control of a redundant CSAT-5060 system: Use the ◀ ▶ arrow keys to select **CSAT#1**, **CSAT#2**, or **Red-Box**, and then press **ENTER**.

### (ODU: Transceiver Control) Enable ► 1:1 ► CSAT#1 or CSAT#2

```
ODU SELECT: Config  Info
Monitor Alarms (< ►,ENT)
```

Use the ◀ ▶ arrow keys to select **Config**, **Info**, **Monitor**, or **Alarms**, and then press **ENTER**. The selections for this common submenu branch are defined in detail in **Sect. K.3.3.1.1.1.1.**

### (ODU: Transceiver Control) Enable ► 1:1 ► Red-Box

```
Redundancy Box: Online
Mode Switches Voltages
```

Use the ◀ ▶ arrow keys to select **Online**, **Mode**, **Switches**, or **Voltages**, and then press **ENTER**.

### (ODU: Transceiver Control) Enable ► 1:1 ► Redundancy Box ► Online

```
Online Unit:
CSAT#1 CSAT#2 (< ►,ENT)
```

This display indicates the ODU **currently online**. The cursor will be flashing under **CSAT#1** or **CSAT#2**. If the need arises to change the **Online** unit, use the ◀ ▶ arrow keys to move the cursor position to the desired unit, and then press **ENTER**.



If the ODU Redundancy system is in **AUTO** mode, a ‘forced switch-over’ can only occur if the currently Offline unit is fault-free.

### (ODU: Transceiver Control) Enable ▶ 1:1 ▶ Redundancy Box ▶ Mode

```
Operating Mode:  
Manual Auto (◀ ▶,ENT)
```

This screen indicates the **current operating mode** of the 1:1 ODU system. The cursor will be flashing under **Manual** or **Auto**. If the need arises to change the operating mode of the 1:1 system, use the ◀ ▶ arrow keys to move the cursor position to the desired operating mode, and then press **ENTER**.

### (ODU: Transceiver Control) Enable ▶ 1:1 ▶ Redundancy Box ▶ Switches

```
Waveguide Switch Status:  
Tx=OK Rx=OK (ENT or CLR)
```

This read-only screen shows status for both the Tx and Rx Waveguide Transfer Switches. If either Switch reports an ambiguity from the commanded position, “OK” will change to “**FT**” to indicate a switch fault.

### (ODU: Transceiver Control) Enable ▶ 1:1 ▶ Redundancy Box ▶ Voltages

```
Redundancy Box Voltages:  
5V= 5.0 12V=12.0 (ENT)
```

This read-only screen allows you to troubleshoot system problems. It monitors and displays the voltages inside the Redundancy Controller Box.

### 10.2.1.2.1.1.1 COMMON 'ODU SELECT' SUBMENU

(ODU: Transceiver Control) Enable ▶ Standalone ▶

(ODU: Transceiver Control) Enable ▶ 1:1 ▶ CSAT#1 ▶

(ODU: Transceiver Control) Enable ▶ 1:1 ▶ CSAT#2 ▶

```
ODU SELECT: Config  Info
Monitor Alarms (< ▶,ENT)
```

Use the ◀ ▶ arrow keys to select **Config**, **Info**, **Monitor**, or **Alarms**, and then press **ENTER**.

#### 10.2.1.2.1.1.1.1 (ODU SELECT:) Config

```
ODU CONFIG: Transmitter
Receiver Misc (< ▶,ENT)
```

Use the ◀ ▶ arrow keys to select **Transmitter**, **Receiver**, or **Misc**, and then press **ENTER**.

#### (ODU CONFIG:) Transmitter

```
ODU TX: Frequency Atten
Amplifier Mute Slope < ▶
```

Use the ◀ ▶ arrow keys to select **Frequency**, **Atten**, **Amplifier**, **Mute**, or **Slope**, and then press **ENTER**.

#### (ODU CONFIG ▶ ODU TX:) Frequency

```
ODU Tx Frequency:
5912.5 MHz (< ▶,▲ ▼,ENT)
```

To edit the transmit frequency: First, use the ◀ ▶ arrow keys to select a digit, and then use the ▲ ▼ arrow keys to change the value of that digit. Press **ENTER** when done.

#### (ODU CONFIG ▶ ODU TX:) Atten (Attenuation)

```
ODU Tx Attenuation:
15.00 dB (< ▶,▲ ▼,ENT)
```

To edit the transmit attenuation: First, use the ◀ ▶ arrow keys to select a digit, and then use the ▲ ▼ arrow keys to change the value of that digit. Press **ENTER** when done.

#### (ODU CONFIG ▶ ODU TX:) Amplifier

```
ODU Tx Amp State:
On Off (< ▶,ENT)
```

Use the ◀ ▶ arrow keys to select **On** or **Off**, and then press **ENTER**.

### (ODU CONFIG ► ODU TX:) Mute

```
ODU Tx Mute State:  
Muted Unmuted (◀ ▶,ENT)
```

Use the ◀ ▶ arrow keys to select **Muted** or **Unmuted**, and then press **ENTER**.

### (ODU CONFIG ► ODU TX:) Slope

```
ODU Tx Slope Mode:  
Manual Calibrated (◀ ▶)
```

Use the ◀ ▶ the arrow keys to select **Manual** or **Calibrated**, and then press **ENTER**.

### (ODU CONFIG ► ODU TX:) Slope ► Manual

```
ODU Tx Slope:  
0.0 (▲ ▼, ENT)
```

Use the ▲ ▼ arrow keys to edit the transmit slope setting, and then press **ENTER**.

### (ODU CONFIG ► ODU TX:) Slope ► Calibrated

```
Calibrate TX Slope?  
Cal Exit (◀ ▶,ENT)
```

Use the ◀ ▶ arrow keys to select **Cal** or **Exit**, and then press **ENTER**.

## (ODU CONFIG:) Receiver

```
ODU RX: Frequency Atten  
Mute Slope (◀ ▶,ENT)
```

Use the ◀ ▶ the arrow keys to select **Frequency**, **Atten**, **Mute**, or **Slope**, and then press **ENTER**.

### (ODU CONFIG ► ODU RX:) Frequency

```
ODU Rx Frequency:  
5912.5 MHz (◀ ▶,▲ ▼,ENT)
```

To edit the receiver frequency: First, use the ◀ ▶ arrow keys to select a digit, and then use the ▲ ▼ arrow keys to change the value of that digit. Press **ENTER** when done.

### (ODU CONFIG ► ODU RX:) Atten (Attenuation)

```
ODU Rx Attenuation:  
15.00 dB (◀ ▶,▲ ▼,ENT)
```

To edit the receiver attenuation: First, use the ◀ ▶ arrow keys to select a digit, and then use the ▲ ▼ arrow keys to change the value of that digit. Press **ENTER** when done.

**(ODU CONFIG ► ODU RX:) Mute**

```
ODU Rx Mute State:  
Muted Unmuted (< ►, ENT)
```

Use the ◀ ▶ arrow keys to select **Muted** or **Unmuted**, and then press **ENTER**.

**(ODU CONFIG ► ODU RX:) Slope**

```
ODU Rx Slope Mode:  
Manual Calibrated (< ►)
```

Use the ◀ ▶ arrow keys select **Manual** or **Calibrated**, and then press **ENTER**.

**(ODU CONFIG ► ODU RX:) Slope ► Manual**

```
ODU Rx Slope:  
0.0 (▲ ▼, ENT)
```

Use the ▲ ▼ arrow keys to edit the ODU Rx Slope setting, and then press **ENTER**.

**(ODU CONFIG ► ODU RX:) Slope ► Calibrated**

```
Calibrate RX Slope?  
Cal Exit (< ►, ENT)
```

Use the ◀ ▶ arrow keys to select **Cal** or **Exit**, and then press **ENTER**.

**(ODU CONFIG): Misc**

```
MISC: Cold-Start AFR LNA  
XRef Ref-Adjust RTC (< ►)
```

Use the ◀ ▶ arrow keys to select **Cold-Start**, **AFR**, **LNA**, **XRef**, **Ref-Adjust**, or **RTC**, and then press **ENTER**.

**(ODU CONFIG ► MISC:) Cold-Start**

```
Cold-Start State:  
Enabled Disabled (< ►)
```

Use the ◀ ▶ arrow keys to select **Enabled** or **Disabled**, and then press **ENTER**.

**(ODU CONFIG ► MISC:) AFR (Auto Fault Recovery)**

```
Auto Fault Recovery:  
Enabled Disabled (< ►)
```

Use the ◀ ▶ arrow keys to select **Enabled** or **Disabled**, and then press **ENTER**.



## (ODU CONFIG ► MISC:) LNA

```
LNA: State Curr-Window  
Cal Fault-Logic (◀ ▶,ENT)
```

Use the ◀ ▶ arrow keys to select **State**, **Curr-Window**, **Cal**, or **Fault-Logic**, and then press **ENTER**.

### (ODU CONFIG ► MISC:) LNA ► State

```
ODU LNA State:  
On Off (◀ ▶,ENT)
```

Use this menu to control whether or not the CSAT provides LNA POWER via the Receive RF Cable. Use the ◀ ▶ arrow keys to select **On** or **Off**, and then press **ENTER**.

### (ODU CONFIG ► MISC:) LNA ► Curr-Window

```
LNA Current Window:  
99 % (▲ ▼,ENT)
```

Use this menu to define the allowable LNA current change before declaring a fault. Edit the LNA Current Window setting as follows:

- Use the ▲ ▼ arrow keys to select a value – the value scrolls from **20%** to **50%**.
- Select **99%** to disable the LNA Current Window function.
- Press **ENTER** when done.

### (ODU CONFIG ► MISC:) LNA ► Cal (Calibrate)

```
Calibrate LNA Current?  
Cal Exit (◀ ▶,ENT)
```

Use this menu to calibrate the LNA current for use with the LNA Current-Window function (described previously). Use the ◀ ▶ arrow keys to select **Cal** or **Exit**, and then press **ENTER**.

### (ODU CONFIG ► MISC:) LNA ► Fault-Logic

```
LNA: State Curr-Window  
Cal Fault-Logic (◀ ▶,ENT)
```

Use the ◀ ▶ arrow keys to select **State**, **Curr-Window**, **Cal**, or **Fault-Logic**, and then press **ENTER**.

## (ODU CONFIG ► MISC:) XRef (External Reference)

```
ExternalRef Fault Logic:
Summary No-Summary (< ►)
```

Use the ◀ ▶ arrow keys to select **Summary** or **No-Summary**, and then press **ENTER**.



The CSAT automatically locks to an external 5 or 10 MHz reference independent of the state of this selection. This selection determines whether or not the Summary Fault Relay is activated if the CSAT loses lock with the external reference.

## (ODU CONFIG ► MISC:) Ref-Adjust

```
Internal Ref Adjustment:
087 (▲ ▼, ENT)
```

Use the ▲ ▼ arrow keys to select an Internal 10MHz Reference setting value from **000** to **255**. Press **ENTER** when done.



The Internal Reference is adjusted in the factory to be very accurate with the default setting of 087. Use this feature as needed to compensate for the long-term frequency drift of the oscillator.

## (ODU CONFIG ► MISC:) RTC (Real-Time Clock)

```
Sync ODU RTC to Lcl RTC:
Yes No (< ►, ENT)
```

Use the ◀ ▶ arrow keys to select **Yes** to cause the CSAT RTC (Real Time Clock) to synchronize with the modem RTC, or **No**. Press **ENTER** when done.

### 10.2.1.2.1.1.1.2 (ODU SELECT:) Info (Information)

```
INFO: Model Transmitter
Receiver LNA Misc (< ►)
```

For read-only information on the ODU as currently configured for operation, use the ◀ ▶ arrow keys to select **Model**, **Transmitter**, **Receiver**, **LNA**, or **Misc**. Press **ENTER** when done.



The read-only screen shots that follow depict sample configurations – the actual values and settings will vary and they are dependent on the ODU configuration in use. Typical for all nested screens, press **ENTER** or **CLEAR** to return to the ODU SELECT: Info menu.

#### (ODU SELECT ► INFO): Model

```
CSAT-5060/010 V2.09
SERIAL # 00225 (ENT)
```

This screen shows the model and serial number for the ODU in use.

### (ODU SELECT ► INFO): Transmitter

```
Tx: ON 5845.0MHz 10.00dB
AMP:ON Unmuted S1:0.0
```

This screen shows information on the CSAT transmitter status: Tx operating state (**ON** or **OFF**); Tx Frequency; Tx Attenuation; Amplifier state (**ON** or **OFF**); Tx Mute state (**Muted** or **Unmuted**); and Tx Slope adjustment.

### (ODU SELECT ► INFO): Receiver

```
Rx: ON 3570.0MHz 10.00dB
Unmuted S1:0.0
```

This screen shows information on the CSAT receiver status: Rx operating state (**ON** or **OFF**); Rx Frequency; Rx Attenuation; Rx Mute state (**Muted** or **Unmuted**); and Rx Slope adjustment.

### (ODU SELECT ► INFO): LNA

```
LNA: On Window: 99%
Fault Logic: No-Summary
```

This screen shows the current state of the LNA functions: the LNA operating status (**ON** or **OFF**); the Current Window; and Fault-Logic settings (**Summary** or **No-Summary**).

### (ODU SELECT ► INFO): Misc

```
Cold Start: Off
Auto Fault Recovery: On
```

This screen shows the current state of the Cold Start and Auto Fault Recovery functions as **ON** or **OFF**.

## 10.2.1.2.1.1.1.3 (ODU SELECT:) Monitor

```
ODU MONITOR: Tx Rx Misc
Pwr-Supp1 Pwr-Supp2 (◀ ▶)
```

For access to real-time information displays on the ODU currently in operation, use the ◀ ▶ arrow keys to select **Tx**, **Rx**, **Misc**, **Pwr-Supp1**, or **Pwr-Supp2**. Press **ENTER** when done.



The read-only screen shots that follow depict sample configurations – the actual values and settings will vary and they are dependent on the ODU configuration in use. Typical for all nested screens, press **ENTER** or **CLEAR** to return to the ODU SELECT: Monitor menu.

### (ODU SELECT ► ODU MONITOR:) Tx

```
TX: SynTune=04.8 Pwr=040
IFLO = 10.7 Temp = 27 oC
```

This screen shows the Tx Synthesizer and IFLO tuning voltages, the RF Output Power in dBm and the Transmitter temperature.

**(ODU SELECT ► ODU MONITOR:) Rx**

```
RX: Synth Tune = 03.1  
IFLO = 10.9 Temp = 28 oC
```

This screen shows the Rx Synthesizer and IFLO tuning voltages and the Receiver temperature.

**(ODU SELECT ► ODU MONITOR:) Misc**

```
MISC: Ref Tune = 03.0  
LNA=000.0mA FAN=568.0mA
```

This screen shows the Internal Reference Oscillator tuning voltages, the LNA Current in milliamps and the Fan Current in milliamps.

**(ODU SELECT ► ODU MONITOR:) Pwr-Supp1**

```
PS: 24V=23.8 20V=22.6  
12V=13.0 10V=10.1
```

This screen monitors the first four of the six internal power supplies.

**(ODU SELECT ► ODU MONITOR:) Pwr-Supp2**

```
PS: +5V=5.5 -5V=-4.9
```

This screen monitors the remaining two internal power supplies.

**10.2.1.2.1.1.1.4 (ODU SELECT:) Alarms**

```
ALARMS: Current Stored  
(◀ ►, ENT)
```

Use the ◀ ► arrow keys to select **Current** or **Stored**, and then press **ENTER**.

**(ODU SELECT ► ALARMS:) Current**

```
TX = OK RX = OK  
PWR SUP = OK MISC = OK
```

This screen summarizes the CSAT's current operational status. If any item displays "**FT**" instead of "**OK**" then that feature is faulted. View the **Stored Events Log** for further details.

**(ODU SELECT ► ALARMS:) Stored**

```
Stored Events: View  
Clear All (◀ ►, ENT)
```

Use the ◀ ► arrow keys to select **View** or **Clear All**, and then press **ENTER**.

**(ODU SELECT ► ALARMS:) Stored ► View**

```
LOG 02:11/13/99 10:42:47
OK- REF LOCK (▲ ▼)
```

Per the example shown, use the ▲▼ arrow keys to sequentially view the individual entries in the **Stored Events Log**. Otherwise, press **CLEAR** to return to the previous menu.

**(ODU SELECT ► ALARMS:) Stored ► Clear All**

```
PRESS ENT TO
CLEAR THE EVENTS LOG
```

Press **ENTER** to clear the **Stored Events Log**. Otherwise, press **CLEAR** to return to the previous menu.

**10.2.1.2.2 (SELECT:) ODU – KST-2000A/B Transceiver Operation**

**Figure 10-4** identifies the CDM-570A front panel menu hierarchy as it pertains specifically to operation of the KST-2000A (LNA) or KST-2000B (LNB) ODU.

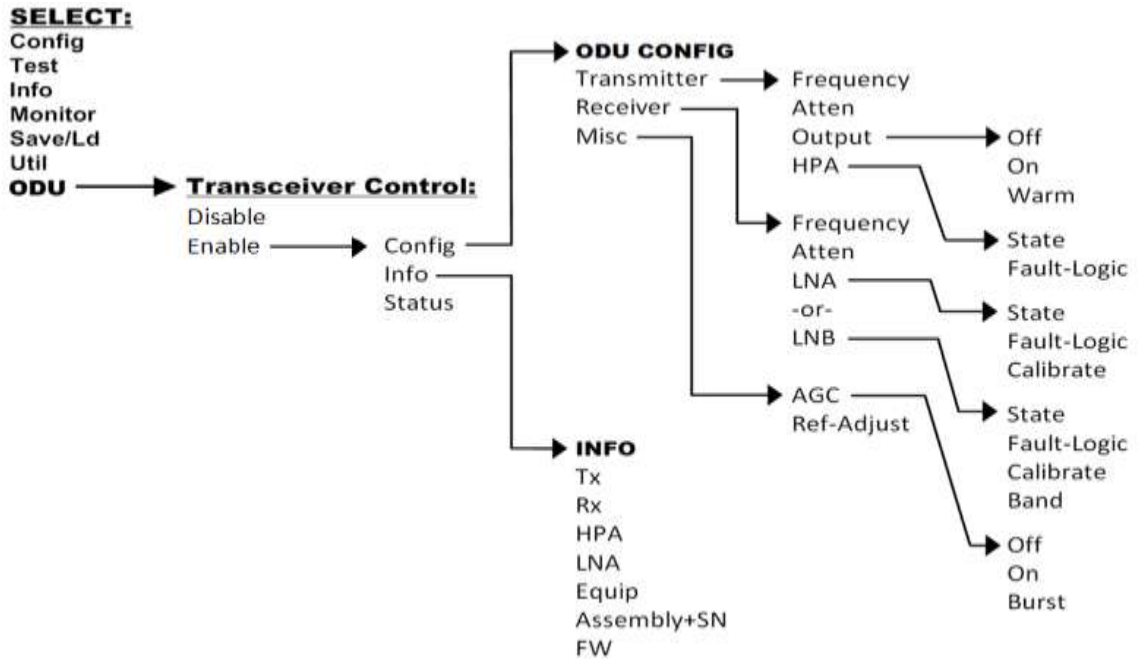

**Figure 10-4. ODU: KST-2000A/B Transceiver Menu Tree**

### 10.2.1.2.2.1 (ODU: Transceiver Control) Enable

```
KST SELECT: Config  Info
Status          (< >, ENT)
```

Use the ◀ ▶ arrow keys to select **Config**, **Info**, or **Status**, and then press **ENTER**.

#### 10.2.1.2.2.1.1 (KST SELECT:) Config (KST Configuration)

```
KST CONFIG: Transmitter
Receiver Misc (< >, ENT)
```

Use the ◀ ▶ arrow keys to select **Transmitter**, **Receiver**, or **Misc**, and then press **ENTER**.

##### 10.2.1.2.2.1.1.1 (KST SELECT: ▶ KST CONFIG:) Transmitter

```
KST TX: Frequency  Atten
Output  HPA        (< >, ENT)
```

Use the ◀ ▶ arrow keys to select **Frequency**, **Atten**, **Output**, or **HPA**, and then press **ENTER**.

##### (KST CONFIG: ▶ KST TX:) Frequency

```
ODU Tx Frequency:
14500.0 MHz (< >, ▲ ▼, ENT)
```

To edit the transmit frequency, first use the ◀ ▶ arrow keys to select a digit, and then use the ▲ ▼ arrow keys to change the value of that digit. The frequency limits of the **KST-2000A** are known and the frequency values are constrained accordingly. Press **ENTER** when done.

##### (KST CONFIG: ▶ KST TX:) Atten (Attenuation)

```
ODU Tx Attenuation:
15 dB          (< >, ▲ ▼, ENT)
```

To edit the transmit attenuation, first use the ◀ ▶ arrow keys to select a digit, and then use the ▲ ▼ arrow keys to change the value of that digit. Press **ENTER** when done.

##### (KST CONFIG: ▶ KST TX:) Output

```
KST Tx Output:
Off  On  Warm (< >, ENT)
```

Use the ◀ ▶ arrow keys to select **OFF**, **ON**, or **WARM**, and then press **ENTER**. Note the following:

- WARM is OFF, if COLD.
- WARM is ON, if warm and NO FAULTS.
- If FAULTS are present, stays WARM and OFF indefinitely.

### (KST CONFIG: ► KST TX:) HPA

```
HPA: State Fault-Logic
      (< ►, ENT)
```

Use the ◀ ▶ arrow keys to select **State** or **Fault-Logic**, and then press **ENTER**.

### (KST CONFIG: ► KST TX:) HPA ► State

```
KST HPA State:
On Off      (< ►, ENT)
```

Use the ◀ ▶ arrow keys to select **On** or **Off**, and then press **ENTER**.



If the HPA power is **Off**, it cannot report errors, answer messages, provide serial numbers, etc.

### (KST CONFIG: ► KST TX:) HPA ► Fault-Logic

```
HPA Fault Logic: Summary
No-Summary      (< ►, ENT)
```

To control whether or not HPA fault will activate the SUMMARY FAULT RELAY, use the ◀ ▶ arrow keys to select **Summary** or **No-Summary**. Press **ENTER** when done.

## 10.2.1.2.2.1.1.2 (KST SELECT: ► KST CONFIG:) Receiver

```
KST RX: Frequency Atten
LNA      (< ►, ENT)
```

*(Displayed when ODU is a KST-2000A unit)*

```
KST RX: Frequency Atten
LNB      (< ►, ENT)
```

*(Displayed when ODU is a KST-2000B unit)*

Use the ◀ ▶ arrow keys to select **Frequency**, **Atten**, or **LNA/LNB**, and then press **ENTER**.

### (KST CONFIG: ► KST RX:) Frequency

```
ODU Rx Frequency:
10950.0 MHz (< ►, ▲ ▼, ENT)
```

To edit the receive frequency, first use the ◀ ▶ arrow keys to select a digit, and then use the ▲ ▼ arrow keys to change the value of that digit. Press **ENTER** when done.

### (KST CONFIG: ► KST RX:) Atten (Attenuation)

```
ODU Rx Attenuation:
15 dB      (< ►, ▲ ▼, ENT)
```

To edit the receive attenuation, first use the ◀ ▶ arrow keys to select a digit, and then use the ▲ ▼ arrow keys to change the value of that digit. Press **ENTER** when done.

**(KST CONFIG: ► KST RX:) LNA**

```
LNA: State Fault-Logic
Calibrate      (< ►,ENT)
```

*(Displayed when ODU is a **KST-2000A** unit)*

Use the ◀ ▶ arrow keys to select **State**, **Fault-Logic**, or **Calibrate**, and then press **ENTER**.

**(KST CONFIG: ► KST RX:) LNA ► State**

```
ODU LNA State:
On Off          (< ►,ENT)
```

To control whether or not the ODU provides LNA POWER via the Receive RF Cable, use the ◀ ▶ arrow keys to select **ON** or **OFF**. Press **ENTER** when done.

**(KST CONFIG: ► KST RX:) LNA ► Fault-Logic**

```
LNA Fault Logic: Summary
No-Summary      (< ►,ENT)
```

To control whether or not an LNA fault will activate the SUMMARY FAULT RELAY, use the ◀ ▶ arrow keys to select **Summary** or **No-Summary**. Press **ENTER** when done.

**(KST CONFIG: ► KST RX:) LNA ► Calibrate**

```
Calibrate LNA Current?
Cal Exit       (< ►,ENT)
```

Calibration allows the system to determine nominal LNA power consumption. This need only be performed at initial installation.

Use the ◀ ▶ arrow keys to select **Cal** or **Exit**, and then press **ENTER**.

**(KST CONFIG: ► KST RX:) LNB**

```
LNB: State Fault-Logic
Calibrate Band (< ►,ENT)
```

*(Displayed when ODU is **KST-2000B** unit)*

Use the ◀ ▶ arrow keys to select **State**, **Fault-Logic**, **Calibrate**, or **Band**, and then press **ENTER**.

**(KST CONFIG: ► KST RX:) LNB ► State****(KST CONFIG: ► KST RX:) LNB ► Fault-Logic****(KST CONFIG: ► KST RX:) LNB ► Calibrate**

The **State**, **Fault-Logic**, and **Calibrate** commands operate identically to those used for the LNA (KST-2000A) unit.



Additionally:

### (KST CONFIG: ► KST RX:) LNB ► Band

```
LNB Rx Band:
A B C      (◀ ▶,ENT) (Displayed when ODU is KST-2000B unit)
```

Use the ◀ ▶ arrow keys to select **A**, **B**, or **C**, and then press **ENTER**.

## 10.2.1.2.2.1.1.3 (KST SELECT: ► KST CONFIG:) Misc (Miscellaneous)

```
KST MISC: AGC Ref-Adjust
          (◀ ▶,ENT)
```

Use the ◀ ▶ arrow keys to select **AGC** or **Ref-Adjust**, and then press **ENTER**.

### (KST CONFIG: ► KST MISC:) AGC

```
AGC MODE:
Off On Burst (◀ ▶,ENT)
```

Use the ◀ ▶ arrow keys to select **OFF**, **ON** or **BURST**, and then press **ENTER**.

### (KST CONFIG: ► KST MISC:) Ref-Adjust

```
Internal Ref Adjustment:
087      (▲ ▼,ENT)
```

To edit the INT 10MHz REF setting: Use the ▲ ▼ arrow keys to select a value – the values scroll from **000** to **255** – then press **ENTER**.



**The INT REF is adjusted in the factory to be very accurate with the default setting of 028. Use this feature as needed to compensate for the long-term frequency drift of the oscillator.**

## 10.2.1.2.2.1.2 (KST SELECT:) INFO (Information)

```
INFO:TX RX HPA LNA Equip
Assembly+SN FW (◀ ▶,ENT)
```

For access to real-time, read-only information displays on the ODU currently in operation: Use the ◀ ▶ arrow keys to select **TX**, **RX**, **HPA**, **LNA**, **Equip**, **Assembly+SN**, or **FW**, and then press **ENTER**.



The read-only screen shots that follow depict sample configurations – the actual values and settings will vary and they are dependent on the ODU configuration in use. Typical for all nested screens, press **ENTER** or **CLEAR** to return to the (ODU: Enable: ► **KST SELECT:**) **INFO** menu.

### **(KST SELECT: ► INFO:) TX (TRANSMITTER)**

```
TX: ON 14500.0MHz 19dB
AGC: OFF
```

This screen shows the **KST-2000A** transmitter status: Tx operating state (**ON** or **OFF**); Tx Frequency; Tx Attenuation; and AGC state (**ON** or **OFF**).

### **(KST SELECT: ► INFO:) RX (RECEIVER)**

```
RX: ON 10950.0MHz 15dB
Ref-Adjust: 228
```

This screen shows the **KST-2000A** receiver status: Rx operating state (**ON** or **OFF**); Rx Frequency; Rx Attenuation; and Internal Reference adjustment.

### **(KST SELECT: ► INFO:) HPA**

```
HPA: On
Fault Logic: No Summary
```

This screen shows the current HPA configuration: HPA (**ON** or **OFF**) and Fault Logic (**Summary** or **No Summary**).

### **(KST SELECT: ► INFO:) LNA**

```
LNA: On
Fault Logic: No Summary
```

This screen shows the current LNA configuration: LNA (**ON** or **OFF**) and Fault Logic (**Summary** or **No Summary**).

### **(KST SELECT: ► INFO:) Equip (Equipment)**

```
EQUIP-TYPE: KST-2000A
HPA-TYPE: CEFD-SSPA
```

This screen shows the currently installed ODUs: The transceiver, high-power amplifier, and solid-state power amplifier.

**(KST SELECT: ► INFO:) Assembly+SN**

ASSEMBLY INFO: M&C  
AS:11565-4 SN:001370891



The blinking cursor is on the M&C. Use the ▲▼ arrow keys to view additional assembly and S/N information for the Up Converter, Down Converter, and HPA.

**(KST SELECT: ► INFO:) FW (Firmware)**

FIRMWARE INFO: M&C  
FW:10303-1D VER:01.01.05



The blinking cursor is on the M&C. Use the ▲▼ arrow keys to view additional assembly and S/N information for the Up Converter, Down Converter, and HPA.

### 10.2.1.2.2.1.3 (KST SELECT:) Status

STATUS:PS:OK RF:OK UC:OK  
LNA:OK AG:OK HP:OK DC:OK

Use the ◀ ▶ arrow keys to select a feature, and then press **ENTER** to view more detailed status information. The nested screens provide continually-updated, read-only operational summary information, as follows:

Feature (Selection)	Designates	Detailed Status Display Example
PS	Power Supplies	P/Supplies: 7V:OK 17V:OK -7V:OK 12V:OK
RF	Reference	REF:WARM 72M:OK RANGE:NA SRC:INT XLK:NA PHASE:NA
UC	Up Converter	UPCONV STATUS: OVRTMP:OK SSYN:OK KSYN:OK PRG:OK
LNA	Low Noise Amplifier	A detailed status display screen is not available for this selection.
AG	AGC Status	AGC STATUS: EIP:OK LOOP:OK IIP:OK
HP	HPA Status	HPA: OVRTMP:OK 9.75V:OK -5V:OK BIAS:OK PRG:OK
DC	Down Converter	DNCONV STATUS: OVRTMP:OK LSYN:OK KSYN:OK PRG:OK

For each detailed status display, the available status indications are as follows:

Summary Status	Designates
OK	OK – No Fault
FT	Fault
NA	Not Applicable

Typical for all nested screens, press **ENTER** or **CLEAR** to return to the **ODU: Enable → Status** submenu.

## 10.2.2 Transceiver M&C via the CDM-570A's HTTP Interface



### Chapter 7. ETHERNET-BASED REMOTE PRODUCT MANAGEMENT

**Figure 10-5** shows the menu tree for ODU-accessible features when using the CDM-570A (70/140 MHz) Satellite Modem. Modem operations not specific to CDM-570A CSAT/KST Transceiver operation appear dimmed in this diagram and are explained in Chapter 7. This menu tree depicts the CDM-570A HTTP Interface as it appears with all FAST Features activated, and the optional IP Packet Processor **installed and active**.

See **Sect. 10.3.2** for ODU operations applicable to the CDM/R-570AL (L-Band) Satellite Modem and its use with Comtech EF Data BUCs and LNBs.

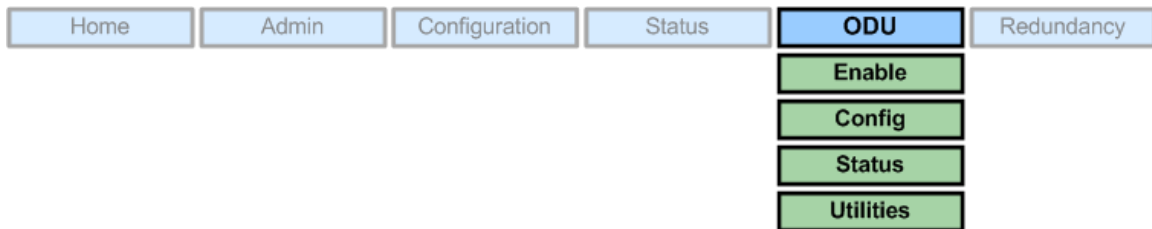

**Figure 10-5. CDM-570A HTTP Interface – ODU CSAT/KST Transceiver Menu Tree**

### 10.2.2.1 ODU Pages



**ODU Comms must be enabled using the 'ODU | Enable' page (see Sect. 10.2.2.1.1) in order to fully access the 'ODU | Config', 'ODU | Status', and 'ODU | Utilities' pages.**

M&C of the CSAT-5060 or KST-2000A/B ODU that is connected via FSK to the CDM-570A is possible using the pages nested under the **'ODU'** tab. These pages are accessible only when an ODU is configured for operation with the CDM-570A.

All three levels of user login permit viewing of all ODU pages. However, only a user with Administrative or Read/Write privileges can submit changes to the **'ODU | Config'** and **'ODU | Utilities'** pages.

If you attempt to access the ODU pages without properly establishing communications parameters on the CDM-570A end, the HTTP Interface displays this error page:

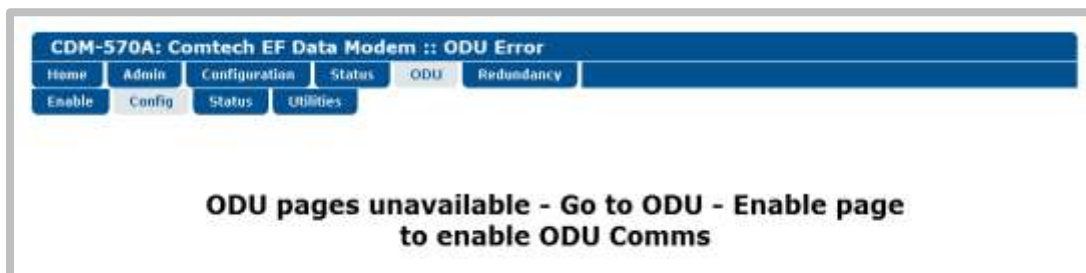

As this page indicates, you must first enable ODU Comms via the '**ODU | Enable**' page. For situations where other communications issues arise, e.g., a problem exists with communication between the installed ODU and the CDM-570A, the HTTP Interface displays this error page:



Refer to the pertinent ODU Installation and Operation Manual to troubleshoot the issue, or contact Comtech EF Data Product Support for further assistance.

### 10.2.2.1.1 ODU | Enable



Figure 10-6. ODU | Config Page (CSAT-5060)

### ODU Comms

Use the drop-down list to select ODU communications as **Disabled** or **Enabled**, and then click **[Submit]**.

Once ODU Comms have been properly enabled, from anywhere in the interview you may click the '**ODU**' tab, and then click the **Config**, **Status**, or **Utilities** tab to continue.

## 10.2.2.1.2 ODU | Config Pages



The appearance of the 'ODU | Config' page changes depending on which type of ODU has been recognized via FSK link for operation with the CDM-570A. Use this page to configure various ODU operating parameters.

### 10.2.2.1.2.1 ODU | Config (CSAT-5060)

Figure 10-7 shows the 'ODU | Config' page as it appears with the CSAT-5060 configured as the ODU. Use this page to configure the primary CSAT-5060 Transmit and Receive Parameters.



**CDM-570A: Comtech EF Data Modem :: CSAT-5060 Configuration**

Home Admin Configuration Status ODU Redundancy

Enable Config Status Utilities

ODU Selection  
CSAT#1  CSAT-5060/010 2.35 C042149170 SINGLE

ODU Configuration

**Up Converter Parameters**

Frequency: 8425.0 MHz (5845 - 6725)  
 Attenuation: 01.00 dB (0 - 25)  
 Slope Mode: Calibrated  
 Slope Adjust: 0.0 (Manual Mode Only)  
 Mute: Disabled  
 Gain Offset: -0.00 (1:1 Redundancy Only)  
 Amplifier: On

**Down Converter Parameters**

Frequency: 3625.0 MHz (3400 - 4200)  
 Attenuation: 10.00 dB (0 - 20)  
 Slope Mode: Manual  
 Slope Adjust: 0.0 (Manual Mode Only)  
 Mute: Disabled  
 Gain Offset: -0.00 (1:1 Redundancy Only)

**Unit Parameters**

Mute Mode: Muted after freq change  
 Auto Fault Recovery: Enabled  
 Cold Start: Disabled  
 Exit Reference Fault Logic: No Summary  
 Reference Oscillator Adjust: 340 (0-255)

**LNA Parameters**

Current Alarm Window: 21 (20-50, 99=disable)  
 Current Source: Enabled  
 Fault Logic: No Summary

**ODU Circuit Identification**

Circuit ID: 1

Figure 10-7. ODU | Config Page (CSAT-5060)

### ODU Selection

When using redundant ODUs, you may toggle the page between the Online and Offline units by selecting **CSAT #1** or **CSAT #2**, and then clicking **Select ODU**. A message identifies the active unit as '**ONLINE**' in the right-hand side of the box.

## Upconverter Parameters

- **Frequency** – Enter a value in MHz.
- **Attenuation** – Enter a value in dB.
- **Slope Mode** – Select **Manual** or **Calibrated** from the drop-down list.
- **Slope Adjust (Manual Mode Only)** – Select the desired setting from the drop-down list.
- **Mute** – Select **Enabled** or **Disabled** from the drop-down list.
- **Gain Offset (1:1 Redundancy Only)** – Select the desired setting from the drop-down list.
- **Amplifier** – Select **On** or **Off** from the drop-down list.

## Downconverter Parameters

- **Frequency** – Enter a value in MHz.
- **Attenuation** – Enter a value in dB.
- **Slope Mode** – Select **Manual** or **Calibrated** from the drop-down list.
- **Slope Adjust (Manual Mode Only)** – Select the desired setting from the drop-down list.
- **Mute** – Select **Enabled** or **Disabled** from the drop-down list.
- **Gain Offset (1:1 Redundancy Only)** – Select the desired setting from the drop-down list.

## Unit Parameters

- **Mute Mode** – Select **Muted** (after frequency change) or **Unmuted** (after frequency change) from the drop-down list.
- **Auto Fault Recovery** or **Cold Start** – Select **Enabled** or **Disabled** from the drop-down lists.
- **Ext Reference Fault Logic** – Select **Summary** or **No Summary** from the drop-down list.
- **Reference Oscillator Adjust** – Enter a value from **0** to **255**.

## LNA Parameters

- **Current Alarm Window** – Enter a value from **20** to **50**, or **99** to disable this feature.
- **Current Source** – Select **Enabled** or **Disabled** from the drop-down list.
- **Fault Logic** – Select **Summary** or **No Summary** from the drop-down list.



## ODU Circuit Identification

Enter an ODU Circuit Identification name of up to 24 alphanumeric characters.

Click **[Submit]** to save any changes made to this page.

### 10.2.2.1.2.2 ODU | Config (KST-2000A/B)

**Figure 10-8** shows the ‘ODU | Config’ page with the KST-2000A/B configured as the ODU. Use this page to configure the primary KST-2000A/B Transmit and Receive Parameters.

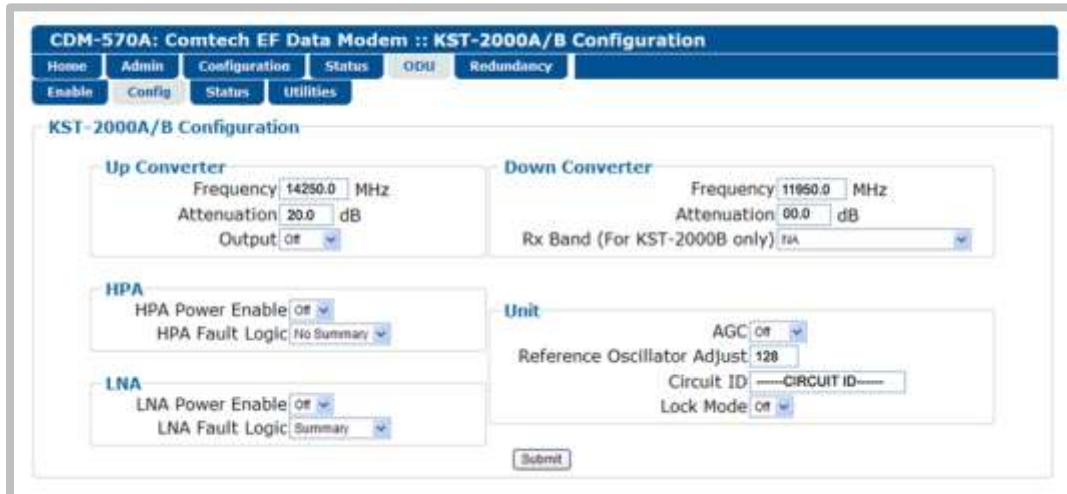

**Figure 10-8. ODU | Config Page (KST-2000A/B)**

### Upconverter Parameters

- **Frequency** – Enter a value in MHz.
- **Attenuation** – Enter a value in dB.
- **Output** – Select **On** or **Off** from the drop-down list.

### Downconverter Parameters

- **Frequency** – Enter a value in MHz.
- **Attenuation** – Enter a value in dB.
- **Rx Band (For KST-2000B Only):** Select **band A** (10950 to 11700 MHz), **band B** (11700 to 12200 MHz), or **band C** (12250 to 12750 MHz) from the drop-down list.

### HPA Parameters

- **HPA Power Enable** – Select **On** or **Off** from the drop-down list.
- **HPA Fault Logic** – Select **Summary** or **No Summary** from the drop-down list.

## LNA Parameters

- **LNA Power Enable** – Select **On** or **Off** from the drop-down list.
- **LNA Fault Logic** – Select **Summary** or **No Summary** from the drop-down list.

## Unit Parameters

- **AGC (Automatic Gain Control)** – Select **On** or **Off** from the drop-down list.
- **Reference Oscillator Adjust** – Enter a value from **0** to **255**.
- **Circuit ID** – Enter a Circuit Identification name of up to 24 alphanumeric characters.
- **Lock Mode** – Select **On** or **Off** from the drop-down list.

Click **[Submit]** to save any changes made to this page.

### 10.2.2.1.3 ODU | Status Pages



The appearance of the 'ODU | Status' page changes depending on which type of ODU has been recognized via FSK link for operation with the CDM-570A. These pages provide read-only status windows pertaining to the current operating condition for either the CSAT-5060 or the KST-2000A/B ODUs.

#### 10.2.2.1.3.1 ODU | Status (CSAT-5060)

Figure 10-9 shows the 'ODU | Status' page as it appears with the CSAT-5060 configured as the ODU. Use this page to review **read-only** status information pertaining to the CSAT-5060 **Maintenance Parameters**; **ODU Alarms**; and the number of **Unread Events** in the **Events Log**.

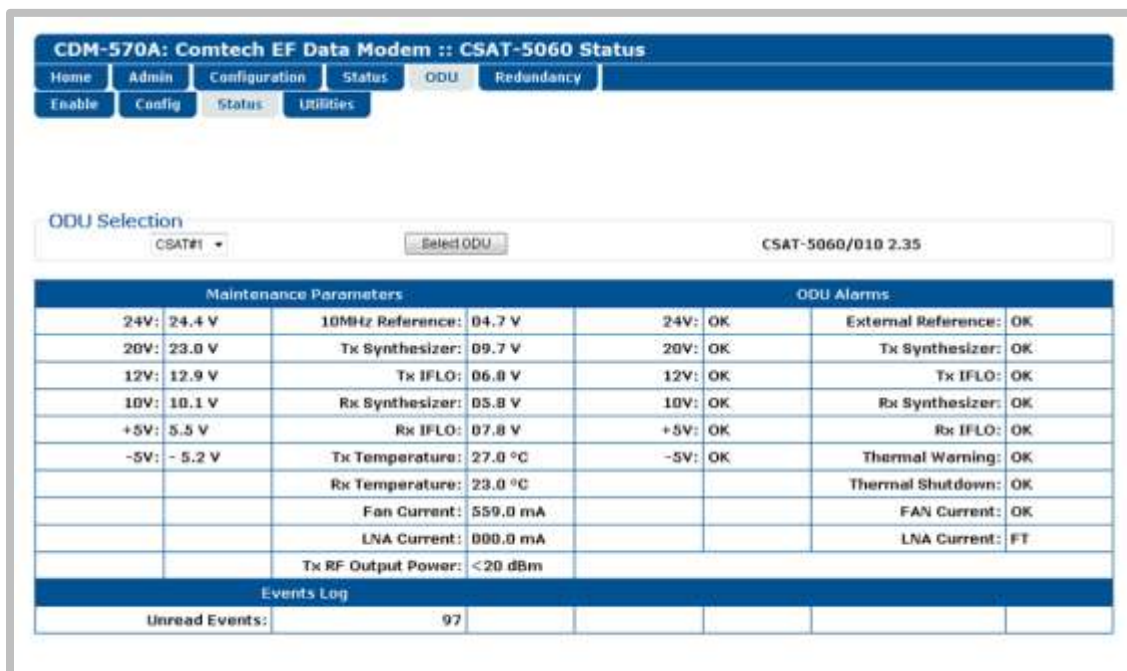

Figure 10-9. ODU | Status Page (CSAT-5060)

## ODU Selection

If redundant ODUs are used, the CSAT-5060 ‘ODU | Status’ page can toggle between the Online and Offline units. Use the drop-down list to select **CSAT #1** or **CSAT #2**, and then click **[Select ODU]**.

The page displays the current active unit in the right-hand side of the **ODU Selection** page section.

### 10.2.2.1.3.2 ODU | Status (KST-2000A/B)

**Figure 10-10** shows the ‘ODU | Status’ page as it appears with the KST-2000A/B configured as the ODU. The message bar at top identifies the **ODU Type** and **HPA Type** (in this example, KST-2000A and CEFD-SSPA, respectively).

Use this page to review **read-only** status information that summarizes the fault status of the KST-2000A/B configuration:

- Common Equipment
- Reference
- AGC
- HPA
- Up Converter
- Down Converter

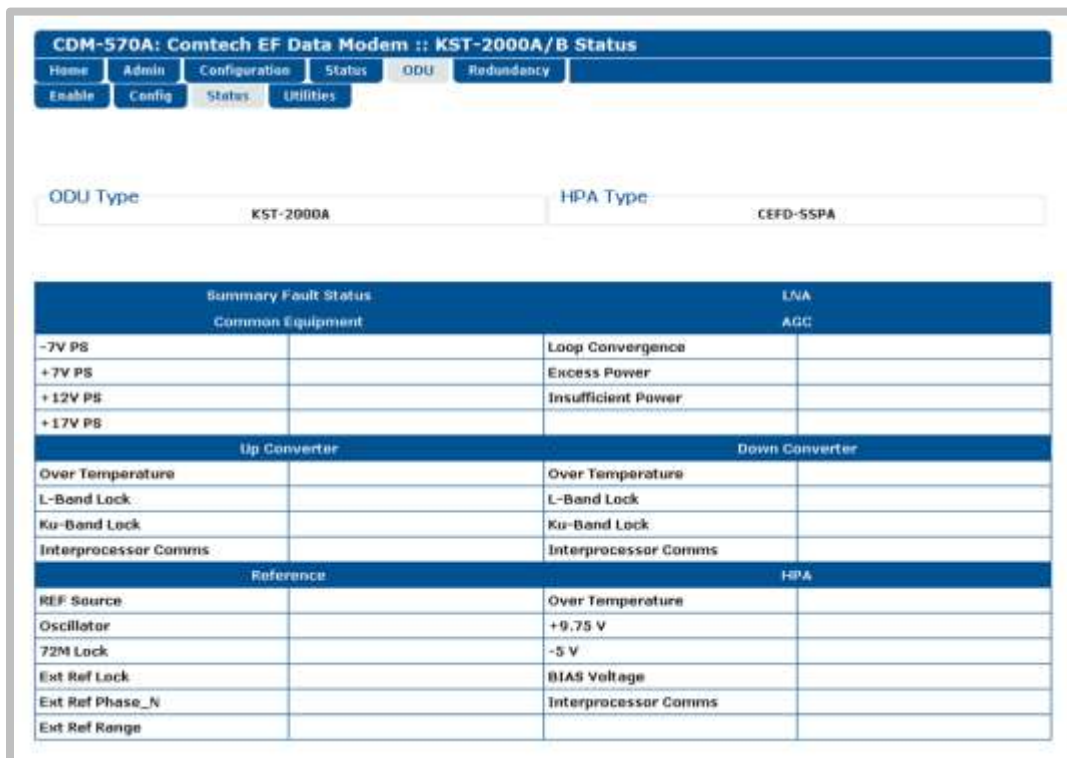

Common Equipment		LNA	
-7V PS		Loop Convergence	
+7V PS		Excess Power	
+12V PS		Insufficient Power	
+17V PS			
Up Converter		Down Converter	
Over Temperature		Over Temperature	
L-Band Lock		L-Band Lock	
Ku-Band Lock		Ku-Band Lock	
Interprocessor Comms		Interprocessor Comms	
Reference		HPA	
REF Source		Over Temperature	
Oscillator		+9.75 V	
72M Lock		-5 V	
Ext Ref Lock		BIAS Voltage	
Ext Ref Phase_N		Interprocessor Comms	
Ext Ref Range			

**Figure 10-10. ODU | Status Page (KST-2000A/B)**

## 10.2.2.1.4 ODU | Utilities Pages



The appearance of the ‘ODU | Utilities’ page changes depending on which type of ODU has been recognized via FSK link for operation with the CDM-570A. Use this page to configure various ODU utility functions.

### 10.2.2.1.4.1 ODU | Utilities (CSAT-5060)

Figure 10-11 shows the ‘ODU | Utilities’ page as it appears with the CSAT-5060 configured as the ODU.



Figure 10-11. ODU | Utilities Page (CSAT-5060)

### ODU Selection

If redundant ODUs are used, the CSAT-5060 ‘ODU | Status’ page can toggle between the Online and Offline units. Use the drop-down list to select **CSAT #1** or **CSAT #2**, and then click **[Select ODU]**.

The page displays the current active unit in the right-hand side of the **ODU Selection** page section.

### Force 1:1 Switch

If redundant ODUs are used and the selected unit is currently the ‘ONLINE’ unit, click **[Force 1:1 Switch]** to force the switchover of the ‘ONLINE’ unit into ‘STANDBY’ mode. **This command is only valid for the ‘ONLINE’ unit in a 1:1 pair.**

## Re-Calibrate LNA Current

Click to recalibrate the LNA Current.

## Redundancy Box Mode

Use the radio button to select **Automatic** or **Manual**, and then click **[Submit]** to execute.

## ODU Date and Time

- Use the international format HH:MM:SS to enter the time (where HH = hour [00 to 23], MM = minutes [00 to 59], and SS = seconds [00 to 59]).
- Use the European continental format DD/MM/YY to enter the date (where DD = day [01 to 31], MM = month [01 to 12], and YY = year [00 to 99]).

Click **[Enter Date/Time]** to save any changes made to this section.

## ODU Stored Events

This window provides a visual record of the ODU stored events in a scrollable window. Use the radio buttons as follows:

- **Read Next Five Events** – Click to buffer the next group of five stored events into the Events window.
- **Clear Stored Events** – Click to wipe clean the stored events log.
- **Initialize Events Pointer** – Click to reset the log's internal pointer.

Click **[Submit]** to save any changes made to this section.

- **Unread Events** – The scrolling Events window displays the total number of unread stored events. As stored entries are displayed, this number decrements accordingly.

### 10.2.2.1.4.2 ODU | Utilities (KST-2000A/B)

Figure 10-12 shows the ‘ODU | Utilities’ page, as it appears with the KST-2000A/B configured as the ODU. The message bar at top identifies the **ODU Type** and **HPA Type** (in this example, KST-2000A and CEFD-SSPA, respectively).

Use this page to review the **read-only** status information that identifies the configured ODU chassis’ installed component assembly numbers, serial numbers, firmware numbers, and firmware versions.



Figure 10-12. ODU | Utilities Page (KST-2000A/B)

## 10.2.3 Transceiver M&C via CDM-570A Serial Remote Control



### Chapter 8. SERIAL-BASED REMOTE PRODUCT MANAGEMENT

---

### 10.2.3.1 CDM-570A Transceiver Remote Control Address Setup



#### Appendix J. EDMAC CHANNEL

The ODU, as connected to a CDM-570A through FSK, can be remotely monitored and controlled through the use of ODU commands and queries issued via serial remote control. The address of the ODU is set up as follows:

- **For Local-End ODUs:**
  - Use the Modem's RC Address + 1 for the Standalone or Online Unit in a 1:1 Redundancy System;
  - Use the Modem's RC Address + 2 for the Offline Unit in a 1:1 Redundancy System.
- **For Distant-End ODUs in an EDMAC setup:**
  - Use the EDMAC Slave Address (ESA) Range +4 for Standalone Unit or the Online Unit in a 1:1 Redundancy System;
  - Use the EDMAC Slave Address (ESA) Range +5 for the Offline Unit in a 1:1 Redundancy System.

### 10.2.3.2 CDM-570A Transceiver Serial Remote Control Commands / Queries



#### Chapter 8. SERIAL-BASED REMOTE PRODUCT MANAGEMENT

The operands available through CDM-570A Serial-based Remote Product Management are identified in the following table – details on using these ODU-specific remote commands and queries are explicitly defined in **Chapter 8**.

Operand	Description
AUP	Command or Query – Use to configure EDMAC AUPC power level mode.
EFM	Command or Query – Use to configure EDMAC Framing Mode (Off, Master, Slave).
ESA	Command or Query – (For EDMAC Master only) When used as a query, it retrieves EDMAC slave address. When used as a command, it sets the EDMAC Slave Address range.
FLT	Query only – The unit returns the current <b>highest-priority</b> fault and status codes for the unit (hardware), Tx Traffic, Rx Traffic and ODU.
FRM	Command or Query – Configure the unit's framing mode (Unframed, EDMAC, EDMAC-2).
ODU	Command or Query – Enable or disable communications, via the FSK link, with a Comtech EF Data transceiver.
REB	Query only – Returns the value of Eb/No of the remote demod
RNE	Query only – Unit returns the oldest 5 Stored Events which have not yet been read over the remote control.





### 10.3.1.1 SELECT: (Main) Menu

```
SELECT: Config Monitor
Test Info Save/Load Util
```

The table that follows identifies the commands comprising the CDM/R-570AL main menu, and the content section in this manual where explicit information may be referenced, either in this chapter or in **Chapter 6. FRONT PANEL OPERATION**:

Menu Branch	Chapter Sect.	Function
Config	6.3.2, 10.3.3.1	Use to fully configure the modem <b>and the ODU</b> .
Monitor	6.3.3, 10.3.1.3	Used to monitor the alarm status of the modem <b>and the ODU</b> , to view the log of stored events, and to display the Receive Parameters screen.
Test	6.3.4	Used to invoke one of several test modes (loopbacks, for example).
Info	6.3.5	(Information) Used to view information on the modem, without having to go into configuration screens.
Save/Load	6.3.6	Used to save (store) and to load (retrieve) up to 10 different modem configurations.
Util	6.3.7	(Utility) Used to perform miscellaneous functions, such as setting the real-time clock, adjusting the display brightness, etc.

For ODU operation, use the ◀ ▶ arrow keys to select **Config** or **Monitor**, and then press **ENTER**.

#### 10.3.1.1.1 (SELECT:) Config (Configuration)

```
CONFIG: Rem All Tx Rx CEx
Frame TI Ref Msk CnC ODU
```

For ODU operations, use the ◀ ▶ arrow keys to select **Msk** or **ODU**, and then press **ENTER**.

##### 10.3.1.1.1.1 CONFIG: Msk (Alarm Masking)

```
Alarm Mask: Transmit
Receive Ref BUC LNB (◀▶)
```

For ODU operations, use the ◀ ▶ arrow keys to select **BUC** or **LNB**, and then press **ENTER**.

##### 10.3.1.1.1.2 (CONFIG: Alarm Mask) BUC

```
BUC Alarm:
Active Masked (◀▶,ENT)
```

Use the ◀ ▶ arrow keys to select **Active** or **Masked**, and then press **ENTER**. By selecting **Masked**, no alarm will be generated.

### 10.3.1.1.1.3 (CONFIG: Alarm Mask) LNB

```
LNB Alarm:  
Active Masked (< >,ENTER)
```

Use the < > arrow keys to select **Active** or **Masked**, and then press **ENTER**. By selecting **Masked**, no alarm will be generated.

### 10.3.1.1.2 CONFIG: ODU (Outdoor Unit)

```
ODU (Outdoor Unit):  
BUC LNB (< >,ENTER)
```

Use the < > arrow keys to choose between controlling and monitoring a **BUC** or an **LNB**. Press **ENTER** when done

### 10.3.1.1.2.1 (CONFIG: ODU) BUC

```
BUC: M&C-FSK DC-Power  
10MHz Alarm LO Mix (< >)
```

Use the < > arrow keys to select **M&C-FSK**, **DC-Power**, **10MHz**, **Alarm**, **LO**, or **Mix**, and then press **ENTER**.

### 10.3.1.1.2.1.1 (CONFIG: ODU) BUC: M&C-FSK

```
BUC M&C (FSK) : FSK-Comms  
Address Tx-On/Off (< >)
```

When an FSK-capable BUC is employed, use this menu to define, control and monitor the FSK setup. Use the < > arrow keys to select **Comms**, **Address**, or **Tx-On/Off**. Press **ENTER** when done

### (CONFIG: ODU) BUC: M&C-FSK > FSK-Comms

```
BUC M&C FSK Comms :  
On Off (< >,ENTER)
```

Use the < > arrow keys to select FSK communications between the modem and BUC as **On** or **Off**. Press **ENTER** when done.

### (CONFIG: ODU) BUC: M&C-FSK > Address

```
BUC FSK Address: 01  
(▲ ▼,ENTER)
```

To enter the logical address of the BUC: Use the ▲ ▼ arrow keys to edit the value of the address – the valid range is from **01** to **15** – and then press **ENTER**.

### (CONFIG: ODU) BUC: M&C-FSK ► TX-On/Off

```
BUC RF Output:
On Off (◀ ▶,ENTER)
```

Use the ◀ ▶ arrow keys to select the BUC RF Output as **On** or **Off**. Press **ENTER** when done.

### 10.3.1.1.2.1.2 (CONFIG: ODU) BUC: DC-Power

```
BUC DC Power:
On Off (◀ ▶,ENTER)
```

Use the ◀ ▶ arrow keys to select the BUC DC Power as **On** or **Off**. Press **ENTER** when done.

### 10.3.1.1.2.1.3 (CONFIG: ODU) BUC: 10MHz

```
BUC 10MHz Reference:
On Off (◀ ▶,ENTER)
```

Use the ◀ ▶ arrow keys to select the BUC 10 MHz Frequency Reference as **On** or **Off**. Press **ENTER** when done.

### 10.3.1.1.2.1.4 (CONFIG: ODU) BUC: Alarm

```
Set BUC Current Alarm:
Upper Lower (◀ ▶,ENTER)
```

Use this menu to define the upper and lower limits of the BUC current 'window.' If the measured BUC current falls outside this window, an alarm is generated.

Use the ◀ ▶ arrow keys to select **Upper** or **Lower**, and then press **ENTER**.

### (CONFIG: ODU) BUC: Set BUC Current Alarm ► Upper

```
BUC Current Alarm Upper
Limit:1200mA (◀ ▶,▲ ▼,ENT)
```

**To edit the BUC Current Alarm Upper Limit:** First, use the ◀ ▶ arrow keys to select a digit to edit, and then use the ▲ ▼ arrow keys to change the value of that digit. The valid range of current is from **500** to **4000** mA. Press **ENTER** when done.

### (CONFIG: ODU) BUC: Set BUC Current Alarm ► Lower

```
BUC Current Alarm Lower
Limit:1200mA (◀ ▶,▲ ▼,ENT)
```

**To edit the BUC Current Alarm Lower Limit:** First, use the ◀ ▶ arrow keys to select a digit to edit, and then use the ▲ ▼ arrow keys to change the value of that digit. The valid range of current is from **0** to **3000** mA. Press **ENTER** when done.

### 10.3.1.1.2.1.5 (CONFIG: ODU) BUC: LO

```
BUC LO Frequency:
12000 MHz (< >, ▲ ▼, ENTER)
```

**To edit the value of the BUC LO (Lockout) Frequency:** First, use the < > arrow keys to select a digit to edit, and then use the ▲ ▼ arrow keys to change the value of that digit. The valid range is from **3000** to **65000** MHz. Press **ENTER** when done.



**This value is used to display the RF frequency of the modem/BUC combination. If the default value of 00000 is entered here, then no RF frequency will be displayed on the CONFIG: Tx → Frq (Tx Frequency) menu.**

### 10.3.1.1.2.1.6 (CONFIG: ODU) BUC: Mix

```
BUC Frequency Mix:
High-Side Low-Side (< >)
```

Use the < > arrow keys to define the sense of the frequency translation as **High-Side** or **Low-Side**. Press **ENTER** when done.

### 10.3.1.1.2.2 (CONFIG: ODU) LNB

```
LNB: DC-Voltage 10MHz
Alarm LO Mix (< >, ENT)
```

Use the < > arrow keys to select **DC-Voltage**, **10MHz**, **Alarm**, **LO**, or **Mix**, and then press **ENTER**.

#### 10.3.1.1.2.2.1 (CONFIG: ODU) LNB: DC-Voltage

```
LNB DC Supply Voltage:
13 volts (< >, ENTER)
```

Use the ▲ ▼ arrow keys to select the value of the LNB DC power supply output voltage as **13 volts**, **18 volts**, **24 volts**, or **Power OFF**. Press **ENTER** when done.

#### 10.3.1.1.2.2.2 (CONFIG: ODU) LNB: 10MHz

```
LNB 10MHz Reference:
On Off (< >, ENTER)
```

Use the < > arrow keys to select the 10MHz frequency reference for the LNB as **On** or **Off**. Press **ENTER** when done.

### 10.3.1.1.2.2.3 (CONFIG: ODU) LNB: Alarm

```
Set LNB Current Alarm:
Upper Lower (< >, ENTER)
```

Use this menu to define the upper and lower limits of the LNB current 'window.' If the measured LNB current falls outside this window, an alarm is generated.

Use the < > arrow keys to select **Upper** or **Lower**. Press **ENTER** when done.

#### (CONFIG: ODU) LNB: Set LNB Current Alarm ▶ Upper

```
LNB Current Alarm Upper
Limit: 200mA (< >, ▲ ▼, ENT)
```

**To edit the LNB Current Alarm Upper Limit:** First, use the < > arrow keys to select a digit to edit, and then use the ▲ ▼ arrow keys to change the value of that digit. The valid range of current is from **50** to **600** mA. Press **ENTER** when done.

#### (CONFIG: ODU) LNB: Set LNB Current Alarm ▶ Lower

```
LNB Current Alarm Lower
Limit: 050mA (< >, ▲ ▼, ENT)
```

**To edit the LNB Current Alarm Lower Limit:** First, use the < > arrow keys to select a digit to edit, and then use the ▲ ▼ arrow keys to change the value of that digit. The valid range of current is from **10** to **400** mA. Press **ENTER** when done.

### 10.3.1.1.2.2.4 (CONFIG: ODU) LNB: LO

```
BUC LO Frequency:
12000 MHz (< >, ▲ ▼, ENTER)
```

**To edit the value of the LNB LO (Lockout) Frequency:** First, use the < > arrow keys to select a digit to edit, and then use the ▲ ▼ arrow keys to change the value of that digit. The valid range is from **3000** to **65000** MHz. Press **ENTER** when done.



**This value is used to display the RF frequency of the modem/BUC combination. If the default value of 00000 is entered here, then no RF frequency will be displayed on the CONFIG: Rx → Frq (Rx FREQUENCY) menu.**

### 10.3.1.1.2.2.5 (CONFIG: ODU) LNB: Mix

```
LNB Frequency Mix:
High-Side Low-Side (< >)
```

Use the ◀ ▶ arrow keys to define the sense of the frequency translation as **High-Side** or **Low-Side**. Press **ENTER** when done.

### 10.3.1.2 (SELECT:) Monitor

```
MONITOR: Alarms Rx-Params
Event-Log Stats AUPC ODU
```

For ODU operation, use the ◀ ▶ arrow keys to select **Alarms** or **ODU**, and then press **ENTER**.

#### 10.3.1.2.1 MONITOR: Alarms

```
Live Alarms:Unit Receive
Transmit ODU (< >,ENTER)
```



The CDM/R-570AL uses a system of Fault Prioritization. This system cuts down significantly on unwanted and irrelevant fault reporting. Only the highest priority fault is displayed in each category. For example, if the demodulator is unlocked, it is irrelevant if there are other Rx faults present. If the demodulator then locks, but there is a fault of a lower priority present, this will then be displayed. This also holds true for the faults reported via the remote control.

SUMMARY OF PRIORITIZED ODU FAULTS	
<b>ODU Status</b>	1) BUC PLL lock fault 2) BUC Current Out of Limits 3) BUC Voltage Out of Limits 4) LNB Current Out of Limits 5) LNB Voltage Out of Limits 6) BUC Temperature Alarm 7) BUC Software Checksum Error

For ODU Live Alarms, use the ◀ ▶ arrow keys to select **ODU**, and then press **ENTER**.

### 10.3.1.2.1.1 (MONITOR: Live Alarms) ODU

```
ODU Alarms: BUC Current
Out of Limits (ENT)
```

```
ODU Alarms: None
(ENT)
```

This read-only screen indicates if there are any ODU Alarms present. If a prioritized fault is present it is displayed here (as per the **SUMMARY OF PRIORITIZED ODU FAULTS** table). If not, the screen displays **None**.

Press **ENTER** or **CLEAR** to return to the previous menu.

### 10.3.1.2.2 MONITOR: ODU

```
Outdoor Unit Monitor:
BUC LNB (< >, ENTER)
```



The screen shots that follow depict sample configurations – the actual values and settings will vary and they are dependent on the ODU configuration in use. Typical for all nested screens, press **ENTER** or **CLEAR** to return to the Outdoor Unit Monitor submenu.

Use the ◀ ▶ arrow keys to select **BUC** or **LNB**, and then press **ENTER**.

#### 10.3.1.2.2.1 (MONITOR: Outdoor Unit Monitor) BUC

```
BUC:DC=47.8V,3.25A SW=05
T=+38C PLL=F1t Pwr=02.1W
```

This read-only screen displays the following parameters:

Display Line	Item	Description
Top	DC	<b>(DC Power)</b> If a BUC supply is installed, menu displays measured BUC supply voltage and load current, measured at the Tx-IF connector.
	SW	If BUC FSK is enabled, menu displays the M&C software version of the BUC.
Bottom	T	<b>(Temperature)</b> If BUC FSK is enabled, menu displays BUC ambient temperature in °C.
	PLL	If BUC FSK is enabled, menu displays the fault status of the BUC PLL synthesizers.
	Pwr	<b>(Output Power)</b> If BUC FSK is enabled, menu displays the output power as measured by the BUC power monitor.



### 10.3.1.2.2.2 (MONITOR: Outdoor Unit Monitor) LNB

LNB Voltage: 13.1 volts  
LNB Current: 235 mA (ENT)

This read-only screen displays the LNB Voltage and LNB Current parameters.

## 10.3.2 BUC and LNB M&C via the CDM-570A HTTP Interface



### Chapter 7. ETHERNET-BASED REMOTE PRODUCT MANAGEMENT

Figure 10-14 shows the menu tree for ODU-accessible features when using the CDM/R-570AL (L-Band) Satellite Modem. Modem operations not specific to CDM/R-570AL BUC or LNB operation appear dimmed in this diagram and are explained in Chapter 7. This menu tree depicts the CDM-570A HTTP Interface as it appears with all FAST Features activated, and the optional IP Packet Processor **installed and active**.

See Sect. 10.2.2 for ODU operations applicable to the CDM-570A (70/140 MHz) and its use with Comtech EF Data CSAT/KST Transceivers.

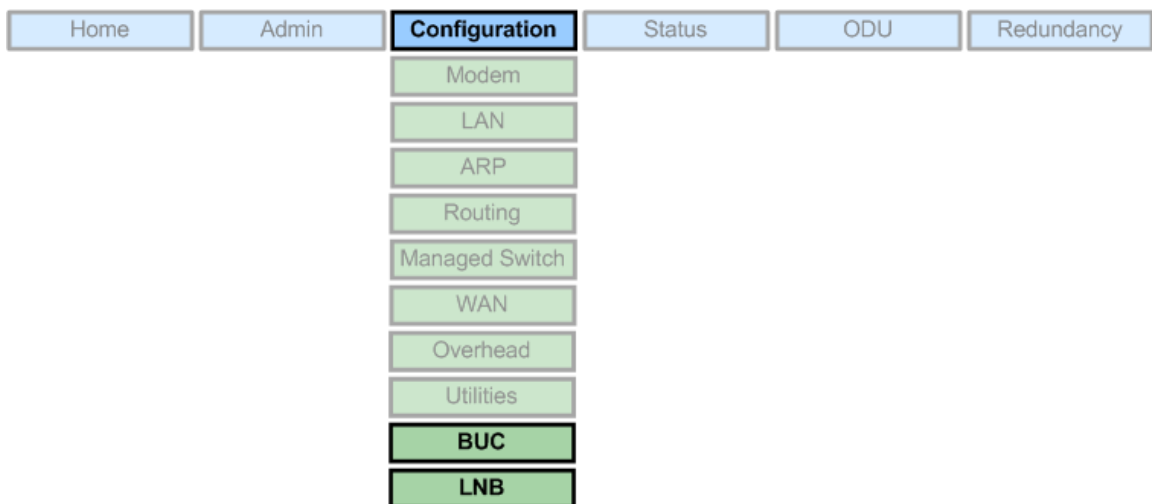

Figure 10-14. CDM-570A HTTP Interface – ODU BUC/LNB Menu Tree

### 10.3.2.1 ODU (BUC, LNB) Pages

When properly configured to operate with a BUC or LNB, the **'Configuration | BUC'** and **'Configuration LNB'** pages allow configuration of the operating parameters specific to the active unit.

Click the **'Configuration'** tab, and then click the **'BUC'** or **'LNB'** tab to continue.

#### 10.3.2.1.1 Configuration | BUC

Use this page to configure BUC parameters, and to display the BUC status for L-Band operation.

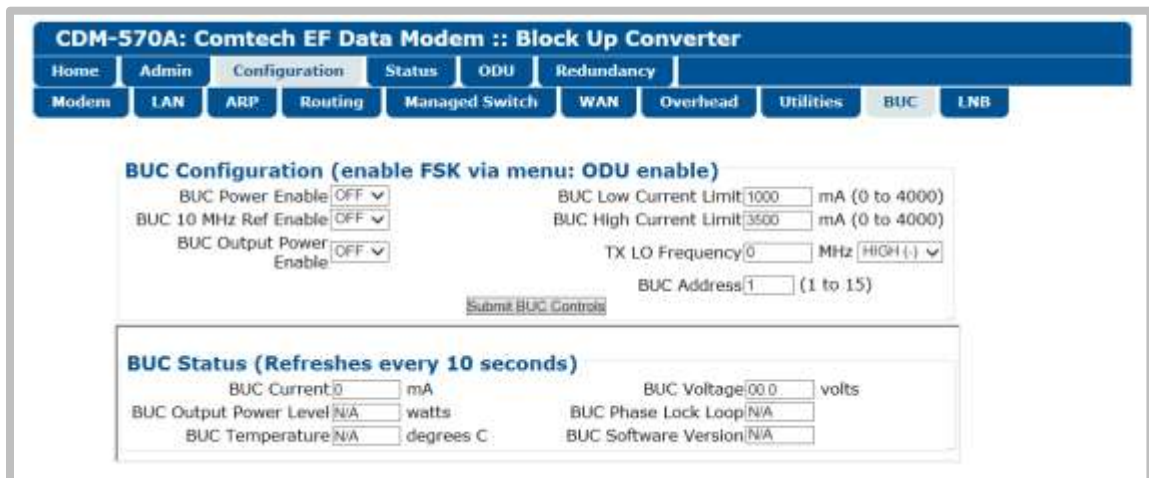

Figure 10-15. Configuration | BUC Page

#### BUC Configuration

- Use the drop-down lists to set BUC Power Enable, 10 MHz Ref Enable, and Output Power Enable operations as ON or OFF.
- Assign the BUC Low Current Limit and High Current Limit values ranging from 0 to 4000 mA.
- Assign the Tx Lockout Frequency and designate the value as a HIGH (+) or LOW (-) limit.
- Assign a BUC Address from 0 to 15.

Click **[Submit BUC Controls]** to save any changes made to this section.

#### BUC Status

The values displayed in this section are **read-only** and cannot be changed. This information automatically updates every 10 seconds.

### 10.3.2.1.2 Configuration | LNB

Use this page to configure LNB parameters, and to display the LNB status for L-Band operation.

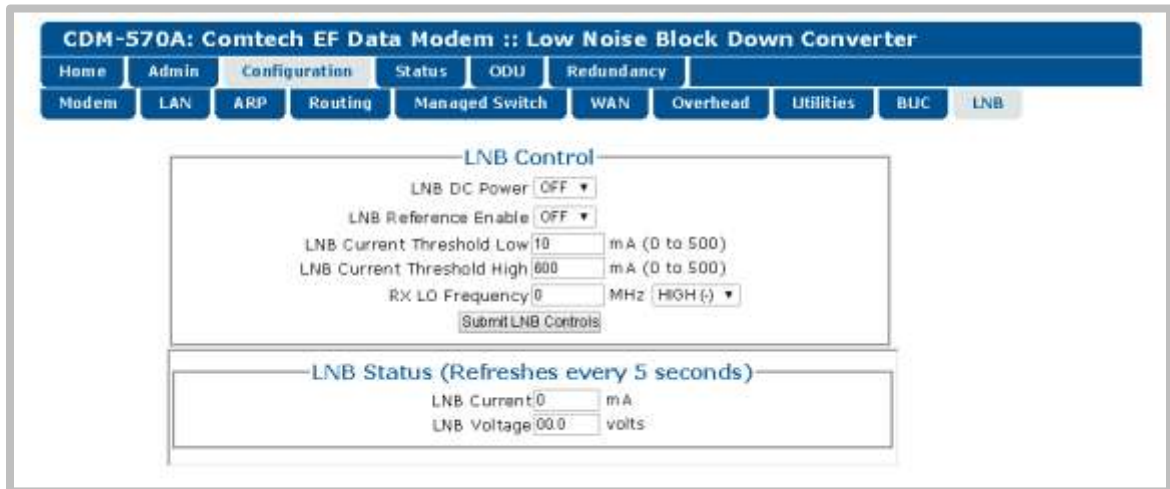

The screenshot shows the 'CDM-570A: Comtech EF Data Modem :: Low Noise Block Down Converter' configuration page. The 'LNB' tab is selected in the top navigation bar. The 'LNB Control' section contains the following fields:

- LNB DC Power: OFF (dropdown)
- LNB Reference Enable: OFF (dropdown)
- LNB Current Threshold Low: 10 mA (0 to 500)
- LNB Current Threshold High: 600 mA (0 to 500)
- RX LO Frequency: 0 MHz (HIGH (+) dropdown)

A 'Submit LNB Controls' button is located below these fields. The 'LNB Status (Refreshes every 5 seconds)' section displays the following read-only values:

- LNB Current: 0 mA
- LNB Voltage: 00.0 volts

Figure 10-16. Configuration | LNB Page

#### LNB Control

Use the drop-down lists to set BUC LNB DC Power and LNB Reference Enable operations as ON or OFF.

- Assign the LNB Low Current Threshold and High Current Threshold values ranging from 0 to 500 mA.
- Assign the Rx Lockout Frequency and designate the value as a HIGH (+) or LOW (-) limit.

Click **[Submit LNB Controls]** to save any changes made to this section.

#### LNB Status

The values displayed in this section are **read-only** and cannot be changed. This information automatically updates every 5 seconds.

### 10.3.3 CDM/R-570AL BUC and LNB M&C via Serial Remote Control Commands/Queries



#### Chapter 8. SERIAL-BASED REMOTE PRODUCT MANAGEMENT

The operands available through CDM/R-570AL Serial-based Remote Product Management are identified in the following table – details on using these ODU-specific remote commands and queries are explicitly defined in **Chapter 8**.

Operand	Description
RNE	Query only – the unit returns the oldest 5 Stored Events which have not yet been read over the remote control.
OGC	Command or Query – ODU Global Configuration of CDM/R-570AL
FLT	Query only – Unit returns the current <b>highest-priority</b> fault and status codes for the unit (hardware), Tx Traffic, Rx Traffic and ODU

# Appendix A. CABLE DRAWINGS

## A.1 Overview

The CDM-570A/570AL's available EIA-530 standard pinout is popular in many applications. However, for some existing EIA-422/449 and V.35 users, conversion is necessary. For these situations:

- **Figure A-1** shows the line detail for a EIA-530 to EIA-422/449 DCE conversion cable (Comtech EF Data part number CA/WR12753-x)
- **Figure A-2** shows the line detail for a EIA-530 to V.35 DCE conversion cable (Comtech EF Data part number CA/WR12685-x)

### A.1.1 EIA-530 to EIA-422/449 Data Cable

WIRE LIST			TWISTED PAIR
FROM	TO	SIGNAL	
J1-3	P1-6	RD-A	X
J1-16	P1-24	RD-B	
J1-2	P1-4	SD-A	X
J1-14	P1-22	SD-B	
J1-24	P1-17	TT-A	X
J1-11	P1-35	TT-B	
J1-15	P1-5	ST-A	X
J1-12	P1-23	ST-B	
J1-17	P1-8	RT-A	X
J1-9	P1-26	RT-B	
J1-4	P1-7	RS-A	X
J1-19	P1-25	RS-B	
J1-5	P1-9	CS-A	X
J1-13	P1-27	CS-B	
J1-8	P1-13	RR-A	X
J1-10	P1-31	RR-B	
J1-6	P1-11	DM-A	X
J1-22	P1-29	DM-B	
J1-20	N/C	SPARE	
J1-23	N/C	SPARE	
J1-18	N/C	SPARE	
J1-21	N/C	SPARE	
J1-25	N/C	SPARE	
J1-7	P1-20	SIGGND	X
J1-1	P1-1	SHLD	

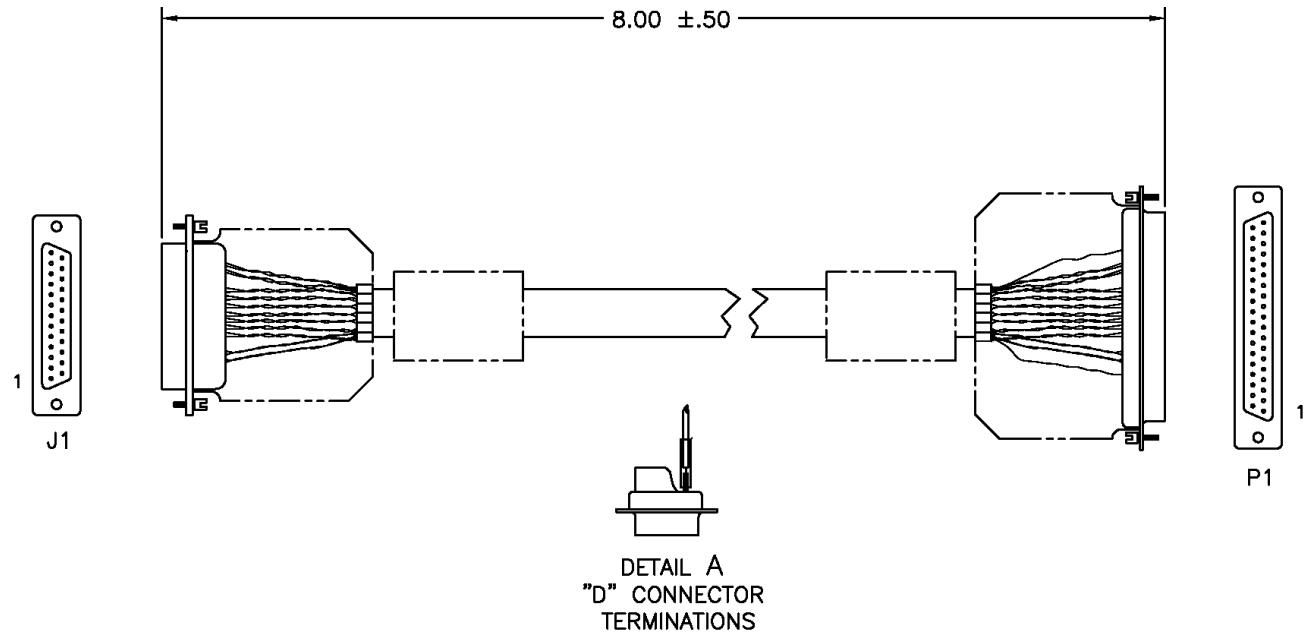
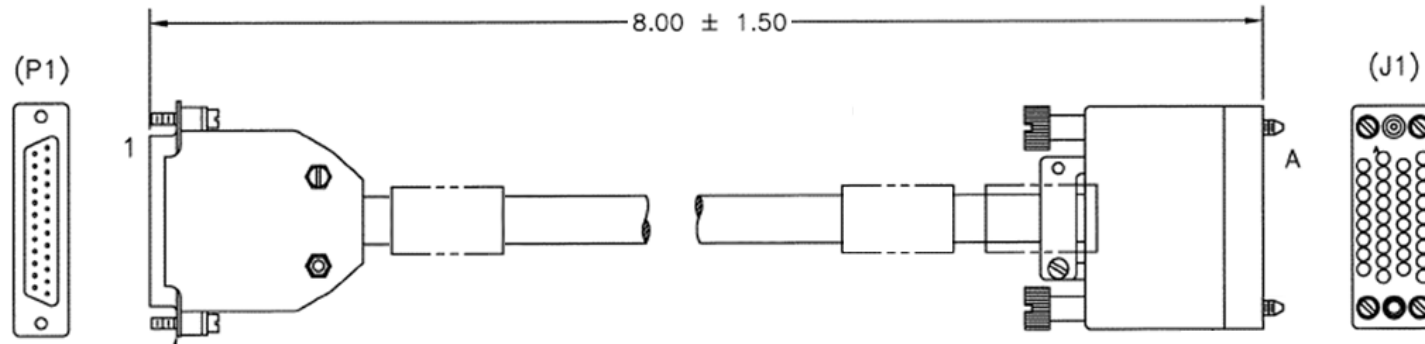

Figure A-1. EIA-530 to EIA-422/449 DCE Conversion Cable (CEFD P/N CA/WR12753-1)

### A.1.2 EIA-530 to V.35 DCE Conversion Cable



WIRE LIST			
FROM	TO	SIGNAL NAME	TWISTED PR.
P1-1	J1-A	SHIELD GND	
P1-7	J1-B	SIGNAL GND	
P1-2	J1-P	SD-A	X
P1-14	J1-S	SD-B	
P1-24	J1-U	SCTE-A	X
P1-11	J1-W	SCTE-B	
P1-15	J1-Y	SCT-A	X
P1-12	J1-AA	SCT-B	
P1-3	J1-R	RD-A	X
P1-16	J1-T	RD-B	
P1-17	J1-V	SCRA	X
P1-9	J1-X	SCRB	
P1-4	J1-C	RTS	X
P1-5	J1-D	CTS	
P1-6	J1-E	DSR	X
P1-8	J1-F	RLSD	



Figure A-2. EIA-530 to V.35 DCE Conversion Cable (CEFD P/N CA/WR12685-1)





# Appendix B. FEC (FORWARD ERROR CORRECTION) OPTIONS

---

## B.1 Overview

The CDM-570A/570AL Satellite Modem is equipped with VersaFEC (short-block LDPC), Turbo Product Code (TPC), Viterbi, Reed-Solomon (Closed Network), and Trellis with concatenated Reed-Solomon Forward Error Correction encoders/decoders. The constraint lengths and encoding polynomials are Closed Network compatible with the vast majority of existing modems from other manufacturers. Comtech EF Data has performed compatibility testing to ensure interoperability.

Turbo Product 0.95 Code Rate (TPC) is available via an optional plug-in card.

While the performance of LDPC is exceptional in terms of coding gain, its higher latency is considered disadvantageous in some applications. For this reason, Comtech EF Data and Comtech AHA Enterprise Products Group have jointly developed a family of short-block LDPC codes called **VersaFEC**<sup>®</sup>. (The name VersaFEC is a trademark registered to Comtech AHA Enterprise Products Group.)

VersaFEC is ideal for lower data rates that demand the shortest possible latency, and is available as a FAST option. It represents the best Forward Error Correction (FEC) technology currently available, and is offered with a sufficient range of code rates and modulation types that link performance can be optimized under almost any conditions.

## B.2 Viterbi

The combination of convolutional coding and Viterbi decoding has become an almost universal standard for satellite communications. The CDM-570A/570AL complies with the Intelsat IESS 308/309 standards for Viterbi decoding with a constraint length of seven. This is a de facto standard, even in a closed network environment, which means almost-guaranteed interoperability with other manufacturer's equipment. It provides very useful levels of coding gain, and its short decoding delay and error-burst characteristics make it particularly suitable for low data rate coded voice applications. It has a short constraint length, fixed at 7, for all code rates. (The constraint length is defined as the number of output symbols from the encoder that are affected by a single input bit.)

By choosing various coding rates (Rate 1/2, 3/4 or 7/8) the user can trade off coding gain for bandwidth expansion. Rate 1/2 coding gives the best improvement in error rate, but doubles the transmitted data rate, and hence doubles the occupied bandwidth of the signal. Rate 7/8 coding, at the other extreme, provides the most modest improvement in performance, but only expands the transmitted bandwidth by 14%.

A major advantage of the Viterbi decoding method is that the performance is independent of data rate, and does not display a pronounced threshold effect (i.e., does not fail rapidly below a certain value of  $E_b/N_0$ ). Note that, in BPSK mode, the CDM-570A/570AL only permits a coding rate of 1/2. Because the method of convolutional coding used with Viterbi, the encoder does not preserve the original data intact, and is called non-systematic.

**Table B-1. Viterbi Decoding Summary**

FOR	AGAINST
<ul style="list-style-type: none"> <li>• Good BER performance – very useful coding gain.</li> <li>• Almost universally used, with de facto standards for constraint length and coding polynomials.</li> <li>• Shortest decoding delay (~100 bits) of any FEC scheme – good for coded voice, VOIP, etc.</li> <li>• Short constraint length produce small error bursts – good for coded voice.</li> <li>• No pronounced threshold effect – fails gracefully.</li> <li>• Coding gain independent of data rate.</li> </ul>	<p>Higher coding gain possible with other methods.</p>

---

## B.3 Reed-Solomon (RS) Outer Codec

The concatenation of an outer Reed-Solomon (RS) Codec with Viterbi decoder first became popular when it was introduced by Intelsat in the early 1990s. It permits significant improvements in error performance without significant bandwidth expansion. The coding overhead added by the RS outer Codec is typically around 10%, which translates to a 0.4 dB power penalty for a given link.

RS codes are block codes – as opposed to Viterbi, which is convolutional; in order to be processed correctly, the data must be framed and de-framed. Additionally, RS codes are limited in how well they can correct errors that occur in bursts. This, unfortunately, is the nature of the uncorrected errors from Viterbi decoders, which produce clusters of errors that are multiples of half the constraint length. For this reason, the data must be interleaved following RS encoding, and is then de-interleaved prior to decoding. This ensures that a single burst of errors leaving the Viterbi decoder is spread out over a number of interleaving frames, so errors entering the RS decoder do not exceed its capacity to correct those errors.

### B.3.1 Closed Network Modes

A 220,200 code is used in transparent closed network modes, and a 200,180 code is used in framed (EDMAC) modes. (220,200 means that data is put into blocks of 220 bytes, of which 200 bytes are data, and 20 bytes are FEC overhead.)

When Viterbi decoding is used as the primary FEC, an interleaver depth of 4 is used. The increase in coding gain is at the expense of delay. The interleaving/de-interleaving delay and the delay through the decoder itself can be as high as 25 kbits. At very low data rates, this equates to several seconds, making it highly unsuitable for voice applications. Additionally, the de-interleaver frame synchronization method can add significantly to the time taken for the demodulator to declare acquisition.

## B.4 Trellis Coding Modulation (TCM) (FAST Option)



### Trellis Coding Modulation requires the 8-PSK/8-QAM FAST option.

In the other FEC methods described here, the processes of coding and modulation are independent – the FEC codec has no knowledge of, or interaction with the modulator. However, there are schemes in which the coding and modulation are combined together, where the encoder places FEC symbols in a precise manner into the signal constellation. This can yield an overall improvement in performance, and is used in higher-order modulation schemes, such as 8-PSK, 16-PSK, 16-QAM, etc.

When convolution coding is used, the overall coded modulation approach is referred to as Trellis Coded Modulation (TCM). Ungerboeck was an early pioneer and developed optimum mapping and decoding schemes. However, the decoding scheme was seen as complex and expensive, and Qualcomm Inc. developed a variation on the theme that uses a Viterbi decoder at the core, surrounded by adjunct processing. The scheme, called pragmatic Trellis Coded Modulation, is able to achieve performance very close to the optimum Ungerboeck method, but with far less complexity.

As more and more high power transponders are put in to service, Intelsat recognized that the transponders are no longer power limited, but bandwidth limited. In order to maximize transponder capacity, 8-PSK was looked at as a method of reducing the occupied bandwidth of a carrier, and Qualcomm's pragmatic TCM, at Rate 2/3, was adopted.

A Rate 2/3 8-PSK/TCM carrier occupies only 50% of the bandwidth of a Rate 1/2 QPSK carrier. However, the overall coding gain of the scheme is not adequate by itself, so Intelsat's IESS-310 specification requires that the scheme be concatenated with an outer RS codec. When combined, there is a threshold value of  $E_b/N_0$  of around 6 dB and, above approximately 7 dB, the bit error rate is better than  $1 \times 10^{-8}$ .

The detractions of the concatenated RS approach apply here also, along with more stringent requirements for phase noise and group delay distortion – the natural consequences of the higher-order modulation.

The CDM-570A/570AL implements a Closed Network version of Rate 2/3 8-PSK/TCM/RS, using either the 220, 200 or 200,180 Reed-Solomon outer codes. Although not compatible, it provides identical performance to the Open Network IESS-310 standard.

**Table B-2. 8-PSK/TCM Coding Summary**

FOR	AGAINST
Exceptionally bandwidth efficient compared to QPSK.	<ul style="list-style-type: none"> <li>• Needs concatenated RS outer codec to give acceptable coding gain performance.</li> <li>• Demod acquisition threshold much higher than for QPSK.</li> <li>• 8-PSK is more sensitive to phase noise and group delay distortion than QPSK.</li> </ul>

---

## B.5 Turbo Product Codec (FAST Option)

Turbo coding is an FEC technique, developed within the last few years, which delivers significant performance improvements compared to more traditional techniques. Two general classes of Turbo Codes have been developed, Turbo Convolutional Codes (TCC), and Turbo Product Codes (TPC, a block coding technique). Comtech EF Data has chosen to implement an FEC codec based on TPC. A Turbo Product Code is a 2 or 3 dimensional array of block codes. Encoding is relatively straightforward, but decoding is a very complex process requiring multiple iterations of processing for maximum performance to be achieved.

Unlike the popular method of concatenating an RS codec with a primary FEC codec, Turbo Product Coding is an entirely stand-alone method. It does not require the complex interleaving/de-interleaving of the RS approach, and consequently, decoding delays are significantly reduced. Furthermore, the traditional concatenated RS schemes exhibit a very pronounced threshold effect – a small reduction in  $E_b/N_0$  can result in total loss of demod and decoder synchronization. TPC does not suffer from this problem – the demod and decoder remain synchronized down to the point where the output error rate becomes unusable. This is considered to be a particularly advantageous characteristic in a fading environment. Typically, in QPSK, 8-PSK and 16-QAM TPC modes the demod and decoder can remain synchronized **2 – 3 dB below** the Viterbi/Reed-Solomon or TCM cases.

### B.5.1 TPC Overview

In the past few years there has been an unprecedented resurgence in interest in FEC technology. The start of this new interest has its origins in the work done by Claude Berrou et al, and the 1993 landmark paper, Near Shannon Limit Error Correcting Coding and Decoding – Turbo Codes. FEC is considered an essential component in all wireless and satellite communications in order to reduce the power and bandwidth requirements for reliable data transmission.

Claude Shannon, considered by many to be the father of modern communications theory, first established the concept of Channel Capacity in his 1948 paper A Mathematical Theory of Communication. This places an absolute limit on how fast it is possible to transmit error-free data within a channel of a given bandwidth, and with given noise conditions within that channel. He concluded that it would only be possible to approach this limit through the use of source encoding – what is familiar today as FEC.

Shannon postulated that if it were possible to store every possible message in the receiver, finding the stored message that most closely matched the incoming message would yield an optimum decoding method. However, for all but the shortest bit sequences, the memory required for this, and the time taken to perform the comparisons, makes this approach impractical. For all practical purposes, the memory requirement and the decoding latency become infinite.

For many years, there were few advances in the quest to approach the Shannon Limit. The Viterbi algorithm heralded a major step forward, followed in the early 1990s by the concatenation of a Viterbi decoder with Reed-Solomon hard-decision block codes. It remained clear, however, that the Shannon Limit was still an elusive target.

Berrou's work on Turbo Codes showed, through the use of an ingeniously simple approach (multiple, or iterative decoding passes) that it is possible to achieve performance close to the Shannon Limit. Berrou's early work dealt exclusively with iteratively-decoded convolutional codes (Turbo Convolutional Coding, or TCC), but in time the iterative approach was applied to a particular class of block codes called Product Codes – hence Turbo Product Coding (TPC). TPC exhibits inherently low decoding latency compared with TCC, and so is considered much more desirable for 2-way, interactive satellite communications applications.

In August 1999, Comtech became the first company in the world to offer satellite modems that incorporate TPC. Since its inception, Comtech has continued to develop and refine its implementation of TPC in its products, and now offers a comprehensive range of code rates (from Rate 5/16 to Rate 0.95) and modulations (from BPSK to 16-QAM).

## B.6 VersaFEC (Short-block LDPC)

VersaFEC is a system of short-block LDPC codes that have been designed as a low-latency alternative to both Comtech's existing LDPC codes, and to the system set forth in the DVB-S2 specification (EN 302307) ratified by ETSI.

Since the introduction of Comtech's LDPC, considerable research has been carried out to find ways to reduce the block size of LDPC (and hence its latency) while preserving the coding gain performance very close to the Shannon bound.

The set of VersaFEC codes was developed with two distinct purposes:

1. To provide an expanded choice of combinations of modulation and coding that maintain the same coding gain performance as Comtech's existing LDPC, while significantly reducing latency. The existing LDPC approach (and DVB-S2 short-block) uses blocks that are 16 kbits in length. VersaFEC, on the other hand, uses block sizes that vary between 2k and 8.2 kbits, and at the same time reduces latency still further through a novel design approach.
2. To provide combinations of modulation and coding (ModCods) that are suitable not only for Constant Coding and Modulation (CCM) applications, but are also the basis for Comtech Comtech EF Data and Comtech AHA Enterprise Products Group's patent-pending Adaptive Coding and Modulation (ACM) system. The VersaFEC ACM feature requires activation of the appropriate FAST codes.



### Appendix P.6. ADAPTIVE CODING AND MODULATION OPTION

There are 12 ModCods in the VersaFEC set (see **Table B-3**). The modulation types (BPSK, QPSK, 8-QAM and 16-QAM) and the code rates have been chosen to give a continuous progression of performance in terms of Eb/No and spectral efficiency – an essential aspect of a well-engineered ACM system.

**Table B-3. The VersaFEC ModCod Set**

ModCod	Modulation	Code Rate	Spectral efficiency, bps/Hz	Block size, bits	Typical Eb/No, for BER = $5 \times 10^{-8}$	Latency at 64 kbps, in milliseconds	Min. Data Rate (kbps)	Max. Data Rate (Mbps)
00	BPSK	0.488	0.49	2k	2.4 dB	26	2.4	1.462
01	QPSK	0.533	1.07	4.1k	2.2 dB	53	5.2	3.200
02	QPSK	0.631	1.26	4.1k	2.7 dB	59	6.1	3.785
03	QPSK	0.706	1.41	4.1k	3.4 dB	62	6.8	4.233
04	QPSK	0.803	1.61	4.1k	3.8 dB	66	7.8	4.818
05	8-QAM	0.642	1.93	6.1k	4.6 dB	89	9.3	5.782
06	8-QAM	0.711	2.13	6.1k	5.2 dB	93	10.3	6.401
07	8-QAM	0.780	2.34	6.1k	5.6 dB	97	11.3	7.021
08	16-QAM	0.731	2.93	8.2k	6.3 dB	125	14.1	8.776
09	16-QAM	0.780	3.12	8.2k	7.0 dB	129	15.0	9.361
10	16-QAM	0.829	3.32	8.2k	7.5 dB	131	16.0	9.946
11	16-QAM	0.853	3.41	8.2k	8.0 dB	132	16.4	10.239

As a comparison, looking at LDPC Rate 2/3 8-QAM and VersaFEC Rate 0.642 8-QAM essentially identical spectral efficiency and Eb/No performance. However, at 64 kbps, the latency has been reduced from 350 milliseconds to 89 milliseconds – a factor of 4 reduction.

The performance of the VersaFEC codes compared with the Shannon bound is shown in **Figure B-1**. This puts the performance of VersaFEC at or near the DVB-S2 performance with 16 kbit blocks.

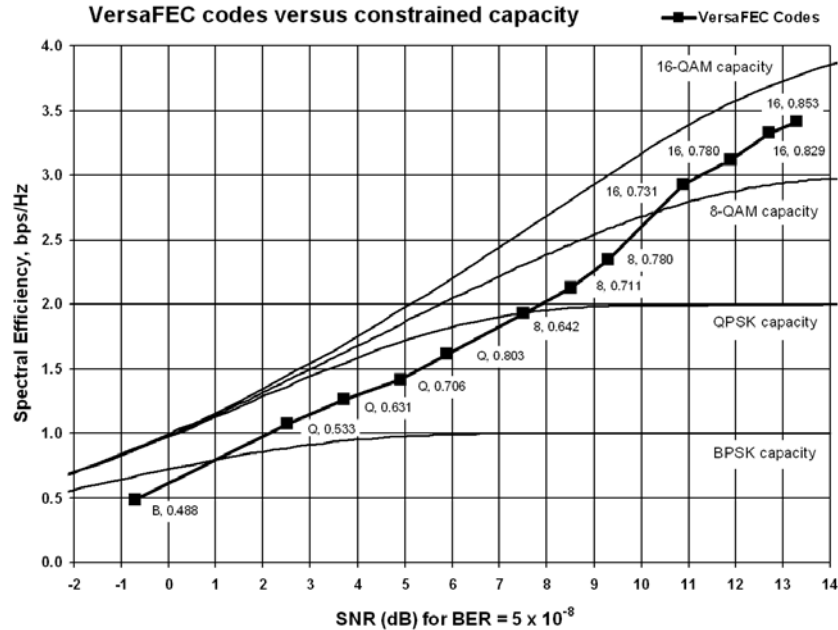

**Figure B-1. VersaFEC Codes versus Shannon Capacity**

Note that SNR is defined as  $E_b/N_0 + 10 \log(\text{Spectral Efficiency})$ .

## B.6.1 VersaFEC Extensions

### B.6.1.1 Extended CCM Codes

Two additional rates are available with the VersaFEC family of codes. Note that these are CCM (Constant Coding and Modulation) only – they are NOT included in the ACM set of ModCods.

These two codes (see **Table B-4**) have been added to fill in perceived gaps in the progression of spectral efficiency versus SNR. They do not, in fact, provide any discernible improvement in Eb/No performance (compared with their nearest neighbors in the initial VersaFEC family), but exhibit a modest SNR improvement.

**Table B-4. Extended CCM Codes**

Modulation	Code Rate	Spectral efficiency, bps/Hz	Typical Eb/No, for BER = $5 \times 10^{-8}$	Latency at 64 kbps, in milliseconds	Min. Data Rate, CCM Mode (kbps)	Max. Data Rate, CCM Mode (Mbps)
8-QAM	0.576	1.73	4.5 dB	87	8.3	5.179
16-QAM	0.644	2.58	6.5 dB	121	12.4	7.726



### B.6.1.2 Ultra-Low-Latency (ULL) Codes

Four additional ultra-short block LDPC codes address the needs of users with applications requiring even lower latency than the ‘standard’ VersaFEC code set. These codes, limited to BPSK and QPSK only (see **Table B-5**), use significantly shorter code blocks than ‘standard’ VersaFEC. As a result, the coding gain is slightly reduced. However, in terms of latency, the performance is exceptional – far lower than any other FEC method ever offered, with the exception of Viterbi.

**Table B-5. ULL Codes**

Modulation	Code Rate	Spectral efficiency, bps/Hz	Typical Eb/No, for BER = $5 \times 10^{-8}$	Latency at 64 kbps, in milliseconds	Min. Data Rate (kbps)	Max. Data Rate (Mbps)
BPSK	0.493	0.49	3.3 dB	18	2.4	1.479
QPSK	0.493	0.99	3.3 dB	19	4.8	2.959
QPSK	0.654	1.30	3.8 dB	21	6.3	3.923
QPSK	0.734	1.47	4.3 dB	23	7.0	4.405

## B.7 VersaFEC-2

Comtech EF Data's second generation VersaFEC-2 comprises 38 new ModCods, with a family of constellations. This new functionality requires the plug-in VersaFEC-2 Option Card, Firmware Version 1.5.2 or higher, and activation of the appropriate FAST codes.

- VersaFEC-2 has two modes:
  - Long Block – Maximum coding gain with higher latency.
    - 38 ModCods – BPSK to 32-ARY modulation, 9600 symbol block size.
    - Spectral efficiency up to 4.4 bps/Hz for Long Block Versa FEC-2.
  - Short Block – Slightly lower coding gain with much more latency.
    - 36 Mod Cods – BPSK to 32-ARY modulation, 1600 symbol block size.
    - Short Block performance is overall considerably better than 1<sup>st</sup> generation VersaFEC with similar latency performance.
    - Short Block deliberately limits throughput to 2 Mbps in CCM and 1 Msp in ACM. Above these limits, latency is no longer an issue, and Long Block is preferred.
    - Spectral efficiency up to 4.15 bps/Hz for Short Block VersaFEC-2.
- CCM and point-to-point ACM are supported in both modes.



### Appendix P.7. ADAPTIVE CODING AND MODULATION OPTION

- In CCM, links can be run with VersaFEC-2 in one direction, and any other supported FEC type in the other.  
Example: Rx = VersaFEC-2, Tx = TPC
- In ACM, the range of rate bit rate adaption is approximately 9:1.
- In ACM, both sides need to be VersaFEC-2, but Tx and Rx can be Short or Long – no restrictions (but NOT compatible in any way with 1<sup>st</sup> generation VersaFEC).
- If VersaFEC-2 is used on both sides of the link, even in CCM operation, the remote modem's Eb/No can be seen on the front panel display/web pages, etc., of the local modem.
- VersaFEC-2 provides five modulation types – BPSK, QPSK, 8-ARY, 16-ARY, and 32-ARY.
- VersaFEC-2 adds new circular or quasi-circular constellations for higher-order modulations (above QPSK) to replace the square VersaFEC constellations.
- Es/No span from -1.3 dB (ModCod 0) to 16.7 dB (ModCod 37), giving an average of approximately 0.45 dB per ModCod, and a 17.6 dB total span.
- The overhead associated with AUPC is eliminated. (A framed mode such as EDMAC is normally required.)
- Combined AUPC and ACM operation is possible – VersaFEC-2 permits up to 10 dB of AUPC power increase, followed by 17.6 dB of ACM range, for a total of 27.6 dB of fade protection.

**Table B-6. VersaFEC-2 ModCod Set – Long Block**

ModCod	Mod	Code Rate	Spectral Efficiency (bps/Hz)	Block Size (bits)	Typical * Es/No (SNR), for BER = $1 \times 10^{-8}$ (dB)	Latency (@ X Kbps/Mbps (ms))	Min. Data Rate, CCM Mode (kbps)	Max. Data Rate, CCM Mode (Mbps)	Min Sym Rate, ACM Mode (ksps)	Max Sym Rate, ACM Mode (Msps)
00	BPSK	0.489599	0.489	4800	-1.3	79 @ 128 kbps	18.1	1.469	37	3.0
01	QPSK	0.489599	0.977	9600	1.5	153 @ 128 kbps	36.2	2.938	37	3.0
02	QPSK	0.537459	1.075	10560	2.0	170 @ 128 kbps	39.8	3.225	37	3.0
03	QPSK	0.586319	1.173	11520	2.6	185 @ 128 kbps	43.4	3.518	37	3.0
04	QPSK	0.610749	1.221	12000	2.8	193 @ 128 kbps	45.2	3.664	37	3.0
05	QPSK	0.635179	1.270	12480	3.2	200 @ 128 kbps	47.0	3.811	37	3.0
06	QPSK	0.659609	1.319	12960	3.5	208 @ 128 kbps	48.8	3.958	37	3.0
07	QPSK	0.684039	1.368	13440	3.7	215 @ 128 kbps	50.6	4.104	37	3.0
08	QPSK	0.732899	1.466	14400	4.4	231 @ 128 kbps	54.2	4.397	37	3.0
09	8-ARY	0.521173	1.564	15360	5.1	246 @ 128 kbps	93.8	4.691	60	3.0
10	8-ARY	0.537459	1.612	15840	5.4	254 @ 128 kbps	96.7	4.837	60	3.0
11	8-ARY	0.561889	1.686	16560	5.6	265 @ 128 kbps	101.1	5.057	60	3.0
12	8-ARY	0.586319	1.759	17280	5.8	276 @ 128 kbps	105.5	5.277	60	3.0
13	8-ARY	0.610749	1.832	18000	6.0	287 @ 128 kbps	109.9	5.497	60	3.0
14	8-ARY	0.635179	1.906	18720	6.2	299 @ 128 kbps	114.3	5.717	60	3.0
15	8-ARY	0.659609	1.979	19440	6.5	311 @ 128 kbps	118.7	5.936	60	3.0
16	8-ARY	0.684039	2.052	20160	6.9	322 @ 128 kbps	123.1	6.156	60	3.0
17	8-ARY	0.708469	2.125	20880	7.2	333 @ 128 kbps	127.5	6.376	60	3.0
18	8-ARY	0.732899	2.199	21600	7.5	173 @ 256 kbps	131.9	6.596	60	3.0
19	16-ARY	0.586319	2.345	23040	8.1	184 @ 256 kbps	234.5	7.036	100	3.0
20	16-ARY	0.610749	2.443	24000	8.6	192 @ 256 kbps	244.3	7.329	100	3.0
21	16-ARY	0.635179	2.541	24960	8.9	199 @ 256 kbps	254.1	7.622	100	3.0
22	16-ARY	0.659609	2.638	25920	9.2	104 @ 512 kbps	263.8	7.915	100	3.0
23	16-ARY	0.684039	2.736	26880	9.6	108 @ 512 kbps	273.6	8.208	100	3.0
24	16-ARY	0.708469	2.834	27840	10.0	111 @ 512 kbps	283.4	8.502	100	3.0
25	16-ARY	0.732899	2.932	28800	10.5	115 @ 512 kbps	293.2	8.795	100	3.0
26	16-ARY	0.757329	3.029	29760	10.9	119 @ 512 kbps	302.9	9.088	100	3.0
27	16-ARY	0.781759	3.127	30720	11.4	123 @ 512 kbps	312.7	9.381	100	3.0
28	32-ARY	0.659609	3.298	32400	12.0	65 @ 1 Mbps	824.5	9.894	250	3.0
29	32-ARY	0.684039	3.420	33600	12.5	67 @ 1 Mbps	855.0	10.239	250	3.0
30	32-ARY	0.708469	3.542	34800	12.9	70 @ 1 Mbps	885.6	10.239	250	2.9
31	32-ARY	0.732899	3.664	36000	13.3	72 @ 1 Mbps	916.1	10.239	250	2.8
32	32-ARY	0.757329	3.787	37200	13.7	74 @ 1 Mbps	946.7	10.239	250	2.7
33	32-ARY	0.781759	3.909	38400	14.2	77 @ 2 Mbps	977.2	10.239	250	2.6
34	32-ARY	0.801303	4.007	39360	14.7	39 @ 2 Mbps	1001.6	10.239	250	2.6
35	32-ARY	0.830619	4.153	40800	15.2	41 @ 2 Mbps	1038.3	10.239	250	2.5
36	32-ARY	0.855049	4.275	42000	16.0	42 @ 2 Mbps	1068.8	10.239	250	2.4
37	32-ARY	0.879479	4.397	43200	16.7	43 @ 2 Mbps	1099.3	10.239	250	2.3

**Table B-7. VersaFEC-2 ModCod Set – Short Block**

ModCod	Mod	Code Rate	Spectral Efficiency (bps/Hz)	Block Size (bits)	Typical * Es/No (SNR), for BER = $1 \times 10^{-8}$ (dB)	Latency (@ X Kbps/Mbps (ms))	Min. Data Rate, CCM Mode (kbps)	Max. Data Rate, CCM Mode (Mbps)	Min Sym Rate, ACM Mode (ksps)	Max Sym Rate, ACM Mode (Msps)
00	BPSK	0.489599	0.489	800	-0.2	16 @ 128 kbps	18.1	0.490	37	1.0
01	QPSK	0.489599	0.977	1600	2.3	30 @ 128 kbps	36.2	0.979	37	1.0
02	QPSK	0.537459	1.075	1760	2.8	33 @ 128 kbps	39.8	1.075	37	1.0
03	QPSK	0.586319	1.173	1920	3.4	36 @ 128 kbps	43.4	1.173	37	1.0
04	QPSK	0.610749	1.221	2000	3.7	37 @ 128 kbps	45.2	1.221	37	1.0
05	QPSK	0.635179	1.270	2080	3.9	38 @ 128 kbps	47.0	1.270	37	1.0
06	QPSK	0.659609	1.319	2160	4.2	39 @ 128 kbps	48.8	1.319	37	1.0
07	QPSK	0.684039	1.368	2240	4.5	41 @ 128 kbps	50.6	1.368	37	1.0
08	QPSK	0.732899	1.466	2400	5.2	43 @ 128 kbps	54.2	1.466	37	1.0
09	8-ARY	0.521173	1.564	2560	5.6	46 @ 128 kbps	93.8	1.564	60	1.0
10	8-ARY	0.537459	1.612	2640	5.9	47 @ 128 kbps	96.7	1.612	60	1.0
11	8-ARY	0.561889	1.686	2760	6.2	49 @ 128 kbps	101.1	1.686	60	1.0
12	8-ARY	0.586319	1.759	2880	6.4	51 @ 128 kbps	105.5	1.759	60	1.0
13	8-ARY	0.610749	1.832	3000	6.6	53 @ 128 kbps	109.9	1.832	60	1.0
14	8-ARY	0.635179	1.906	3120	6.9	55 @ 128 kbps	114.3	1.906	60	1.0
15	8-ARY	0.659609	1.979	3240	7.2	57 @ 128 kbps	118.7	1.979	60	1.0
16	8-ARY	0.684039	2.052	3360	7.5	59 @ 128 kbps	123.1	2.000	60	1.0
17	8-ARY	0.708469	2.125	3480	7.8	61 @ 128 kbps	127.5	2.000	60	0.9
18	8-ARY	0.732899	2.199	3600	8.3	32 @ 256 kbps	131.9	2.000	60	0.9
19	16-ARY	0.586319	2.345	3840	8.7	34 @ 256 kbps	234.5	2.000	100	0.9
20	16-ARY	0.610749	2.443	4000	9.0	35 @ 256 kbps	244.3	2.000	100	0.8
21	16-ARY	0.635179	2.541	4160	9.3	37 @ 256 kbps	254.1	2.000	100	0.8
22	16-ARY	0.659609	2.638	4320	9.7	19 @ 512 kbps	263.8	2.000	100	0.8
23	16-ARY	0.684039	2.736	4480	10.3	20 @ 512 kbps	273.6	2.000	100	0.7
24	16-ARY	0.708469	2.834	4640	10.7	21 @ 512 kbps	283.4	2.000	100	0.7
25	16-ARY	0.732899	2.932	4800	11.0	22 @ 512 kbps	293.2	2.000	100	0.7
26	16-ARY	0.757329	3.029	4960	11.6	22 @ 512 kbps	302.9	2.000	100	0.7
27	16-ARY	0.781759	3.127	5120	12.2	23 @ 512 kbps	312.7	2.000	100	0.6
28	32-ARY	0.659609	3.298	5400	12.8	12 @ 1 Mbps	824.5	2.000	250	0.6
29	32-ARY	0.684039	3.420	5600	13.1	12 @ 1 Mbps	855.0	2.000	250	0.6
30	32-ARY	0.708469	3.542	5800	13.4	13 @ 1 Mbps	885.6	2.000	250	0.6
31	32-ARY	0.732899	3.664	6000	14.0	13 @ 1 Mbps	916.1	2.000	250	0.5
32	32-ARY	0.757329	3.787	6200	14.4	14 @ 1 Mbps	946.7	2.000	250	0.5
33	32-ARY	0.781759	3.909	6400	14.8	14 @ 1 Mbps	977.2	2.000	250	0.5
34	32-ARY	0.801303	4.007	6560	15.2	7 @ 2 Mbps	1001.6	2.000	250	0.5
35	32-ARY	0.830619	4.153	6800	15.8	7 @ 2 Mbps	1038.3	2.000	250	0.5

**Notes:**

- \*Typical Es/Lo values are shown – guaranteed values are 0.3 dB higher.
- Es/No (SNR) is used in place of Eb/No, a convention for comparing ACM ModCods. SNR is defined as:  $E_s/N_0 = E_b/N_0 + 10 * 10_{\log}(\text{Spectral Efficiency})$

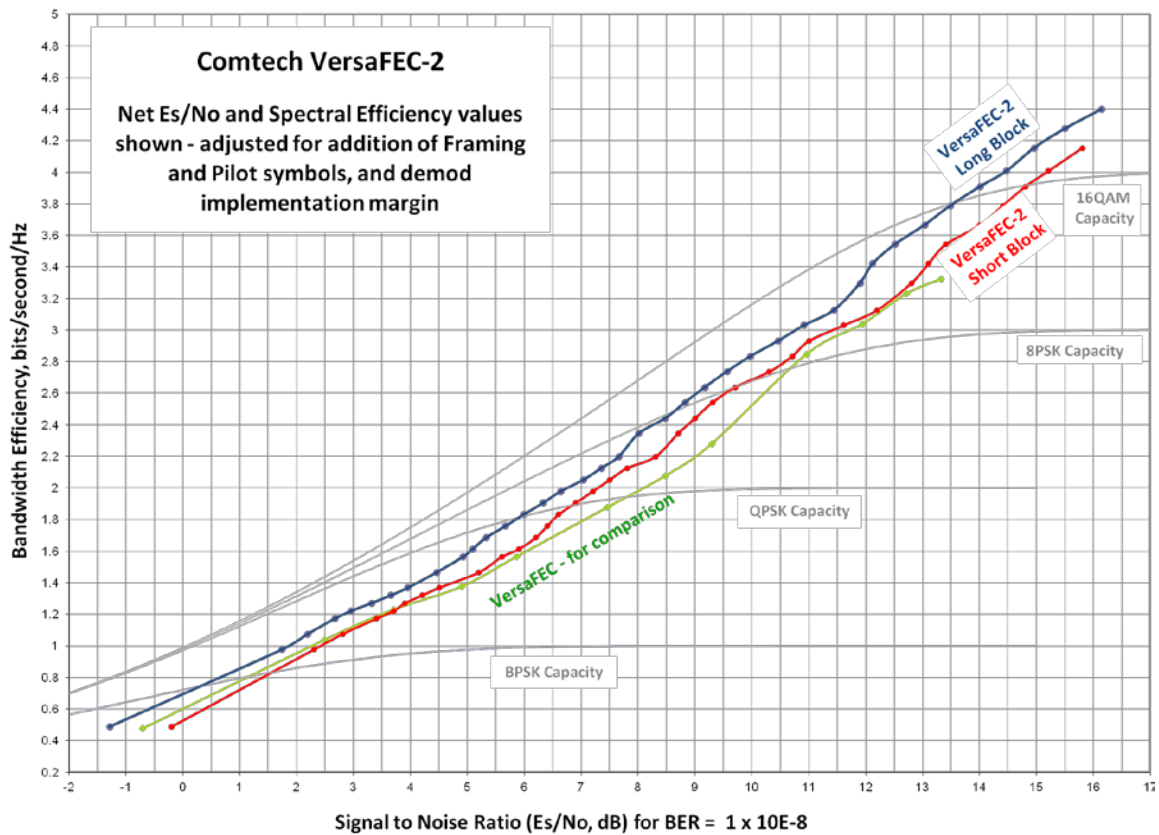

Figure B-2. VersaFEC-2 Codes vs. Constrained Capacity (Typical Values Shown)

BLANK PAGE

## B.7.1 Field Upgrade Procedure – VersaFEC-2 Option Card

---

### B.7.1.1 Overview

This section describes the field upgrade procedure you will need to follow to retrofit your CDM-570A/570AL with the optional VersaFEC-2 Option Card.

---

### B.7.1.2 Requirements for Field Upgrade

- CDM-570A/570AL Satellite Modem
- Medium Phillips™ screwdriver
- CEFD P/N KT-0021134 VersaFEC-2 Option Card, containing:

CEFD Part Number	QTY	Description
PL-0022376	1	CDM-570A/570AL VersaFEC-2 Option Card
HW/SEM440X1/4PH	1	Screw, S.S., 4-40 x 1/4 LG, Pan Head Phillips

### B.7.1.3 Field Upgrade Procedure



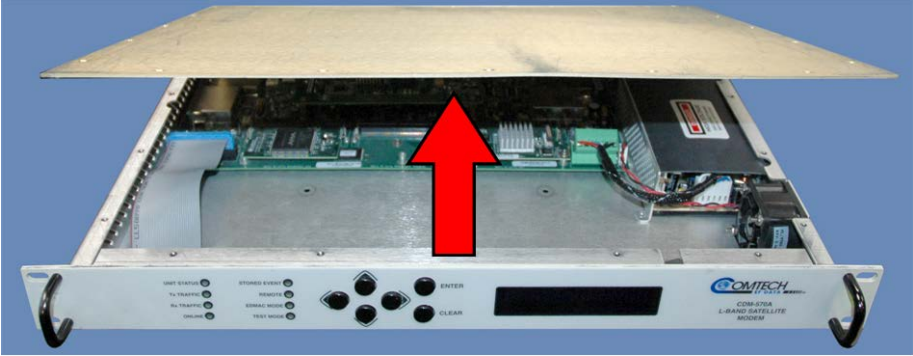

**CAUTION** – Obey precautions for handling electrostatic-sensitive devices.

Step	Task
1	<p>Turn off the CDM-570A/570AL and disconnect the modem's power cord from its power source.</p> <p>Next, use the screwdriver to remove all of the top cover mounting hardware (18 screws on top).</p> <p>Remove the cover from the CDM-570A/570AL chassis.</p> <p><b>IMPORTANT:</b> Be sure to retain the top cover mounting hardware for cover re-installation once you have installed the VersaFEC-2 Field Upgrade Kit.</p> 

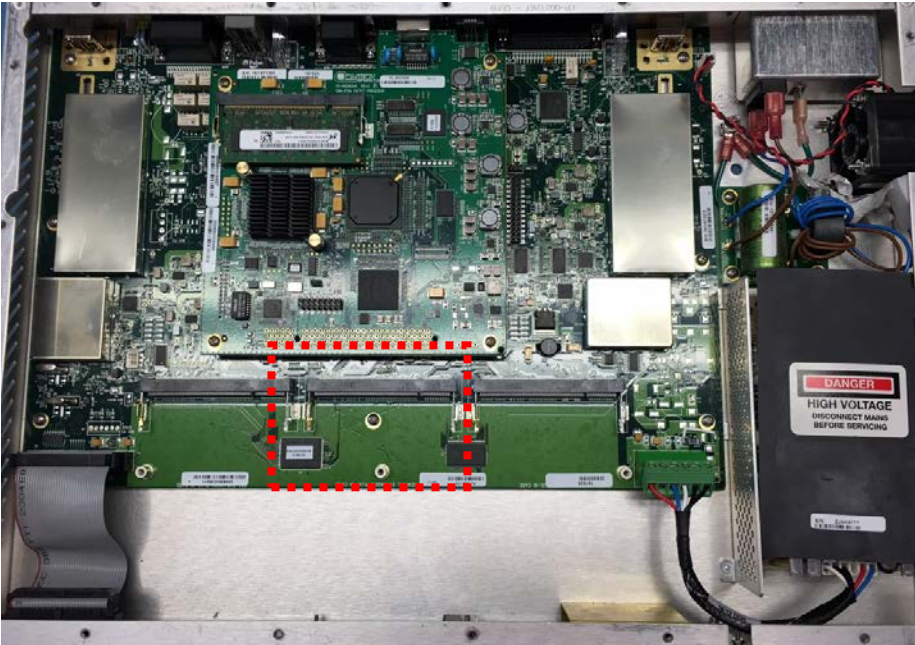
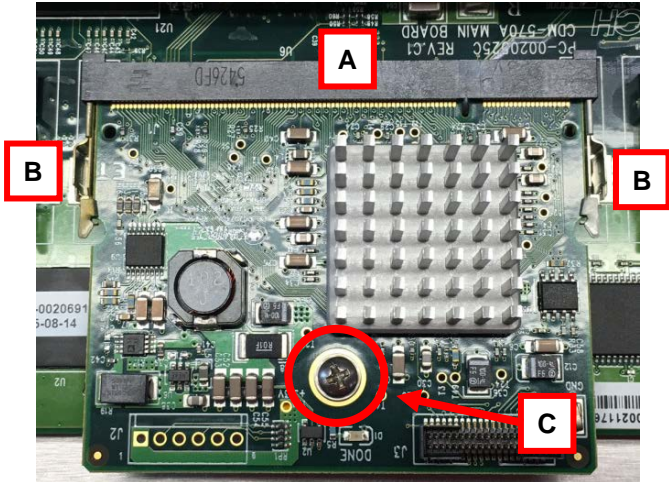

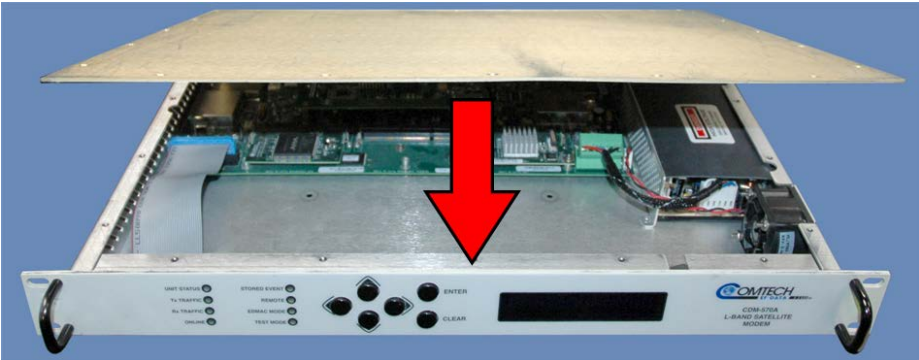
Step	Task	
2	Align the VerseFEC-2 Option Card connector with the middle slot located on the modem board.	
3	<p>(A) Plug the card firmly into the receptacle – take care not to damage any top-mounted components. Similarly, be sure not to damage the bottom of the card during this task.</p> <p>(B) Snap the spring-loaded capture tabs into place. They are located at both sides of the card.</p> <p>(C) Use the screwdriver to secure the provided card mounting screw (CEFD P/N HW/SEM4-40X1/4PH) to its mating mounting boss.</p>	

Step	Task																					
4	<p>Use the screwdriver to reinstall the top cover onto the CDM-570A/570AL chassis with its existing mounting hardware.</p> <p>Plug the modem's power cord back into its power source.</p> 																					
5	<p>The CDM-570A/570AL VersaFEC-2 Option Card upgrade is now complete. You may turn on and resume use of the modem.</p> <p>Before continuing, it is important that you make sure you are running the latest available firmware, and that you have activated the necessary VersaFEC-2 FAST options. See Step 6 below.</p> <p> <b>NOTE:</b> The modem must have firmware version 1.5.2 or greater installed in both slots to use the VersaFEC-2 option.</p>																					
6	<p> • <b>Chapter 4. UPDATING FIRMWARE</b></p> <p>Follow the steps below to make sure the CDM-570A/570AL has both slots upgraded correctly with Firmware version 1.5.2.</p> <table border="1"> <thead> <tr> <th>Required Action</th> <th>Base Modem Slot 1 FW Version</th> <th>Base Modem Slot 2 FW Version</th> </tr> </thead> <tbody> <tr> <td>a. Initial Setup.</td> <td>1.4.3 (Running)</td> <td>1.4.3</td> </tr> <tr> <td>b. <b>Upgrade</b> alternate Slot 2 to firmware version 1.5.2.</td> <td>1.4.3 (Running)</td> <td>1.5.2</td> </tr> <tr> <td>c. Select <b>Base to Boot</b> from Slot 2.</td> <td>1.4.3</td> <td>1.5.2 (Running)</td> </tr> <tr> <td>d. <b>Upgrade</b> alternate Slot 1 to firmware version 1.5.2.</td> <td>1.5.2</td> <td>1.5.2 (Running)</td> </tr> <tr> <td>e. Select <b>Base to Boot</b> from Slot 1.</td> <td>1.5.2 (Running)</td> <td>1.5.2</td> </tr> <tr> <td>f. <b>Upgrade</b> to alternate Slot 2.</td> <td>1.5.2 (Running)</td> <td>1.5.2 (Overwritten)</td> </tr> </tbody> </table>	Required Action	Base Modem Slot 1 FW Version	Base Modem Slot 2 FW Version	a. Initial Setup.	1.4.3 (Running)	1.4.3	b. <b>Upgrade</b> alternate Slot 2 to firmware version 1.5.2.	1.4.3 (Running)	1.5.2	c. Select <b>Base to Boot</b> from Slot 2.	1.4.3	1.5.2 (Running)	d. <b>Upgrade</b> alternate Slot 1 to firmware version 1.5.2.	1.5.2	1.5.2 (Running)	e. Select <b>Base to Boot</b> from Slot 1.	1.5.2 (Running)	1.5.2	f. <b>Upgrade</b> to alternate Slot 2.	1.5.2 (Running)	1.5.2 (Overwritten)
Required Action	Base Modem Slot 1 FW Version	Base Modem Slot 2 FW Version																				
a. Initial Setup.	1.4.3 (Running)	1.4.3																				
b. <b>Upgrade</b> alternate Slot 2 to firmware version 1.5.2.	1.4.3 (Running)	1.5.2																				
c. Select <b>Base to Boot</b> from Slot 2.	1.4.3	1.5.2 (Running)																				
d. <b>Upgrade</b> alternate Slot 1 to firmware version 1.5.2.	1.5.2	1.5.2 (Running)																				
e. Select <b>Base to Boot</b> from Slot 1.	1.5.2 (Running)	1.5.2																				
f. <b>Upgrade</b> to alternate Slot 2.	1.5.2 (Running)	1.5.2 (Overwritten)																				

---

## B.8 Uncoded Operation (No FEC)



**CAUTION** – Comtech EF Data strongly cautions users when using uncoded operation. If the acquisition sweep width exceeds one quarter of the symbol rate, there is a very high probability that the demodulator will false lock.

**Example:** If selecting 64 kbps QPSK, uncoded, the symbol rate will be half of this rate, or 32 ksymbols/second. One quarter of this equals 8 kHz. Therefore, the absolute maximum acquisition sweep range that should be considered is  $\pm 8$  kHz. If there is any frequency uncertainty on the incoming carrier, this should be subtracted from the sweep width. The problem becomes progressively better with increasing symbol rate.

**Comtech EF Data cannot be held responsible for incorrect operation if the user does not adhere to these guidelines when using uncoded operation.**

There are occasions where a user may wish to operate a satellite link with no forward error correction of any kind. For this reason, the CDM-570A/570AL offers this uncoded mode for three modulation types – BPSK, QPSK, and OQPSK. However, the user should be aware of some of the implications of using this approach.

PSK demodulators have two inherent undesirable features. The first, known as ‘phase ambiguity’, is due to the fact the demodulator does not have any absolute phase reference and, in the process of carrier recovery, the demodulator can lock up in any of  $K$  phase states where  $K = 2$  for BPSK,  $K = 4$  for QPSK. Without the ability to resolve these ambiguous states, there would be a 1-in-2 chance that the data at the output of the demodulator would be wrong in the case of BPSK. For QPSK, the probability would be 3-in-4.

The problem is solved in the case of BPSK by differentially encoding the data prior to transmission, then performing the inverse decoding process. This is a very simple process, but has the disadvantage that it doubles the receive BER. For every bit error the demodulator produces, the differential decoder produces two.

The problem for QPSK is more complex, as there are four possible lock states leading to four ambiguities. When FEC is employed, the lock state of the FEC decoder can be used to resolve two of the four ambiguities, and the remaining two can be resolved using serial differential encoding/decoding. However, when no FEC is being used, an entirely different scheme must be used. Therefore, in QPSK, a parallel differential encoding/decoding technique is used, but has the disadvantage that it again doubles the receive BER.

OQPSK is a different situation again, where the ambiguities result not only from not having an absolute phase reference, but also not knowing which of the two parallel paths in the demod, I or Q, contains the half-symbol delay. Another type of differential encoding is used, but yet again the error rate is doubled, compared to ideal.

**NOTE:** Whenever uncoded operation is selected, the modem offers the choice between enabling and disabling the differential encoder/decoder appropriate for the modulation type.

The second problem inherent in PSK demodulators is that of ‘data false locking’. In order to accomplish the task of carrier recovery, the demodulator must use a non-linear process. A second-order non-linearity is used for BPSK, and a fourth-order non-linearity is used for QPSK. When data at a certain symbol rate is used to modulate the carrier, the demodulator can lock at incorrect frequencies, spaced at intervals of one-quarter of the symbol rate away from the carrier. Fortunately, when FEC decoding is used, the decoder synchronization state can be used to verify the correct lock point has been achieved, and to reject the false locks.

However, if uncoded operation is used, there is no way to recognize a data false lock. The demodulator will indicate that it is correctly locked, but the data out will not be correct.

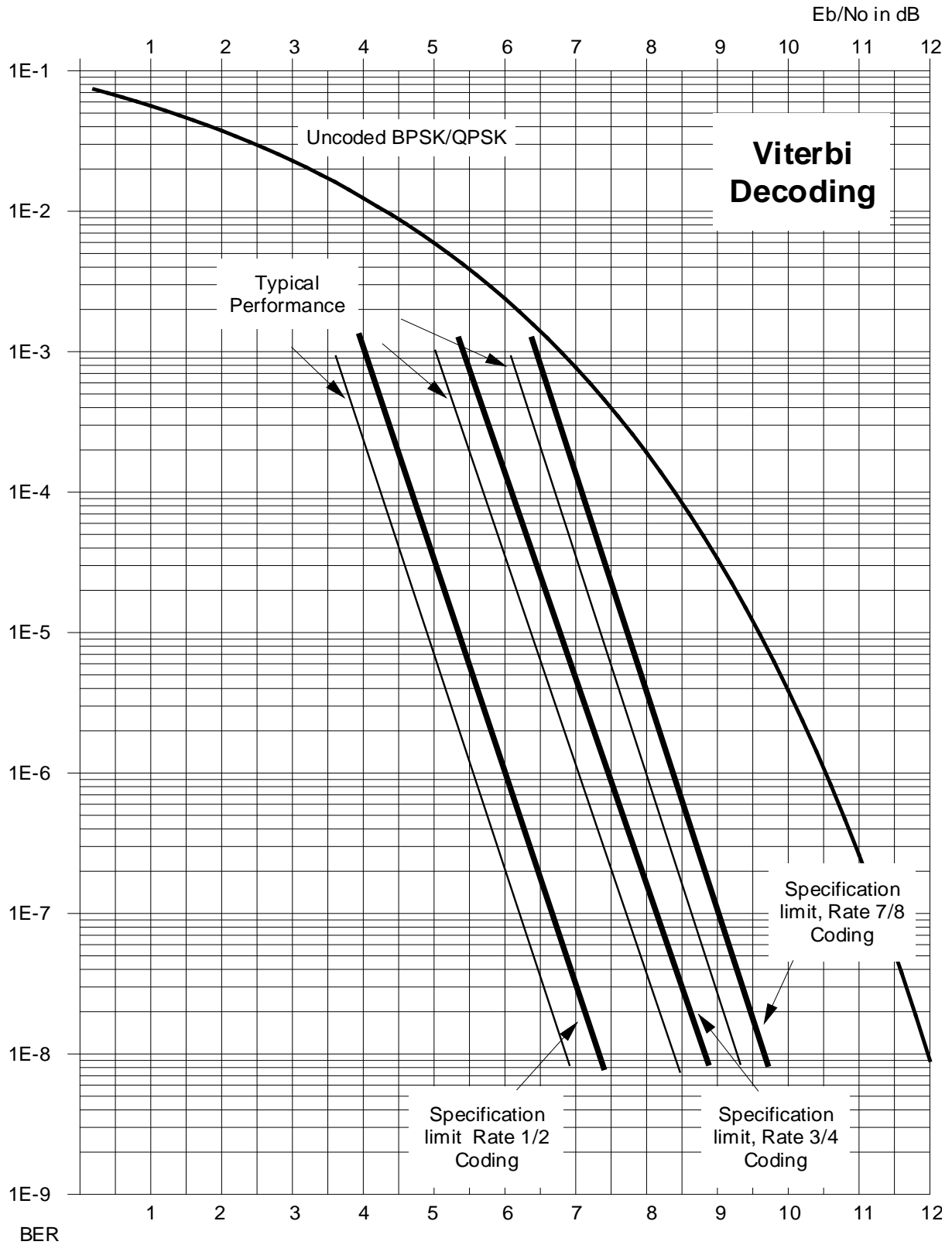

Figure B-3. Viterbi Decoding

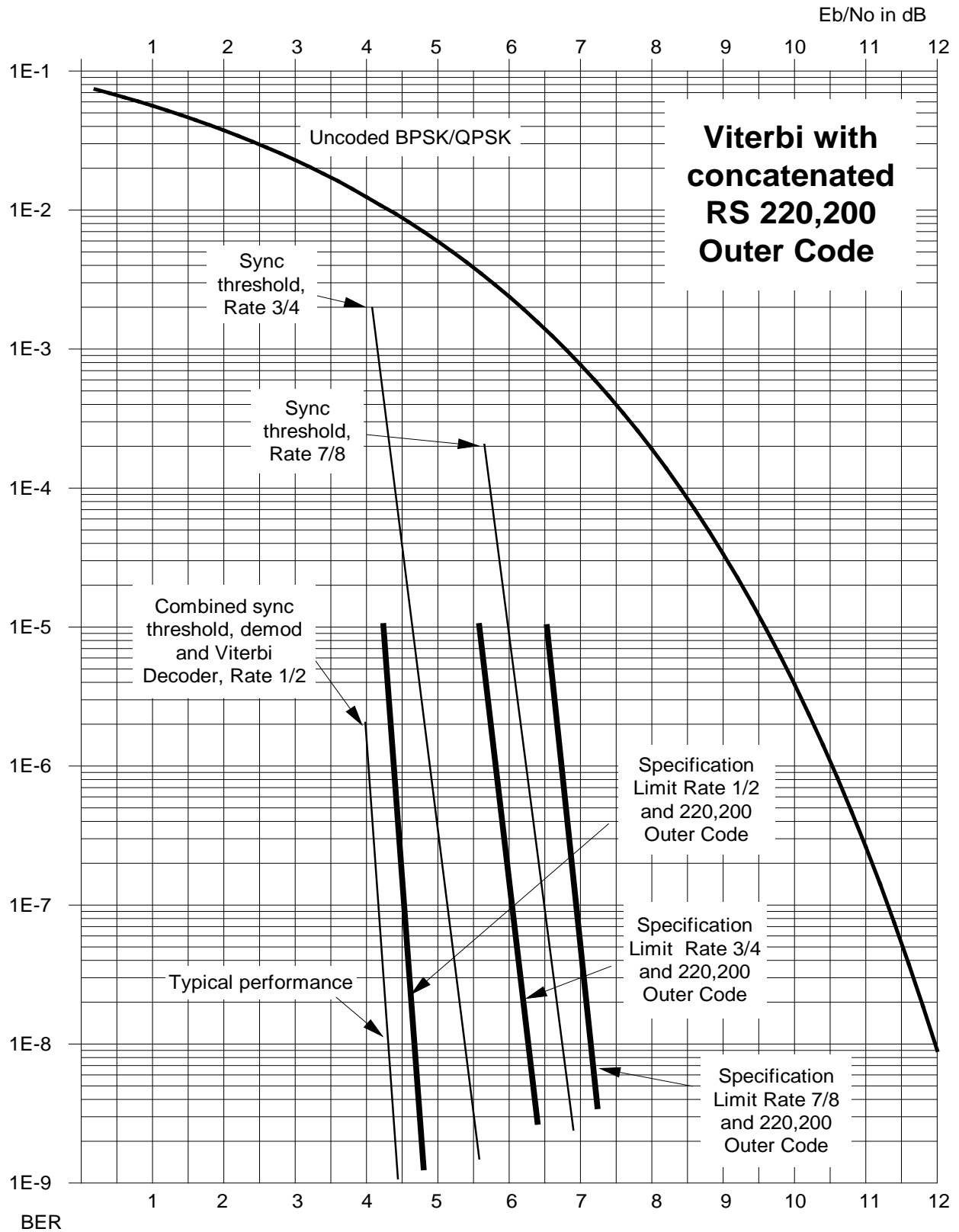

Figure B-4. Viterbi with Concatenated RS 220, 200 Outer Code

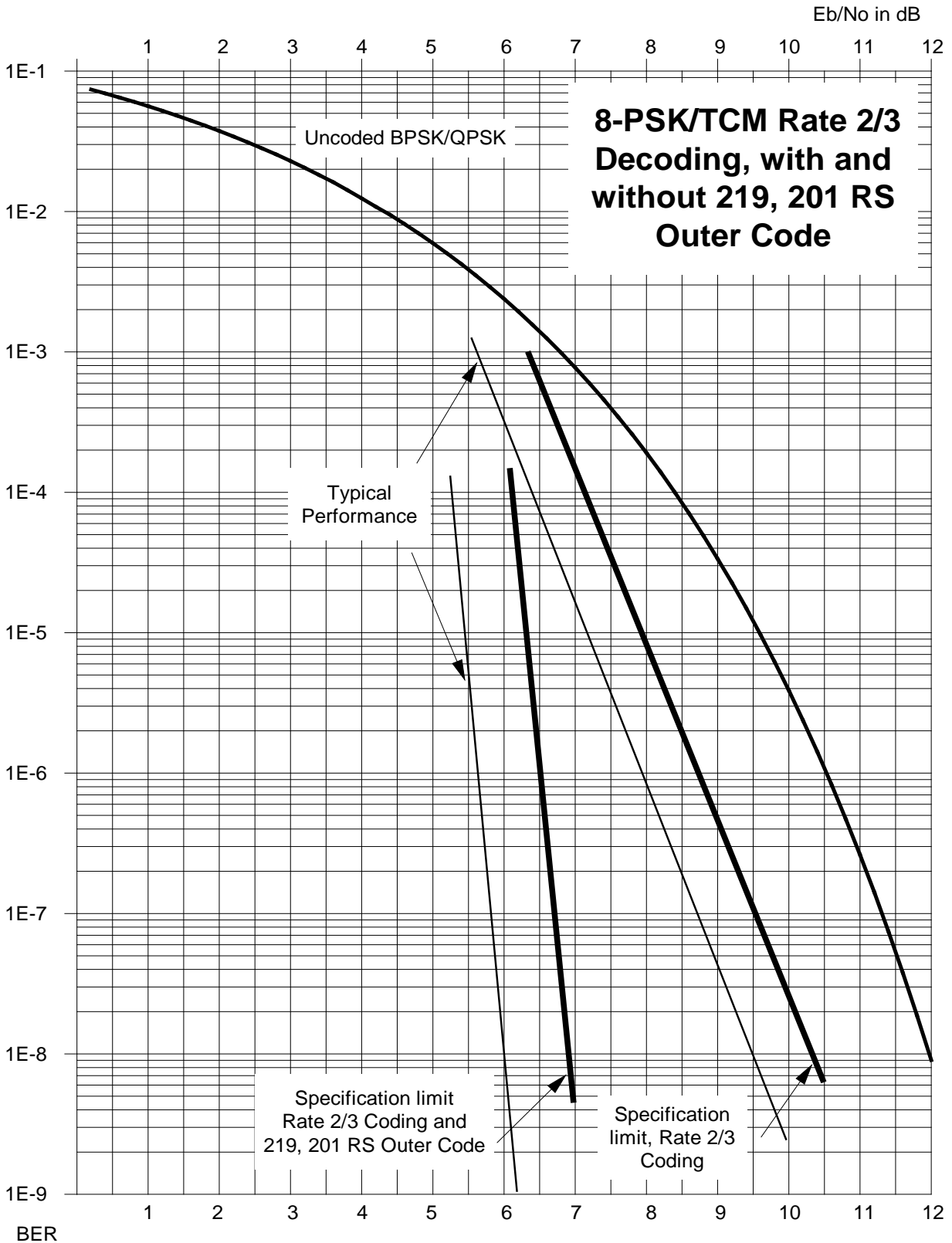
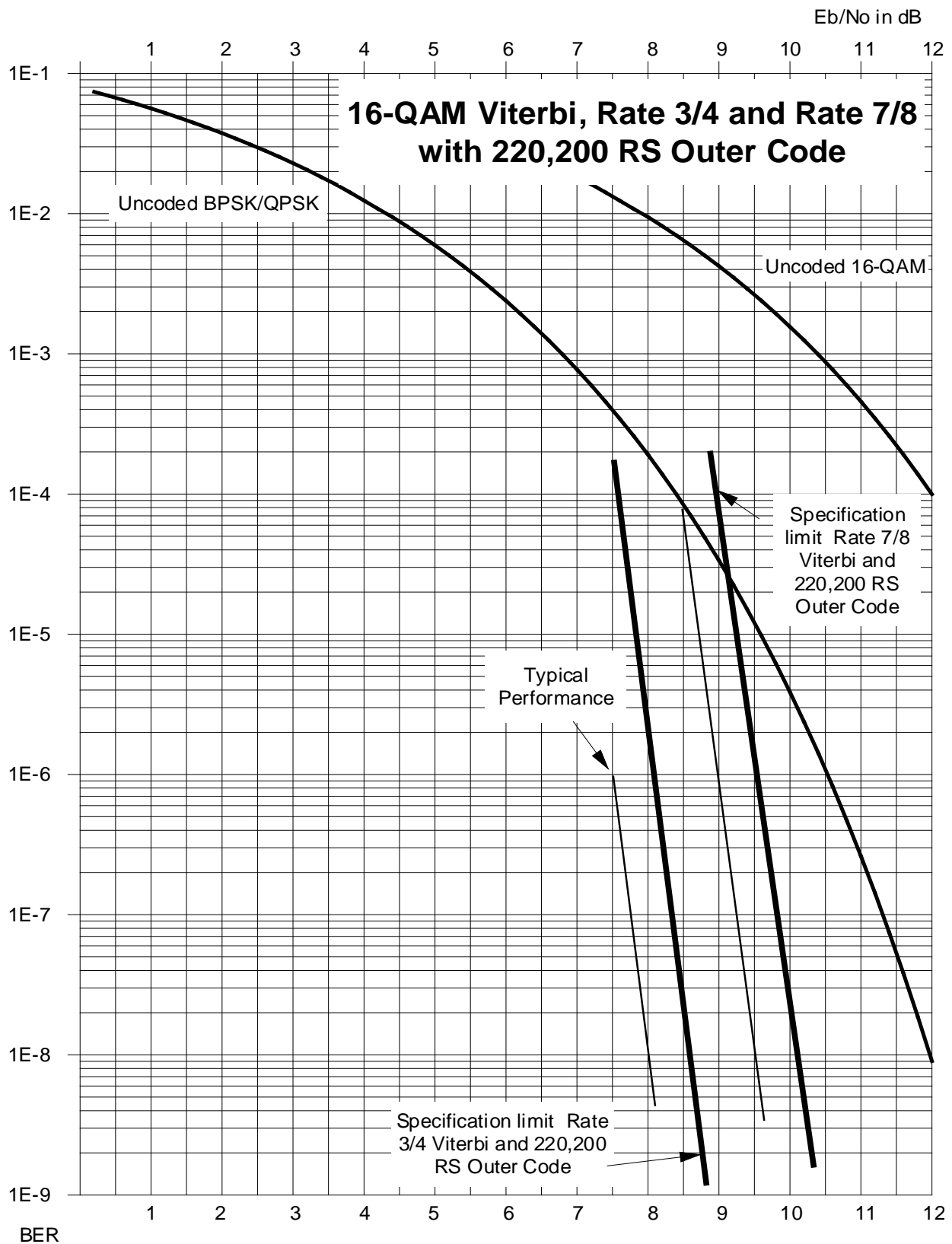

Figure B-5. 8-PSK/TCM Rate 2/3 Decoding with/without Concatenated RS 219, 201 Outer Code



**Figure B-6. 16-QAM Rates 3/4 and 7/8 with Concatenated RS 220,200 Outer Code**



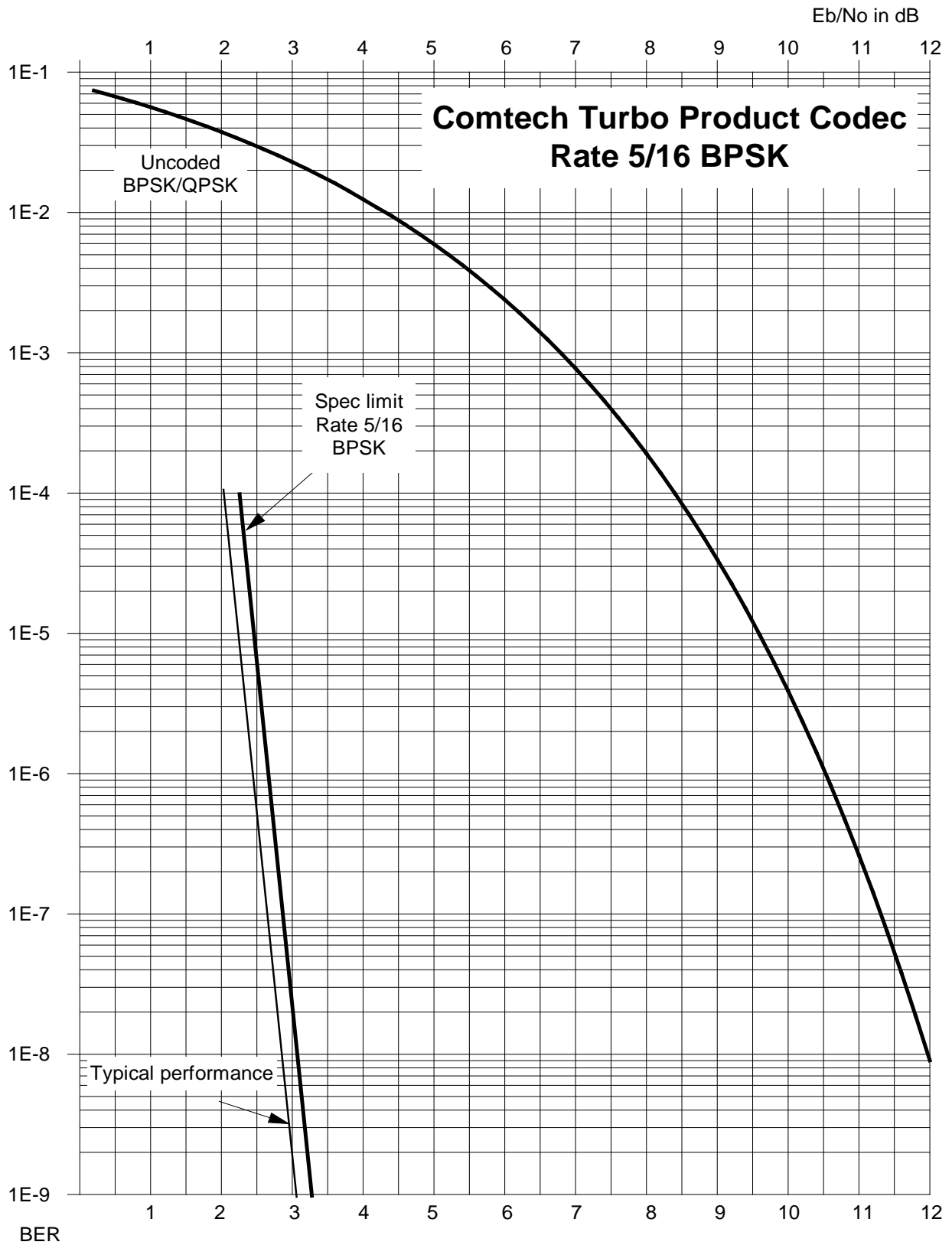
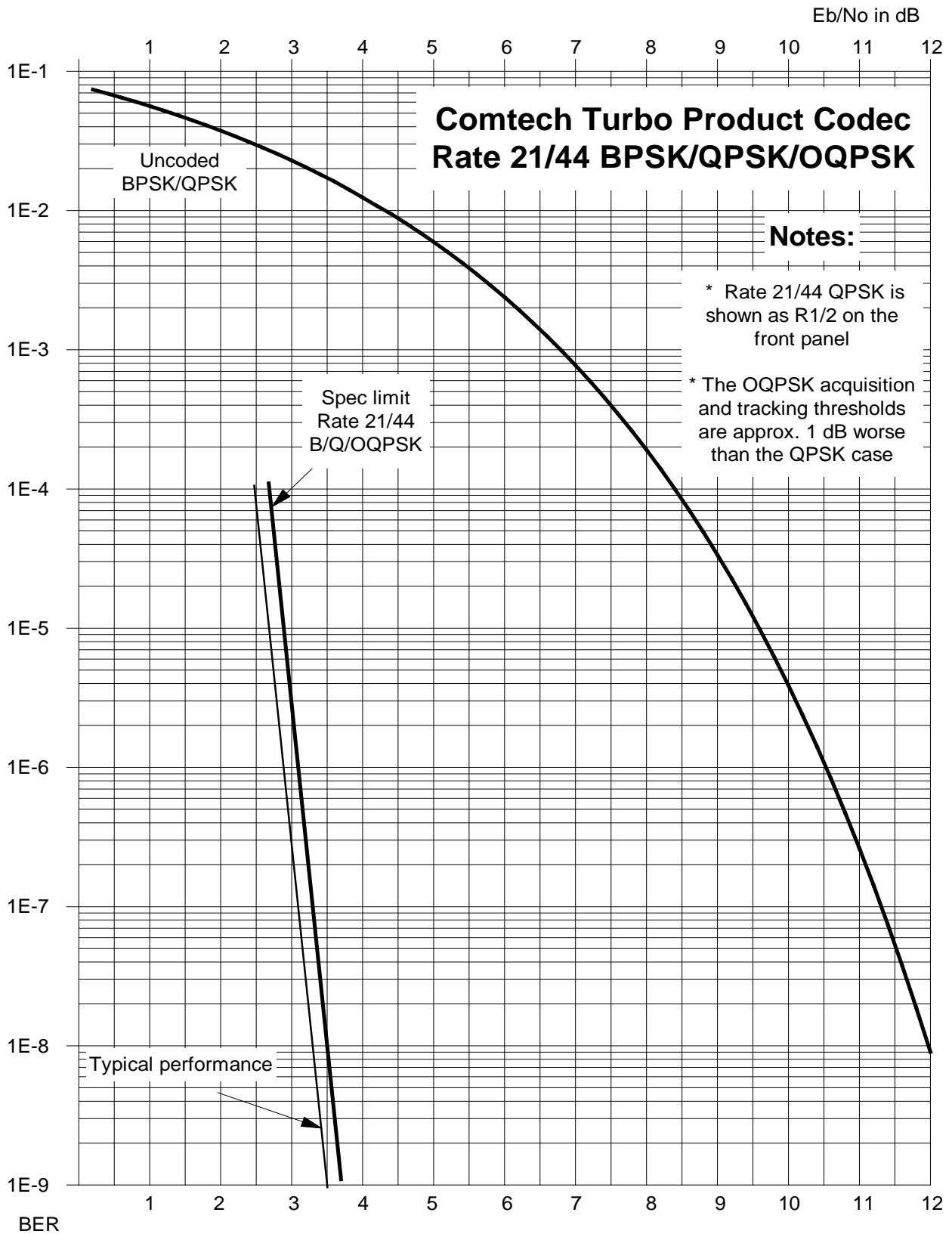

Figure B-7. Turbo Product Code Rate 5/16 BPSK



**Figure B-8. Turbo Product Codec Rate 21/44 BPSK/QPSK/OQPSK**

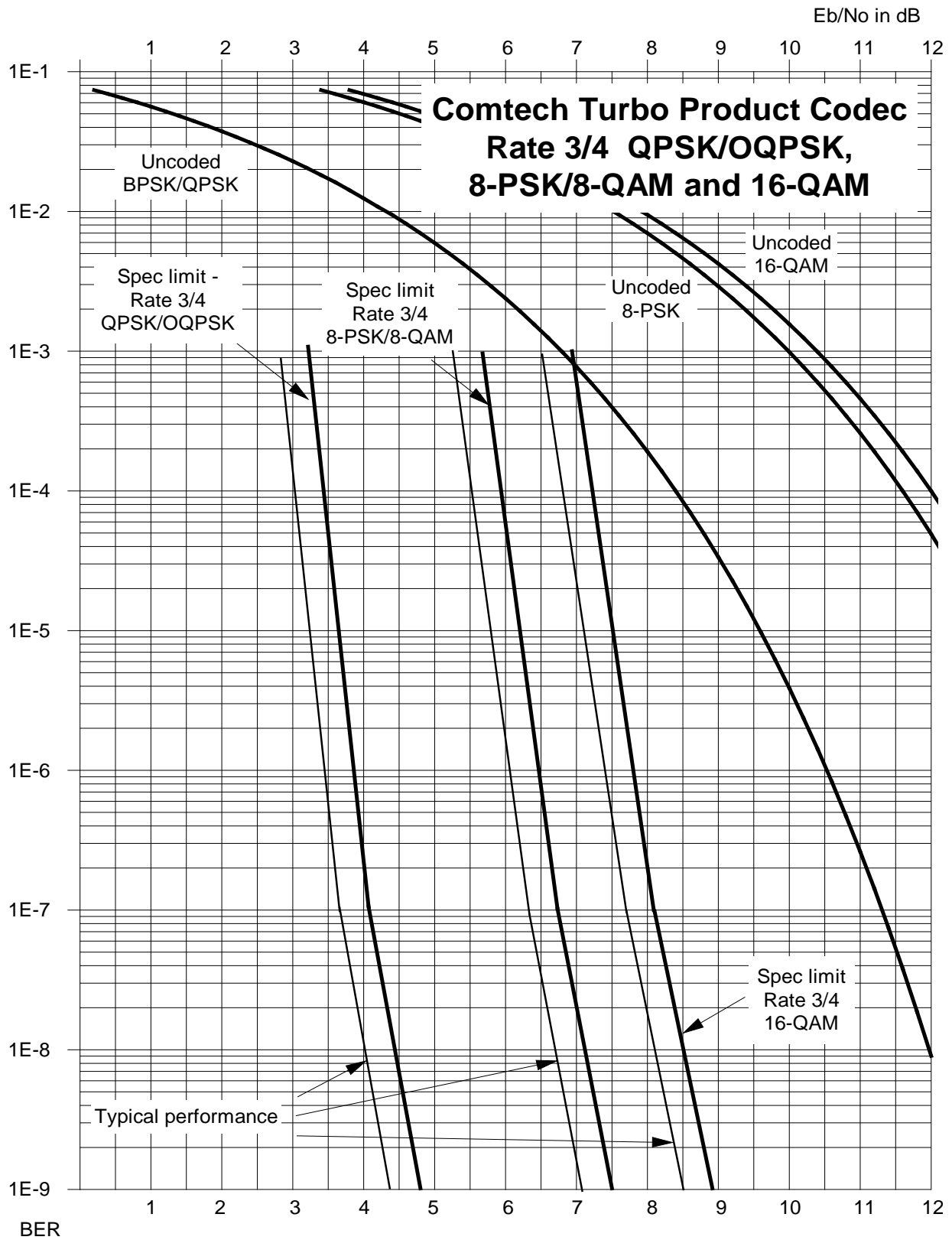

Figure B-9. Turbo Product Codec Rate 3/4 QPSK/OQPSK, 8-PSK/8-QAM, and 16-QAM

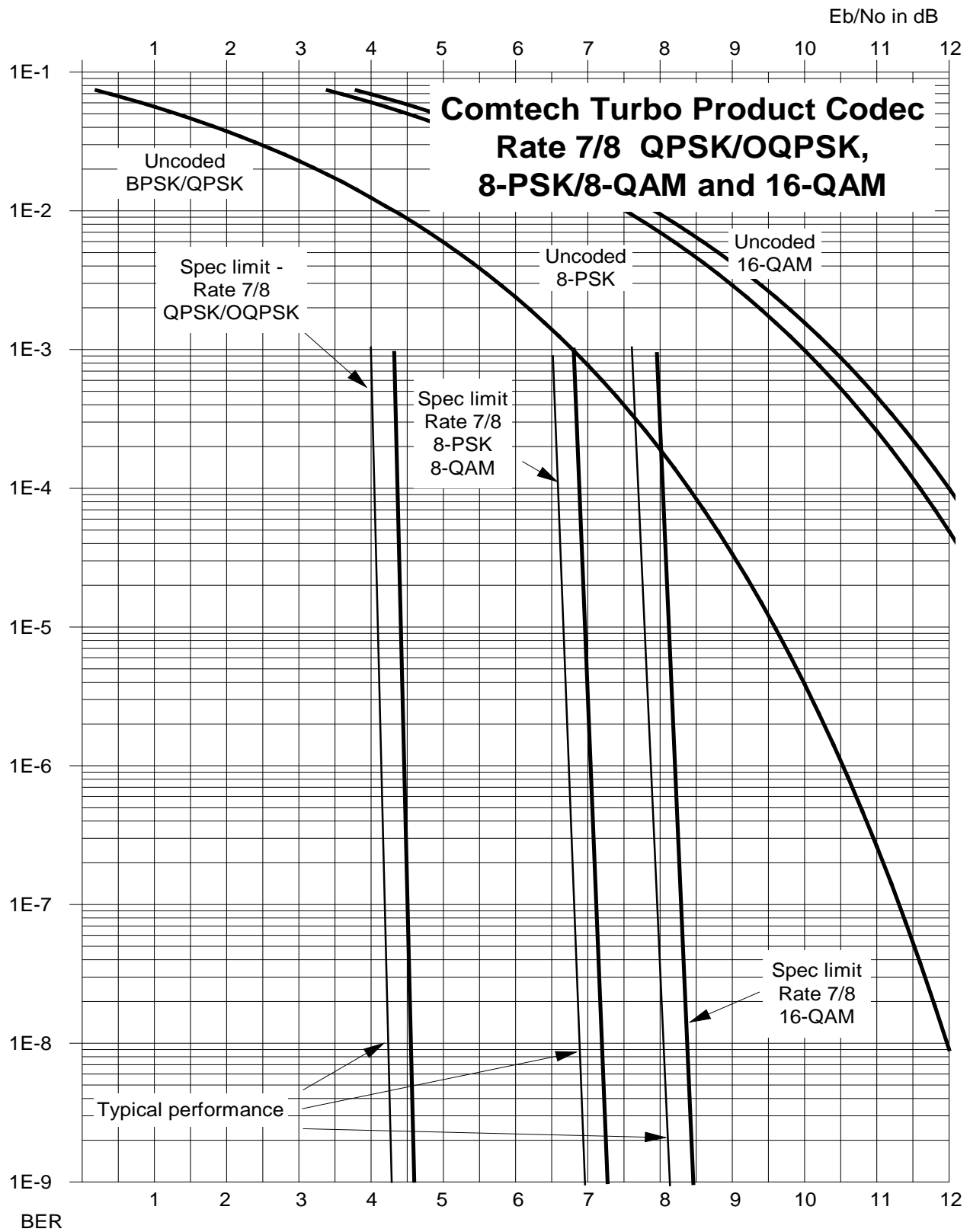

Figure B-10. Turbo Product Codec Rate 7/8 QPSK/OQPSK, 8-PSK/8-QAM, and 16-QAM

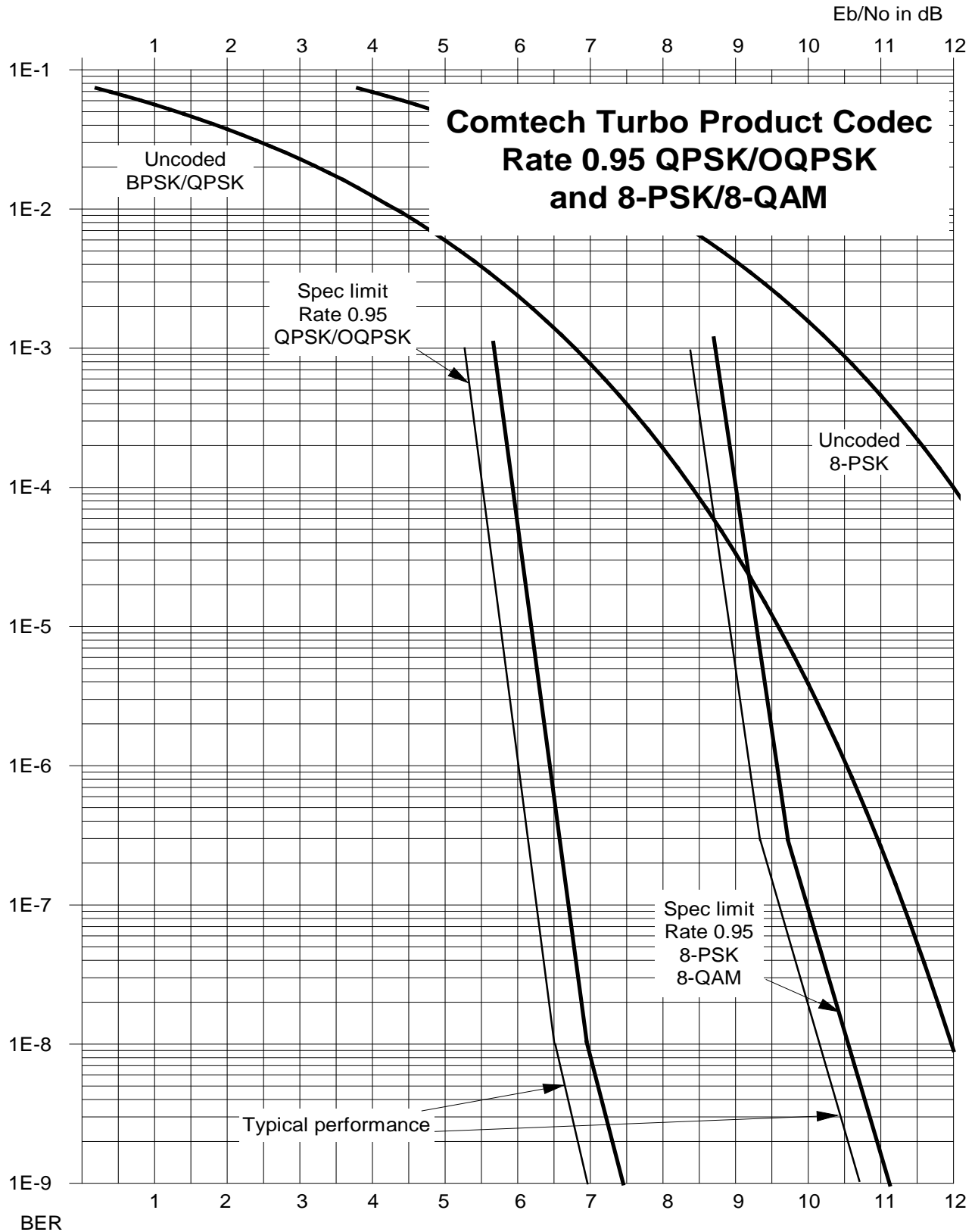

Figure B-11. Turbo Product Codec Rate 0.95 QPSK/OQPSK and 8-PSK/Q-QAM

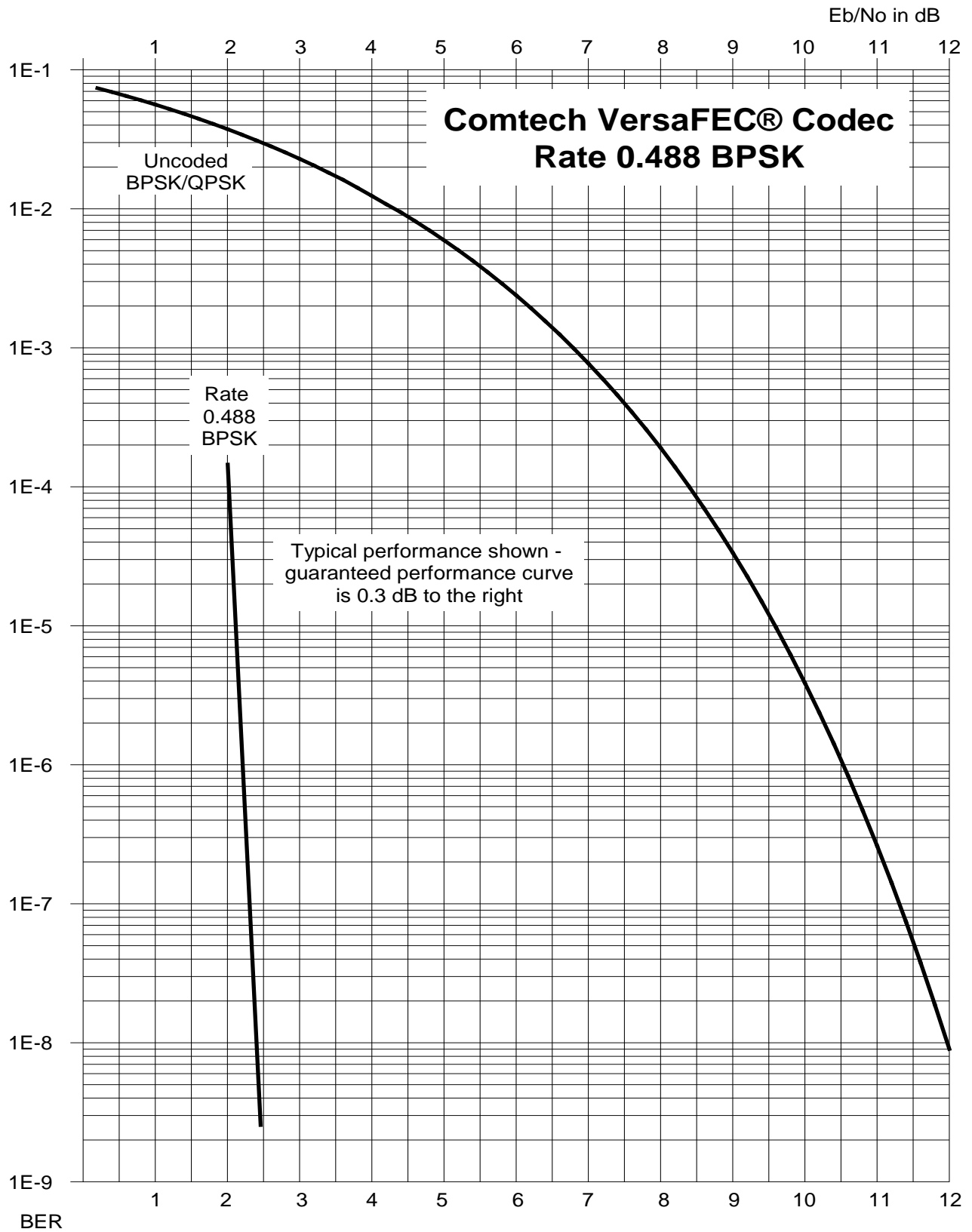

Figure B-12. VersaFEC Codec Rate 0.488 BPSK

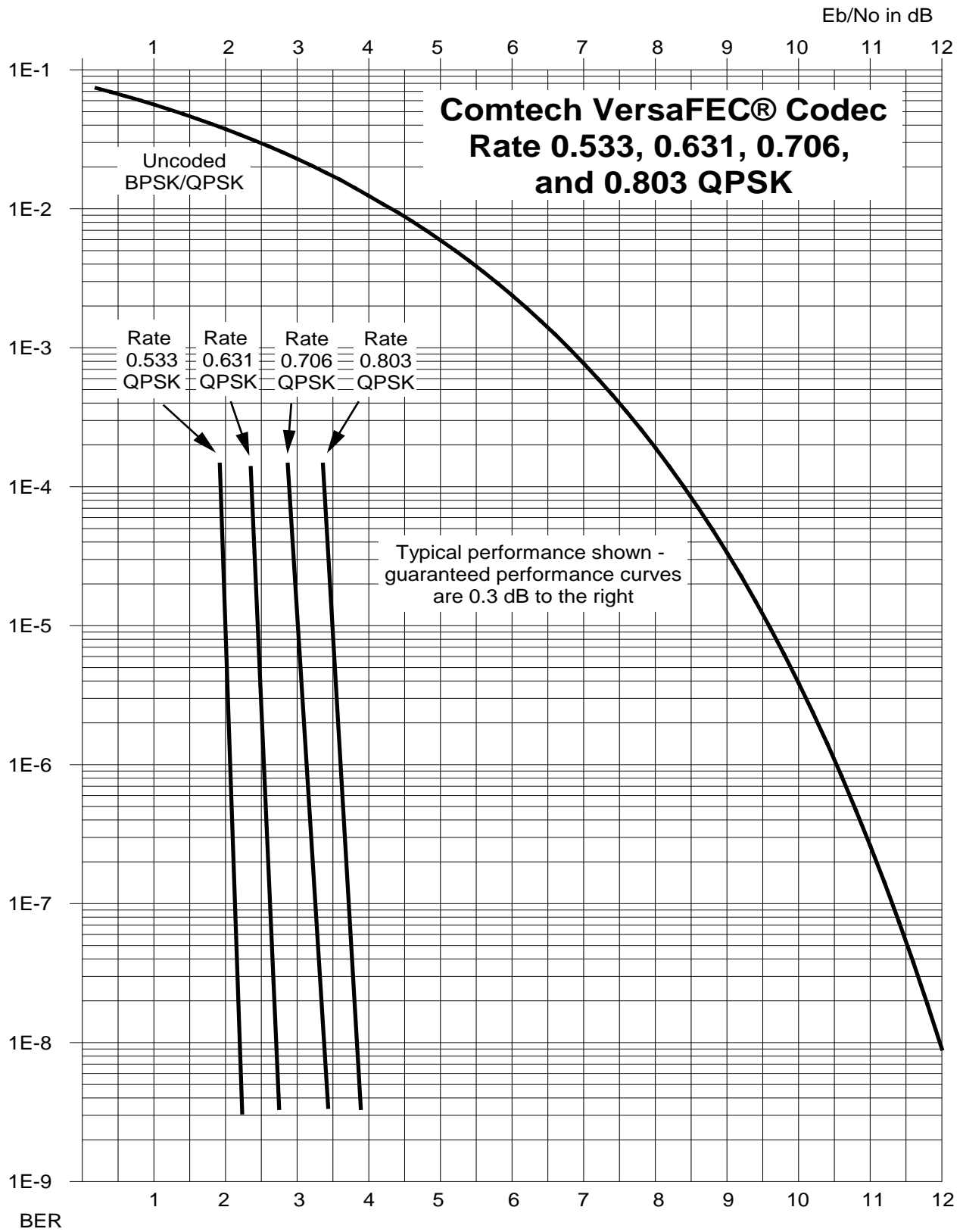

Figure B-13. VersaFEC Codec Rates 0.533, 0.631, 0.706, and 0.803 QPSK

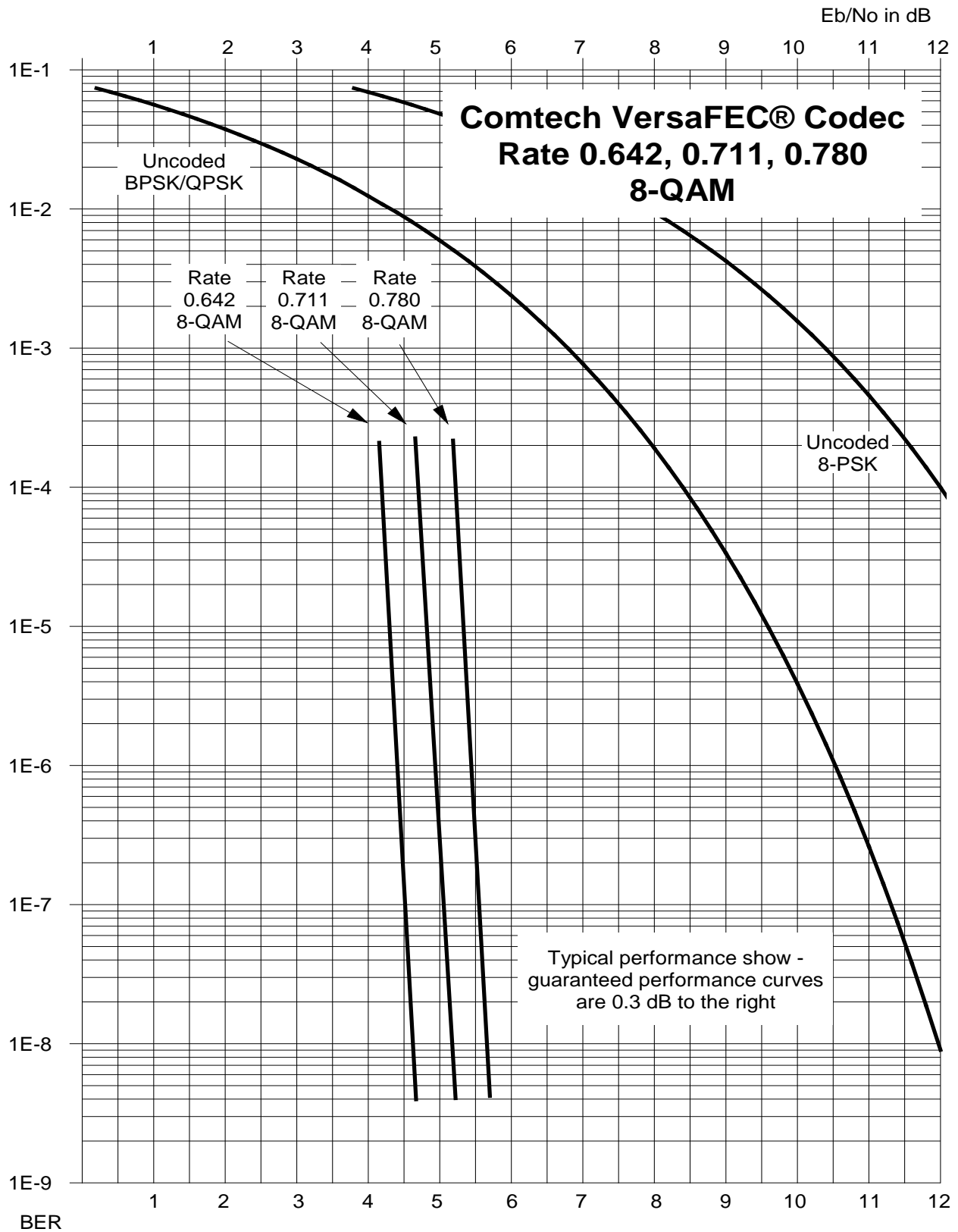

Figure B-14. VersaFEC Codec Rates 0.642, 0.711, and 0.780 8-QAM



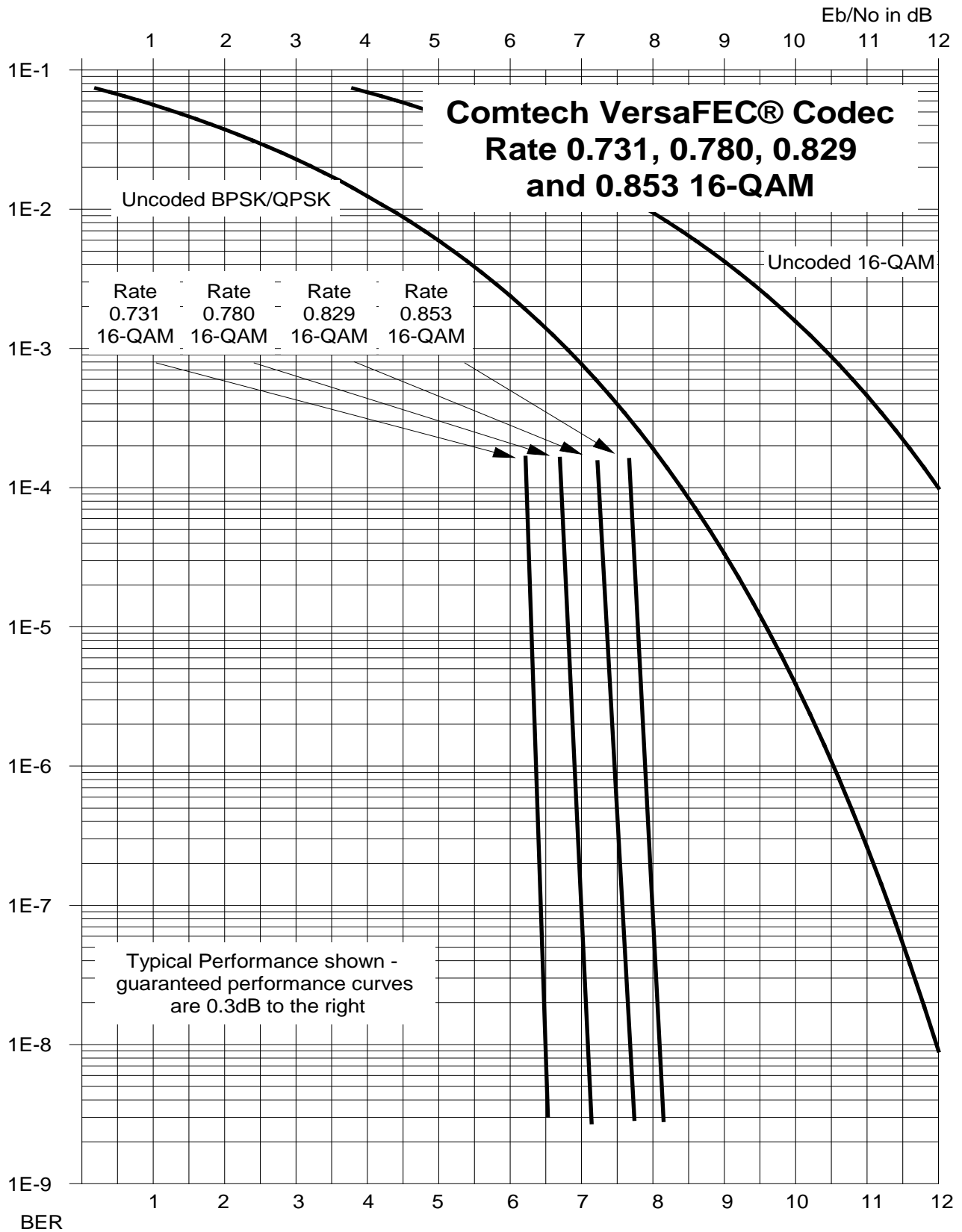

Figure B-15. VersaFEC Codec Rates 0.731, 0.780, 0.829, and 0.853 16-QAM

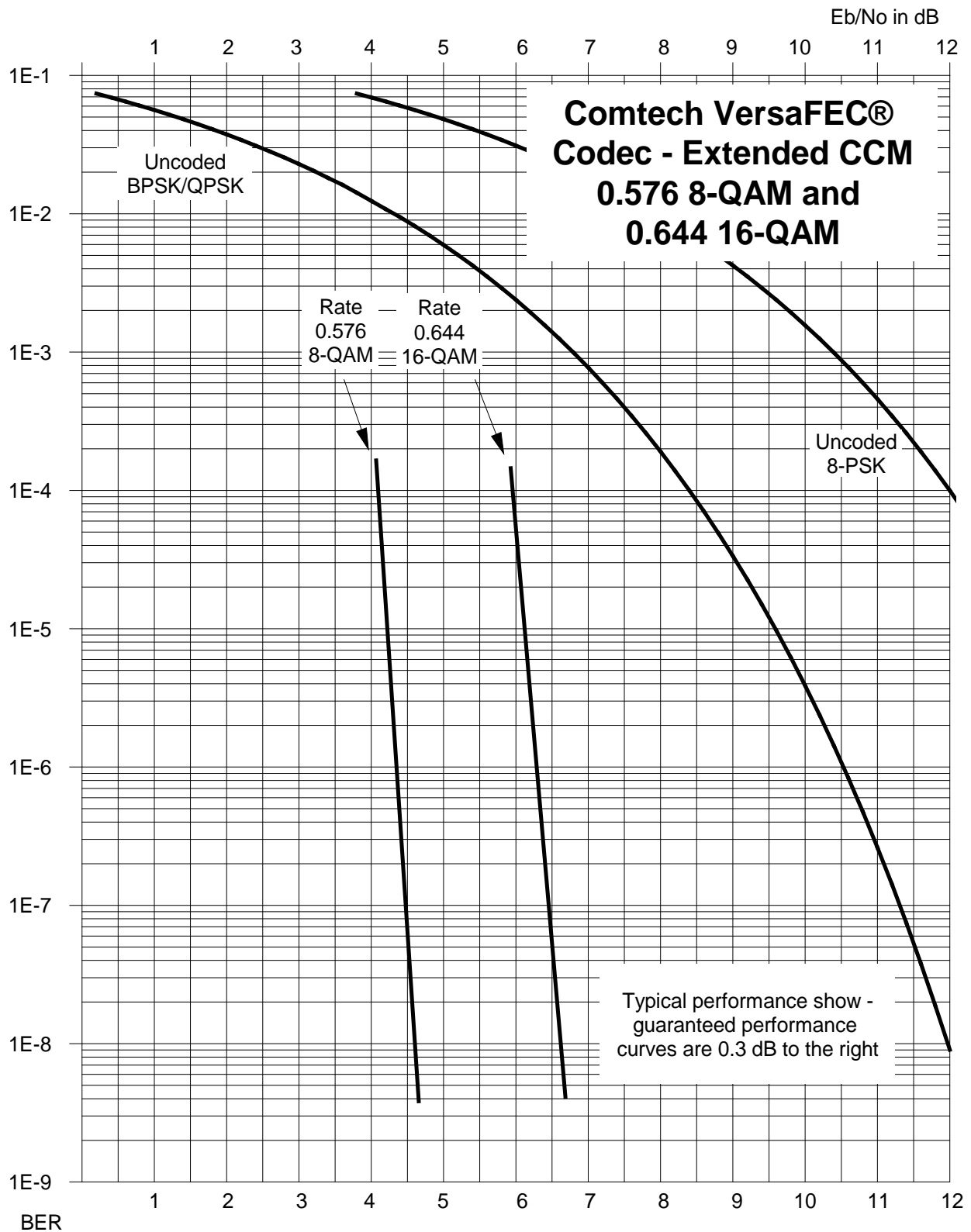

Figure B-16. VersaFEC Codec Extended CCM Rate 0.576 8-QAM and Rate 0.644 16-QAM

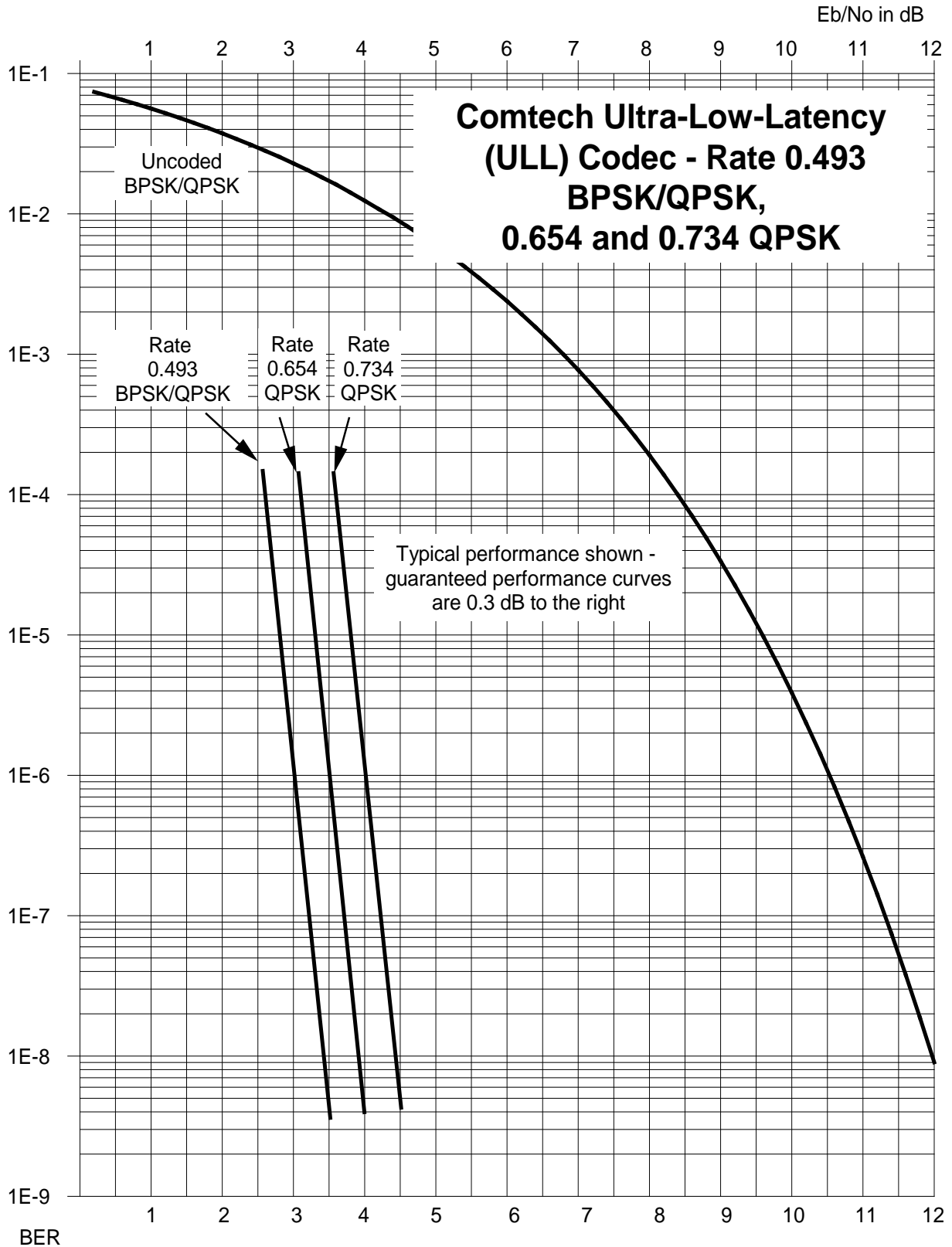

Figure B-17. ULL Codec Rate 0.493 BPSK/QPSK and Rates 0.654 and 0.734 QPSK

BLANK PAGE

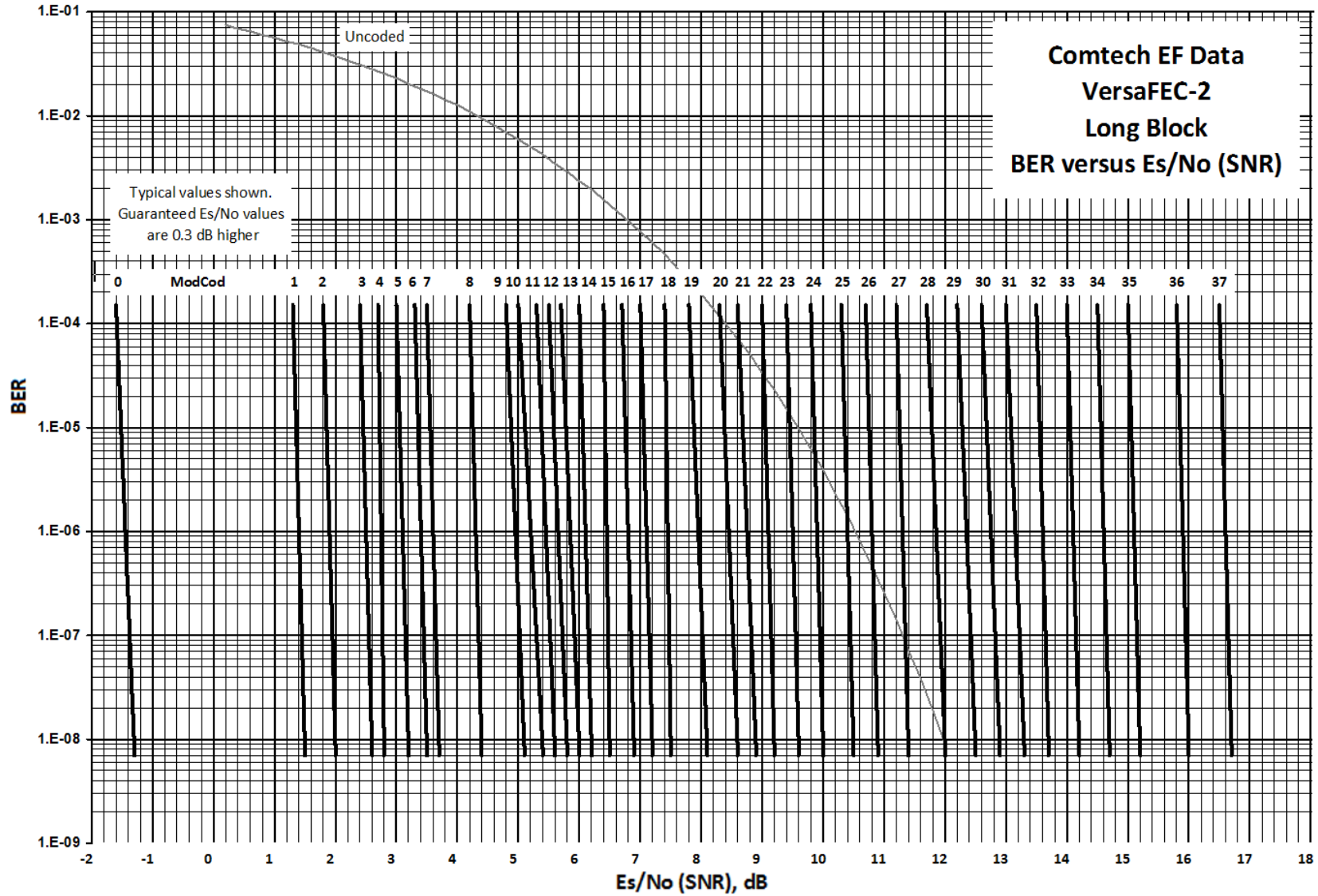

Figure B-18. VersaFEC-2 Long Block

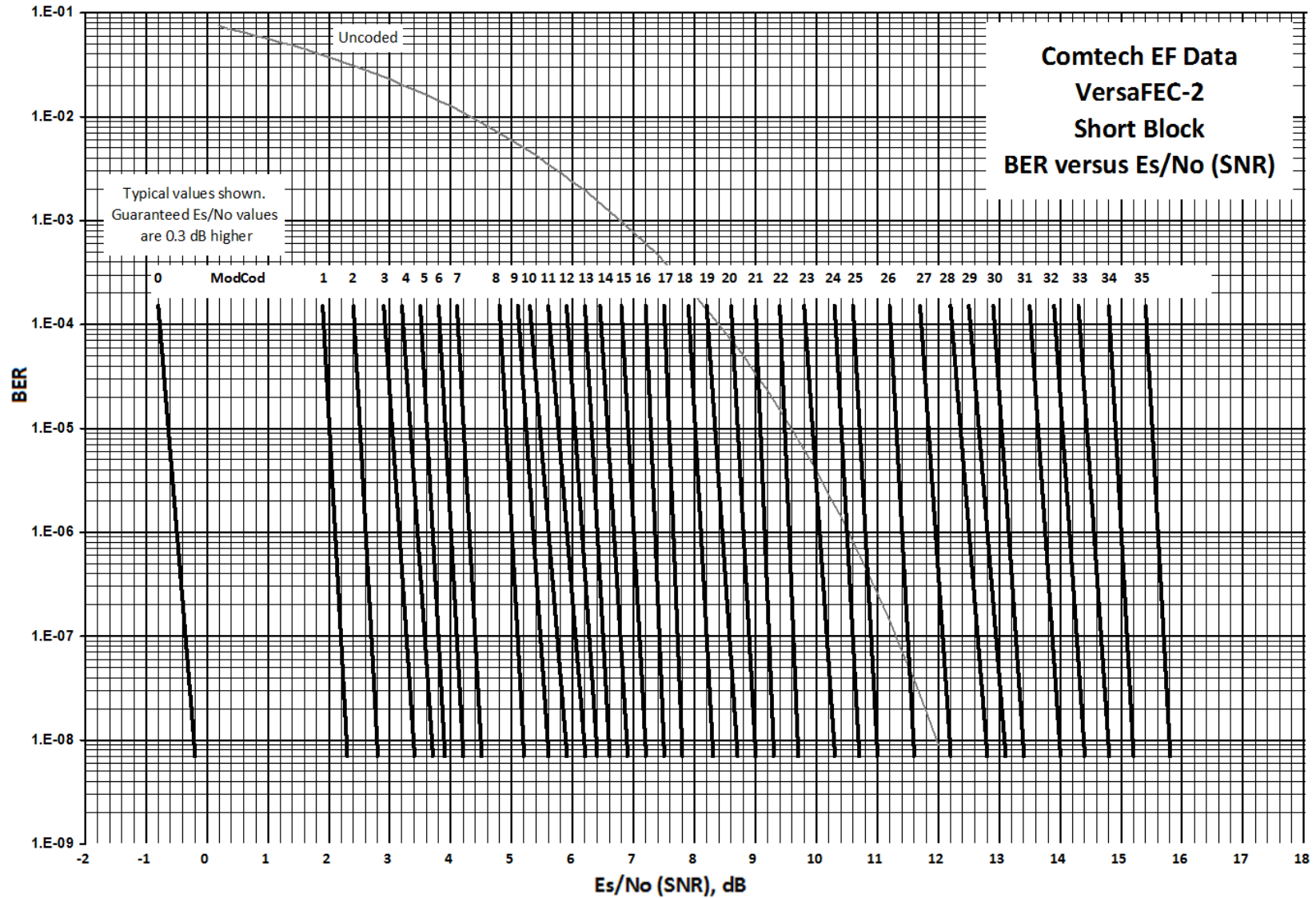
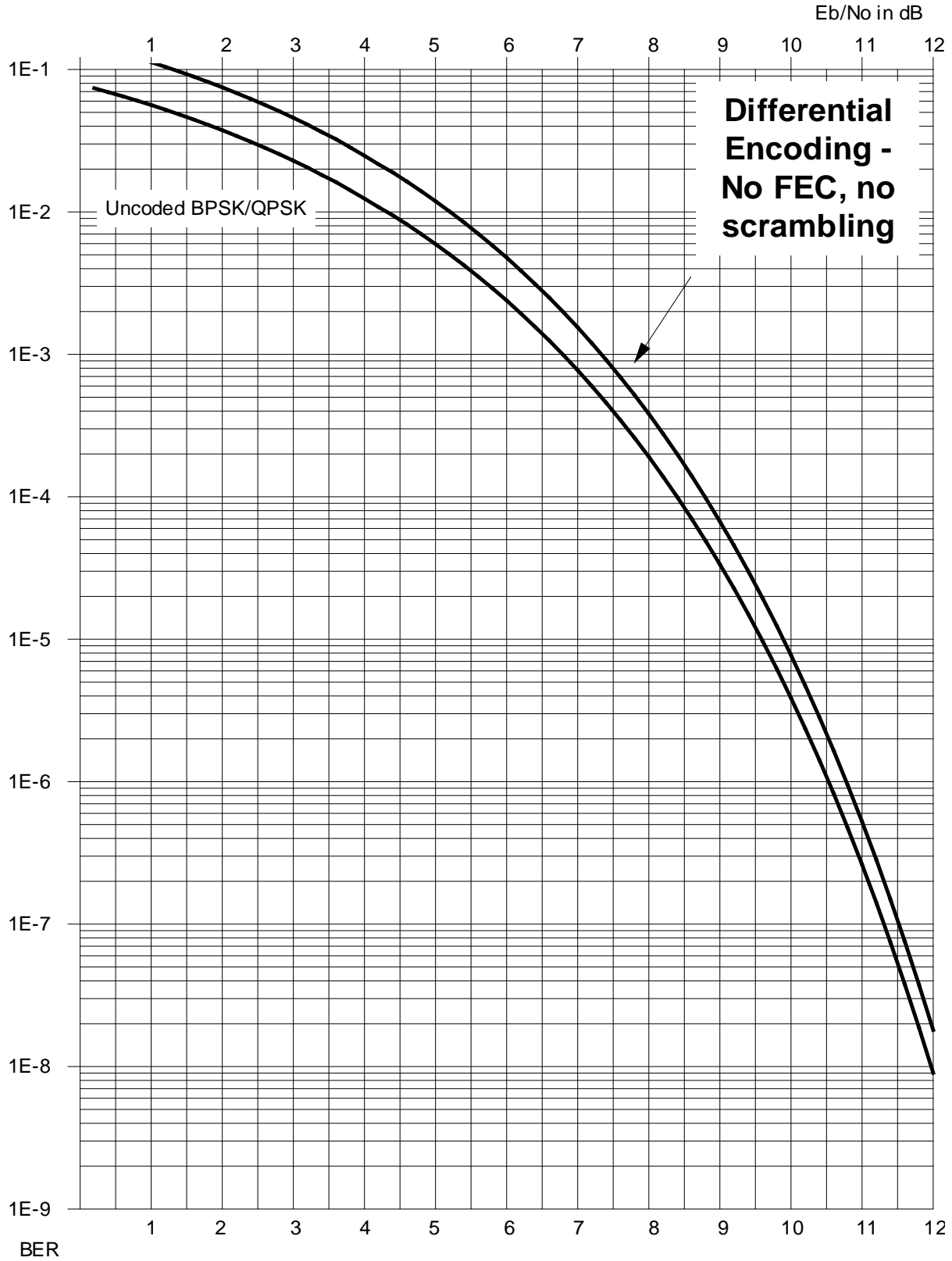

Figure B-19. VersaFEC-2 Short Block



**Figure B-20. Differential Encoding – No FEC, No Scrambling**

BLANK PAGE



# Appendix C. OFFSET QPSK OPERATION

Offset Quadrature Phase Shift Keying (OQPSK) modulation is a variation of normal QPSK that is offered in the CDM-570A/570AL Satellite Modem. Normal band-limited QPSK produces an RF signal envelope that necessarily goes through a point of zero amplitude when the modulator transitions through non-adjacent phase states. This is not considered to be a problem in most communication systems, as long as the entire signal processing chain is linear.

However, when band-limited QPSK is passed through a non-linearity (e.g., a saturated power amplifier), there is a tendency for the carefully filtered spectrum to degrade. This phenomenon is termed **spectral regrowth**, and at the extreme (hard limiting), the original unfiltered  $\sin(x)/x$  spectrum would result. In most systems, this would cause an unacceptable level of interference to adjacent carriers, and would cause degradation of the BER performance of the corresponding demodulator.

To overcome the problem of the envelope collapsing to a point of zero amplitude, Offset QPSK places a delay between I and Q channels of exactly 1/2 symbol. Now, the modulator cannot transition through zero when faced with non-adjacent phase states; the result is that there is far less variation in the envelope of the signal, and non-linearities do not cause the same level of degradation.

The demodulator must realign the I and Q symbol streams before the process of carrier recovery can take place. For various reasons, this makes the process of acquisition more difficult. In the CDM-570A/570AL, the two consequences of this are:

1. Demodulator acquisition may be longer than standard QPSK, especially at low symbol rates.
2. The acquisition threshold is slightly higher than for normal QPSK. This effect is only an issue for LDPC Rate 1/2 and TPC Rate 21/44 code rates, where the  $E_b/N_0$  values are typically less than 2 dB. In this case, the acquisition and tracking threshold is approximately 1dB higher than for QPSK.



# Appendix D. OPTIONAL HIGH-PERFORMANCE PACKET PROCESSOR

---

## D.1 Overview



**The High-Performance Packet Processor is available as a factory-installed option or as a field-upgradeable option (see Sect. D.1.1.3).**

The optional High-Performance Packet Processor makes the CDM-570A/570AL a high-performance, low-cost, IP-centric satellite modem that is well-suited for point-to-point and point-to-multipoint applications.

(This appendix identifies this optionally-equipped modem as the **CDM-570A/570AL-IP**. The CDM-570A/570AL-IP and other compatible, IP-centric Comtech EF Data modems may also be generically referred to throughout this appendix as the **CDM-IP**.)

In addition to providing both Layer 2/Layer 3 functionality, the CDM-570A/570AL-IP incorporates a number of key features for Wide Area Network (WAN) bandwidth optimization, including Header Compression, Payload compression, and Advanced Quality of Service (QoS).

The CDM-570A/570AL-IP enables efficient IP networking and transport over satellite, in either Router Mode or Managed Switch Mode, by adding routing capability with very low overhead encapsulation, header compression, payload compression, and QoS. The Advanced QoS combined with header and payload compression ensures the highest quality of service with minimal jitter and latency for real-time traffic, priority treatment of mission critical applications and maximum bandwidth efficiency.

The CDM-570A/570AL-IP can be used in a Vipersat Management System (VMS).



**Vipersat CDM-570/570L Satellite Network Modem User Guide (CEFD P/N MN/22125)**

## D.1.1 Operational Requirements

### D.1.1.1 Major Assemblies

Assembly	Description
PL-0021625	High-Performance Packet Processor Card (factory-installed)
KT-0020931	High-Performance Packet Processor Retrofit (Field Upgrade) Kit – See Sect. D.1.1.3

### D.1.1.2 Interoperability Compatibility/Limitations

- CDM-570A/570AL-IP → CDM-570A/570AL-IP Interoperability:** The CDM-570A/570AL-IP is **not** interoperable for IP/Ethernet Traffic with a CDM-570A/570AL that is **not** equipped with the optional Packet Processor.
- Modem Compatibility:** The CDM-570A/570AL-IP is compatible with other Comtech EF Data IP (CDM-IP) modems, provided the modems have similar operating modes and IP options when the CDM-570A/570AL-IP is configured to operate in **CDM-570 Compatibility Mode**.

The following Comtech EF Data IP products are compatible with the CDM-570A/570AL-IP:

Comtech EF Data IP Product	IP Module (HDLC Versions ONLY)*	Additional Restrictions
CDM-570/L Satellite Modem with IP Module	Version 1.6.9 or later	No restrictions
CDD-564/L Quad Demodulator with IP Module	Version 1.6.9 or later	No restrictions
CDD-562L Quad Demodulator with IP Module	Version 1.6.9 or later	No restrictions

- CDM-570A/570AL-IP → CDM-570/L-IP or CDD-564/L IP Quad Demodulator Interoperability:** A CDM-570A/570AL-IP is interoperable with the CDM-570/L-IP (CDM-570/L Satellite Modem w/Optional IP Module) and/or the CDD-564/L Quad Demodulator with IP Module using HDLC and compatible modulation, Forward Error Correction (FEC), symbol rate, etc.



\*The CDM-570A/570AL-IP is **NOT** compatible with the Streamline Encapsulation (SLE) version of the CDM-570/L, CDD-564/L, and CDD-562/L products.

---

### D.1.1.3 High-Performance Packet Processor Field Upgrade Procedure

#### D.1.1.3.1 Overview

This section describes the field upgrade procedure you need to follow to retrofit your CDM-570A/570AL Satellite Modem with the optional Packet Processor card. See Section D.1.1.2 in this appendix for the requirements and limitations of using the Packet Processor with the CDM-570A/570AL.

#### D.1.1.3.2 Requirements for Field Upgrade

- CDM-570A/570AL Satellite Modem
- Medium Phillips™ screwdriver
- CEFD P/N KT-0020931 Packet Processor Upgrade Kit, containing:

CEFD Part Number	QTY	Description
PL-0021625	1	CDM-570A/570AL-Packet Processor Card
HW/SEM440X1/4PH	4	Screw, S.S., 4-40 x 1/4 LG, Pan Head Phillips

### D.1.1.3.3 Field Upgrade Procedure

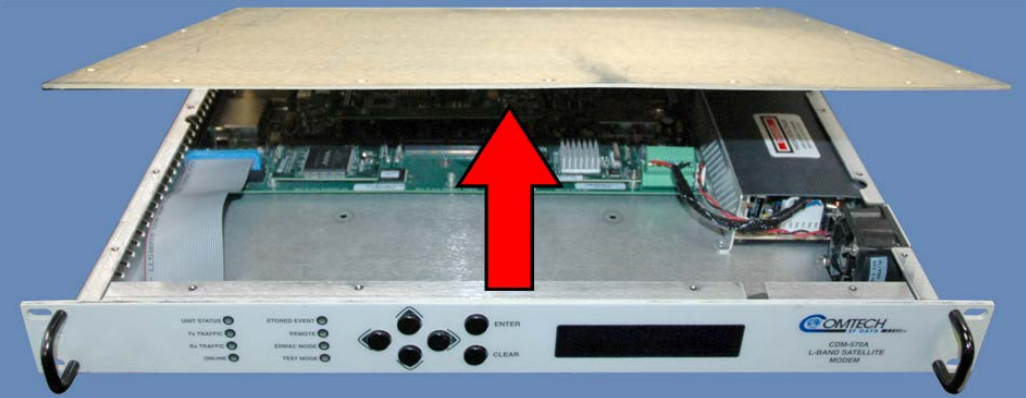
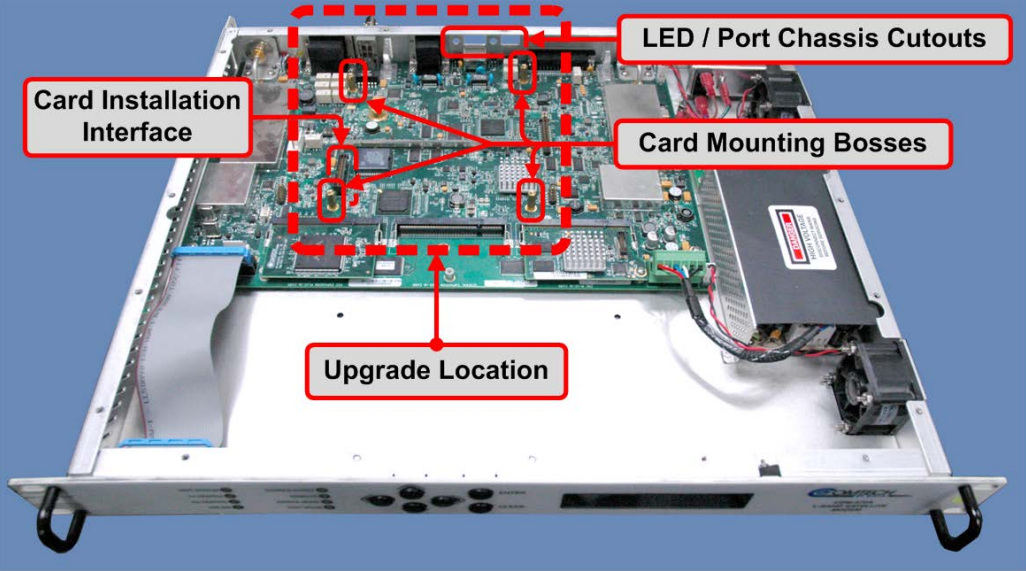
Step	Task	
1	<p>Turn off the CDM-570A/570AL and disconnect the modem's power cord from its power source.</p> <p>Next, use the screwdriver to remove the top cover mounting hardware.</p> <p>Remove the cover from the CDM-570A/570AL chassis.</p> <p><b>IMPORTANT:</b> Be sure to retain the top cover mounting hardware for cover re-installation once you have installed the Packet Processor Card.</p>	
2	<p>The illustration at right identifies the features within the chassis for assembly of the Packet Processor Card onto the chassis-mounted card bosses.</p>	

Step	Task
3	<p>Prepare the Packet Processor Card for installation by aligning its receptacle with the mating connector on the modem's framing board.</p> <p>Tilt the board slightly, in a downward angle, to align the RJ-45 and RJ-11 ports with their mating chassis rear panel cutouts.</p> <p>Then, plug the card firmly into the connector – take care not to damage any top- or bottom-mounted components.</p> <p>Similarly, be sure not to damage the bottom of the card on the chassis' mounting bosses while plugging the card receptacle into its mating connector.</p> <p>Installation is complete once the the card receptable is fully engaged within its mating connector, and the mounting holes at the front and rear of the card are aligned with the mounting boss threaded holes.</p>

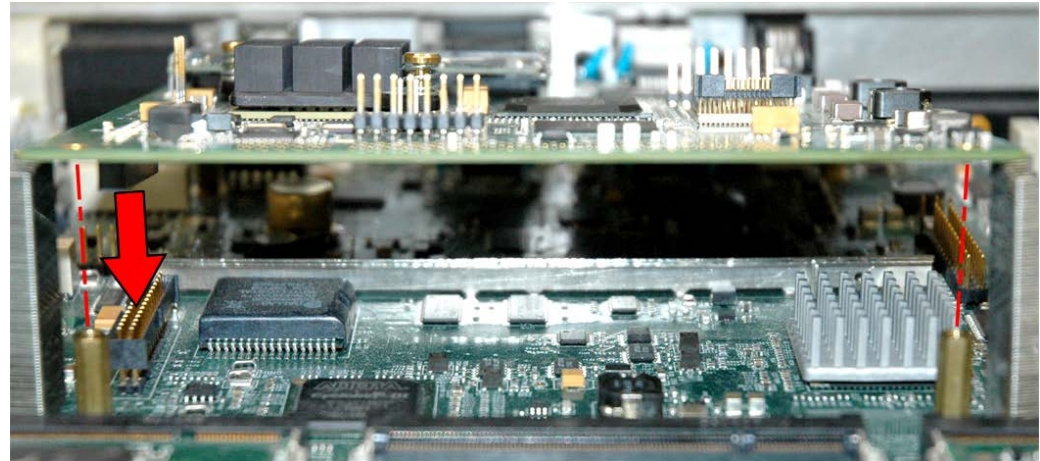

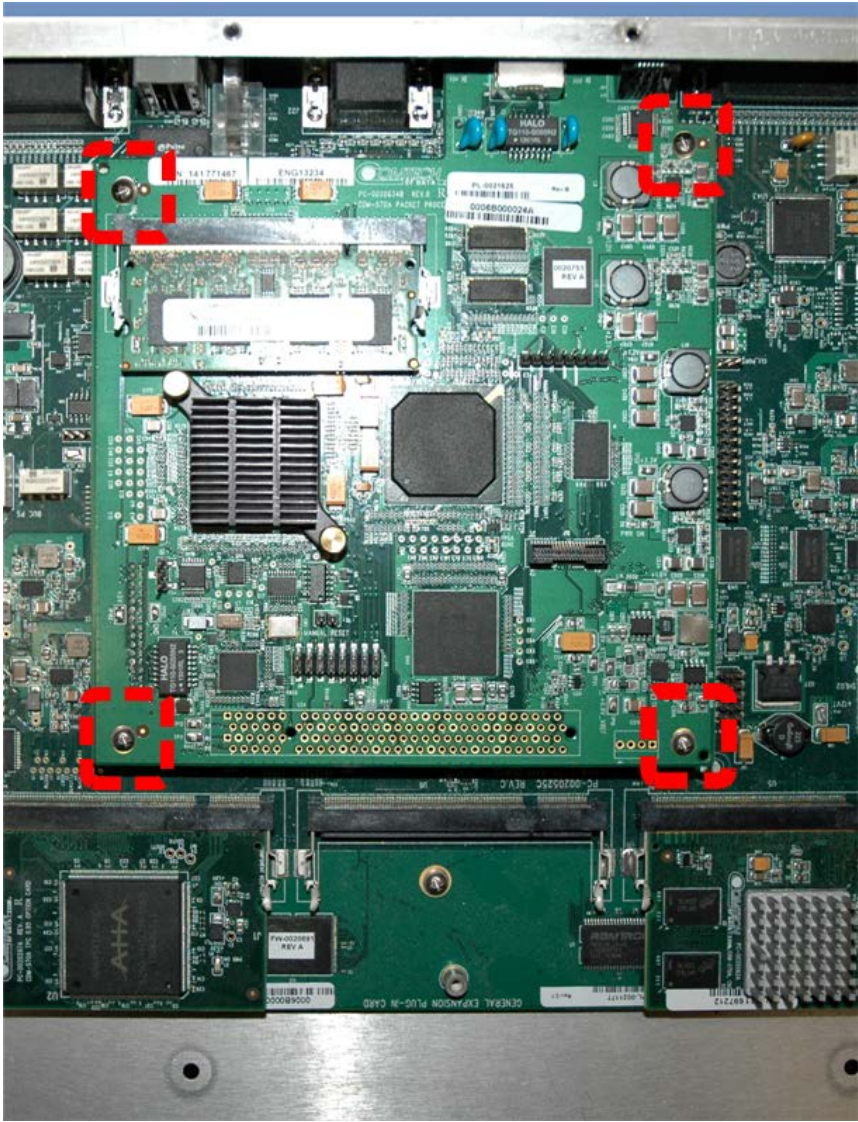
Step	Task
4	<p data-bbox="302 256 806 350">Use the screwdriver to secure the Packet Processor card to the chassis with its provided mounting hardware (4X 4-40 x 1/4 pan head screws).</p> 

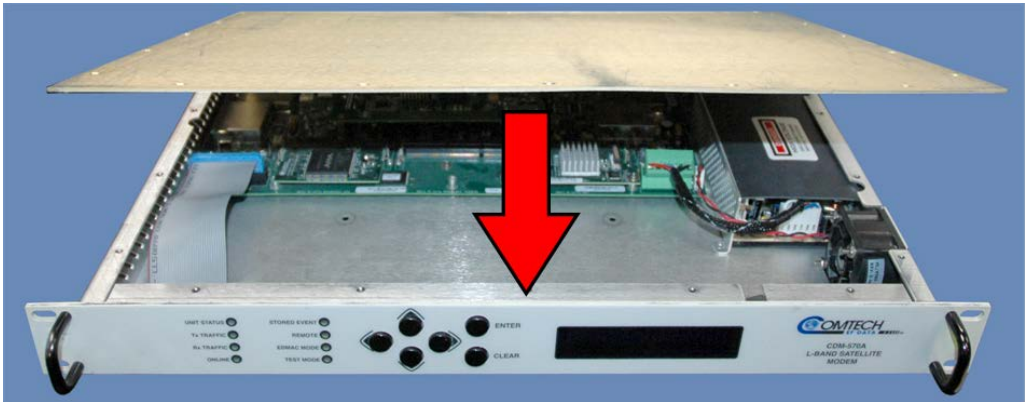

Step	Task
5	<p>Use the screwdriver to reinstall the top cover onto the CDM-570A/570AL chassis with its existing mounting hardware.</p> <p>Plug the modem's power cord back into its power source.</p> 

***The High-Performance Packet Processor upgrade is now complete. You may turn on and resume use of the modem.***



## D.1.2 High-Performance Packet Processor Features

- 10/100BaseT Ethernet Interface
- Network-Based Management:
  - HTTP Interface for complete product management
  - SNMP with public and private MIB
  - Console Port interface for local network management
  - Telnet interface for remote product M&C
  - Remote software/firmware upgrade via FTP
  - Configuration Backup and Restore via FTP
  - Event Logging to Capture all Packet Processor Activity
  - Detailed Statistics of IP traffic
- Header Compression (Layer 2 only)
- IGMP Support for Multicast
- Static IP Routing for Unicast and Multicast
- Managed Switch Mode with VLAN
- Adaptive Coding and Modulation (ACM)

---

### D.1.2.1 10/100 BaseT Ethernet Interface

In Router Mode operation, the 10/100BaseT Ethernet Interface is used for routing IP traffic to be transmitted over the satellite or routed to another device on the local LAN. In Managed Switch Mode, the Ethernet Interface is used to forward IP and non-IP traffic over the satellite. Local or remote management of all CDM-570A/570AL-IP (w/Packet Processor-related functions) is also available via Telnet, HTTP, or SNMP.

## D.1.2.2 Network-Based Management

Use any of the following methods to configure, operate, and monitor the CDM-570A/570AL-IP:

User Interface	Connection	Modem Functions	Packet Processor Functions	Manual Reference
Front Panel	Local - Keypad	ALL	IP Address/Subnet Mask only	Chapter 6
SNMP	Local or remote - Ethernet via 10/100 BaseT Traffic interface	ALL	ALL	Chapter 7.2
Telnet	Local or remote - Ethernet via 10/100 BaseT Traffic interface	ALL	ALL	Chapter 7.3
HTTP (Web Server)	Local or remote - Ethernet via 10/100 BaseT Traffic interface	ALL	ALL	Chapter 7.4
Serial Remote Control	Local - Serial RS-232/RS-485 via Remote Control Port	ALL	IP Address/Subnet Mask only	Chapter 8
Command Line Interface (CLI)	Local - Serial RS-232 via Console Port	ALL	ALL	Chapter 9
	Remote – Ethernet via 10/100 Base T Traffic Interface			

### D.1.2.2.1 Remote Software/Firmware Upgrade via FTP

The Packet Processor uses ‘flash memory’ technology internally. This simplifies firmware updating, and updates can be obtained over the Internet or through e-mail from Comtecgh EF Data Product Support. New firmware can be uploaded by FTP to the Packet Processor from a user-supplied PC without opening the unit or having to be in the same physical location.

### D.1.2.2.2 Configuration Backup and Restore via FTP

All Base Modem and Packet Processor configuration parameters are stored in a simple text file named “param1”. This parameter file can easily be retrieved locally or remotely by FTP. The file can then be used to quickly configure a replacement modem if needed.

**Packet Processor configuration file** – The “param1” file can be modified with a text editor (e.g., WordPad). After downloading this file from the CDM-570A/570AL-IP Modem to the User PC, edit the desired configuration settings and save the file under a name that identifies the modem’s network role (e.g., HUB570A\_param1.txt).

Do these steps:

1. Once you verify User PC-to-Modem communications, you may use Command-line to transfer (FTP) the configuration file from the CDM-570A/570AL-IP to the User PC:
  - a. Type "**ftp xxx.xxx.xxx.xxx**" (where ‘xxx.xxx.xxx.xxx’ is the CDM-570A/570AL-IP Ethernet Traffic/Management IP Address).
  - b. Type the Admin User Name and Password when prompted. The default User Name and Password is “**comtech**”.

- c. At the "**ftp >**" prompt, type "**get param1**" to download the parameter file.
    - d. Type "**bye**" to close the FTP session.
  2. Use a text editor (e.g., WordPad) to edit the downloaded param1 text file and save it to a unique name.
  3. Use FTP to upload the configuration settings file from the User PC into another CDM-570A/570AL-IP Modem:
    - a. Type "**ftp xxx.xxx.xxx.xxx**" (where '**xxx.xxx.xxx.xxx**' is the CDM-570A/570AL-IP Ethernet Traffic/Management IP Address).
    - b. Type the Admin User Name and Password when prompted. The default User Name and Password is "**comtech**".
    - c. At the "**ftp >**" prompt, type "**put param1**" (i.e., the name of your custom configuration file) to upload the parameter file from the User PC to the CDM-570A/570AL.
    - d. Type "**bye**" to close the FTP session.

### D.1.2.2.3 Event Logging to Capture All Packet Processor Activity

All Packet Processor activity is stored in a simple text file named "eventlog". This easy-to-read Event Log can be retrieved locally or remotely by FTP.

Do these steps:

1. Once you verify User PC-to-Modem communications, you may use Command-line to transfer (FTP) the Event Log file from the CDM-570A/570AL-IP to the User PC:
  - a. Type "**ftp xxx.xxx.xxx.xxx**" (where '**xxx.xxx.xxx.xxx**' is the CDM-570A/570AL-IP Ethernet Traffic/Management IP Address).
  - b. Type the Admin User Name and Password when prompted. The default User Name and Password is "**comtech**".
  - c. At the "**ftp >**" prompt, type "**get eventlog**" to download the file.
  - d. Type "**bye**" to close the FTP session.
2. Use a text editor (e.g., WordPad) to open and review the Event Log.

#### D.1.2.2.4 Detailed Statistics of IP Traffic

IP traffic statistics are continuously updated and allow detailed performance analysis or can be used to identify traffic problems. The statistics are available through the Serial Console locally, or can be gathered remotely by Telnet, HTTP, or SNMP.

---

#### D.1.2.3 Static IP Routing for Unicast and Multicast

Up to 256 static routes can be entered into the Packet Processor to direct IP traffic over the satellite or to another device on the local LAN. These 256 routes could be in any combination of unicast and multicast.

---

#### D.1.2.4 IGMP Support for Multicast

IGMP is a standard feature in the Packet Processor. If enabled, it responds to IGMP queries for the configured multicast routes on the transmit side and generates IGMP queries on the receive side. If there are no active IGMP receivers on the LAN, it will stop forwarding the multicast traffic (received from the satellite) to the LAN.

---

#### D.1.2.5 Managed Switch Mode

Managed Switch Mode is the Comtech EF Data IP modem intelligent networking solution that allows a link to be setup with minimal configuration (no specific routes need to be configured). The Packet Processor also supports non-IP traffic with Managed Switch Mode. All IP traffic will be subject to user-configured QoS restrictions.

##### D.1.2.5.1 Managed Switch Mode Operation



1. **Managed Switch Mode will automatically use Header Compression for compressing Layer 2 (even if Header Compression option has not been purchased). Because of this, some of the initial traffic sent between two devices will not be received over the satellite until a full Header is transmitted. For example, the default Header Compression Refresh Rate is 50 packets. If a ping is sent over the satellite, then it will time out until the full Header packet is sent. The Header Compression Refresh Rate on the Administration Menu can be reduced to minimize the amount of traffic lost when traffic is first sent between two devices. Once communication between two devices has been established, both IP modems will be able to receive all traffic, unless one IP modem is power cycled or reset. Header Compression feature should be enabled for compressing Layer 3, Layer 4 and Layer 5.**

2. **Do not enable IF Loopback (or link the TX to RX by a BNC cable or satellite) on an IP modem operating in Managed Switch Mode when connected to a LAN. In this configuration, Managed Switch Mode will resend all Layer 2 broadcast packets and cause a “broadcast storm” on the LAN. To perform a loop test to verify the modem or satellite link, do one of the following:**
  - a. **Reconfigure the CDM-570A/570AL-IP interface selection: From the front panel, select Config→ Intfc, and then select RS422, V.35, or RS232.**  
  
- OR -
  - b. **Set the Packet Processor to Router Mode.**

Information about the function of Managed Switch Mode, as well as a detailed description for the setup and configuration of a Managed Switch Mode pair, is as follows:

- Because Managed Switch Mode is a “smart wire,” the devices attached to it on either side of the satellite should be on the same subnet and should not configure a next hop address to be the CDM-570A/570AL-IP address (as should be done with router mode). For purposes of configuration, Managed Switch Mode should be viewed to function in much the same way as a bridge (however, without spanning tree protocol).
- All of the features that groom and optimize the satellite link in router mode are also available in Managed Switch Mode.
- Managed Switch Mode Multicast Option – Multicast packets in Managed Switch Mode are identified using multicast MAC address. These identified multicast packets are either routed or dropped based on the Managed Switch Mode multicast option.
- Managed Switch Mode uses Layer 2 (MAC) addresses to learn where to send packets. In comparison, router mode uses the destination IP address in the packet in conjunction with the route table to determine where to forward the packets.
- The Packet Processor in Managed Switch Mode is configured to be in promiscuous mode with a data rate of 10/100BaseT Half Duplex/Full Duplex. The Packet Processor needs to be in promiscuous mode in order to learn the attached networking devices.
- Since Managed Switch Mode does not use a routing table, the determination of where to send a packet is made by a learning process. When the system is powered-up, all packets from each subnet (local and remote) will be sent over the satellite interface. However, as each Packet Processor learns which devices are attached to their local Ethernet interfaces, the Packet Processor begins to filter packets which it has learned are locally attached to its Ethernet interface.
- The Managed Switch Mode learning/forwarding algorithm is as follows:
  - If the packet is destined for the Packet Processor, then process it locally.
  - If the packet is from the Packet Processor Interface, then send it to the Satellite interface; OR if the destination Layer 2 (MAC) address of the packets matches the source Layer 2 address for a packet we have already seen, then the destination MAC address of this packet is on our local subnet; so why send it over the satellite interface. In this case, the Packet Processor will drop the packet.
  - If the packet is from the satellite interface, then send it out the Ethernet interface.

- Managed Switch Mode also supports VLAN's and when VLAN Mode is enabled, will forward traffic as follows:
  - If an untagged packet arrives at the Packet Processor, it will egress as a tagged packet with the defined Native VLAN ID.
  - VLAN entries can be added into the VLAN Table and to forward VLAN's over the satellite. A VLAN entry is also needed on the receiving CDM-570A to receive the VLAN traffic and they will egress as tagged VLAN's.
  - If a tagged packet arrives at the Ethernet port, it will only be forwarded if there is a matching VLAN entry in the VLAN Table and it will egress as tagged. If there is no matching VLAN in the VLAN Table, the tagged packet will be dropped.
- VLAN operation in the CDM-570A/570AL-IP also includes full 802.1Q VLAN QoS support. With the QoS Option enabled, the Packet Processor will read the 802.1Q VLAN Priority (7 through 0) that is in the VLAN Header in each VLAN frame received and will prioritize traffic accordingly.

### D.1.2.5.2 Combined Working Mode

In order greatly simply the configuration complexity, the working modes operation of modem have been centralized in the single Working Mode configuration parameter, which in turn offer the following functional parameters:

Mode Selection	Function
Managed Switch	Managed switch with support for VLAN as well as advanced features such as QoS, Header Compression and Payload Compression. Primarily intended for operation in a point-to-point topology.
Router – Small Network Mode	Hub side router in a Point-to-Multipoint network. Allows Sat-to-sat.
Router – Large Network Mode	Remote Router in a Point-to-Multipoint network. Packets from the WAN are not allowed to be sent to the WAN. No longer requires HDLC receive addresses to be configured.
Router – Point to Point	Point-to-Point router in Point-to-Point configurations.
Router – Vipersat	Hub router in a Vipersat Network.



**The Vipersat “Unit Role” and “Expansion Role” parameters are not read-only.**



---

## D.1.2.6 Adaptive Coding and Modulation (ACM)



### Appendix P. ADAPTIVE CODING and MODULATION (ACM) OPTION

Comtech EF Data's VersaFEC® Adaptive Coding and Modulation (ACM) feature is a patents-pending technology wholly owned and developed by Comtech EF Data and Comtech AHA Enterprise Products Group. It can be used with the Packet Processor to maximize throughput. ACM converts available link margin into additional throughput, thereby maximizing throughput under all conditions, including rain fade, inclined orbit satellite operation, antenna mispointing, interference and other impairments.

---

## D.1.2.7 High-Performance Packet Processor Optional FAST Features



- **Chapter 5. FAST ACTIVATION PROCEDURE**
- **Sect. 6.3.7.7 UTIL: FAST (FAST Code Options) (Chapter 6. FRONT PANEL OPERATION)**

If you wish to upgrade the CDM-570A/570AL's optional Packet Processor functionality, Comtech EF Data provides Fully Accessible System Topology (FAST). FAST technology permits the purchase and installation of options through special authorization codes. These unique Fast Access Codes may be purchased from Comtech EF Data Product Support, and then loaded into the unit using the front panel keypad.



**All IP FAST Options may be temporarily enabled using the 30-day Demo Mode.**

Optional FAST Features are:

- IP Header Compression
- Payload Compression
- Advanced Quality of Service (QoS)
- Vipersat (VMS – Vipersat Management System)
- VFS (Vipersat File Streaming)

### D.1.2.7.1 CDM-570A/570AL-Packet Processor in Demo Mode

Demo Mode temporarily enables the IP optional FAST features listed in **Sect. D.1.2.7**.

Demo Mode has a cumulative counter that can be stopped and started at any time, for a total time duration of up to 30 calendar days. You may control Demo Mode operation from either the CDM-570A/570AL-IP front panel or the CDM-570A HTTP (Web Server) Interface:

**From the CDM-570A/570AL-IP front panel – Select (UTIL: FAST) FAST Configuration → Demo Mode → ON. Press ENTER. The Demo Mode Timer decrements from 2592000 seconds (30 calendar days) but can be stopped at any time by setting Demo Mode to OFF.**

From **CDM-570A HTTP Interface** – Use the **Admin | FAST** page Demo Mode drop-down list to set operation as **Enabled**, and then click **[Submit]**. The Demo Mode timer decrements via the **Demo Time Remaining: XX days XX hours XX minutes** banner. To stop Demo Mode at any time, use the drop-down list to set operation as **Disabled**.



**Make sure to reboot the unit any time you turn Demo Mode ON (Enabled) or OFF (Disabled).**

## D.1.2.7.2 Header and Payload Compression

### D.1.2.7.2.1 IP Header Compression

The Packet Processor incorporates industry-leading header compression for IP traffic. Header compression can reduce the 40-byte IP/UDP/RTP header to as little as 1 byte; for TCP/IP, the 40-byte header is reduced to as little as 3 bytes. For applications such as Voice-over-IP (VoIP), header compression can provide bandwidth savings exceeding 60%.

**For example**, the 8 kbps G.729 voice codec requires 24 kbps of IP bandwidth once encapsulated into an IP/UDP/RTP datagram. Using IP/UDP/RTP Header Compression, the same traffic only needs 10.8 kbps total WAN satellite bandwidth to cross the link. A total maximum of 64 simultaneous VoIP calls can be compressed. Normal HTTP (Web) traffic can be reduced an additional 10% via IP/TCP header compression.

In addition, bandwidth requirements for typical Web/HTTP traffic can be reduced by 10% or more with TCP/IP header compression. The Packet Processor supports Header Compression for the following Ethernet and Layer 3, 4 & 5 Headers:

Supported Ethernet Headers
Ethernet 2.0
Ethernet 2.0 + VLAN-tag
Ethernet 2.0 + MPLS
802.3-raw
802.3-raw + VLAN-tag
802.3 + 802.2
802.3 + 802.2 + VLAN-tag
802.3 + 802.2 + SNAP
802.3 + 802.2 + SNAP + VLAN-tag
802.3 + 802.2 + SNAP + MPLS

Supported Layer 3 & 4 Headers
IP
TCP
UDP
RTP (Codec Independent)

Note the following:

- Header Compression Configuration** is completely independent from QoS, and there is no configuration required except enabling the Header Compression feature on both the sending and receiving Comtech EF Data IP modem. Packets with a Header Compression supported header will automatically be identified for compression. The only configuration consideration is the Header Compression Refresh Rate. This is how many compressed header packets will be sent before a single full header packet is sent. Some compressed header traffic could be lost during deteriorated satellite link conditions. Sending a full header packet will allow the return of the traffic stream. The Refresh Rate can be increased for poor satellite link conditions or decreased to further reduce overhead.

- **Header Compression Statistics** will display the total bytes of the pre-compressed and post-compressed traffic and effective compression ratio.

### D.1.2.7.2.2 Payload Compression

The Packet Processor features industry-leading payload compression for IP traffic. Implemented in the hardware for maximum throughput and efficiency, payload compression can reduce the required satellite bandwidth by as much as 40–50%. Traffic optimization through Payload Compression is an optional feature of the Packet Processor. Note the following:

- Available as a FAST feature
- Uses AHA chip
- Compression algorithm applied to all data (HDLC header excluded)
- Compression statistics are fed back to QoS in order to maximize WAN utilization while maintaining priority, jitter and latency
- 1024 simultaneous compression sessions to maximize compression across multiple distinct traffic flows
- Compression algorithm not applied to RTP streams because this traffic is already compressed and would only INCREASE the sat bandwidth if compressed again
- Additional statistics have been added to the compression statistics menu in order to provide feedback on the compression efficiency that has been achieved
- Payload Compression is selectable on a per route basis

### D.1.2.7.2.3 ALDC vs. LZS Compression Comparison Table



The numbers in Table D-1 were compiled using a test program created in-house by Comtech EF Data. This program takes the target benchmark files and splits the files into payload-sized chunks, then compresses each chunk in a separate invocation of the compression algorithm. This is important to note because most compression algorithms are applied to the entire file data set as a single invocation of the compression algorithm, which is easier for other types of compression algorithms (LZS, GZip specifically). This, of course, does not apply to streamed packet data across an IP network (e.g., FTP transfer).

**Table D-1. ALDC vs. LZS Compression Comparison**

Algorithm	Payload size	File Set	Ratio
ALDC	1472	Calgary	1.76
	1000		1.76
	500		1.77
	100		2.09
	1472	Canterbury	1.71
	1000		1.72
	500		1.74
	100		2.04
LZS	1472	Calgary	1.66
	1000		1.66
	500		1.68
	100		1.97
	1472	Canterbury	1.61
	1000		1.62
	500		1.63
	100		1.91

---

## D.1.2.8 Advanced Quality of Service (QoS)



### Appendix L. ADVANCED QUALITY OF SERVICE (QoS)

Advanced QoS is an optional feature of the Packet Processor. Advanced QoS enables a network to use WAN bandwidth more efficiently by managing delay, jitter (delay variation), throughput, and packet loss. It is based on OSI model to Layer 7 protocol header parameters. Advanced QoS requires that the optional Packet Processor is installed and active, and requires that you purchase and activate the Advanced QoS FAST Option. Contact Comtech EF Data Product Support for further information.

The CDM-570A/570AL-IP incorporates four Per Hop Behavior (PHP) QoS modes of operation:

- **Max/Pri Mode – QoS Rules based on Maximum Bandwidth and Priority.**  
This mode provides multi-level traffic prioritization with the ability to limit maximum traffic per priority class.
- **Min/Max Mode – QoS Rules based on Minimum and Maximum Bandwidth.**  
This mode provides a Committed Information Rate (CIR) to each user-defined class of traffic with the ability to allow a higher burstable rate depending on availability
- **DiffServ Mode – Differentiated Services.**  
This mode incorporates the industry-standard method of providing QoS, enabling seamless co-existence in networks that implement DiffServ.
- **VLAN Priority Max Mode – VLAN 802.1q**

When using rule-based QoS, you can configure up to 32 different rules based on:

- Source IP address and subnet mask;
- Source Port;
- Protocols (well known);
- Destination IP address and subnet mask;
- Destination Port;
- Priority.

---

## D.1.2.9 Vipersat / VFS



**For specific information about CDM-570A/570AL-Packet Processor operation when deployed in a Vipersat satellite bandwidth management system, see adjunct Comtech EF Data publication Vipersat CDM-570/570L Satellite Network Modem User Guide (CEFD P/N MN/22125)**

---

## D.1.2.10 3xDES Encryption with Ability to Change Keys

Future releases of the Packet Processor will optionally support 3xDES-128 (using NIST certified 3x core) encryption and decryption, for the highest level security for link encryption.

## D.1.3 CDM-570A/570AL-IP – Operation and Control

Functionality and selection of the CDM-570A/570AL-IP features, modes of operation, and monitor and control (M&C) is seamless via these operational interfaces.

---

### D.1.3.1 Front Panel Operation



#### Chapter 6. FRONT PANEL OPERATION



Using the keypad on the front panel, you may access a variety of nested menus to configure the options available whenever the CDM-570A/570AL is equipped with the optional Packet Processor.

---

### D.1.3.2 Ethernet-based Remote Product Management



#### Chapter 7. ETHERNET-BASED REMOTE PRODUCT MANAGEMENT

The CDM-570A/570AL 10/100 BaseT Ethernet Management Interface supports three management protocols for remote monitor and control (M&C) of the modem:

- **Simple Network Management Protocol (SNMP)** – This requires a user-supplied Network Management System (NMS) and a user-supplied Management Information Base (MIB) File Browser.
- **Telnet Interface** – This requires use of a user-supplied terminal emulation program installed on the user PC, such as HyperTerminal (for use with the remote control protocol) or PuTTY (for use with the Telnet Command Line Interface).
- **CDM-570A HTTP (Web Server) Interface** – This requires a compatible user-supplied web browser such as Internet Explorer.

---

### D.1.3.3 SNMP Interface



#### Sect. 7.2 SNMP Interface (Chapter 7. ETHERNET-BASED REMOTE PRODUCT MANAGEMENT)

The Simple Network Management Protocol (SNMP) is an Internet-standard protocol for managing devices on IP networks. An SNMP-managed network consists of three key components:

- **The managed device** – This includes the CDM-570A/570AL-IP.
- **The SNMP Agent** – The software that runs on the CDM-570A/570AL. The CDM-570A/570AL-IP SNMP Agent supports both **SNMPv1** and **SNMPv2c**.
- **The user-supplied Network Management System (NMS)** – The software that runs on the manager.

### D.1.3.4 Telnet Interface



- Sect. 7.3 Telnet Interface (Chapter 7. ETHERNET-BASED REMOTE PRODUCT MANAGEMENT)
- Chapter 8. SERIAL-BASED REMOTE PRODUCT MANAGEMENT
- Chapter 9. OPTIONAL PACKET PROCESSOR – SERIAL/TELNET CLI OPERATION

Comtech EF Data provides a Telnet interface for the purpose of equipment monitor and control (M&C) using either remote control commands and queries or, when equipped with the optional Packet Processor, the Telnet Command Line Interface (CLI) (Figure D-1).

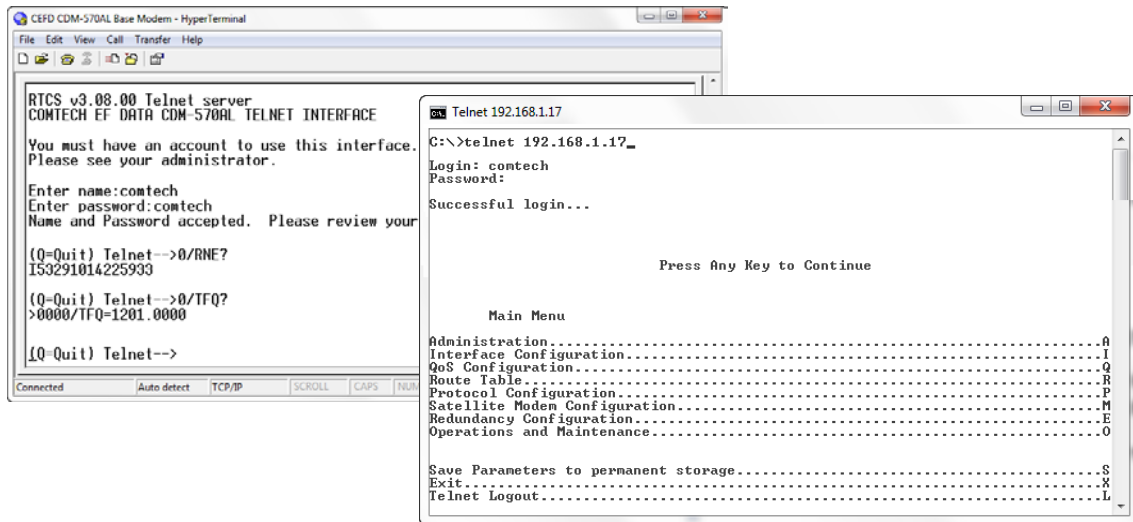

Figure D-1. CDM-570A/570AL-IP Telnet Interfaces (Serial Remote / CLI)

### D.1.3.5 CDM-570A HTTP (Web Server) Interface



#### Sect. 7.4 CDM-570A HTTP (Web Server) Interface (Chapter 7. ETHERNET-BASED REMOTE PRODUCT MANAGEMENT)

The embedded HTTP application (**Figure D-2**) provides an easy-to-use interface designed for optimal performance when using Microsoft's Internet Explorer Version 9.0 or higher. The interface features enhanced functionality when the CDM-570A/570AL is equipped with the Packet Processor.



CDM-570AL L-BAND Satellite Modem

Base Modem Firmware Version 1.5.1

Packet Processor Firmware Version 1.5.1c

This web page interface is best viewed at **1152 x 864** resolution  
using **IE 7 to 10** on a 17" or larger monitor.

**Figure D-2. CDM-570A HTTP (Web Server) Interface Home Page**

## D.1.4 High-Performance Packet Processor Specifications – Supported RFCs (Requests for Comment) and Protocols

RFC No.	Description
768	User Datagram Protocol
791	Internet Protocol
792	Internet Control Message Protocol
793	Transmission Control Protocol
826	Ethernet Address Resolution Protocol
856	Telnet Binary Transmission
862	Echo Protocol
894	A Standard for the Transmission of IP Datagrams over Ethernet Networks
919	Broadcasting Internet Datagrams
922	Broadcasting Internet Datagrams in the Presence of Subnets
950	Internet Standard Subnetting Procedure
951	Bootstrap Protocol (BOOTP)
959	File Transfer Protocol
1071	Computing the Internet Checksum
1112	Host Extensions for IP Multicasting
1213	Management Information Base for Network Management of TCP/IP-based internet: MIB-II
1350	The TFTP Protocol
1700	Assigned Numbers
1812	Requirements for IP Version 4 Routers
2045	Multipurpose Internet Mail Extensions (MIME)
2236	Internet Group Management Protocol, Volume 2
2474	Definition of the Differentiated Services Field (DS Field) in the IPv4 and IPv6 Headers
2475	An Architecture for Differentiated Services
2578	Structure of Management Information Version 2 (SMIv2)
2597	Assured Forwarding PHB
2598	An Expedited Forwarding PHB
2616	Hypertext Transfer Protocol – HTTP/1.1
2821	Simple Mail Transfer Protocol
2933	Internet Group Management Protocol MIB
3412	Message Processing and Dispatching for the Simple Network Management Protocol (SNMP)
3416	Version 2 of the Protocol Operations for the Simple Network Management Protocol (SNMP)
3418	Management Information Base (MIB) for the Simple Network Management Protocol (SNMP)
4293	Management Information Base for the Internet Protocol (IP)



## D.2 High-Performance Packet Processor – Quick Start Guide

This section serves to guide you through the steps needed to pass IP traffic within minutes of initial installation and setup (i.e., starting from factory default settings), using a pair of CDM-570A/570AL-IPs. This section refers generically to any Comtech EF Data IP-centric modem as the **CDM-IP**.

This section assumes operator familiarity with configuration of base modem operations.

### D.2.1 Getting Started

#### D.2.1.1 Equipment List

Use the following equipment:

Description	Qty	Comments
CDM-IP Modem	2	CDM-570A/570AL Satellite Modem w/optional Packet Processor and/or any other compatible, IP-centric Comtech EF Data modem.  <b>Note:</b> You may need to provide equipment to convert 70 MHz IF to L-Band for a duplex connection, depending upon modems.
Layer 2 Ethernet Switch or Hub	2	Supplied by User.  <b>Note:</b> RJ-45 crossover Ethernet cables can be substituted to directly connect the User PC to the CDM-IP Modem without the use of a hub.
Windows-based PC with Network Interface Card (NIC), terminal emulation program, and compatible Web browser	2	Supplied by User.
Console cable (DB-9 to RJ-11)	1	Supplied by Comtech EF Data (CEFD P/N PL/9396-1).
Ethernet cables (CAT5)	4	Supplied by User.
IF Coaxial cables	2	Supplied by User to interconnect Tx-Rx between both CDM-IP modems.

#### D.2.1.2 Equipment Setup

Do these steps:

Step	Task
1	Use CAT5 Ethernet cables to connect each CDM-IP rear panel "Traffic 100" port to the User PC via the Ethernet hub or switch.
2	Use coaxial cables to connect the Tx IF on <b>CDM-IP 1</b> to Rx IF of <b>CDM-IP 2</b> , and the Rx IF on <b>CDM-IP 1</b> to the Tx IF of <b>CDM-IP 2</b> .
3	Connect the DB-9 end of the CEFD P/N PL/9396-1 console cable to the COM1 or COM2 port of the User PC, and the RJ-11 end to the <b>CDM-IP 1</b> rear panel Console port.
4	Connect the <b>CDM-IP 1</b> and <b>CDM-IP 2</b> to suitable power supplies and turn them <b>ON</b> .

## D.2.2 Transmit and Receive IF Configuration

Do these steps:

Step	Task
1	Use the CDM-IP 1 and CDM-IP 2 front panels to configure the Tx and Rx IF parameters.  <b>Note:</b> The IF parameters can also be set via Console CLI, Telnet, HTTP (Web Server) Interface and SNMP. For this procedure, however, it is recommended that you use the modem front panel.
2	Set the TxPower to minimum level.
3	Before proceeding to next step, make sure that each CDM-IP is appropriately carrier-locked to the other CDM-IP.

## D.2.3 Command Line Interface (CLI) Configuration



### Chapter 9. OPTIONAL PACKET PROCESSOR – SERIAL/TELNET CLI OPERATION

Do these steps:

Step	Task
1	Launch the user-supplied terminal emulation program (e.g., HyperTerminal).
2	Select the appropriate COM port to which the DB-9 end of the console cable is connected, and configure the port as follows: <ul style="list-style-type: none"> <li>▶ 38400 bps</li> <li>▶ 8 data bits</li> <li>▶ No parity</li> <li>▶ 1 stop bit</li> <li>▶ No hardware flow control</li> </ul>
3	Press <b>Enter</b> to bring up the CLI login prompt, and then the CLI <b>Main Menu</b> . The default User Name and Password is <b>comtech</b> .

### D.2.3.1 Telnet CLI Operation Quick Reference

The CLI operates under a hierarchy of Configuration and Information functions. You may access any nested configuration or information page (e.g., Administration, Route Table, etc.) from this top-level menu by typing an available “Hot Key”, commonly provided at the right side of the screen.

- **Common Interface Options/Fields** – The bottom of each primary and nested page provides three menu functions that are typical throughout the CLI:

Selection	Hot Key	Description
Save Parameters to permanent storage	S	Saves the current configuration of the Packet Processor to permanent storage. This configuration is restored on each successive power cycle.
Exit	X	Exits the current menu and returns to the parent menu. You may alternately press the <b>Esc</b> key to perform the same action.
Telnet Logout	L	Exits the CLI and closes the terminal emulator application.

M&C is accomplished as follows:

- **Selection** – This is the function or command as it appears on the menu page.
- **Hot Key** – This is the letter or number assigned as the keystroke/mnemonic for execution of a menu function or command. Where this column specifies **[RO]**, this means that this line item is a **read-only** (informational) feature. No user input is available.
- **Description** – This is the detailed explanation of the function or command. You are instructed to take a specific action here:
  - When you are instructed to “set” a feature, this means that you are prompted to type the numerical value for that feature. Press [Enter] to execute configuration. User guidance to “set” a value within a permitted ranges (from a minimum value to a maximum value) is commonly provided in parentheses or brackets.
  - When you are instructed to “select” a feature, this means that a numbered list of choices is commonly provided. Type the number to execute your operational selection. Press [Enter] to execute configuration.
  - When you are instructed to “toggle” a feature, this generally means that pressing the Hot Key executes one of two operating states for that feature (e.g., Enabled or Disabled, On or Off, Auto or Manual, etc.). The feature line will dynamically update to display, in brackets, its updated and current operating state.

## D.2.4 Restoring Factory Default Configuration

The configuration procedures provided in this chapter assume that the CDM-IP is still in factory default configuration for IP. If this is not the case, the factory default configuration can be restored from the CLI menu.

Do these steps (the applicable CLI “hot key” is shown in brackets [#]):

Step	Task
1	From the CLI Main Menu: Select <b>Operations and Maintenance</b> submenu [O].
2	From the <b>Operations and Maintenance</b> menu: Select <b>Database Operations</b> submenu [D].
3	From the <b>Database Operations</b> menu: Select <b>Restore Factory Default</b> option [R].
4	The following prompt appears:  <div style="background-color: #f0f0f0; padding: 5px; border: 1px solid #ccc;"> <pre>Are you sure you want to restore factory default settings? WARNING: Choosing Yes will restore factory defaults and then reboot..</pre> </div> Type 'y' to confirm. This erases user configurations and restores CDM-IP factory default configuration.
5	Proceed either to Sec. D.2.5 to perform the Managed Switch Mode configuration, or to Sect. D.2.6 to perform the Router Mode configuration.

## D.2.5 Configuring a Managed Switch Point-to-Point System

The procedures outlined in this section result in the configuration shown in **Figure D-3**.

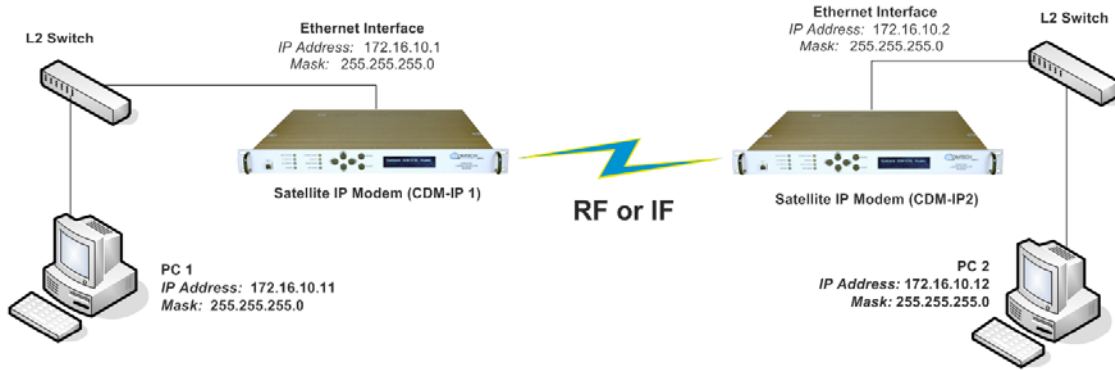

Figure D-3. Managed Switch Point-to-Point System Configuration

### D.2.5.1 Configure User PCs

Do these steps:

Step	Task
1	For User PC 1: <ul style="list-style-type: none"> <li>Set the IP Address to 172.16.10.11;</li> <li>Set the mask to 255.255.255.0.</li> </ul>
2	For User PC 2: <ul style="list-style-type: none"> <li>Set the IP Address to 172.16.10.12;</li> <li>Set the mask to 255.255.255.0.</li> </ul>
3	Reboot the PCs (if required).

### D.2.5.2 Configure CDM-IP 1, CDM-IP 2 – Set IP Address(es)

Do these steps (the applicable CLI “hot key” is shown in brackets [#]):

Step	Task
1	From the CLI Main Menu: Select the <b>Interface Configuration</b> submenu [ I ].
2	From the <b>Interface Configuration Menu</b> : Select the <b>Ethernet Interface</b> submenu [ E ].
3	Set <b>Ethernet IP Address</b> [ I ]: <ul style="list-style-type: none"> <li>Set CDM-IP 1 to 172.16.10.1</li> <li>Set CDM-IP 2 to 172.16.10.2</li> </ul>
4	Set the <b>Ethernet Subnet Prefix Length</b> [ M ] to 24.

All other parameters can be left at their factory default settings. At this point, the basic configuration is complete. You should now be able to use Windows Command-line to confirm that communications are active between the user PCs and the CDM-IP modems.

Do these steps to finish:

Step	Task
5	From User PC 1: <ul style="list-style-type: none"> <li>• Ping 172.16.10.1 (CDM-IP 1);</li> <li>• Ping 172.16.10.2 (CDM-IP 2);</li> <li>• Ping 172.16.10.12 (User PC 2).</li> </ul>
6	From User PC 2: <ul style="list-style-type: none"> <li>• Ping 172.16.10.2 (CDM-IP 2);</li> <li>• Ping 172.16.10.1 (CDM-IP 1);</li> <li>• Ping 172.16.10.11 (User PC 1).</li> </ul>



**Do not enable IF Loopback (or link the Tx to Rx by a BNC cable or satellite link) on a CDM-IP modem operating in Managed Switch Mode when connected to a LAN. In this configuration, Managed Switch Mode will resend all Layer 2 broadcast packets and cause a “broadcast storm” on the LAN.**

## D.2.6 Configuring a Router Mode Point-to-Point System

The procedures outlined in this section result in the configuration shown in **Figure D-4**.

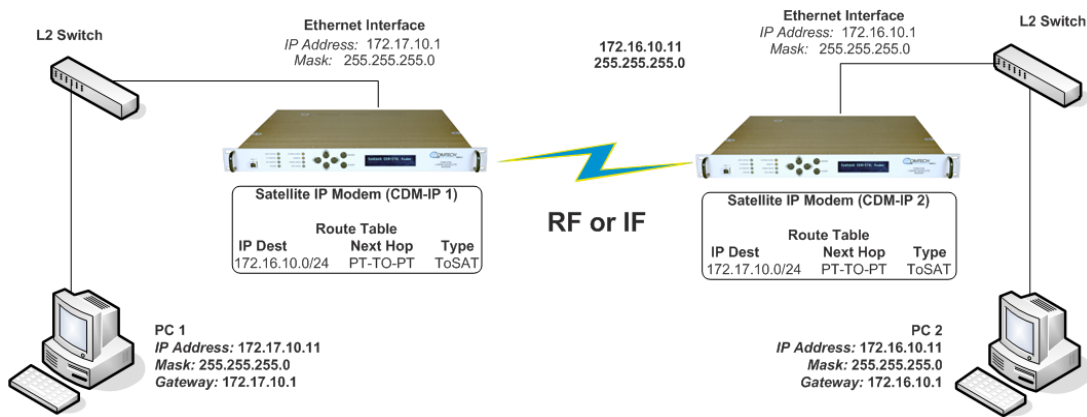

**Figure D-4. Router Mode Point-to-Point System Configuration**

### D.2.6.1 Configure User PCs

Do these steps:

Step	Task
1	For User PC 1: <ul style="list-style-type: none"> <li>Set the IP Address to 172.17.10.11;</li> <li>Set the mask to 255.255.255.0;</li> <li>Set the PC Gateway IP Address to 172.17.10.1.</li> </ul>
2	For User PC 2: <ul style="list-style-type: none"> <li>Set the IP Address to 172.16.10.11;</li> <li>Set the mask to 255.255.255.0;</li> <li>Set the PC Gateway IP Address to 172.16.10.1.</li> </ul>
3	Reboot the PCs (if required).

### D.2.6.2 Set CDM-IP Modems to Router Mode Operation

Do these steps on **CDM-IP 1** (the applicable CLI “hot key” is shown in brackets [#]):

Step	Task
1	From the CLI Main Menu: Select the <b>Administration [A]</b> submenu.
2	From the <b>Administration</b> menu: Select <b>CDM-IP Working Mode [C]</b> .
3	When the following prompt is displayed: <div style="background-color: #f0f0f0; padding: 5px; margin: 5px 0;"> <b>Changing Modem working mode requires system Reboot. Do you want to continue(Y/N)[Enter :No]</b> </div> <ul style="list-style-type: none"> <li>Confirm when prompted by typing ‘y’.</li> <li>Select <b>[3] Router-Point to Point</b> for IP SW version 1.6.x or earlier .</li> <li>Select <b>[4] Router-Point to Point</b> for IP SW version 1.7.x or later.</li> </ul>
4	Allow CDM-IP to reboot.

Both CDM-IP modems are now in Router-Point to Point Mode, which means that the CDM-IP modems will be on independent IP subnets and will require adding static routes to pass traffic between them.

### D.2.6.3 Set IP Address(es)

Do these steps (the applicable CLI “hot key” is shown in brackets [#]):

Step	Task
1	From the CLI Main Menu: Select the <b>Interface Configuration</b> submenu [I].
2	From the <b>Interface Configuration</b> Menu: Select <b>Ethernet Interface</b> submenu [E].
3	Set <b>Ethernet IP Address</b> [I]. <ul style="list-style-type: none"> <li>• CDM-IP 1 to 172.17.10.1</li> <li>• CDM-IP 2 to 172.16.10.1</li> </ul>
4	Set the Ethernet Subnet Prefix Length [M] to 24.

### D.2.6.4 Set Route Table Entries

First, do these steps on **CDM-IP 1** (the applicable CLI “hot key” is shown in brackets [#]):

Step	Task
1	From the CLI Main Menu: Select the <b>Route Table [R]</b> submenu.
2	Enter <b>1</b> to configure the first route.
3	Enter a suitable name.
4	Set <b>IP Address</b> to 172.16.10.0
5	Set <b>Number of Subnet Bits</b> to 24.
6	For <b>Interface to which route is destined to</b> <E-Ethernet S-Satellite Enter : S> select <b>S</b> .
7	The CDM-IP 1 Route Table should display the following:

Route Name	Dest IP/SNet Bits	Next Hop	MultiCast	State
Route001... [test	172.16.10.0/24	POINT-TO-POINT	N/A	toSat]

Next, do these steps on **CDM-IP 2** (the applicable CLI “hot key” is shown in brackets [#]):

Step	Task										
8	From <b>Transmitter Configuration Main Menu</b> submenu select <b>Route Table [R]</b> submenu.										
9	Enter <b>1</b> to configure the first route.										
10	Enter a suitable name										
11	Set <b>IP Address</b> to <b>172.17.10.0</b>										
12	Set <b>Number of Subnet Bits</b> to <b>24</b>										
13	For <b>Interface to which route is destined to</b> <E-Ethernet S-Satellite Enter : S> select <b>S</b>										
14	CDM-IP 2 Route Table should display the following:										
	<table border="1"> <thead> <tr> <th>Route Name</th> <th>Dest IP/SNet Bits</th> <th>Next Hop</th> <th>MultiCast</th> <th>State</th> </tr> </thead> <tbody> <tr> <td>Route001...[test</td> <td>172.17.10.0/24</td> <td>POINT-TO-POINT</td> <td>N/A</td> <td>toSat]</td> </tr> </tbody> </table>	Route Name	Dest IP/SNet Bits	Next Hop	MultiCast	State	Route001...[test	172.17.10.0/24	POINT-TO-POINT	N/A	toSat]
Route Name	Dest IP/SNet Bits	Next Hop	MultiCast	State							
Route001...[test	172.17.10.0/24	POINT-TO-POINT	N/A	toSat]							

At this point the basic configuration is complete and you should be able to:

- Ping **User PC 1** from **User PC 2**, and **User PC 2** from **User PC 1**;
- Ping **CDM-IP 2** from **User PC 1**, and **User PC 1** from **CDM-IP 2**;
- Pass any other data between the 2 PCs

Do these steps to finish:

Step	Task
15	From <b>PC1</b> : <ul style="list-style-type: none"> <li>• Ping 172.17.10.1 (CDM-IP 1)</li> <li>• Ping 172.16.10.1 (CDM-IP 2)</li> <li>• Ping 172.16.10.11 (PC 2)</li> </ul>
16	From <b>PC2</b> : <ul style="list-style-type: none"> <li>• Ping 172.16.10.1 (CDM-IP 2)</li> <li>• Ping 172.17.10.1 (CDM-IP 1)</li> <li>• Ping 172.17.10.11 (PC 1)</li> </ul>



## D.2.7 Troubleshooting High-Performance Packet Processor Operation

The CDM-IP comes with a variety of diagnostic tools to aid in identifying the traffic path going into and out of the CDM-IP modem. This troubleshooting section shows how to use some of these tools and also identifies several problem scenarios commonly encountered when first setting up two CDM-IP modems.

If following these troubleshooting steps fails to resolve the problem, contact Comtech EF Data Product Support for further assistance:

**+1.240.243.1880**  
**+1.866.472.3963 (toll free USA)**

### D.2.7.1 Managed Switch Mode Troubleshooting

Follow these troubleshooting steps if unable to successfully send traffic in Managed Switch Mode:

Scenario	Problem	Action
1	<p>No Ping response from the locally connected PC to the CDM-IP Ethernet port.</p> <p>ICMP response is: <b>Request timed out</b></p>	<p>A. Verify correct IP Address/subnet on PC and CDM-IP.</p> <p>B. Verify Ethernet connection – cables, PC, Layer 2 hub or switch, and CDM-IP should have Ethernet activity LED lit.</p> <p><b>Note:</b> A PC must be connected to the CDM-IP using a Layer 2 hub or switch, or an RJ45 crossover cable.</p> <p>When the CDM-IP Ethernet port senses an Ethernet connection, the CLI displays:</p> <p style="text-align: center;"><b>Ethernet Interface UP</b></p> <p>If the connection is broken, the CLI displays:</p> <p style="text-align: center;"><b>Ethernet Interface DOWN</b></p>
2	<p>No Ping response from the locally connected PC to the remote CDM-IP or remote PC.</p> <p>ICMP response is: <b>Request timed out</b></p>	<p>A. Verify both CDM-IP's are in Managed Switch Mode.</p> <p>B. Verify IF link between modems for proper settings and carrier quality (Rx signal level, <math>E_b/N_0</math>, etc.). It is possible that there is a spectrum inversion, particularly if you are using the CDM-IP with RF converter equipment. If this is the case, the signal level &amp; <math>E_b/N_0</math> may be OK, but no data will be received. To correct this, invert the Tx and Rx Spectrum on one of the CDM-IPs.</p> <p>C. Use Windows Command-line to send a constant ping from the User PC 1 'ping 172.16.10.2 -t' to User PC 2.</p> <p>From the CLI Main Menu: Select the <b>Operations and Maintenance</b> page [I], and then select the <b>Diagnostics</b> page [G].</p>

2 (cont.)

(2C cont.) Toggle [T] to *enable Dump Packets transmitted to Satellite Interface*. Verify that the pings are being transmitted by observing 1 packet on CLI every second. If not displayed, re-verify **User PC 1** and **CDM-IP 1** settings. Toggle [T] to *disable Dump Packets transmitted to Satellite Interface*.

D. Continue pinging from **User PC 1** to **User PC 2**.

From the **CDM-IP 2**:

From the CLI **Main Menu**:

Select the **Operations and Maintenance** page [I], and then select the **Diagnostics** page [G].

Toggle [R] to *enable Dump Packets received from Satellite Interface*. Verify that the pings are being received by observing 1 packet on CLI every second. If not displayed, re-verify **User PC 2** and **CDM-IP 2** settings. Toggle [R] to *disable Dump Packets received from Satellite Interface*.

**Note:** All pings transmitted will require a reply to be transmitted from the target host. Use the **Diagnostics** page 'Dump Packets' tools to isolate where packets are lost in the CDM-IP duplex paths. Also, always disable 'Dump Packets' before sending live traffic.

## D.2.7.2 Router Mode Troubleshooting

Follow these troubleshooting steps if unable to successfully send traffic in Router Mode.

Scenario	Problem	Action
1	<p>No Ping response from the locally connected PC to the CDM-IP Ethernet port.</p> <p>ICMP response is: <b>Request timed out</b></p>	<p><b>A.</b> Verify correct IP Address/subnet on PC and CDM-IP.</p> <p><b>B.</b> Verify Ethernet connection – cables, PC, Layer 2 hub or switch, and CDM-IP should have Ethernet activity LED lit.</p> <p><b>Note:</b> A PC must be connected to the CDM-IP using a Layer 2 hub or switch, or an RJ45 crossover cable.</p> <p>When the CDM-IP Ethernet port senses an Ethernet connection, the CLI displays:</p> <p style="text-align: center;"><b>Ethernet Interface UP</b></p> <p>If the connection is broken, the CLI displays:</p> <p style="text-align: center;"><b>Ethernet Interface DOWN</b></p>
2	<p>No Ping response from the locally connected PC to the remote CDM-IP or remote PC.</p> <p>ICMP response is: <b>Request timed out</b></p>	<p><b>A.</b> Verify both CDM-IPs are in <b>Router-Point to Point</b> mode.</p> <p><b>B.</b> Verify the PC's Gateways are set to local CDM-IP Address.</p> <p><b>C.</b> Verify IF link between modems for proper settings and carrier quality (Rx signal level, <math>E_b/N_0</math>, etc.).</p> <p>It is possible that there is a spectrum inversion, particularly if you are using the CDM-IP with RF converter equipment. If this is the case, the signal level and <math>E_b/N_0</math> may be OK, but no data will be received. To correct this, invert the Tx and Rx Spectrum on one of the CDM-IPs.</p>
3	<p>No Ping response from <b>User PC 1 to User PC 2</b> or vice versa.</p> <p>ICMP response is: <b>Reply from 172.XXX.10.1 - Destination net unreachable</b></p>	<p>Verify CDM-IP Route Tables are correct.</p>

## D.3 High-Performance Packet Processor – Typical Operational Setups

The CDM-570A/570AL-IP Satellite Modem (referred to hereafter as the **CDM-IP**) has several modes of operation. To determine the best mode of operation for the appropriate network topology and Ethernet traffic environment, this appendix illustrates typical operational setup examples for the CDM-IP.

### D.3.1.1 High-Performance Packet Processor Working Modes

Two Packet Processor Working Modes are available: **Managed Switch Mode** (formerly easyConnect™) and **Router Mode**.

#### D.3.1.1.1 Working Modes – HDLC Encapsulation



**COMPATIBILITY NOTE – HDLC Encapsulation is available only in CDM-570/L or CDD-564/L IP Module V1/MPP-50 Firmware Ver. 1.6.# and earlier, and IP Module V2/MPP-70 Firmware Ver. 2.1.# and earlier.**

Three HDLC Addressing Modes serve to minimize the HDLC overhead transmitted over the satellite based upon the size of their network. These modes are:

- Point-to-Point
- Small Network
- Large Network

In order to optimize Comtech EF Data IP modems in the network (based upon Network Topology and Ethernet Traffic requirements), note the following:

- In **Router/Point-to-Point Mode**, no HDLC address is transmitted.
- **Router/Small Network Mode** transmits 1 byte.
- **Router/Large Network Mode** transmits 2 bytes as part of the HDLC header for each packet; non-IP traffic is not supported in Router Mode.



**The Working Mode and HDLC Addressing Mode of the Comtech EF Data IP modems must be identical to pass traffic between modems.**

**Changing the Working Mode or HDLC Addressing Mode of the IP modem requires the Packet Processor to be rebooted. Before selecting a different mode, the Packet Processor issues a notice that the mode change will require a reboot.**

Working Mode HDLC Addressing Mode	Network Topology	Ethernet Traffic
Managed Switch Mode Point-to-Point	Point-to-Point only Both sites on same LAN subnet	IP v4 and/or non-IP
Router Mode Point-to-Point	Point-to-Point only Both sites on different LAN subnet	IP v4 only
Router Mode	Point-to-Point or Point-to-MultiPoint (up to 254 sites)	IP v4 only
Small Network	All sites on different LAN subnet	

Working Mode HDLC Addressing Mode	Network Topology	Ethernet Traffic
Router Mode	Point-to-Point or Point-to-MultiPoint (up to 32766 sites)	IP v4 only
Large Network	All sites on different LAN subnet	
Router + Brouter	Point-to-Point – Large Network	IP v4 + VLAN

**Feature Support** – The Packet Processor has several standard and optional features to further optimize security, performance and efficiency. These features are supported in the two working modes as follows:

Feature	Managed Switch Mode	Router Mode
HDLC Addressing Mode	Point-to-Point Only	Point-to-Point, Small Network, Large Network (can be Point-to-MultiPoint)
10/100 BaseT Operation	10 or 100 BaseT Ethernet Half or Full Duplex	10 or 100 BaseT Ethernet Half or Full Duplex
Access Lists	None	Four Clients by IP or IP Subnet
Quality of Service	Min/Max; Max/Priority; DiffServ	Min/Max; Max/Priority; DiffServ
Header Compression	Yes – Layer 2 is always compression. Applied to all Layers 3, 4, and 5 traffic when enabled	Yes – applied on a per route basis
Payload Compression	Yes - applied to all traffic when enabled	Yes – applied on a per route basis
Multicast	Select either all or no Multicast, Uplink or Downlink	All or specific Multicast streams, Uplink or Downlink
IGMP	No	Yes
Remote upgrade by FTP	Yes	Yes

### D.3.1.1.2 Managed Switch Mode



Managed Switch Mode will automatically use Layer 2 Header Compression, even if the Header Compression option has not been purchased. Because of this, some of the initial traffic sent between two devices will not be received over the satellite until a full header is transmitted.

For example, the default Header Compression Refresh Rate is 50 packets. If a ping is sent over the satellite, it will time out until the full Header packet is sent.

The Header Compression Refresh Rate on the Administration Menu can be reduced to minimize the amount of traffic lost when traffic is first sent between two devices. Once communication between two devices has been established, both modems will be able to receive all traffic, unless one modem is power-cycled or reset.

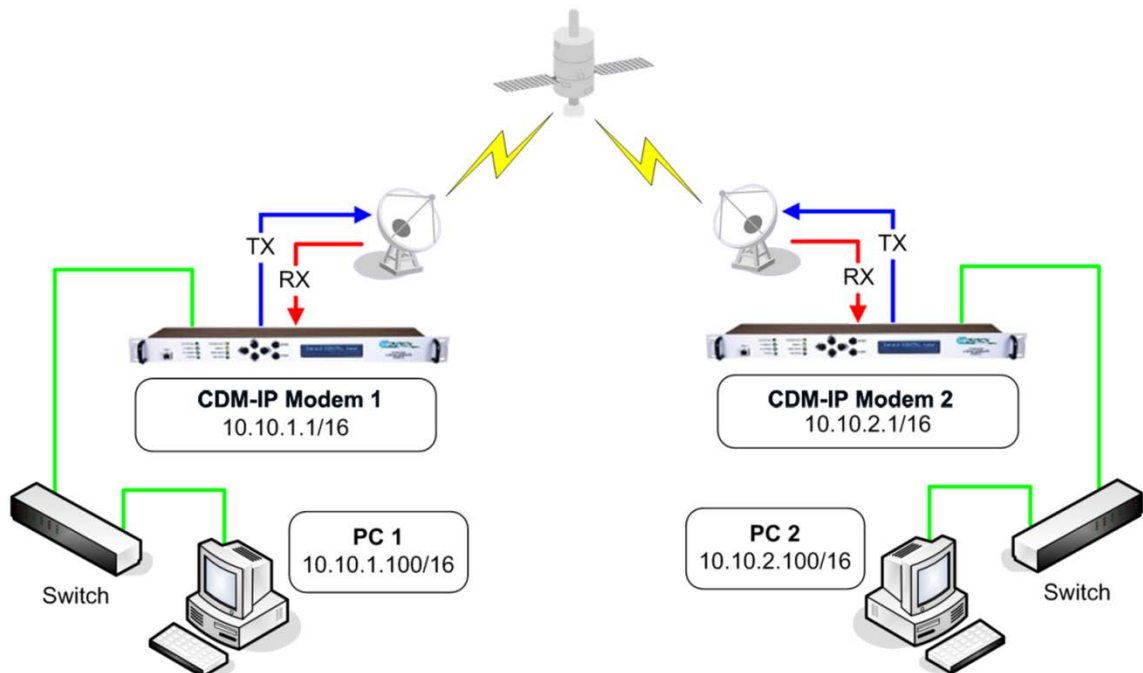

**Figure D-5. Managed Switch Mode**

Managed Switch Mode is the default working mode for the optional Packet Processor. This mode allows the modem to be set up with minimal configuration (no specific routes need to be configured). Managed Switch only operates in Point-to-Point Mode, meaning that it is communicating with only one other CDM-IP. In this mode, the Packet Processor is acting as a “smart wire” over a satellite link between two CDM-IPs. This allows the optional Packet Processor to simultaneously forward IP traffic and non-IP traffic such as IPX.

**Figure D-5** shows a 256 kbps Point-to-Point duplex link in Managed Switch Mode. Note that both sides of the link are on the same IP subnet – 10.10.0.0/16. There are no routes or HDLC addresses to configure. When the system is powered-up, all packets from each subnet (local and remote) will be sent over the satellite interface. Each CDM-IP learns which devices are attached to their local Ethernet interfaces and will only send packets over the satellite that are not destined for the locally attached devices.

### D.3.1.1.3 Router Modes

#### D.3.1.1.3.1 Router Mode – Point-to-Point

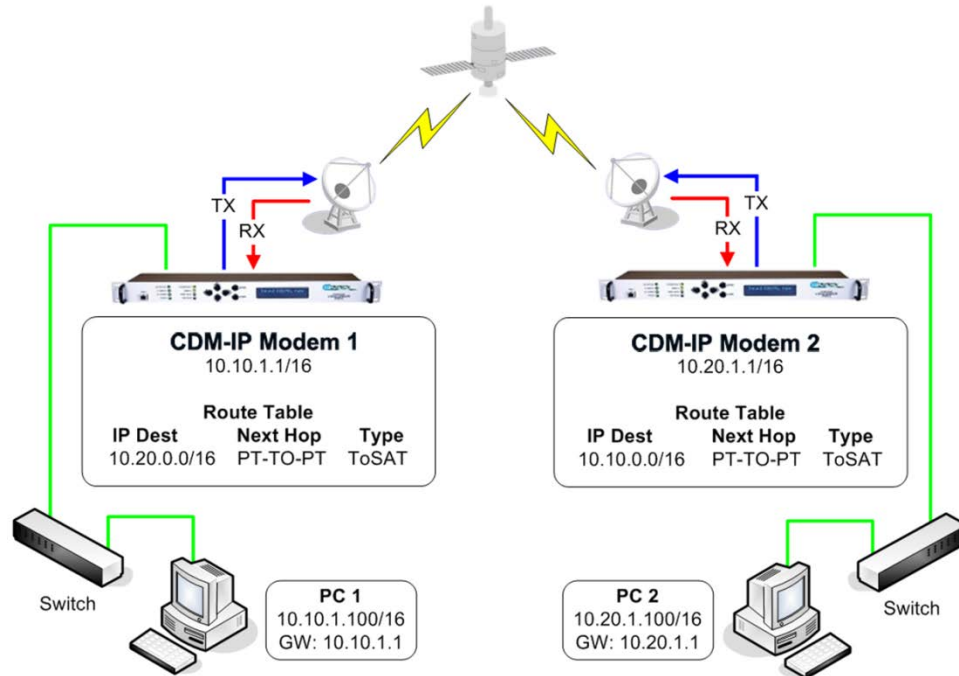

**Figure D-6. Router Point-to-Point Working Mode**

Figure D-6 shows a 256 kbps Point-to-Point duplex link in Router Mode. For this case:

- Each side of the link has different IP subnets – 10.10.0.0/16 and 10.20.0.0/16.
- Each CDM-IP has a static route defined for the distant CDM-IP subnet.
- The Next Hop is automatically defined as Point-to-Point, and there are no HDLC addresses to configure; all that is required to send traffic between the PCs on each subnet is to define the local CDM-IP as the PC default gateway.
- The CDM-IPs will only pass traffic over the satellite link by the ToSat routes configured in the Route Table.

### D.3.1.1.3.2 Router Mode – Point-to-MultiPoint

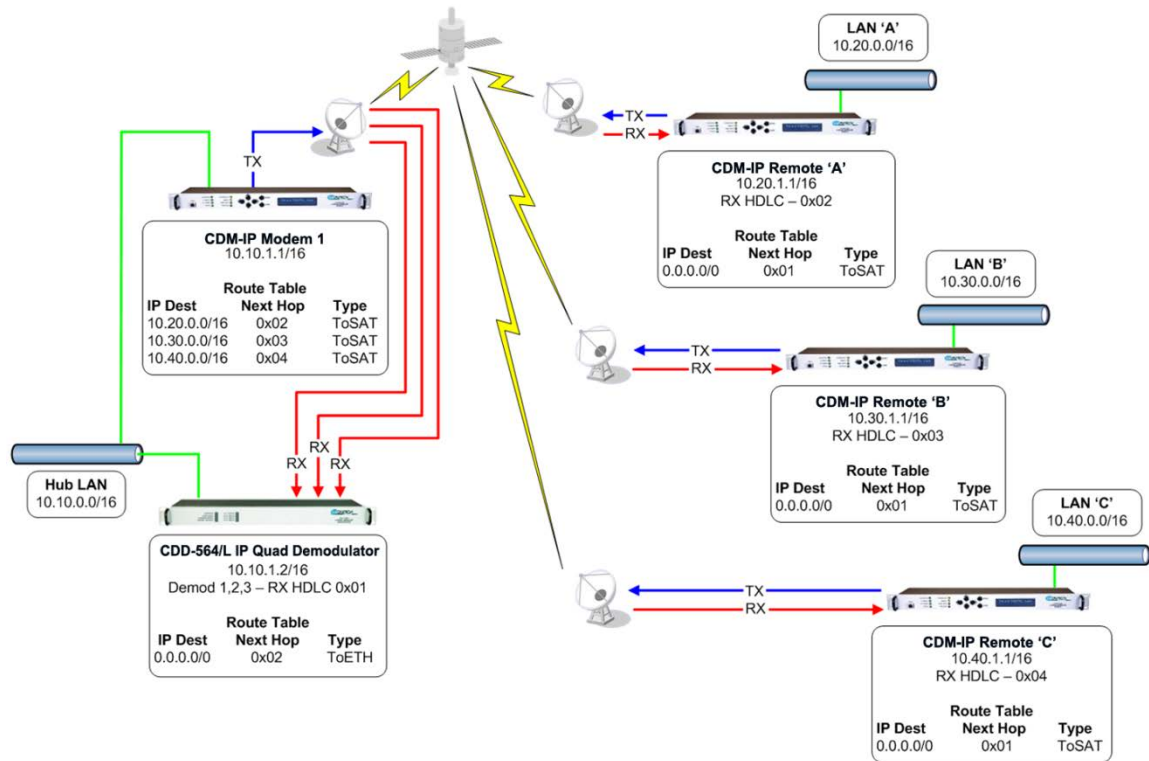

Figure D-7. Router Point-to-MultiPoint Working Mode w/HDLC



**Router Point-to-MultiPoint Working Mode with HDLC Addressing only applies to CDM-IPs and CDD-564/L IPs operating with CDM-IP Modem(s).**

Figure D-7 shows a Point-to-MultiPoint configuration (also referred to as a “STAR Network”). The Hub CDM-IP is transmitting a common 2.048 Mbps link to THREE remote CDM-IPs. All three remote CDM-IPs are transmitting a 256 kbps link back to the Hub CDD-564/L IP Quad Demodulator.

Since this is a Point-to-MultiPoint configuration, HDLC addressing is used so that the traffic not intended for a particular destination can be filtered. For Unicast traffic, it is best to associate a unique HDLC address for each site in the network. For this case:

- The Hub Site is HDLC 0x01;
- Remote 'A' is HDLC 0x02;
- Remote 'B' is 0x03;
- Remote 'C' is 0x04.



Each CDM-IP would select the HDLC address associated with its site as a RX HDLC Address. Therefore, for this case:

- The Hub CDD-564/L Demodulators 1, 2, and 3 would have 0x01 as the first RX HDLC Address;
- Remote 'A' CDM-IP would have 0x02;
- Remote 'B' CDM-IP would have 0x03;
- Remote 'C' CDM-IP would have 0x04.

The Hub CDM-IP 1 has static routes defined for each of the remote CDM-IP subnets with the Next Hop HDLC address being the HDLC address associated with the remote site. All three remote CDM-IP modems have default routes to the satellite with the Next Hop HDLC address being 0x01. The Hub CDD-564/L Demodulator has a default route (ToEth) to the Hub CDM-IP modem because all outbound traffic will go through the CDM-IP modem.

Additional remote sites can be added through a dedicated demodulator at the hub for each remote.

### D.3.1.1.3.3 Router Mode (Brouter Enabled) – Point-to-MultiPoint with VLAN Matching Filters



1. **COMPATIBILITY NOTE – Brouter Point-to-MultiPoint Mode with VLAN Matching Filters applies only to CDM-IPs and CDD-564/Ls. The entire network must be configured to operate in the same mode – either entirely configured to use VLAN Matching Filters, or entirely configured with Filtering Disabled.**
2. **As the CDM-570A/570AL-IP can process six times (6X) the number of packets more than the CDM-570/L, you may not need to use Brouter Mode.**

In previous network configurations, ALL remote CDM-IP modems were required to process all VLAN packets, and then decide whether to forward or discard. In some user applications, this could result in very high processor utilization numbers and possibly result in 'overdriving' the processor.

The Brouter (Bridged + Router Traffic) Working Mode with VLAN Filtering is a special mode of operation where VLAN traffic is bridged and non-VLAN traffic is routed using static route table information. This allows the user to optimally configure the networks to ensure that the remote modem's Packet Processor is not 'overdriven'.

### D.3.1.1.3.3.1 Brouter Mode with VLAN Filtering Configuration



1. **Use of the VLAN Filtering feature requires operation in Large Network Mode to support the full 12-bit VLAN IDs field.**
2. **A maximum of 10 VLAN ID matches are supported. Unused VLAN ID match fields must be set to values that DO NOT match any network VLAN IDs.**

To configure Brouter Working Mode in a Point-To-MultiPoint network using VLAN Filtering with CDM-IP modems and the CDD-564/L IP Quad Demodulator:

- At the Hub side, the only new configuration item required for the CDM-IP Hub Modem is to enable VLAN Filtering. When enabled, the CDM-IP Hub Modem will transfer the first VLAN ID to the 2-byte HDLC field.
- At each CDM-IP Remote Modem, VLAN Filtering must be enabled and the appropriate VLAN IDs entered into the Match table.
- 
- **Figure D-8** shows a network comprised of a managed Hub Site and three Remote sites. In this service, Remote Sites 'A' and 'B' share a common corporate service (Service 'B' Network) – a typical requirement in the oil and gas industry. All three sites employ a Shared Voice Service. Sites 'B' and 'C' employ a Shared Internet Service. Each site additionally has services (VLAN networks) that are exclusive to that site. The services provided in this network are defined as follows:

Service Description	VLAN ID	Sites in Service
Shared Voice Services	0911	A, B, C
Shared Internet Services	1111	B, C
Management Services	1200	A, B, C
Corporate Network 'A'	0080	A
Corporate Network 'B'	0081	A, B
Corporate Network 'C'	0090	B
Corporate Network 'D'	0100	C
Corporate Network 'E'	0101	C

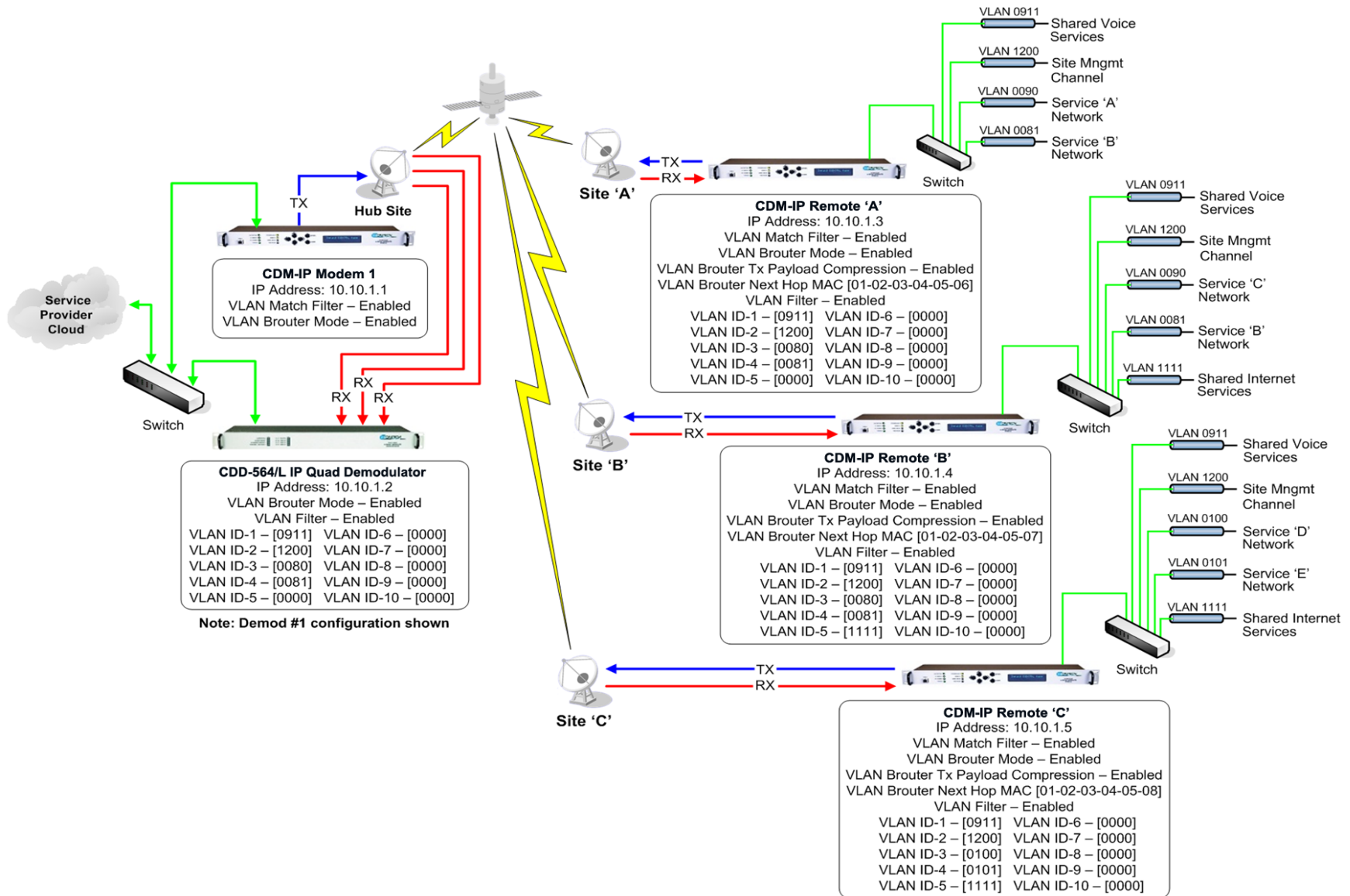

Figure D-8. Brouter Point-to-MultiPoint Working Mode w/VLAN Filtering

BLANK PAGE

Each Comtech EF Data product, as depicted in this network example, is configured as follows:

Hub Site – CDM-IP Modem

IP Address: 10.10.1.1  
VLAN Match Filter – Enabled

```

COM1:38400baud - Tera Term VT
File Edit Setup Control Window Help

Brouter Configuration
ULAN Brouter Mode.....[Enabled].....B
ULAN Brouter Tx Payload Compression...[Enabled]...P
ULAN Brouter Next Hop MAC.....[0D-EF-ED-00-00-04]...N
ULAN Brouter Remote Mode Enable.....[Disabled]...R
ULAN Filtering.....[Enabled]...F
ULAN ID 1.....[0000]...1
ULAN ID 2.....[0000]...2
ULAN ID 3.....[0000]...3
ULAN ID 4.....[0000]...4
ULAN ID 5.....[0000]...5
ULAN ID 6.....[0000]...6
ULAN ID 7.....[0000]...7
ULAN ID 8.....[0000]...8
ULAN ID 9.....[0000]...9
ULAN ID 10.....[0000]...A

Save Parameters to permanent storage.....S
Exit.....X
    
```

Hub Site – CDD-564/L Quad Demodulator ((Demodulator #1 shown))

IP Address: 10.10.1.2  
VLAN Match Filter – Enabled

```

COM2:38400baud - Tera Term VT
File Edit Setup Control Window Help

Brouter Configuration
ULAN Brouter Mode.....[Enabled].....B
ULAN Brouter Next Hop MAC.....[0D-EF-ED-00-00-04]...N
ULAN Brouter Remote Mode Enable.....[Disabled]...R
ULAN Filtering.....[Enabled]...F
ULAN ID 1.....[0911]...1
ULAN ID 2.....[1200]...2
ULAN ID 3.....[0000]...3
ULAN ID 4.....[0001]...4
ULAN ID 5.....[0000]...5
ULAN ID 6.....[0000]...6
ULAN ID 7.....[0000]...7
ULAN ID 8.....[0000]...8
ULAN ID 9.....[0000]...9
ULAN ID 10.....[0000]...A

Demod Select.....[1]...Z
Save Parameters to permanent storage.....S
Exit.....X
    
```

Remote Site 'A' – CDM-IP Remote Modem 'A'

IP Address: 10.10.1.3  
VLAN Match Filter – Enabled

```

COM1:38400baud - Tera Term VT
File Edit Setup Control Window Help

Brouter Configuration
ULAN Brouter Mode.....[Enabled].....B
ULAN Brouter Tx Payload Compression...[Enabled]...P
ULAN Brouter Next Hop MAC.....[0D-EF-ED-00-00-00]...N
ULAN Brouter Remote Mode Enable.....[Enabled]...R
ULAN Filtering.....[Enabled]...F
ULAN ID 1.....[0911]...1
ULAN ID 2.....[1200]...2
ULAN ID 3.....[0000]...3
ULAN ID 4.....[0001]...4
ULAN ID 5.....[0000]...5
ULAN ID 6.....[0000]...6
ULAN ID 7.....[0000]...7
ULAN ID 8.....[0000]...8
ULAN ID 9.....[0000]...9
ULAN ID 10.....[0000]...A

Save Parameters to permanent storage.....S
Exit.....X
    
```

Remote Site 'B' – CDM-IP Remote Modem 'B'

IP Address: 10.10.1.4  
VLAN Match Filter – Enabled

```

COM1:38400baud - Tera Term VT
File Edit Setup Control Window Help

      Brouter Configuration
ULAN Brouter Mode.....[Enabled].....B
ULAN Brouter Tx Payload Compression..[Enabled].....P
ULAN Brouter Next Hop MAC.....[0D-EF-ED-00-00-01].....M
ULAN Brouter Remote Mode Enable.....[Enabled].....R
ULAN Filtering.....[Enabled].....F
ULAN ID 1.....[0911].....1
ULAN ID 2.....[1200].....2
ULAN ID 3.....[0090].....3
ULAN ID 4.....[0081].....4
ULAN ID 5.....[1111].....5
ULAN ID 6.....[0000].....6
ULAN ID 7.....[0000].....7
ULAN ID 8.....[0000].....8
ULAN ID 9.....[0000].....9
ULAN ID 10.....[0000].....A

Save Parameters to permanent storage.....S
Exit.....X
    
```

Remote Site 'C' – CDM-IP Remote Modem 'C'

IP Address: 10.10.1.5  
VLAN Match Filter – Enabled

```

COM1:38400baud - Tera Term VT
File Edit Setup Control Window Help

      Brouter Configuration
ULAN Brouter Mode.....[Enabled].....B
ULAN Brouter Tx Payload Compression..[Enabled].....P
ULAN Brouter Next Hop MAC.....[0D-EF-ED-00-00-02].....M
ULAN Brouter Remote Mode Enable.....[Enabled].....R
ULAN Filtering.....[Enabled].....F
ULAN ID 1.....[0911].....1
ULAN ID 2.....[1200].....2
ULAN ID 3.....[0100].....3
ULAN ID 4.....[0101].....4
ULAN ID 5.....[1111].....5
ULAN ID 6.....[0000].....6
ULAN ID 7.....[0000].....7
ULAN ID 8.....[0000].....8
ULAN ID 9.....[0000].....9
ULAN ID 10.....[0000].....A

Save Parameters to permanent storage.....S
Exit.....X
    
```

Note that, in this configuration, the management of the CDM-IP modems can either be included in VLAN 1200 or left outside of all VLANs, since all remotes process all non-VLAN traffic.



**Chapter 9. OPTIONAL PACKET PROCESSOR – SERIAL/TELNET CLI OPERATION**

# Appendix E. AUPC (AUTOMATIC UPLINK POWER CONTROL)

---

## E.1 Overview



**WARNING! YOU MUST OBTAIN PERMISSION FROM THE SATELLITE OPERATOR TO USE THIS FEATURE. IMPROPER USE OF THIS FEATURE COULD RESULT IN A TRANSMITTING TERMINAL SERIOUSLY EXCEEDING ITS ALLOCATED FLUX DENSITY ON THE OPERATOR'S SATELLITE. THIS COULD PRODUCE INTERFERENCE TO OTHER CARRIERS, AND COULD CAUSE TRANSPONDER SATURATION PROBLEMS.**

The Automatic Uplink Power Control (AUPC) feature permits a local CDM-570A/570AL to adjust its own output power level in order to attempt to maintain the Eb/No at the remote CDM-570A/570AL. To accomplish this, you must use the EDMAC or EDMAC-2 framing type.

The remote modem constantly sends back information about the demodulator Eb/No using reserved bytes in the overhead structure. The local modem then compares this value of Eb/No with a pre-defined target value. If the Remote Eb/No is below the target, the local modem will increase its output power, creating a closed-loop feedback system over the satellite link. A particularly attractive benefit of this feature is that, whenever framed operation is selected, the remote demodulator's Eb/No can be viewed from the front panel display of the local modem. Note that both EDMAC and AUPC can be used simultaneously with either framing type.

There are several important parameters associated with this mode of operation. You must understand how the AUPC feature works, and what the implications are for setting these parameters.

---

## E.2 Setting AUPC Parameters

You must enable EDMAC framing. Do these steps:

1. Use the **SELECT: Config → Frame → EDMAC** or **EDMAC-2** menu to select **EDMAC+AUPC** framing. You may then define the unit as an EDMAC **Master** or **Slave**.
2. Verify that the remote modem also has EDMAC framing enabled.
3. Set the nominal output power of the modem: Use the **SELECT: Config → Tx → Pwr** (Power) menu to select **MANUAL** mode, and then edit the displayed Tx output power level.
4. Select **AUPC** as the operating mode. At this point, you are prompted to define four key parameters: **Target-Eb/No**, **Max-Range**, **Alarm**, and **DemodUnlock**.

## E.2.1 Target-Eb/No

Set the Eb/No values that you need to keep constant at the remote modem. Do these steps:

1. Enter a minimum value of 0.0 dB. If the Eb/No falls below this value, the AUPC control will increase the Tx output power, but will never exceed the value determined by the parameter **Max-Range**.
2. Enter a maximum value of 14.9 dB. If the Eb/No exceeds this value, the AUPC control will reduce the Tx output power, but will never drop below the nominal value set.
  - The default value is 3.0 dB.
  - The resolution is 0.1 dB.

## E.2.2 Max-Range

Set how much the modem is permitted to increase the output level, under AUPC control. Do these steps:

1. Enter a minimum value of 0 dB.
2. Enter a maximum value of 9 dB.
  - The default value is 1 dB.
  - The resolution is 1 dB.

## E.2.3 Alarm

Set the modem behavior when the maximum power limit is reached while under AUPC control. The two choices are:

- None (no action) – default setting.
- TxALARM (generate a Tx alarm).



## E.2.4 DemodUnlock

Set the action the modem will take if the remote demodulator loses lock. The two choices are:

- **Nom-Pwr** reduces the Tx Output Power to the nominal value – default setting.
- **Max-Pwr** increases the Tx Output Power to the maximum value permitted by the parameter Max-Range.



**If the local demod loses lock, then the modem automatically moves its output power to the nominal value.**

---

## E.3 Compensation Rate

As with any closed-loop control system, you must choose loop parameters that ensure stability at all times. Several features ensure that the AUPC system does overshoot, or oscillate:

- First, corrections for which the output power can be made are fixed at the rate of once every four seconds. This takes into account the round trip delay over the satellite link, the time taken for a power change to be reflected in the remote demodulator's value of Eb/No, and other processing delays in the modems.
- Second, if the comparison of actual and target Eb/No yields a result that requires a change in output power, to avoid the possibility of overshoot the first correction made will be at 80% of the calculated step. Subsequent corrections are made until the difference is less than 0.5 dB. At this point, the output power is only changed in increments of 0.1 dB to avoid 'hunting' around the correct set point.

---

## E.4 Monitoring



**CAUTION – Comtech EF Data strongly cautions against the use of large values of permitted power level increase under AUPC control. Users should consider using the absolute minimum range necessary to improve rain-fade margin.**

The remote demodulator's value of Eb/No can be monitored at all times, either from the front panel (**SELECT: Monitor → AUPC**) or via the remote control interface. The resolution of the reading is 0.2 dB. For all values greater than or equal to 16 dB, a value of 16.0 dB will be displayed. As long as framing is enabled, the value will still be available, even though AUPC may be disabled.

The current value of Tx power increase is also displayed. If EDMAC framing is enabled but AUPC is disabled, this will indicate 0.0 dB. This value is also available via the remote control interface.



# Appendix F. CLOCKING MODES

---

## F.1 Overview

When dealing with satellite modems, the subject of clocking can be a complex issue. This chapter describes the various clocking options that are available with the CDM-570A/570AL.

The CDM-570A/570AL provides two fundamentally different interfaces:

- Synchronous clock and data interfaces (EIA-422, V.35, etc.) that permit great flexibility concerning the source and direction of clocks. These cause the most confusion.
- G.703 interfaces, in which the clock and data are combined into a single signal (and are referred to as self-clocking). In their basic form, these are less flexible and therefore easier to understand. However, when used with Drop and Insert operation, the subject again becomes more complex.

---

## F.2 Transmit Clocking

There are four transmit clocking modes in the CDM-570A/570AL. **Figure F-1** illustrates these modes. Note that while EIA-422/449 signal mnemonics are used in this figure, the description applies equally to V.35 and synchronous EIA-232

### F.2.1 Internal Clock

In this mode, the modem, assumed always to be the DCE, supplies the clock to the DTE. (The EIA-422/449 name for this signal is Send Timing, or **ST**.) The DTE then clocks from this source, and gives the modem transmit data (Send Data, or **SD**) that is synchronous with this clock. It is optional whether the DTE also returns the clock (Terminal Timing, or **TT**) – the modem can accept it if it is present, but uses ST if it is not. At rates above 2 Mbps, Comtech EF Data highly recommends that you return TT to ensure the correct clock/data relationship.

**G.703:** The internal clock mode does not apply; the clock is always recovered from the incoming signal, and the modem locks its modulator clocks to this.

**G.703 Clock extension:** This is a special case of Internal Tx Clock, where the internal clock generator is perfectly locked to an externally applied G.703 (T1 or E1) signal. See Section F.1 for detailed information.

## F.2.2 TX Terrestrial

In this mode, the modem expects to see the DTE provide the clock so that it can phase-lock its internal circuits. In this case, the modem does not provide any signal on ST, but instead requires a clock signal on TT that is synchronous with the data. If no clock is present, an alarm will be generated and the modem will substitute its internal clock.

**G.703:** This is the 'natural' clock mode.

## F.2.3 RX Loop-Timed, RX=TX

In certain circumstances, a terminal at the distant-end of a satellite link may be required to provide a clock to the DTE equipment that is locked to the receive satellite signal. This is similar to Internal Clock mode in that the modem will source ST to the DTE, but now the timing is derived from the demodulator. The DTE then clocks from this source and gives the modem transmit data (SD) that is synchronous with this clock. It is optional whether the DTE also returns the clock (TT) – the modem can accept it, if it is present, but uses ST if it is not. If the demodulator loses lock, the modem's internal clock will be substituted, so an accurate and stable clock is present on ST rather than a clock that may jitter and wander in a random fashion.

**G.703:** Does not apply.

## F.2.4 RX Loop-Timed, RX<>TX (Asymmetric Loop Timing)

The CDM-570A/570AL incorporates circuitry that permits loop timing when the TX and RX data rates are not the same. In this case, the clock frequency appearing at ST will be whatever the TX data rate is programmed to, but will be phase-locked to the demodulator's receive symbol clock. In all other respects, the operation is the same as for 'standard' loop timing.

**G.703:** Does not apply.

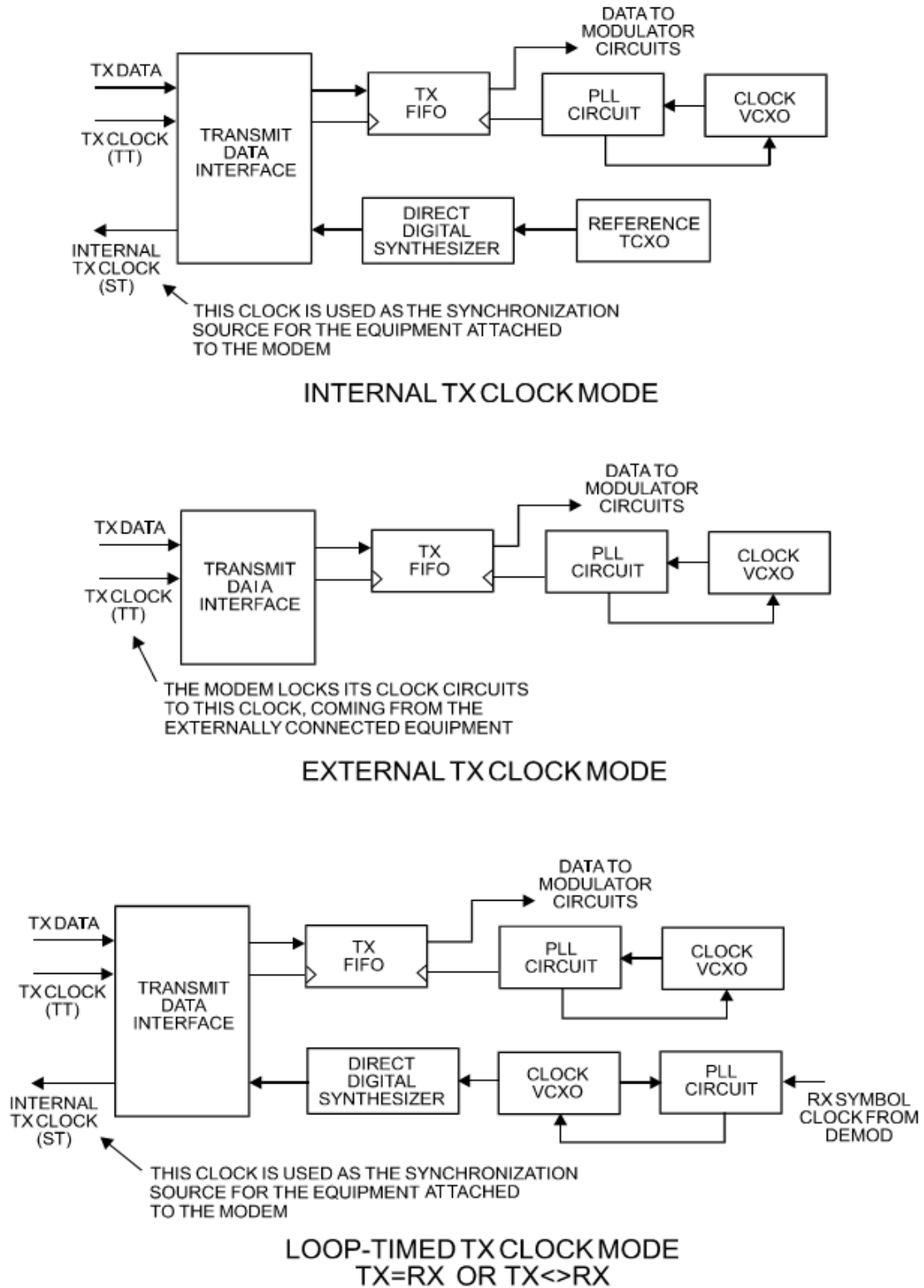

Figure F-1. TX Clock Modes

---

## F.3 Receive Clocking

There are three receive clocking modes in the CDM-570A/570AL: Buffer Disabled (RX Satellite), Buffer Enabled (TX=RX), and Buffer Enabled (RX< >TX). An additional setting used only for Drop and Insert is described in further detail later in this chapter. **Figure F-2** provides a graphic depiction of these modes.

### F.3.1 Buffer Disabled (RX Satellite)

When the buffer is disabled, the receive clock (Receive Timing, or RT) is derived directly from the demodulator, and will therefore be subject to plesiochronous and Doppler offsets. This may be acceptable in certain instances. There is still a minimum buffer in use to de-jitter the effects of removing overhead framing.

**G.703:** Applicable.

### F.3.2 Buffer Enabled, TX=RX

In this instance, it is required that the buffer be enabled, so that the clock and data appearing on Receive Timing (RT) and Receive Data (RD) are synchronous with the transmit clock or the internal (SCT) clock. This is a relatively simple case, as the output clock for the buffer is derived directly from ST, TT, or the external source.

**G.703:** Applicable.

### F.3.3 Buffer Enabled, RX<>TX

This is an uncommon case, where the receive data rate does not equal the transmit or external reference. The modem will generate a phase-locked buffer output clock that uses the selected reference, regardless of its frequency in relation to the receive data rate.

**G.703:** Applicable.

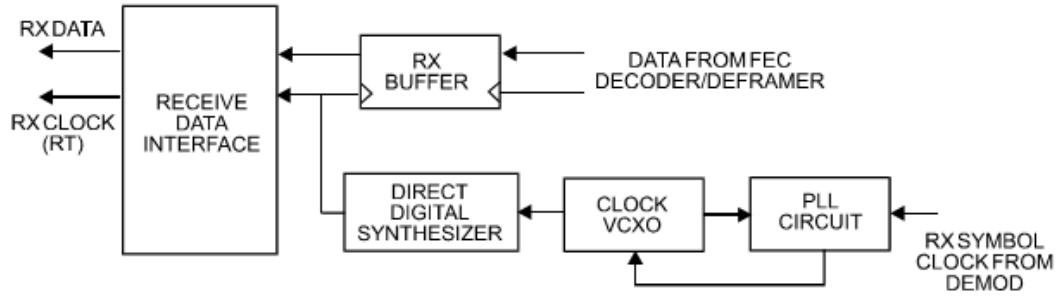

**BUFFER DISABLE CLOCK MODE**

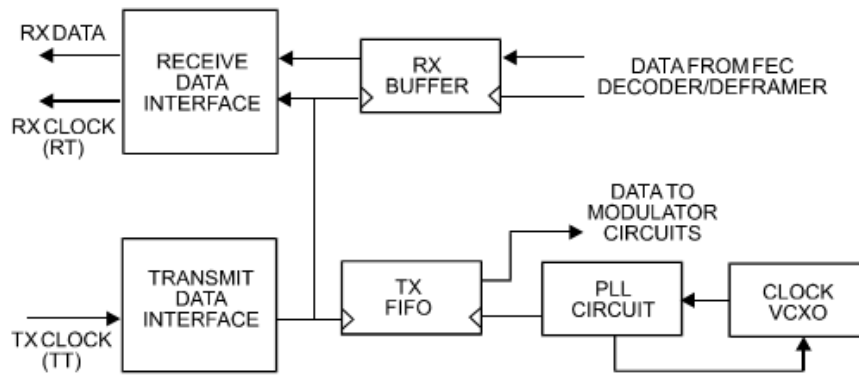

**BUFFER ENABLE  
TX = RX CLOCK MODE**

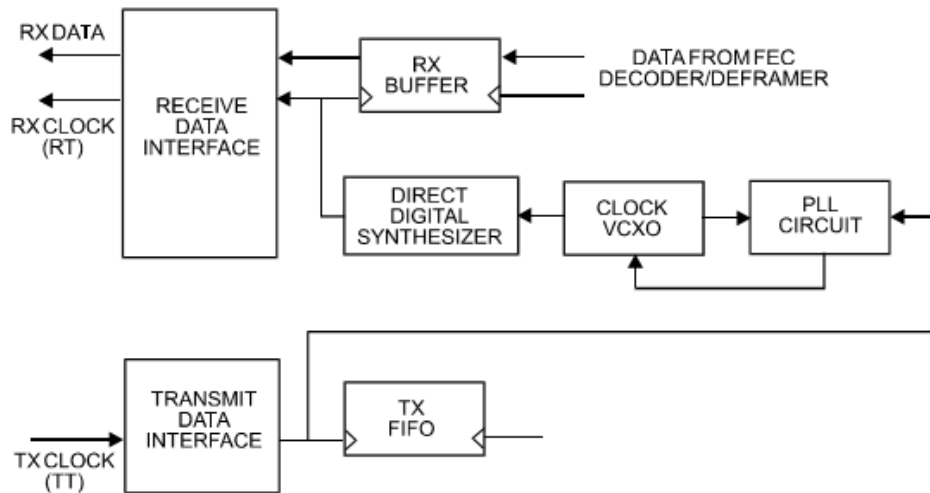

**BUFFER ENABLE  
TX  $\leftrightarrow$  RX CLOCK MODE**

**Figure F-2. RX Clock Modes**

---

## F.4 X.21 Notes

The central feature of X.21 is that the DCE supplies the clock for both directions. Therefore, the first requirement is that TX and RX data rates are the same. Because the DCE doesn't get an input clock moving in the same direction as its input data, the several nanoseconds of delay through long cables and the modem's data transceivers can cause the clock phase to change relative to the data. This is why X.21 is not recommended above 2048 kbps.

If **Modem = DCE** (normal assumption), then X.21 mode is just a matter of ignoring ST and TT and, instead, using RT to run both directions. Using the clock settings **TX Clk = Loop** and **RX Buffer Clk = RX** assumes that the desired timing is coming from the far-end modem. The modem's ST is forced to be a copy of RT, because the latter assumes use by the terrestrial DTE to drive SD data into the modem.

If, instead, the local modem supplies the timing, the clock settings should be **TX Clk = Int** and **RX Buffer Clk = TX or Int**. These settings instead force RT to be a copy of ST. In either case, it is SD that has an uncertain phase relationship to the clock due to round-trip delays, so the modem's TX clock invert feature may be necessary to avoid clocking in SD on its transitions.

If **Modem = DTE**, then ST and RT are ignored, and TT from the terrestrial DCE is used. The correct modem settings are **TX Clk = TT** and **RX Buffer Clk = TX**. These settings force RT (which drives out the modem's RD) to be a copy of TT. It is now RD that has an uncertain phase relationship to the clock, so the modem's RX clock invert may be necessary to please the terrestrial DCE.

---

## F.5 G.703 Clock Extension

There are some applications where it becomes necessary, at the distant end of a satellite link, to provide a high-stability G.703 timing reference for timing equipment connected to the modem. For example, in cellular backhaul applications, the BTS equipment may require such a reference **even though the satellite link itself may be operating at a data rate other than 1.544 Mbps or 2.048 Mbps**. This is sometimes accomplished by adding a specialized GPS receiver at the distant end, which then provides the G.703 synchronizing signal. However, with the G.703 clock extension mode this may become unnecessary, as the CDM-570A/570AL – operating at either end of the link, where the local modem has access to a high-stability G.703 signal – can provide an almost perfect copy of this signal at the distant end. The presence of Doppler shift on the link is the only factor affecting the overall accuracy. If Doppler shift were not present, the copy of the clock would be perfect.

This is accomplished by the use of a novel frequency synthesis and phase locking scheme. This feature of the CDM-570A/570AL permits the distant end to generate a G.703 synchronizing signal that, depending on a sufficiently accurate local reference, has short term accuracy to within parts in  $10^{-8}$ , and is solely dependent on link Doppler shift.

The subsections and figures that follow illustrate three possible G.703 clock extension modes. Details of how to set up the modems for these various operating modes are given in **Chapter 6. FRONT PANEL OPERATION**.



## F.5.1 Clock Extension Mode 1

**Figure F-3** shows Clock Extension Mode 1. The local modem is assumed to be operating on INTERNAL clock. A T1 or E1 G.703 signal is applied to the rear panel connector of the modem, where the clock is recovered.



**The G.703 signal is not intended to convey data – its function is only to provide a synchronizing clock. The data is transferred using the EIA-530/V.35 serial interface.**

The internal clock reference generator locks – in both frequency and phase – to this recovered clock, and a special synthesizer generates an ST clock of ANY ARBITRARY FREQUENCY over the range 2.4 kHz to 9.98 MHz with a resolution of 1 Hz. The synthesis is exact – there is no approximation or residual error. For example, if you select 168,231 kbps as the transmit data rate, and an E1 reference, there will be exactly 168,231 clock cycles generated for every 2,048,000 cycles of the E1 reference.

The internal ST clock is now used, as in the standard Internal Clock mode, to provide the timing reference for the externally-connected equipment. The data is then transmitted at the desired data rate to the distant end (or distant ends – this works for broadcast applications as well).

Now, at the distant end modem (timing mode: RX Satellite), the RX signal is received, demodulated, and the clock is recovered. A second synthesizer, very similar to the one used at the local modem, is now used to generate an E1 or T1 timing signal. Again, it should be emphasized that the synthesis is exact. The net result is that the E1 or T1 timing signal used at the local end is reproduced at the distant end, regardless of the link data rate.

The only thing that affects the overall accuracy and stability of the copy of the clock is the Doppler shift of the link itself. This will be very dependent on the particular satellite used, and the accuracy of the orbital station keeping (often referred to as orbital inclination). Typically the Doppler variations are in the order of parts in  $10^{-8}$ , but more importantly it should be recognized that, over a 24 hour period, the net error would be zero due to a fundamental characteristics of geostationary orbits.

The T1 or E1 signal, available on the rear panel of the modem on the G.703 connectors, is now used to provide a synchronizing source for equipment connected to the modem. The form of this is an 'all ones' signal, which provides the maximum transition density in the AMI signal.



**This scheme is sufficiently flexible to permit an E1 signal to be used at the local end, and a T1 signal to be reproduced at the distant end, or vice versa.**

## F.5.2 Clock Extension Mode 2

**Figure F-4** shows Clock Extension Mode 2. This is for situations where clock extension needs to be performed, but there is no local G.703 reference. In this case, the local modem now operates in an EXTERNAL clock mode and the accuracy of the TX Clock is determined solely by the accuracy of the equipment connected to the modem.

At the distant end, an E1 or T1 synchronizing signal is generated regardless of the link data rate, as in Mode 1.

## F.5.3 Clock Extension Mode 3

**Figure F-5** shows Clock Extension Mode 3. This is very similar to Mode 1 but now, instead of the EIA-530/V.35 serial interface being used, everything is based around the 10/100 Base T Ethernet interface.

At the distant end, an E1 or T1 synchronizing signal is generated regardless of the link data rate, as in Mode 1

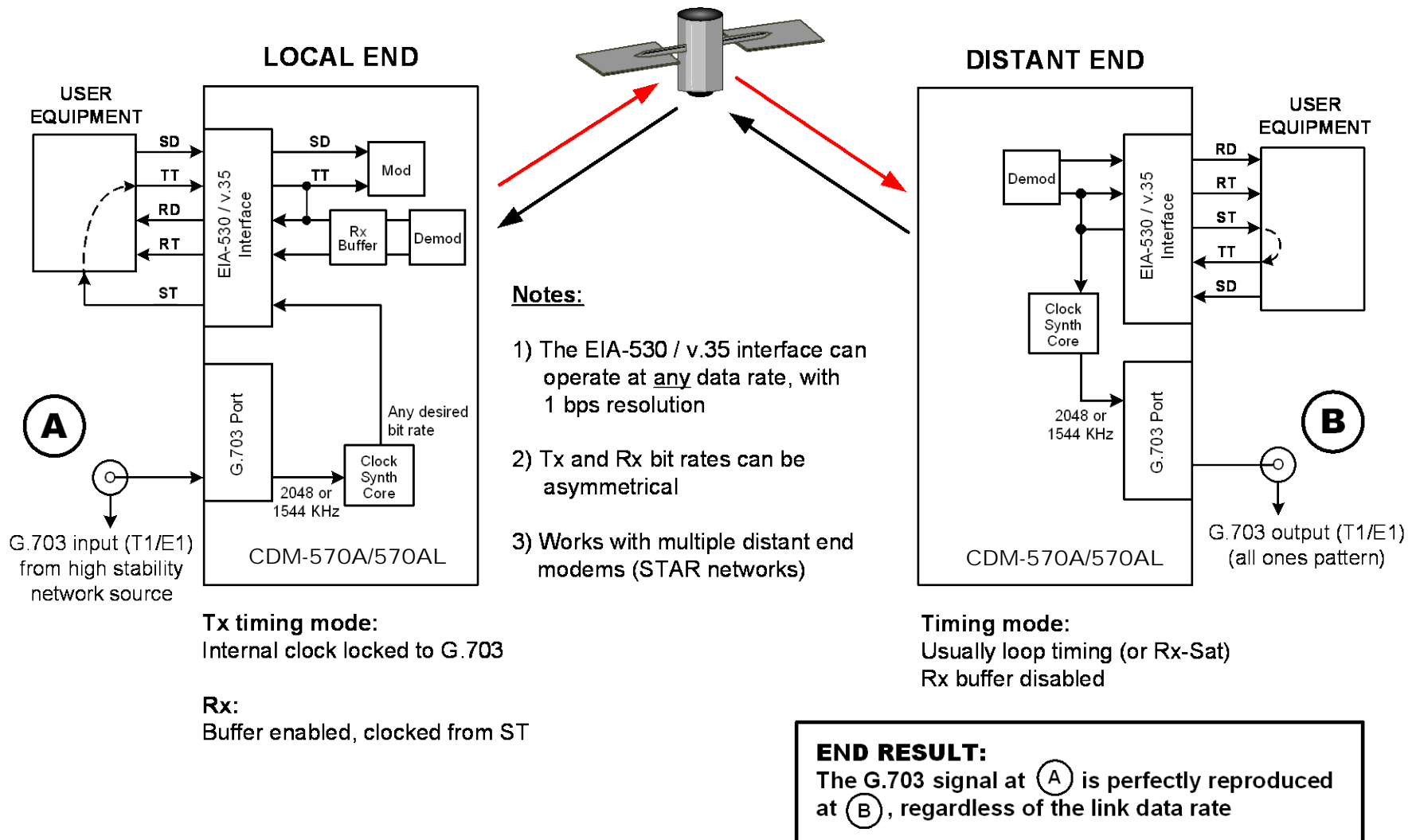

Figure F-3. G.703 Clock Extension Mode 1

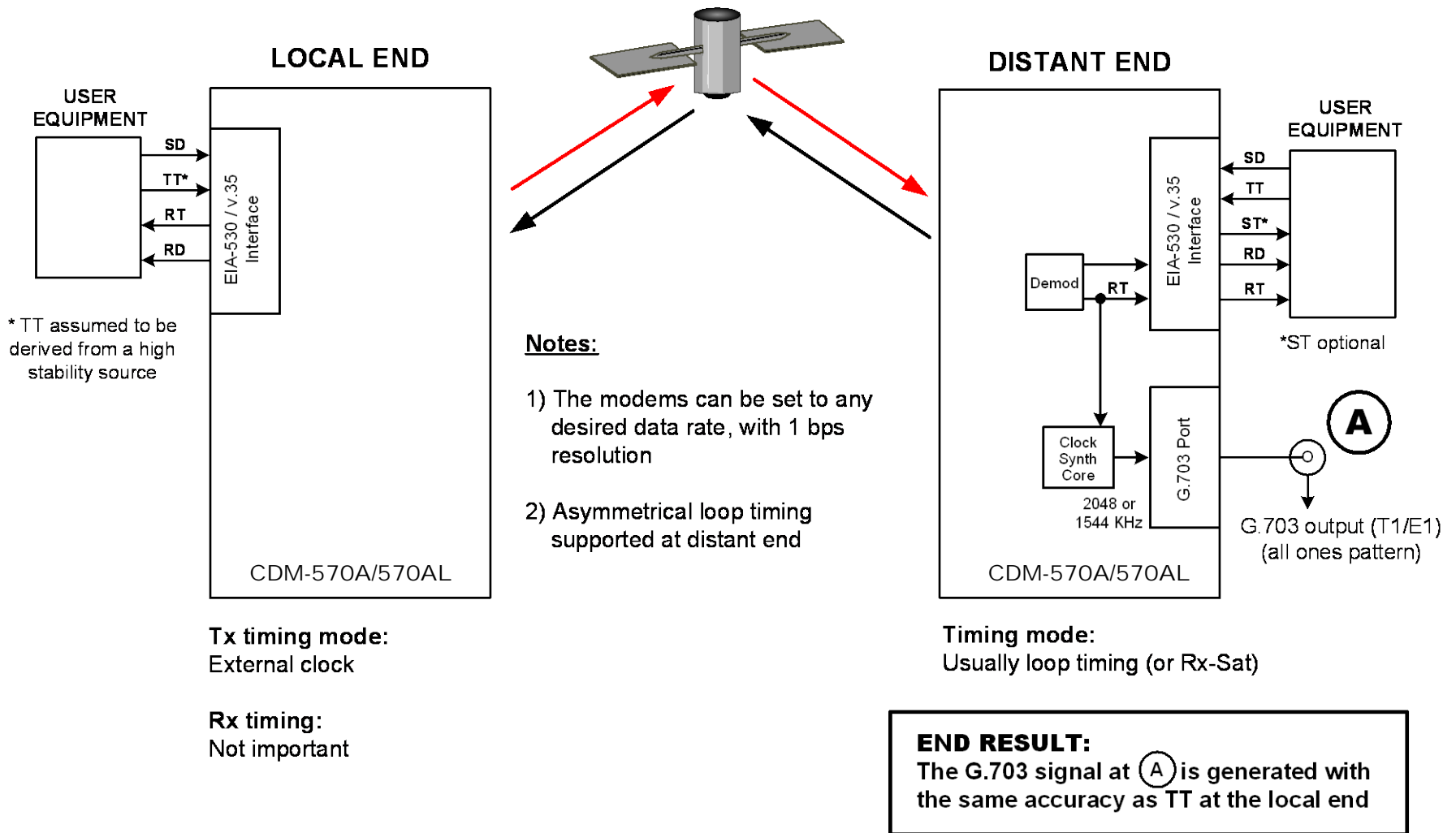

Figure F-4. G.703 Clock Extension Mode 2

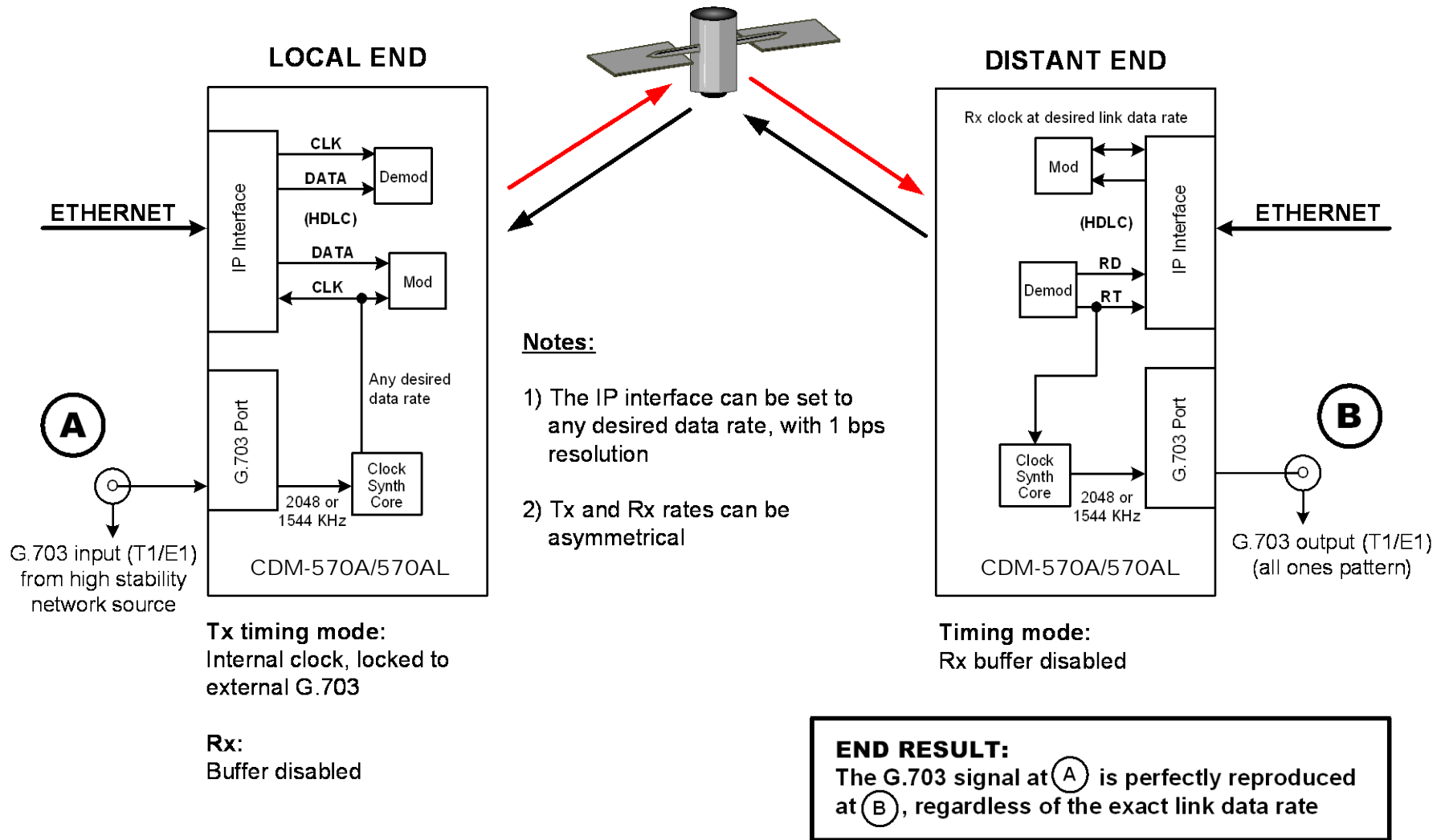

Figure F-5. G.703 Clock Extension Mode 3

BLANK PAGE

# Appendix G. DOUBLETALK CARRIER-IN-CARRIER OPTION



**WARNING! BEFORE ATTEMPTING TO COMMISSION A SATELLITE LINK USING CARRIER-IN-CARRIER, YOU **MUST** ENSURE THAT THE LINK IS ROBUST ENOUGH FOR NORMAL OPERATION. ONLY WHEN THIS HAS BEEN DONE – AND ALL SYSTEM ISSUES (E.G., ANTENNA-POINTING, CABLING, TERRESTRIAL INTERFERENCE, SATELLITE INTERFERENCE, ETC.) HAVE BEEN RESOLVED – SHOULD YOU ATTEMPT THE USE OF CARRIER-IN-CARRIER.**



**DoubleTalk Carrier-in-Carrier (CnC) and Carrier-in-Carrier Automatic Power Control (CnC-APC) are UNAVAILABLE and DISABLED when the CDM-570A/AL is configured to run in CDM-570 Compatible Mode.**

---

## G.1 Overview

Space segment costs are typically the most significant operating expense for any satellite-based service, having a direct impact on the viability and profitability of the service. For a satellite transponder that has finite resources in terms of bandwidth and power, the leasing costs are determined by bandwidth and power used. Therefore, a satellite circuit should be designed for optimal utilization to use a similar share of transponder bandwidth and power.

The traditional approach to balancing a satellite circuit – once the satellite and earth station parameters are fixed – involves trade-off between modulation and coding. A lower order modulation requires less transponder power while using more bandwidth; conversely, higher order modulation reduces required bandwidth, albeit at a significant increase in power.

Comtech EF Data has added a new dimension to satellite communication optimization: DoubleTalk Carrier-in-Carrier.

---

## G.2 What is DoubleTalk Carrier-in-Carrier?

The DoubleTalk Carrier-in-Carrier (CnC) option uses a patented signal processing algorithm developed by Raytheon Applied Signal Technology that allows both the forward and reverse carriers of a full duplex link to share the same segment of transponder bandwidth, using patented “Adaptive Cancellation.” Raytheon Applied Signal Technology uses the term DoubleTalk, and Comtech EF Data refers to it as DoubleTalk Carrier-in-Carrier (CnC)<sup>1</sup>.

---

<sup>1</sup> DoubleTalk® is licensed from Raytheon Applied Signal Technology.  
DoubleTalk® is a registered trademark of Raytheon Applied Signal Technology.

CnC was first introduced in Comtech EF Data's CDM-Qx Satellite Modem. CnC is now available on many Comtech EF Data products, including the CDM-625/A, CDM-760, CDM-750, DMD20, DMD2050E, and SLM-5650A. CnC is also available as a standalone product on the CLO-10 Link Optimizer.

This innovative technology provides a significant improvement in bandwidth and power utilization, beyond what is possible with FEC and modulation alone, allowing users to achieve unprecedented savings. When combined with advanced modulation and FEC, it allows for multi-dimensional optimization:

- Reduced operating expense (OPEX) – e.g., Occupied Bandwidth & Transponder Power;
- Reduced capital expenditure (CAPEX) – e.g., Block Up Converter/High-Power Amplifier (BUC/HPA) size and/or antenna size;
- Increased throughput without using additional transponder resources;
- Increased link availability (margin) without using additional transponder resources;
- A combination of any of the above to meet different objectives.

**Summary: When carriers share common bandwidth, up to 50% savings in transponder utilization is possible.**

---

### G.3 Application Requirements

The following conditions are necessary in order to operate DoubleTalk Carrier-in-Carrier:

- Link must be full duplex.
- A CDM-570A/AL must be used at the end of the link where the cancellation needs to take place.
- The transponder is operated as Loopback. That is, each end of the link must be able to see a copy of its own signal in the return (downlink) path from the satellite. The looped back signal is then subtracted which leaves the signal from the distant end of the link.  
**DoubleTalk Carrier-in-Carrier cannot be used in spot beam systems.**
- The transponder needs to be “bent-pipe” – meaning no on-board processing, demodulation, regeneration can be employed. Demodulation/remodulation does not preserve the linear combination of the forward and return signals and the resulting reconstituted waveform prevents recovery of the original constituent signals.

**Figure G-1** shows a simplified conceptual block diagram of CnC processing. The two ends of the link are denoted ‘A’ and ‘B’ and the uplink and downlink are shown.

---

Carrier-in-Carrier® is a registered trademark of Comtech EF Data.



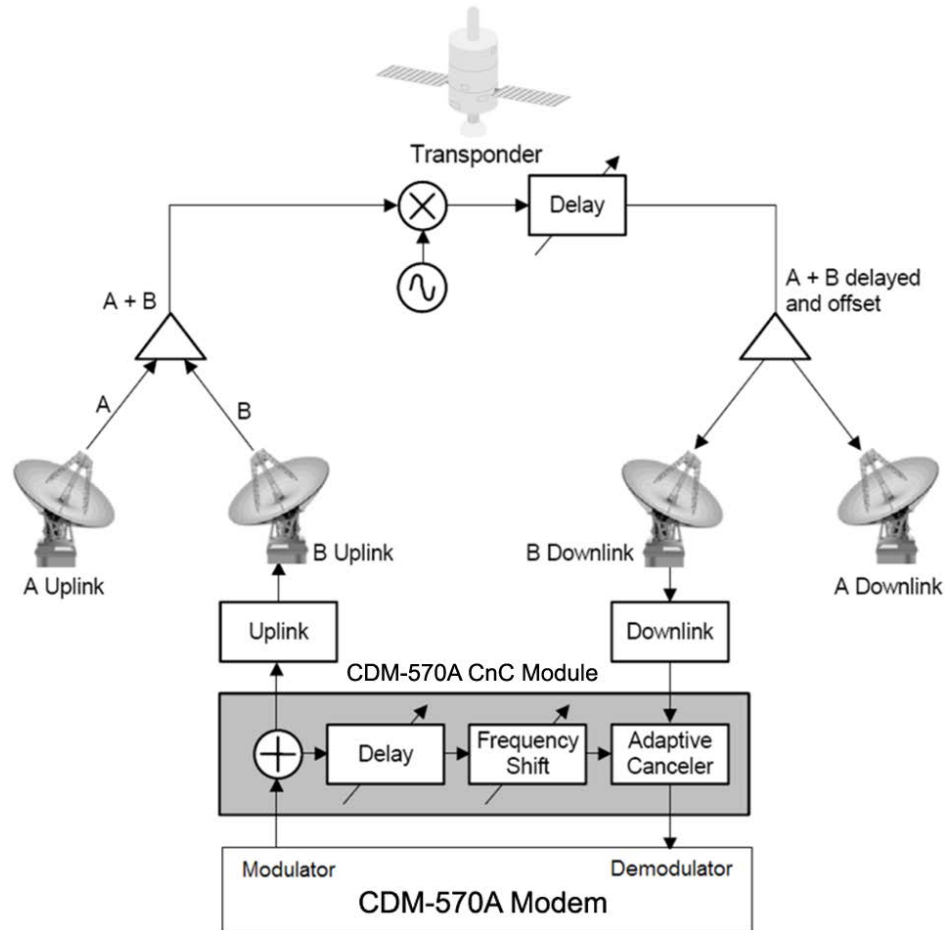

**Figure G-1. Conceptual Block Diagram**

This performance is achieved through advanced signal processing algorithms that provide superior cancellation while tracking and compensating for the following common link impairments:

1. **Time varying delay:** In addition to the static delays of the electronics and the round-trip delay associated with propagation to the satellite and back, there is a time-varying component due to movement of the satellite. The CnC module tracks and compensates for this variation.
2. **Frequency offset and drift:** Common sources are satellite Doppler shift, up and down converter frequency uncertainties, and other drift associated with the electronics in the CDM-570A/AL itself. The CnC module tracks and compensates for this frequency offset and drift.
3. **Atmospheric effects:** Fading and scintillation can affect amplitude, phase, and spectral composition of the signal and the degree to which it correlates with the original signal. The CnC module tracks and compensates for these atmospheric related impairments.

4. **Link Asymmetries:** Various asymmetries in the forward and return link can produce differences in the relative power of the two received signal components. These can be both deterministic (static) or random (and time varying). An example of the former would be the differences resulting from antenna size/gain variations between the two ends of the link. An example of the latter would be transient power differences due to different levels of atmospheric fading in the uplinks. CnC compensates for the asymmetries, up to a certain extent.

In a number of ways, CnC carriers behave similar to conventional carriers in satellite links. They are both exposed to adjacent carriers, cross-polarization and rain fade, and exhibit impairments when any of these become too great. In addition, CnC operates in an environment where:

- Carriers intentionally occupy the same spectral slot;
- Performance depends upon desired and co-located interfering carrier.

### G.3.1 Operational Recommendations

The rules for CnC operation are summarized as follows:

- Both earth stations share the same footprint so each sees both carriers
- CnC carriers are operated in pairs
- One outbound with multiple return carriers is not allowed
- Asymmetric data rates are allowed (no restrictions)
- The ratio of power spectral density is normally less than 11 dB
- CnC operates with modems – **not** modulators only or demodulators only

To minimize 'false' acquisition, also observe the following:

- Use of IESS-315 V.35 Scrambler is highly recommended
- Keep the search delay range as narrow as possible – once the modem has reported the search delay, narrow the search delay range to the nominal reported value  $\pm 5$  ms – for example, if the modem reported delay is 245 ms, narrow the search range to say 240-250 ms.
- Use external data source (e.g. Firebird) or internal BER tester when testing Carrier-in-Carrier performance.
- To prevent self-locking in case the desired carrier is lost, it is recommended that the two carriers have some configuration difference – for example, use different settings for Spectrum Inversion.

## G.4 System Functionality and Operational Considerations

**Figure G-2** illustrates a conventional, full duplex satellite link where two carriers are placed in non-overlapping channels. **Figure G-3** shows the same link using the CDM-570A/AL equipped with the DoubleTalk Carrier-in-Carrier option. Note that only 50% of the bandwidth is being used, as both carriers are now occupying the same bandwidth.

The transponder downlinks the composite signal containing both carriers on the same band to the CDM-570A/AL which then translates the signal to near baseband where it can be filtered (decimated) and then processed as a complex envelope signal. The CDM-570A/AL then suppresses the version of the near end carrier on the downlink side and then passes the desired carrier to the demodulator for normal processing.

To further illustrate, as shown in **Figure G-4**, without DoubleTalk Carrier-in-Carrier, the two carriers in a typical full duplex satellite link are adjacent to each other. With DoubleTalk Carrier-in-Carrier, only the composite signal is visible when observed on a spectrum analyzer. Carrier 1 and Carrier 2, shown here for reference only, are overlapping, thus sharing the same spectrum.

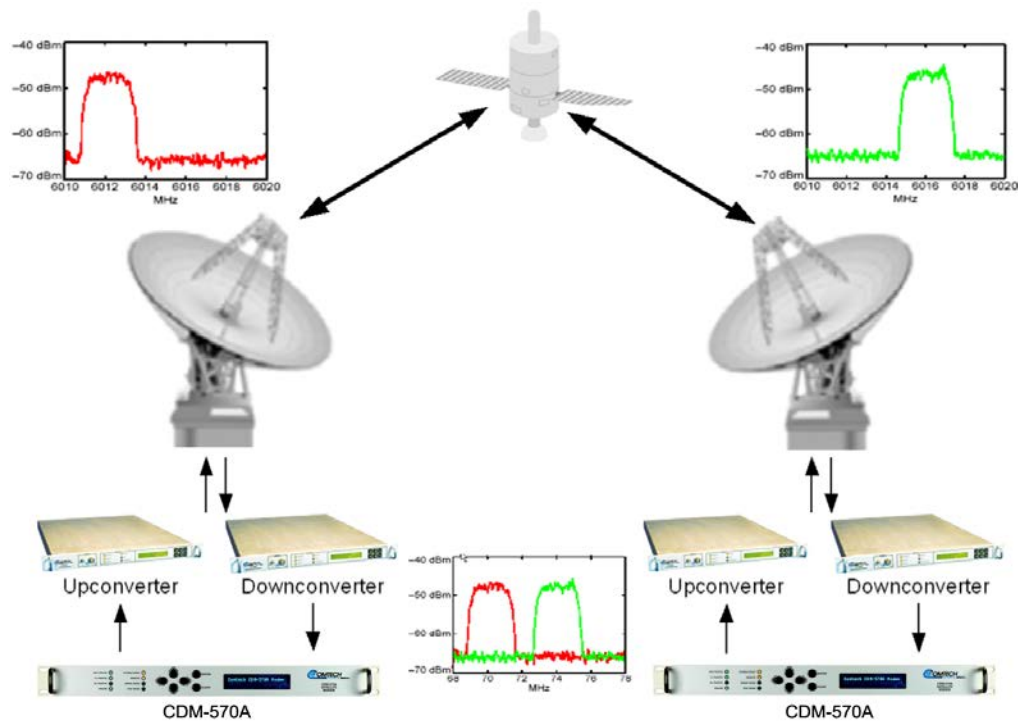

**Figure G-2. Conventional FDMA Link**

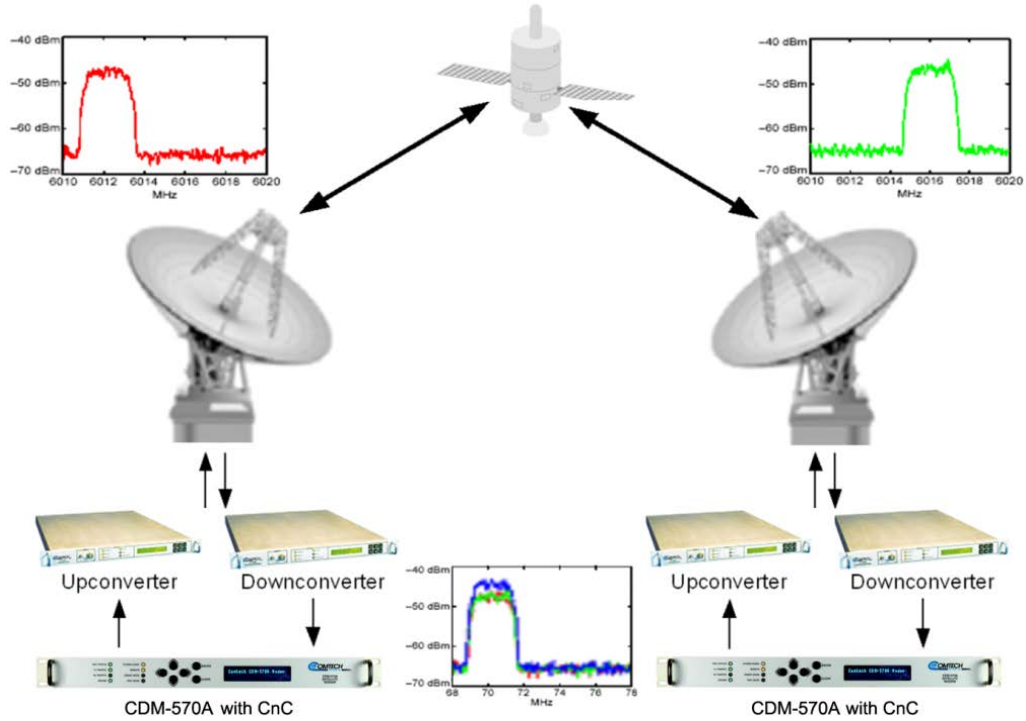

**Figure G-3. Same Link Using CDM-570A with DoubleTalk Carrier-in-Carrier**

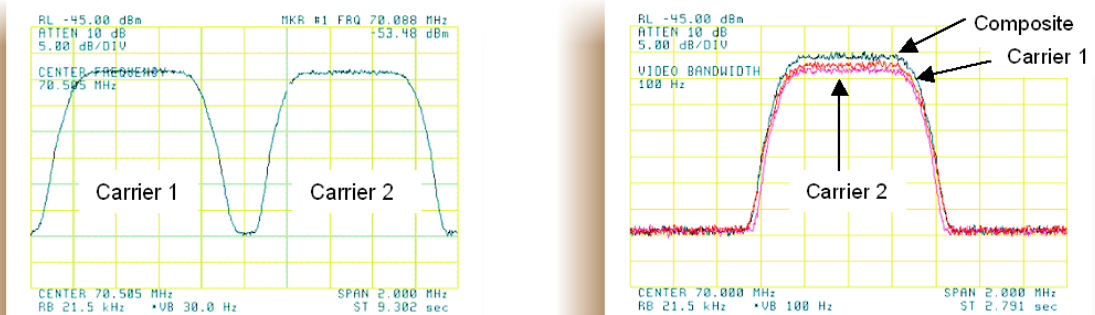

**Traditional Full Duplex Link**

**Duplex Link with DoubleTalk Carrier-in-Carrier**

**Figure G-4. Duplex Link Optimization**

The CDM-570A/AL CnC module operates on the near-zero signal before the demodulator, and is waveform agnostic. This means that no prior knowledge of the underlying modulation, FEC, or any other waveform specific parameter is required in order to perform the signal suppression operation. The only caveat to this is that the waveform must be sufficiently random.

Because acquiring the delay and frequency offset of the interfering carrier is fundamentally a correlation operation, anything deterministic in the interfering carrier (within the correlation window of the algorithm) will potentially produce false correlation peaks and result in incorrect delays and/or frequency. Normally, this is not a problem, since energy dispersal techniques are utilized in the vast majority of commercial and military modems. However, it is something that must be kept in mind when troubleshooting a system that utilizes the DoubleTalk Carrier-in-Carrier technique for signal suppression.

One possible way to mitigate false peaks is to narrow the correlation window. For example, if the delay is known to be around 240ms, set the minimum search delay to 230ms and the maximum search delay to 250ms.

As all advances in modem technologies – including advanced modulation and FEC techniques – approach their theoretical limits of power and bandwidth efficiencies, DoubleTalk Carrier-in-Carrier allows satellite users to achieve spectral efficiencies (bps/Hz) that cannot be achieved with modulation and FEC alone. **Table G-1** illustrates how DoubleTalk Carrier-in-Carrier, when used with 16-QAM, approaches the bandwidth efficiency of 256-QAM (8bps/Hz).

**Table G-1. Spectral Efficiency using DoubleTalk Carrier-in-Carrier**

Modulation and Code Rate	Spectral Efficiency (bps/Hz)	
	TraditionalSCPC	Carrier-in-Carrier
BPSK 1/2	0.50	1.00
QPSK 1/2	1.00	2.00
QPSK 3/4	1.50	3.00
QPSK 7/8	1.75	3.50
8-QAM 3/4	2.25	4.50
8-QAM 7/8	2.63	5.25
16-QAM 3/4	3.00	6.00
16-QAM 7/8	3.50	7.00



As shown here, DoubleTalk Carrier-in-Carrier allows equivalent spectral efficiency using a lower order modulation and/or FEC Code Rate; CAPEX is therefore reduced by allowing the use of a smaller BUC/HPA and/or antenna. And, as DoubleTalk Carrier-in-Carrier can be used to save transponder bandwidth and/or transponder power, it can be successfully deployed in bandwidth-limited as well as power-limited scenarios.

### G.4.1 DoubleTalk Carrier-in-Carrier Cancellation Process

The state-of-the-art signal processing technology employed via DoubleTalk Carrier-in-Carrier continually estimates and tracks all parametric differences between the local uplink signal and its image within the downlink. Through advanced adaptive filtering and phase locked loop implementations, it dynamically compensates for these differences by appropriately adjusting the delay, frequency, phase and amplitude of the sampled uplink signal, resulting in excellent cancellation performance.

When a full duplex satellite connection is established between two sites, separate satellite channels are allocated for each direction. If both directions transmitted on the same channel, each side would normally find it impossible to extract the desired signal from the aggregate due to interference originating from its local modulator. However since this interference is produced locally, it is possible to estimate and remove its influence prior to demodulation of the data transmitted from the remote location.

For the DoubleTalk Carrier-in-Carrier cancellation, it is necessary to provide each demodulator with a copy of its local modulator's output.

**Refer to Figure G-5:** Modem 1 and Modem 2 transmit signals  $S_1$  and  $S_2$  respectively. The satellite receives, translates, and retransmits the composite signal. The downlink signals  $S_1^*$  and  $S_2^*$ , received at Modem 1 and Modem 2 differ from the transmit signals primarily in terms of phase, frequency, and delay offsets.

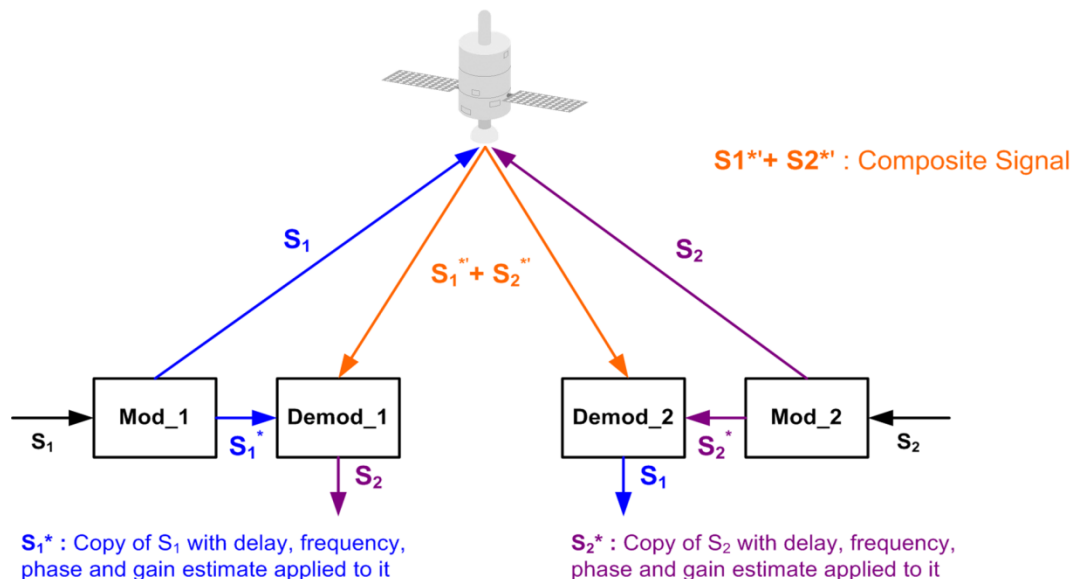

**Figure G-5. DoubleTalk Carrier-in-Carrier Signals**

**Refer to Figure G-6:** For round trip delay estimation, a search algorithm is utilized that correlates the received satellite signal to a stored copy of the local modulator's transmitted signal. The interference cancellation algorithm uses the composite signal and the local copy of  $S_1$  to estimate the necessary parameters of scaling (complex gain/phase), delay offset and frequency offset. The algorithm continuously tracks changes in these parameters as they are generally time-varying in a satellite link.

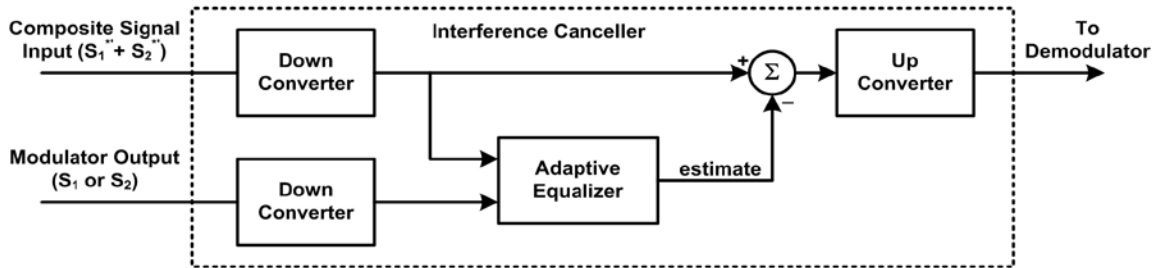

**Figure G-6. Carrier-in-Carrier Signal Processing Block Diagram**

The resulting estimate of the unwanted interfering signal is then subtracted from the composite signal. In practical applications, the estimate of the unwanted signal can be extremely accurate. Unwanted interfering signal suppression of 30 dB or more has been achieved in commercial products with minimal degradation of the demodulator performance.

## G.4.2 Margin Requirements

Typical interfering signal cancellation is 28 to 35 dB (depending on the product). The residual interfering signal appears as noise causing a slight degradation of the  $E_b/N_0$ . To compensate for the residual noise, a small amount of additional link margin is required to maintain the BER. Margin requirements depend on the product, modulation and power ratios:

For the CDM-570A/AL, the additional margin requirements are as follows:

Modulation	Nominal Margin*
BPSK	0.3 dB
QPSK/OQPSK	0.3 dB
8-PSK	0.5 dB
8-QAM	0.4 dB
16-QAM	0.6 dB
8-ARY	0.6 dB
16-ARY	0.8 dB
32-ARY	1.0 dB

\* Equal power and equal symbol rate for the interfering carrier and the desired carrier, i.e., 0 dB PSD ratio. Measured at IF with AWGN, +10 dBc Adjacent Carriers, 1.3 spacing.

### G.4.3 Carrier-in-Carrier Latency

Carrier-in-Carrier has no measurable impact on circuit latency.

### G.4.4 Carrier-in-Carrier and Adaptive Coding and Modulation

Carrier-in-Carrier will be fully compatible with the VersaFEC Adaptive Coding and Modulation (ACM) mode of operation that will be available in future releases of the CDM-570A/AL.

Carrier-in-Carrier combined with VersaFEC ACM can provide a 100-200% increase in average throughput compared to a traditional side-by-side link without ACM.

### G.4.5 Carrier-in-Carrier Link Design

Carrier-in-Carrier link design involves finding the FEC and modulation combination that provides optimal bandwidth utilization. Just like conventional link design, it is an iterative process that involves trying different FEC and modulation combinations with Carrier-in-Carrier until an optimal combination is found.

For optimal Carrier-in-Carrier performance, it is recommended that the two carriers have similar symbol rate and power. This can be achieved by selecting appropriate ModCods as shown in following sections.

---

#### G.4.5.1 Symmetric Data Rate Link

**NOTE:** CnC operation with symmetrical links requires the Symbol Rate to be offset by 0.1% or higher on one of the links when the IP Data Interface is selected.

Consider the following example:

Satellite & Transponder	IS-901 @ 342° W, 22/22 (EH/EH)
Earth Station 1	Africa – 4.5 m
Earth Station 2	Africa – 3.0 m
Data Rate	1.0 Mbps / 1.0 Mbps

The traditional link was based on QPSK TPC 7/8, and required 1.6 MHz of leased bandwidth (BW).



The LST (Intelsat Lease Transmission Plan Program) summary for the traditional link is as follows:

Link Analysis Description		
Multicarrier Transponder Lease Number of Links: 2	Link 1	Link 2
Modulation	QPSK	QPSK
Information Rate (kbit/s)	1000.0	1000.0
FEC Code Rate	.875	.875
R-S Code Rate	N/A	N/A
Clear Sky Eb/No Available	6.3	6.0
Number of Assigned Carriers	1	1
Transmit ES Code	HUB	REMOTE
Transmit ES Size (m)	4.5	3.0
Receive ES Code	REMOTE	HUB
Receive ES Size (m)	3.0	4.5
Receive ES G/T (dB/K)	21.5	25.3

Total Leased Resource Usage			
LST Calculated (MultiCarrier Transponder Lease)		Total BW Allocated	1.6000 MHz
		TotalBW PEB*	1.5937 MHz
Total EIRP Utilized	15.0 dBw	Total BW Utilized	1.6000 MHz
Total EIRP Available	15.0 dBw	Total BW Available	1.6000 MHz
Margin (available-utilized)	.0 dBw	Margin (available-utilized)	0.0000 MHz
*PEB = Power Equivalent Bandwidth			
<b>Allocated BW = 1.6 MHz</b>			
<b>PEB = 1.5937 MHz</b>			
<b>Leased BW = 1.6 MHz</b>			

Carrier-in-Carrier link design involved trying different Modulation & FEC Code Rates to find the optimal combination (the CDM-570A/AL also offers 5% to 35% transmit filter rolloffs that can be used in addition to Modulation and FEC for link optimization):

- QPSK, VersaFEC 0.706 with Carrier-in-Carrier
- QPSK, VersaFEC 0.631 with Carrier-in-Carrier
- QPSK, VersaFEC 0.533 with Carrier-in-Carrier

Link parameters and LST summary, for QPSK, VersaFEC 0.533 with Carrier-in-Carrier, is as follows:

Digital Carrier Definition

Select From Available Products & Modems...

Carrier Type: DIGITAL

Performance (BER):

FEC Code Rate: .5330

R-S Code Rate: n= N/A, k= N/A

Overhead: .0 %

Modulation: QPSK

Eb/No Threshold: 3.0 dB

C/N Threshold: 3.3 dB

U/L Carrier Center Freq.: 6014.00000 MHz

Car/Link: 1, Act. Fact.: 100 %

Information Rate: 1000.0 kbits/s

Alloc. BW: .10, 1.0319 MHz

Noise BW: .9381 MHz

Spreading Factor: 1

Min Uplink Rain Margin: dB

Min Dnlink Degrad. Margin: dB

Total Availability: 99.960 % yr

Transmit ES Code: REMOTE

Receive ES Code: HUB

Buttons: Return, Accept, Copy, Cancel, Edit CCT Link...

Link: 1, 2, 2

- User Specified  
- LST Calculated

This link is part of a CCT Network. Only certain parameters may be modified in this window and may result in non-optimal performance. To modify this link in the CCT window, select 'Edit CCT Link...' button.

Includes IF-RF Margin and CnC Margin

Link Analysis Description		
Multicarrier Transponder Lease Number of Links: 2	Link 1	Link 2
Modulation	QPSK	QPSK
Information Rate (kbit/s)	1000.0	1000.0
FEC Code Rate	.5330	.5330
R-S Code Rate	N/A	N/A
Clear Sky Eb/No Available (dB)	4.3	4.1
Number of Assigned Carriers	1	1
Transmit ES Code	HUB	REMOTE
Transmit ES Size (m)	4.5	3.0
Receive ES Code	REMOTE	HUB
Receive ES Size (m)	3.0	4.5
Receive ES G/T (dB/K)	21.5	25.3

Total Leased Resource Usage			
LST Calculated (MultiCarrier Transponder Lease)		Total BW Allocated	1.0319 MHz
		TotalBW PEB*	.9755 MHz
Total EIRP Utilized	12.8 dBw	Total BW Utilized	1.0319 MHz
Total EIRP Available	13.3 dBw	Total BW Available	1.1000 MHz
Margin (available-utilized)	.5 dBw	Margin (available-utilized)	0.681 MHz
*PEB = Power Equivalent Bandwidth			
<b>CnC Allocated BW = 1.0319 MHz</b>			
<b>CnC PEB = 0.9755 MHz</b>			
<b>CnC Leased BW = 1.03196 MHz</b>			

The link budget summary for the different ModCod combinations is as follows:

S.No.	Modulation & FEC (CnC Carrier)	Allocated BW (MHz)	PEB (MHz)	Leased BW (MHz)	CnC Leased BW Savings	PSD Ratio (dB)
1	QPSK, VersaFEC 0.533, 10% ROF	1.0319	0.9755	1.0319	36%	2.2
2	QPSK, VersaFEC 0.631, 15% ROF	0.9113	1.1069	1.1069	31%	2.2
3	QPSK, VersaFEC 0.706, 25% ROF	0.8859	1.3223	1.3223	17%	2.2

Based on this analysis, QPSK, VersaFEC 0.533 with Carrier-in-Carrier provides savings of 36%. In addition to this 36% reduction in Leased Bandwidth, using Carrier-in-Carrier also reduced the BUC requirement from 10W to 5W:

BUC Size	Traditional Link (QPSK, TPC 7/8)	CnC Link (QPSK, VersaFEC 0.533)	BUC Size Reduction
BUC @ 4.5 m	10 W	5 W	50%
BUC @ 3.0 m	10 W	5 W	50%

### G.4.5.2 Asymmetric Data Rate Link

As occupied (or allocated) bandwidth of a Carrier-in-Carrier circuit is dictated by the larger of the two carriers, it is strongly recommended that the smaller carrier be spread as much as possible using a lower order modulation and/or FEC, while meeting the PSD ratio spec. Spreading the smaller carrier using a lower order modulation has multiple benefits:

- Lower order modulation is always more robust;
- Lower order modulation uses less transponder power – this reduces total transponder, and increases available link margin;
- Lower order modulation uses less transmit power on the ground – this can significantly reduce the BUC/SSPA size by not only reducing the transmit EIRP, but also reducing the BUC/SSPA backoff.

Consider the following example:

Satellite & Transponder	IS-901 @ 342° W, 22/22 (EH/EH)
Earth Station 1	Africa – 4.5 m
Earth Station 2	Africa – 3.0 m
Data Rate	3 Mbps / 1 Mbps

While the traditional link was based on QPSK, TPC 3/4 for the Hub to Remote and QPSK TPC 7/8 for Remote to Hub and required 4.0 MHz of leased bandwidth, the Carrier-in-Carrier link was based on QPSK, VersaFEC 0.631 and QPSK, VersaFEC 0.533 and required 2.9 MHz of leased bandwidth.

The savings summary is as follows:

Item	Original Link			With Carrier-in-Carrier and VersaFEC			Savings / Reduction
	Hub to Remote	Remote to Hub	Total	Hub to Remote	Remote to Hub	Total	
Data Rate (kbps)	3000	1000		3000	1000		
Modulation	QPSK	QPSK		QPSK	QPSK		
FEC	TPC 3/4	TPC 7/8		VersaFEC 0.631	VersaFEC 0.533		
Occupied BW (MHZ)	2.8	1.2	4.0	2.9	1.4	2.9	
Power Eq. BW (MHz)	3.2	0.7	3.9	2.3	0.5	2.8	
Leased BW (MHz)			4.0			2.9	28.7%
Hub BUC (W)	30			20			33%
Remote BUC (W)	20			10			33%

### G.4.5.3 Power Limited Links

Carrier-in-Carrier can provide substantial savings even when the original link is power limited. Spreading the carrier by using a lower modulation and/or FEC along with latest FEC such as VersaFEC can substantially reduce the total power, which can then be traded with bandwidth using Carrier-in-Carrier. The concept is illustrated with the following examples:

The conventional link is using 8-PSK, TPC 3/4:

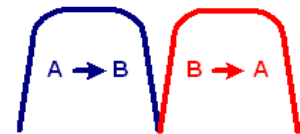

Switching to VersaFEC and using a lower order modulation – e.g., QPSK, VersaFEC 0.803 increases the total occupied bandwidth, while reducing the total power equivalent bandwidth:

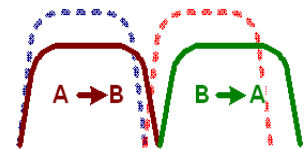

Now using DoubleTalk Carrier-in-Carrier, the second QPSK, VersaFEC 0.803 carrier can be moved over the first carrier – thereby significantly reducing the total occupied bandwidth and total power equivalent bandwidth when compared to the original side-by-side 8PSK, TPC 3/4 carriers:

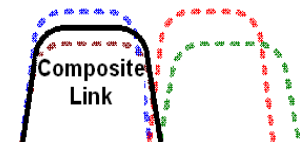

To continue, consider this example:

Satellite & Transponder	IS-901 @ 342° W, 22/22 (EH/EH)
Earth Station 1	Africa – 9.2 m
Earth Station 2	Africa – 4.5 m
Data Rate	2.048 Mbps / 2.048 Mbps

Whereas the original link used 8-PSK TPC 3/4, the Carrier-in-Carrier link used QPSK VersaFEC 0.803.

The savings summary is as follows:

Item	Original Link			With Carrier-in-Carrier and VersaFEC			Savings
	Hub to Remote	Remote to Hub	Total	Hub to Remote	Remote to Hub	Total	
Data Rate (kbps)	2048	2048		2048	2048		
Modulation	8-PSK	8-PSK		QPSK	QPSK		
FEC	TPC 3/4	TPC 3/4		VersaFEC 0.803	VersaFEC 0.803		
Occupied BW (MHZ)	1.3	1.3	2.6	1.8	1.8	1.8	
Power Eq. BW (MHz)	2.2	1.0	3.2	1.1	0.5	1.6	
Leased BW (MHz)			3.2			1.8	44%
Hub BUC (W)	5			2			60%
Remote BUC (W)	20			5			75%

Using Carrier-in-Carrier and VersaFEC reduced the leased bandwidth by almost 44% and the BUC size by 60% at the Hub and 75% at the Remote.

### G.4.5.4 Commission and Deploy Carrier-in-Carrier

Prior to commissioning a Carrier-in-Carrier link, it is critical that the link is fully tested in non Carrier-in-Carrier mode and all system issues including external interference, antenna pointing, cabling, SSPA backoff are resolved. Only after the link is robust, should you attempt turning on Carrier-in-Carrier. The following steps are recommended for Carrier-in-Carrier commissioning and deployment:

Step	Task
1	<p>Turn ON the carrier at Site A. Carrier from Site B is OFF. CnC function is OFF at both sites.</p> <ul style="list-style-type: none"> <li>➤ Using a spectrum analyzer, measure Co+No/No at the input to the modem at Site A.</li> <li>➤ Using a spectrum analyzer, measure Co+No/No at the input to the modem at Site B.</li> <li>➤ Measure/record Eb/No at Site B. Make sure there is sufficient margin to account for CnC.</li> <li>➤ Measure/record Receive Signal Level (RSL) at Site B.</li> </ul>
2	<p>Turn OFF the carrier at Site A. Turn ON the carrier at Site B. CnC function is OFF at both sites.</p> <ul style="list-style-type: none"> <li>➤ Using a spectrum analyzer, measure Co+No/No at the input to the modem at Site A.</li> <li>➤ Using a spectrum analyzer, measure Co+No/No at the input to the modem at Site B.</li> <li>➤ Measure/record Eb/No at Site A. Make sure there is sufficient margin to account for CnC.</li> <li>➤ Measure/record RSL at Site B.</li> </ul>
3	<p>Using Co+No/No readings calculate PSD ratio at Site A and Site B. If it is not within specification, make necessary adjustments to bring it within specification and repeat measurements in Step (1) and (2).</p> <ul style="list-style-type: none"> <li>➤ Also verify that the RSL is within spec.</li> </ul>
4	<p>Now without changing the transmit power levels, turn ON both the carriers (on the same frequency) and turn CnC ON.</p> <ul style="list-style-type: none"> <li>➤ Measure/record Eb/No at Site A and B.</li> <li>➤ Measure/record RSL at Site A and B.</li> <li>➤ Now compare Eb/No in presence of 2 over lapping carriers with CnC with Eb/No when only 1 carrier was ON. Eb/No variation should be within spec for that modulation, FEC and PSD ratio.</li> </ul>
5	<p>The test can be repeated for different PSD ratio and Eb/No.</p>

## G.4.6 Validate Carrier-in-Carrier Performance

Carrier-in-Carrier performance can be easily validated by verifying that  $E_b/N_0$  degradation due to Carrier-in-Carrier is within published specification for the observed Power Spectral Density Ratio.

Comtech EF Data recommends the following steps for validating Carrier-in-Carrier performance:

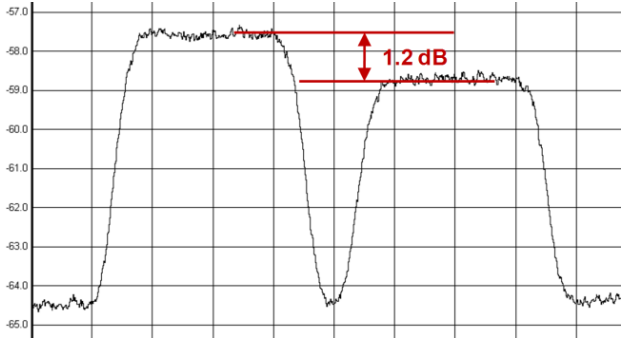
Step	Task
1	<p>Setup a conventional side-by-side link of the desired <math>E_b/N_0</math>:</p> <ul style="list-style-type: none"> <li>➤ Carrier-in-Carrier should be OFF.</li> <li>➤ Record the <math>E_b/N_0</math> as displayed by the Modems.</li> <li>➤ Observe the 2 carriers on a spectrum analyzer and record the PSD ratio.</li> </ul> <p><b>Example Link:</b></p> <ul style="list-style-type: none"> <li>• Full duplex 512 kbps, QPSK, VersaFEC 0.631 circuit between 4.6 m and 2.4 m antennas</li> <li>• Recorded <math>E_b/N_0 = 2.7</math> dB (at both modems)</li> <li>• PSD Ratio = 1.2 dB (measured at larger Antenna)</li> </ul> 
2	<p>Now relocate one of the carriers on top of the other carrier:</p> <ul style="list-style-type: none"> <li>➤ Enable Carrier-in-Carrier.</li> <li>➤ Record the <math>E_b/N_0</math> as displayed by the Modems.</li> </ul>

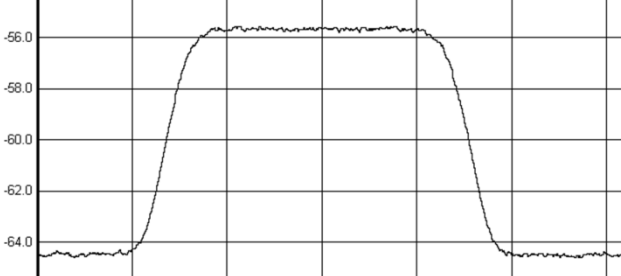

Step	Task
3	<p>Calculate change in Eb/No and verify against specification.</p> <p><b>Example Link:</b></p> <ul style="list-style-type: none"> <li>Recorded Eb/No = 2.5 dB</li> <li>Change in Eb/No = 0.2 dB</li> <li>Eb/No Degradation (Spec.) at 1.2 dB PSD = 0.3 dB</li> <li><b>Modem performance is within spec</b></li> </ul> 

## G.5 Operational References

### G.5.1 Calculate Carrier-in-Carrier Link Budget

You must follow these steps to calculate the link budget for a Carrier-in-Carrier Link:  $E_b/N_0$ .

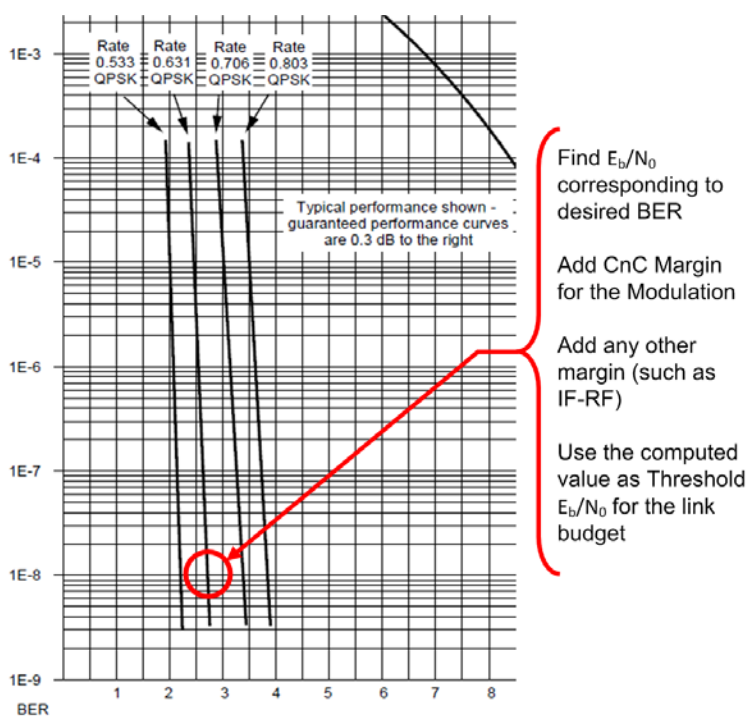
Step	Task
1	<p>Calculate the link budget for both carriers in the duplex link, with required CnC margin:</p>  <p>Typical performance shown - guaranteed performance curves are 0.3 dB to the right</p> <p>Find <math>E_b/N_0</math> corresponding to desired BER</p> <p>Add CnC Margin for the Modulation</p> <p>Add any other margin (such as IF-RF)</p> <p>Use the computed value as Threshold <math>E_b/N_0</math> for the link budget</p>
2	Verify that the PDS ration is within spec for the CDM-570A/AL.
3	<p>Calculate the Allocated Bandwidth (BW) and Power Equivalent Bandwidth (PEB) for the duplex link:</p> <ul style="list-style-type: none"> <li>• <math>BW_{\text{Duplex Link}} = \text{Greater of } (BW_{\text{Carrier 1}}, BW_{\text{Carrier 2}})</math></li> <li>• <math>PEB_{\text{Duplex Link}} = PEB_{\text{Carrier 1}} + PEB_{\text{Carrier 2}}</math></li> <li>• <math>\text{Leased } BW_{\text{Duplex Link}} = \text{Greater of } (BW_{\text{Duplex Link}}, PEB_{\text{Duplex Link}})</math></li> </ul>
4	For an optimal link, the Leased Bandwidth and the Power Equivalent Bandwidth should be equal / nearly equal.
5	Repeat the link budget process by selecting different Modulation and FEC, until the BW and PEB is nearly balanced.

### G.5.2 Estimate PSD Ratio

You can estimate PSD from a link budget using Downlink EIRP and Symbol Rate:

$$\text{PSD} = \text{Downlink EIRP} - 10 * \text{Log} (\text{Symbol Rate})$$

PSD Ratio Example:

Carrier	Downlink EIRP	Symbol Rate	Power Spectral Density
A to B	27 dBW	500 ksps	-29.99 dBW/Hz
B to A	24 dBW	375 ksps	-31.74 dBW/Hz

$$\text{PSD Ratio (@ A)} = -29.99 - (-31.74) = 1.75 \text{ dB}$$

$$\text{PSD Ratio (@ B)} = -31.74 - (-29.99) = -1.75 \text{ dB}$$

#### G.5.2.1 Estimate PSD Ratio from LST

Carrier Information	Link 1	Link 2	
Carrier Type	IPL	IPL	
Performance			BER
Modulation	8-Phase	8-Phase	
Eb/No Threshold	5.6	5.6	dB
C/N Threshold	8.6	8.6	dB
Center Frequency	6014.0	6014.0	MHz
Information Rate (IR)	4096.0	4096.0	kbit/s
Overhead (OH)	.0	.0	kbit/s
Data Rate (IR + OH)	4096.0	4096.0	kbit/s
FEC Code Rate	.6667	.6667	
R-S Code Rate	N/A	N/A	
Transmission Rate	6143.7	6143.7	kbit/s
Bandwidths and Margins			
Filter Rolloff Factor	.40	.40	
Allocated Bandwidth	2.8671	2.8671	MHz
Noise Bandwidth	2.0479	2.0479	MHz
Number of Assigned Carriers Per Link	1	1	

**PSD Link 2**  
 $15.8 - 10 * \text{Log} (2.0479 * 1000000) = -47.3 \text{ dBW/Hz}$

**PSD Ratio**  
 $\pm 1.0 \text{ dB}$

**PSD Link 1**  
 $16.8 - 10 * \text{Log} (2.0479 * 1000000) = -46.3 \text{ dBW/Hz}$

Per Carrier UL & DL eirp (Clr-Sky)	Link 1	Link 2	
Transmit ES elevation angle	70.4	54.5	deg.
Uplink EIRP per carrier	58.7	57.0	dBW
Pathloss at uplink frequency	199.3	199.5	dB
Gain of 1 m2 antenna	37.1	37.1	dB
Per carrier FD @SC	-103.5	-105.4	dBW/m2
SC pattern advantage @ES	1.8	2.8	dB
Per carrier BE FD arriving @ SC	-101.7	-102.7	dBW/m2
Transponder BE SFD	-79.0	-79.0	dBW/m2
Per carrier input back-off	-22.7	-23.7	dB
Per carrier output back-off	-20.2	-21.2	dB
Transponder BE saturation EIRP	37.0	37.0	dBW
Downlink BE EIRP	16.8	15.8	dBW

### G.5.2.2 Estimate PSD Ratio from Satmaster

#### Carrier A to B

Space Segment Utilization	Value	Units
Overall availability	99.9000	%
Information rate	5.0000	Mbps
Information rate (inc overhead)	5.0000	Mbps
Transmit rate	7.0323	Mbps
Symbol rate	2.3441	Mbaud
Noise Bandwidth	63.70	dB.Hz
Occupied bandwidth	2.4613	MHz
Minimum allocated bandwidth required	2.4613	MHz
Allocated transponder bandwidth	2.5000	MHz
Link efficiency	2.000	bps/Hz
Percentage transponder bandwidth used	4.63	%
Used transponder power	24.34	dBW
Percentage transponder power used	2.86	%
Max carriers / transponder	21.60	%
Limited by:	Bandwidth	MHz
Power equivalent bandwidth usage	1.5457	MHz

**PSD (Carrier A->B)**  
 $= 24.34 - 10 * \log(2.3441 \times 10^{-6})$   
 $= -39.36 \text{ dBW/Hz}$

**PSD (Carrier B->A)**  
 $= 21.88 - 10 * \log(2.3441 \times 10^{-6})$   
 $= -41.82 \text{ dBW/Hz}$

**PSD Ratio**  
 $\pm 2.46 \text{ dB}$

#### Carrier B to A

Space Segment Utilization	Value	Units
Overall availability	99.9000	%
Information rate	5.0000	Mbps
Information rate (inc overhead)	5.0000	Mbps
Transmit rate	7.0323	Mbps
Symbol rate	2.3441	Mbaud
Noise Bandwidth	63.70	dB.Hz
Occupied bandwidth	2.4613	MHz
Minimum allocated bandwidth required	2.4613	MHz
Allocated transponder bandwidth	2.5000	MHz
Link efficiency	2.000	bps/Hz
Percentage transponder bandwidth used	4.63	%
Used transponder power	21.88	dBW
Percentage transponder power used	1.74	%
Max carriers / transponder	21.60	%
Limited by:	Bandwidth	MHz
Power equivalent bandwidth usage	0.9375	MHz

**CnC Ratio**  
 $\pm 2.46 \text{ dB}$

### G.5.2.3 Use a Spectrum Analyzer to Estimate PSD Ratio

You can also estimate PSD Ratio or CnC Ratio by using a Spectrum Analyzer capable of integrating the signal power in a given bandwidth.

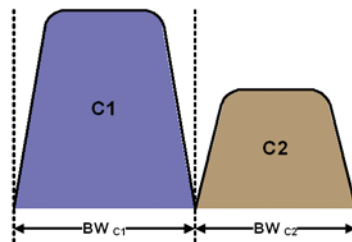

- CnC Ratio (in dB) = Power<sub>C1</sub> (in dBm) – Power<sub>C2</sub> (in dBm)
- PSD Ratio (in dB) = (Power<sub>C1</sub> – 10 log BW<sub>C1</sub> (in Hz)) – (Power<sub>C2</sub> – 10 log BW<sub>C2</sub> (in Hz))  
 $= \text{CnC Ratio} - 10 \log (BW_{C1} / BW_{C2})$

If the two carriers have same Symbol Rate / Bandwidth, then the CnC Ratio is same as the PSD Ratio.

---

## G.6 Carrier-in-Carrier Automatic Power Control (CnC-APC)

### G.6.1 Overview

A number of Comtech EF Data modems, including the CDM-570A/AL, offer Automatic Uplink Power Control (AUPC) to mitigate the effects of rain fading and other link impairments.

It is important to note that the simple system employed in AUPC (whereby distant-end  $E_b/N_0$  is monitored, and local power is increased when a degraded link is detected) has an undesirable characteristic, which leads to some operators not permitting its use on their transponders: The inability of 'classic' AUPC to determine at which side of link the fade (or other impairment) has occurred. More specifically:

- If the fade is at the local side, all is well – the drop in  $E_b/N_0$  at the distant site corresponds exactly to the drop in power (due to excess attenuation) on the local uplink; when uplink power is increased, the power at the transponder does not exceed its clear-sky value.
- Conversely, if the fade occurs at the distant side, the AUPC system increases power in exactly the same way – but now, there is no excess uplink attenuation and, as a result, the clear-sky power at the satellite will be exceeded.

In a transponder with many carriers using AUPC, a fade event at the 'wrong' side can cause many carriers to simultaneously increase power beyond their authorized maximums, leading to intermod problems, adjacent channel interference (ACI) issues, and in some extreme cases, saturation of the transponder.

When considering power control in the Carrier-in-Carrier case, not only must the issue of exceeding allocated power limits be respected, but the problem of driving CnC ratios outside working limits during fading must also be taken into account.

### G.6.2 AUPC and Carrier-in-Carrier in the CDM-570A/AL

The CDM-570A/AL currently permits 'classic' AUPC when Carrier-in-Carrier mode is in operation, but this does nothing to stop the problem of exceeding power limits when the fade is on the 'wrong' side. To limit the impact of this, you are constrained to 3 dB of permitted power increase. Depending on the satellite band, and the depth and rapidity of the fade, this constraint may curtail the effectiveness of the system.

### G.6.3 The CnC Automatic Power Control Algorithm

In addressing the shortcomings of 'classic' AUPC, from its studies of the unique problems of power control in CnC systems, Comtech EF Data has determined that there is sufficient information available (CnC ratio, power level,  $E_b/N_0$ , RSL, etc.) on the local and distant sides to control power at each end without exceeding the total composite power allocated to each carrier in the CnC pair. Furthermore, the power control algorithm developed by Comtech EF Data ensures that the CnC ratio remains within the correct working range.

To recap, consider the following diagram:

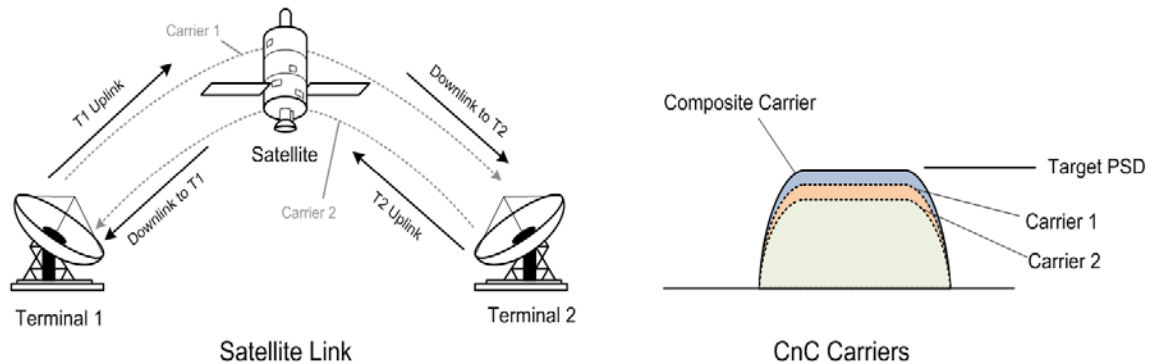

Whenever you adjust power on Carrier 1, you need to adjust the power in Carrier 2 so the composite carrier power remains constant (or does not exceed its allocated limit), while keeping the CnC ratio within limits.

There are two distinct phases to the CnC-APC algorithm:

1. In order for the CnC-APC algorithm to work effectively, it must first analyze the CnC Ratio and  $E_b/N_0$  margins on each side of the link, and based on the starting conditions, redistribute power between the two ends so that good protection against fades can be achieved. This process is referred as re-balancing, and is done so that total composite power (TCP) in the two carriers remains constant (within  $\pm 0.5$  dB).

In this process, both sides of the link calculate power changes, based on their ability to see not only local parameters, including CnC Ratio,  $E_b/N_0$ , Receive signal level, power level and max power increase, but those of the modem at the other end of the link. After these calculations are performed, a comparison of the results is performed, and if they are in close agreement, the power changes are implemented.

It may not always be possible to drive the powers to an optimum point. The calculations take into account:

- The minimum and maximum power levels possible in the modem (which is affected by the operating band – 70/140 MHz IF versus L-Band).
- If the user-programmed value that determines the maximum permitted increase in Tx power for the terminal would be exceeded. **This is a very important value**, and you must know exactly how far from compression his transmit RF chain is operating. As an example, if, under normal clear sky conditions, you determine that the backoff from compression is -3 dB, and under no circumstances must the RF chain ever go past -1 dB, the maximum power increase that can be permitted is 2 dB. You enter this into the CDM-570A/AL as a setup parameter. If this value is ignored, or incorrectly entered, compression or saturation could occur, either during the initial re-balance, or during a fade event. This parameter is referred to as  $TPLI_{max}$  (Transmit Power Level Increase, max).
- If the power changes calculated would put the CnC Ratio out of its working range.
- If the Rx signal level is above its minimum level – if it is not, the CnC Ratio monitor will not be accurate, which is essential correct calculations.

- If the power change would result in the Eb/No margin on either side becoming negative (see below).

At the end of the re-balance procedure, the modem will display the result:

- Full re-balance.
- Partial re-balance.
- Some issue was found that prevents a re-balance.

In the case of a partial or no re-balance, the modem displays the reason for this result; you can then adjust an operating parameter and try again.



**CAUTION – READ THESE IMPORTANT NOTES:**

- **You should be aware that after the re-balance has been carried out, it is very likely that the CnC Ratio will not be at 0dB, and the Eb/No margins will not be equal. This is particularly true for cases where there is an asymmetry in antenna size, terminal G/T, symbol rate etc. This is an inherent function of the re-balancing algorithm, and is not a cause for concern.**
- **You should only attempt to do a re-balance if it is known with certainty that there are CLEAR SKY conditions at BOTH SIDES OF THE LINK.**

**It is not necessary for there to be a person at each end – the re-balance can be initiated from either side, with the other side unattended.**

Following the re-balance, the CDM-570A/AL stores key parameters, such as Tx Power level, that are referred to as the **Home State**. In the event of a loss of communication between the two sides, the modem will revert to Home State, which is a known safe condition that will not cause TCP to be exceeded. Once the link conditions have improved so that communication is re-established, CnC-APC will automatically re-activate.

2. In the second phase of the algorithm, Eb/No, CnC ratio, and RSL are continuously monitored. For every combination of the modulation, FEC type and FEC code rate, the modem calculates an **Eb/No margin**. An Eb/No margin of 0 dB is arbitrarily determined to be the Eb/No value that produces a BER of  $1 \times 10^{-7}$  at the output of the decoder, plus 1 dB. If the algorithm senses that Eb/No margin is dropping, power is increased at one or both ends of the link, but in a manner that ensures that TCP is not exceeded. In the vast majority of cases the TCP during a fade will not exceed its clear-sky value by more than +0.5 dB.

The algorithm uses a number of inputs, from both sides of the link, including a knowledge of the satellite band in use (which you are required to know at the time of set-up). The characteristics of rain fading changes with frequency, and there are different models for C-Band, X-Band, Ku-Band, and Ka-Band. Not only does downlink attenuation vary as a function rain rate, but in some cases (depending on the G/T of the terminals at each end, and the satellite transponder itself) may be dominated by an increase in receive noise temperature when the antenna is pointing through rain and clouds, rather than 'cold' sky.

The depth of fade that the CnC-APC algorithm can tolerate is highly dependent on a number of factors, including:

- The CnC Ratio and Eb/No margins following a re-balance. In general, with a highly asymmetric link, where CnC Ratio is not close to zero, the tolerance to fade depth on one side will be less than the other.
- The maximum permitted level of power increase that you have defined. If, for example, you have programmed a TPLImax value of 2 dB (because that's the only headroom the RF chain has) you should not expect the link to tolerate a fast 10 dB fade at Ku-Band.

## G.6.4 CnC-APC Framing

In order to provide a two-way communications link between the two ends, CnC-APC requires an overhead channel (very much like EDMAC, or one of its variants, which is used in AUPC).

Recognizing that this overhead needs to have a minimal impact on occupied bandwidth and Eb/No performance, the overhead has been kept as low as possible:

- The overhead rate is fixed at 0.5%, causing the symbol rate of the carrier to grow by an almost imperceptible amount (no need to re-calculate channel spacing) and causing a loss of Eb/No performance of only 0.02dB.
- This choice of overhead rate effectively gives you the functionality of the CnC-APC channel without having to pay a penalty in power or bandwidth – it's essentially free.

The CnC-APC channel constantly passes a number of metrics and parameters, including CnC Ratio, Eb/No, Receive signal level, power level and max power increase, as well as information required for the initial set-up, including the modem operating band (L-Band or 70/140 MHz), and the satellite band in use.

In addition to the information fields in the frame, there is a control field that permits commands to be sent from one side or the other during initial re-balancing, and re-balancing during fade events.

Note that the CnC-APC frame size (and the latency associated with it) limits the lower end of the range of bit rates that are supported to 64 kbps. If you select the CnC-APC mode at a data rate below 64 kbps, an error message will be generated if a re-balance operation is requested.

## G.6.5 Solving the Problem of Self-Locking

Self-locking is a problem that has been previously reported to Comtech EF Data Product Support on CnC links that have identical data rates, FEC and modulation.

In the case where both ends of the link are up and running, the CnC canceller performs as intended. However, if the carrier at the remote side stops transmitting a carrier, the CnC canceller will still cancel the interferer (its own outbound Tx signal), but the cancelation is not perfect (it may be in the order -30 dB) and hence a weak signal appears at the input to the demodulator that, because of the correct settings of data rate, FEC and modulation, is sometimes acquired by the demod. This can sometimes be an issue because, although the Tx carrier from the distant side is not transmitting, no demodulator alarm is generated and hence the local end is not alerted – and data being transmitted is looped back to the receiver, and back into the network.



The use of CnC-APC framing provides the means to eliminate the self-locking problem. Rather than having an identical framing structure for the local and distant sides of the link, by designating each side as **Side A** and **Side B**, each side has a different framing structure and is therefore non-identical and incompatible. This makes it impossible for a modem in this CnC mode to lock to itself. With this approach, there is no 'master-slave' relationship – both sides are peers, and either side can be designated as **A** or **B**.

## G.6.6 CnC-APC Response Time

After CnC-APC is activated, power may be modified at a rate that does not exceed once every 1.75 seconds. This rate has been determined by taking into account the round trip satellite delay, the time taken to accurately determine CnC Ratio and Eb/No following a power adjustment, and the latency of the CnC-APC frame itself. The overall response time of the control system is therefore limited by these factors, and deep fading events that exceed approximately 1 dB/second are likely to be too fast for CnC-APC (or any other 'classic' scheme) to respond to. Users should bear in mind that these limitations in response time are inherent in schemes involving round-trip delays from geostationary satellites.

## G.6.7 CnC-APC Setup

To set up CnC-APC, carefully follow and understand the steps as presented here.



**CAUTION – This procedure should be done only when there are CLEAR SKY conditions at both ends of the link.**

1. Set up the CnC link in 'normal' mode according to the instructions earlier in this appendix, and according to an appropriately calculated link budget.

The initial selection of CnC-APC normally requires that a person be present at both ends, to coordinate the change of CnC from 'normal' to CnC-APC mode. Alternately, if an IP connection is available to the distant end that does not depend on the satellite link for primary connectivity, the setup can be performed remotely.

Once the link is established, a further re-balance, activation or suspension does not require another person to be present, or independent remote IP access.

2. Once the 'normal' CnC link has been established, determine that the link is stable and that it has an acceptable link margin at both ends.
3. Decide, arbitrarily, which is **Side A**, and which is **Side B**.

4. From the CDM-570A/AL front panel, select the **CONFIG: CnC → Mode** submenu. The appearance of the submenu differs as follows:

**CDM-570AL (L-Band):**

```
CnC Mode: Off On APC
Action      (< ▶, ENTER)
```

**CDM-570A (70/140 MHz):**

```
Mode: Off
```

For either unit, the available CnC selections are:

- Off
- On (normal)
- APC,Side-A,C-Band
- APC,Side-A,X-Band
- APC,Side-A,Ku-Band
- APC,Side-A,Ka-Band
- APC,Side-B,C-Band
- APC,Side-B,X-Band
- APC,Side-B,Ku-Band
- APC,Side-B,Ka-Band



**If it is not known which satellite band is in use, do not attempt to engage CnC-APC.**

**For the CDM-570AL only:** First, use the ◀ ▶ arrow keys to select CnC Mode as **APC**. Do not select **Action** at this time. Press **ENTER** when done. The nested APC screen appears:

```
APC: SideA C,X,Ku,Ka-band
SideB C,X,Ku,Ka-band < ▶
```

**On the top line:** Use the ◀ ▶ arrow keys to select the operating frequency for Side A: **C, X, Ku, or Ka-band**.

**On the bottom line:** Use the ◀ ▶ arrow keys to select the operating frequency for Side B: **C, X, Ku, or Ka-band**.

Press **ENTER** when done.

**For the CDM-570A only:** On the top line, use the ▲ ▼ arrow keys to select the specific CnC-APC mode – the screen appearance updates accordingly:

```
Mode: APC,Side-A, C-band
Act?N APC is not active
```

Press **ENTER** after selecting the Side A frequency, and then repeat the process to select the Side B frequency. Do not select **Act?** (Activate) as **Y** (Yes) at this time. Note the following:

- If **Side A** is selected at both sides, or **Side B** is selected at both sides, both modems will display a **Frame Sync** fault (under Rx faults). No further action is possible until this error has been corrected.

- If different satellite bands are selected on each side (for instance, Side A is Ku-Band, while side B is C-Band) the modem will display an **APC Band Mismatch** fault (under Rx faults). No further action is possible until this error has been corrected.

Based on the known RF terminal equipment in use, determine a value for the maximum allowed power increase ( $TPLI_{max}$ ) and then set this value. From the CDM-570A front panel, select the **CONFIG → Tx → Pwr** menu:

```
Output Power Level Mode:
Manual  AUPC  CnC-APC
```

With APC mode activated, CnC-APC is the only selectable mode. Press **ENTER** to continue to edit the Tx Pwr Level:

```
Tx Pwr Level: -35.0dBm
Max Pwr increase: 2.5dB
```

**To edit the power output level and the maximum permitted increase in power level when in CnC-APC Mode:** On the top line, use the ▲ ▼ arrow keys to select the value (in dB) as **-00.0**, **-10.0**, **-20.0**, or **-25.0**. Press **ENTER** when done.

Note that when APC is in an active state, the power level on the bottom line will read **'AUTO'**.

5. Go back to the **SELECT: CONFIG: CnC → MODE** menu.

**For the CDM-570AL only:** On the bottom line, select **Action** and then press **ENTER**. Then, use the ◀ ▶ arrow keys to select **Activate**.

```
CnC Mode:
Off On APC
Action
(◀
▶,ENTER)

▶

CnC-
APC: Activate
Suspend
APC is not
active
```

Press **ENTER** when done.

**For the CDM-570A only:** On the bottom line, select use use the ▲ ▼ arrow keys to select set **Act?** (Activate?) as **Y** or **N** (where **Y? N** is equivalent to **Suspend** for L-Band units).

```
Mode: APC,Side-A, C-band
Act?Y APC is not active
```

Press **ENTER** when done.

For either unit, the message on the bottom line can be any one of the following:

Displayed Message	Expanded Meaning
<b>OK-ReBalance Done</b>	Full re-balance was achieved
<b>OK(P)CnCRatio→Lim</b>	Partial re-balance, limited by CnC ratio approaching its working limit
<b>OK(P)-LocalPwr→Min</b>	Partial re-balance, limited by local power approaching its lower limit
<b>OK(P)-LocalPwr→Max</b>	Partial re-balance, limited by local power approaching its upper limit
<b>OK(P)-LocalPwr→Lim</b>	Partial re-balance, limited by local power approaching $TPLI_{max}$
<b>OK(P)-DistPwr→Min</b>	Partial re-balance, limited by distant power approaching its lower limit
<b>OK(P)-DistPwr→Max</b>	Partial re-balance, limited by distant power approaching its upper limit
<b>OK(P)-DistPwr→Lim</b>	Partial re-balance, limited by local power approaching $TPLI_{max}$
<b>OK(P)-Incomplete</b>	Partial re-balance, algorithm did not fully converge
<b>No APC Frame Sync</b>	Communication not possible – no APC frame sync
<b>Locl EbNo too high</b>	The local Eb/No is too high (>16 dB) to determine re-balance params
<b>Dist EbNo too high</b>	The distant Eb/No is too high (>16 dB) to determine re-balance params
<b>DistEnd ReBal fail</b>	The distant end failed to re-balance
<b>DistEnd NoResponse</b>	The distant end failed to respond
<b>Fail-CalcMismatch</b>	No Re-balance - the solution calculated by each end does not match
<b>CnC Ratio too high</b>	The CnC ratio is too high (>9 dB) for re-balancing to be attempted
<b>LoclMargin too low</b>	There is insufficient local Eb/No margin for an APC re-balance
<b>DistMargin too low</b>	There is insufficient local Eb/No margin for an APC re-balance
<b>Rx DataRate&lt;64kbps</b>	The Rx data rate needs to be 64 kbps or higher for APC
<b>Rx DataRate&lt;64kbps</b>	The Tx data rate needs to be 64 kbps or higher for APC
<b>Local RSL too low</b>	The local RSL is below the minimum for the operating symbol rate
<b>Dist RSL too low</b>	The distant RSL is below the minimum for the operating symbol rate

If the message shown begins with **OK**, then after approximately 5 seconds, the display changes as per the following example:

```
CnC-APC:Activate Suspend
No APC Frame Sync
```

At this point, as indicated on the bottom line of the display, CnC-APC is **active**.

To suspend CnC-APC at any time:

**CDM-570AL (L-Band):**

```
CnC-APC:Activate
Suspend
No APC Frame Sync
```

**CDM-570A (70/140 MHz):**

```
Mode: APC,Side-A, C-
band
Act?N APC is not active
```

**For the CDM-570AL only:** On the top line, use the ◀ ▶ arrow keys to select **Suspend**, and then press **ENTER**.

**For the CDM-570A only:** On the bottom line, use the ▲ ▼ arrow keys to select **Act?** (Activate?) as **N**(No), and then press **ENTER**.

The CnC-APC status message on the bottom line of the display will update accordingly, as per the following example:

```
Mode: APC,Side-A, C-band
Act?N APC is not active
```

Note that, when CnC-APC is suspended, it is de-activated on **both** sides.

If a message other than **OK** is displayed after attempting to perform a re-balance, the CnC-APC system will not activate, and you should correct the link conditions before re-attempting to activate it.



**CAUTION – READ THIS IMPORTANT NOTE:**

**YOU ARE NOT ALLOWED TO CHANGE CONFIGURATION PARAMETERS (MODULATION TYPE, FEC TYPE, CODE RATE, FRAMING, ETC) THAT POTENTIALLY AFFECT THE OPERATION OF CNC-APC WHILE CNC-APC IS ACTIVE. IF YOU ATTEMPT TO CHANGE ONE OF THESE PARAMETERS EITHER LOCALLY OR REMOTELY WHEN CNC-APC IS ACTIVE, THE MODEM REJECTS THE CHANGE. TO CHANGE THESE CONFIGURATION PARAMETERS, YOU MUST FIRST SUSPEND CNC-APC OPERATION. FOLLOWING ANY CHANGES, YOU MUST RE-ACTIVATE CNC-APC. BE AWARE THAT A NEW RE-BALANCE OPERATION PRECEDES CNC-APC RE-ACTIVATION.**

## G.6.8 CnC-APC Redundancy Support Notes

1. The CnC-APC feature fully supports 1:1 redundancy.
2. At this time, 1:N redundancy in the CRS-300/CRS-500 is not yet supported – a firmware update for these switches will be available in the future. Please consult Comtech EF Data Product Support for updated information.

## G.7 DoubleTalk Carrier-in-Carrier Specifications

Operating Mode	Requires the two links to share a common carrier frequency (Outbound and Inbound symbol rates do not have to be equal)						
Power Spectral Density Ratio and CnC Ratio	<p><b>BSPK/QPSK/8-PSK/8-QAM:</b> -7 dB to +11 dB (ratio of power spectral density, outbound interferer to desired inbound)</p> <p><b>16-QAM:</b> -7 dB to +7 dB (ratio of power spectral density, outbound interferer to desired inbound)</p> <p><b>Note:</b> With asymmetric carriers the absolute power ratio (or CnC ratio) would be different, depending on the ratio of the symbol rates.</p> <p><b>Example:</b></p> <ul style="list-style-type: none"> <li>• Outbound interferer = 1 Msymbols/sec</li> <li>• Desired Inbound = 500 ksymbols/sec</li> <li>• Ratio of power spectral density = +7 dB</li> </ul> <p>Absolute power ratio (<b>CnC Ratio</b>) = +7dB + (10 log Outbound/desired symbol rate) = +10 dB</p>						
Maximum Symbol Rate Ratio	3:1 (TX:RX or RX:TX)						
Inbound/Outbound frequency uncertainty	<p>Within the normal acquisition range of the demod, as follows:</p> <ul style="list-style-type: none"> <li>• <b>Below 64 ksymbols/sec:</b> <math>\pm 1</math> to <math>\pm (Rs/2)</math> kHz, where <math>Rs</math> = symbol rate in ksymbols/sec</li> <li>• <b>Between 64 and 389 ksymbols/sec:</b> <math>\pm 1</math> up to a maximum of <math>\pm 32</math> kHz</li> <li>• <b>Above 389 ksymbols/sec:</b> <math>\pm 1</math> to <math>\pm (0.1Rs)</math> kHz, up to a maximum of <math>\pm 200</math> kHz</li> </ul>						
Delay range	0-330 ms						
Eb/No Degradation (equal Inbound/Outbound power spectral density)	<table border="0"> <tr> <td>• BPSK = 0.3dB</td> <td>• QPSK = 0.3dB</td> <td>• OQPSK = 0.3dB</td> </tr> <tr> <td>• 8-PSK = 0.5dB</td> <td>• 8-QAM = 0.4dB</td> <td>• 16-QAM = 0.6dB</td> </tr> </table> <p>For +10 dB power spectral density ratio (outbound interferer 10 dB higher than desired inbound) add an additional 0.3 dB</p>	• BPSK = 0.3dB	• QPSK = 0.3dB	• OQPSK = 0.3dB	• 8-PSK = 0.5dB	• 8-QAM = 0.4dB	• 16-QAM = 0.6dB
• BPSK = 0.3dB	• QPSK = 0.3dB	• OQPSK = 0.3dB					
• 8-PSK = 0.5dB	• 8-QAM = 0.4dB	• 16-QAM = 0.6dB					
Monitor Functions	<ul style="list-style-type: none"> <li>• Delay, in milliseconds</li> <li>• Frequency offset (between outbound interferer and desired inbound). 100 Hz resolution</li> <li>• CnC ratio, in dB (ratio of absolute power, outbound interferer to desired inbound)</li> </ul>						
CnC Monitor Accuracy	$\pm 0.2$ dB for symmetric symbol rate						

---

## G.8 Carrier-in-Carrier Summary

Comtech EF Data's DoubleTalk Carrier-in-Carrier can provide significant savings in operational expenses. The following should be considered when evaluating DoubleTalk Carrier-in-Carrier:

- DoubleTalk Carrier-in-Carrier can only be used for full duplex links where the transmitting earth station is able to receive itself.
- DoubleTalk Carrier-in-Carrier can be used in both bandwidth limited and power limited situations.
- The maximum savings is generally achieved when the original link is symmetric in data rate.

---

## G.9 Glossary

---

### Bandwidth, Allocated or Occupied

---

Bandwidth or Allocated Bandwidth or Occupied Bandwidth is the frequency space required by a carrier on a transponder.

**For example:** A 5 Mbps Carrier with 8QAM Modulation, FEC Rate 0.78 and 1.1 Spacing requires:

- Allocated BW =  $(DR / SE) * CSF$  [(Data Rate / Spectral Efficiency) \* Carrier Spacing Factor]
- Allocated BW = 2.35 MHz =  $(5 / 2.34) * 1.1$

For a 36 MHz transponder, 2.53 MHz corresponds to 6.53% Bandwidth Utilization.

---

### Bandwidth, Leased (LBW)

---

Almost all satellite operators charge for the Leased Bandwidth (LBW). Leased Bandwidth or Leased Resource is the greater of the Allocated Bandwidth and Power Equivalent Bandwidth.

**For example:** If a carrier requires 2 MHz of Allocated BW and 4.1 MHz of PEB, the Leased Bandwidth is 4.1 MHz

---

### Bandwidth, Power Equivalent (PEB)

---

Power Equivalent Bandwidth (PEB) is the transponder power used by a carrier, represented as bandwidth equivalent.

**PEB Calculation Example:**

- Transponder EIRP = 37 dBW
- Output Backoff (OBO) = 4 dB
- Available EIRP =  $37 - 4 = 33$  dBW =  $10^{3.3} = 1995.26$  Watts
- Transponder Bandwidth = 36 MHz
- Power Available / MHz =  $1995.26 / 36 = 55.424$  W
- If a carrier uses 21 dBW, its PEB =  $10^{2.1} / 55.424 = 2.271$  MHz

This corresponds to 6.31% of available transponder power.



## CnC Ratio

---

### Ratio of Interfering Carrier Power to Desired Carrier Power (unit in dB).

The Interfering Carrier is the Tx Carrier from local modulator; the Desired Carrier is the carrier from the distant end received by the local demodulator.

**At the station transmitting C1:** CnC Ratio (in dB) = PowerC1 (in dBm) – PowerC2 (in dBm)

## Eb/No

---

### Ratio of Energy per bit (Eb) to Noise density (No) (unit in dB):

- $E_b/N_o = C/N_o - 10\log(DR)$  [where DR is the Data Rate]
- $E_b/N_o = E_s/N_o - 10\log(SE)$  [where SE is Spectral Efficiency]

## Es/No

---

### Ratio of Energy per symbol (Es) to Noise density (No) (unit in dB):

- $E_s/N_o = C/N_o - 10\log(SR)$  [where SR is the Symbol Rate]
- $E_s/N_o = E_b/N_o + 10\log(SE)$  [where SE is Spectral Efficiency]

## C/N

---

### Ratio of Carrier Power (C) to Noise (N) (unit in dB):

Equivalent to Es/No when calculated in the Symbol Rate bandwidth.

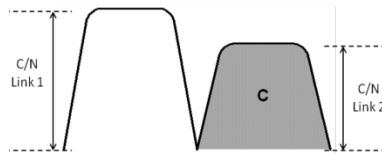

## C/No

---

### Ratio of Carrier Power (C) to Noise Density (No) (unit in dBHz)

## Co+No/No

---

### Ratio of Carrier Density (Co) + Noise (No) to Noise Density (No) (unit in dB):

$C/N = C/N_o - 10\log(B)$  [where B is bandwidth in Hz]

$E_b/N_o = C/N_o - 10\log(DR)$  [where DR is data rate in bits/sec]

$$= C/N + 10\log(B) - 10\log(DR)$$

$$= C/N - 10\log(SE)$$
 [where SE is Spectral Efficiency]

$E_b/N_o = 10\log(10^{((C_o+N_o/N_o)/10)} - 1) - 10\log(SE)$  [where SE is Spectral Efficiency]

[Note: Spectral Efficiency is in bps / Hz]

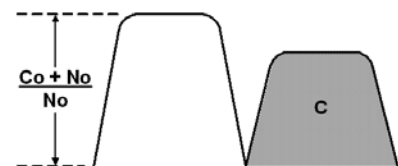

## Power Spectral Density (PSD)

---

**Power Spectral Density (PSD)** is the signal power per unit bandwidth: dBW / Hz or dBm / Hz

**For example:** Signal power = 20 dBm

Signal bandwidth = 2.5 MHz

$PSD = 20 - 10 * \log (2,500,000) = -43.98 \text{ dBm} / \text{Hz}$

## PSD Ratio

---

**Ratio of Power Spectral Density (PSD) of the interfering carrier to the desired carrier.**

If looking at the two carriers side-by-side on a spectrum analyzer:

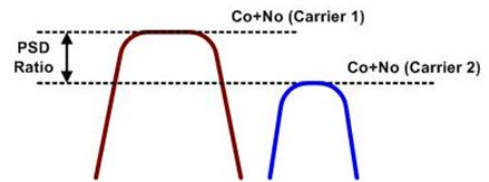

## Quasi Error Free (QEF)

---

Quasi Error Free (QEF) corresponds to PER  $\sim 10^{-7}$

[Note: PER (packet error rate) is based upon a 188-byte MPEG frame size]

## Spectral Efficiency (SE)

---

**Ratio of the Data Rate to the Symbol Rate.**

## Symbol Rate & Data Rate

---

**Symbol Rate and Data Rate are related:**

- $DR = SR * SE$  [Data Rate = Symbol Rate \* Spectral Efficiency]
- $SR = DR / SE$  [Symbol Rate = Data Rate / Spectral Efficiency]

# Appendix H. $E_b/N_0$ MEASUREMENT

Although the CDM-570A/570AL calculates and displays the value of receive  $E_b/N_0$  on the front panel of the unit, it is sometimes useful to measure the value using a spectrum analyzer, if one is available.

The idea is to accurately measure the value of  $(C_0+N_0)/N_0$  (Carrier density + Noise density/Noise density). This is accomplished by tuning the center frequency of the Spectrum analyzer to the signal of interest, and measuring the difference between the peak spectral density of the signal (the flat part of the spectrum shown) and the noise density.

To make this measurement:

- Use a vertical scale of 1 or 2 dB/division.
- Set the Resolution Bandwidth of the Spectrum Analyzer to < 20% of the symbol rate.
- Use video filtering and/or video averaging to reduce the variance in the displayed trace to a low enough level that the difference can be measured to within 0.2 dB.
- Place a marker on the flat part of the signal of interest, then use the MARKER DELTA function to put a second marker on the noise to the side of the carrier. This value is  $(C_0+N_0)/N_0$ , in dB.
- Use this value of  $(C_0+N_0)/N_0$  in the table on the following page to determine the  $E_b/N_0$ . You will need to know the operating mode to read from the appropriate column.
- If the  $(C_0+N_0)/N_0$  value measured does not correspond to an exact table entry, interpolate using the two nearest values.



**The accuracy of this method degrades significantly at low values of  $(C_0+N_0)/N_0$  (approximately less than 6 dB).**

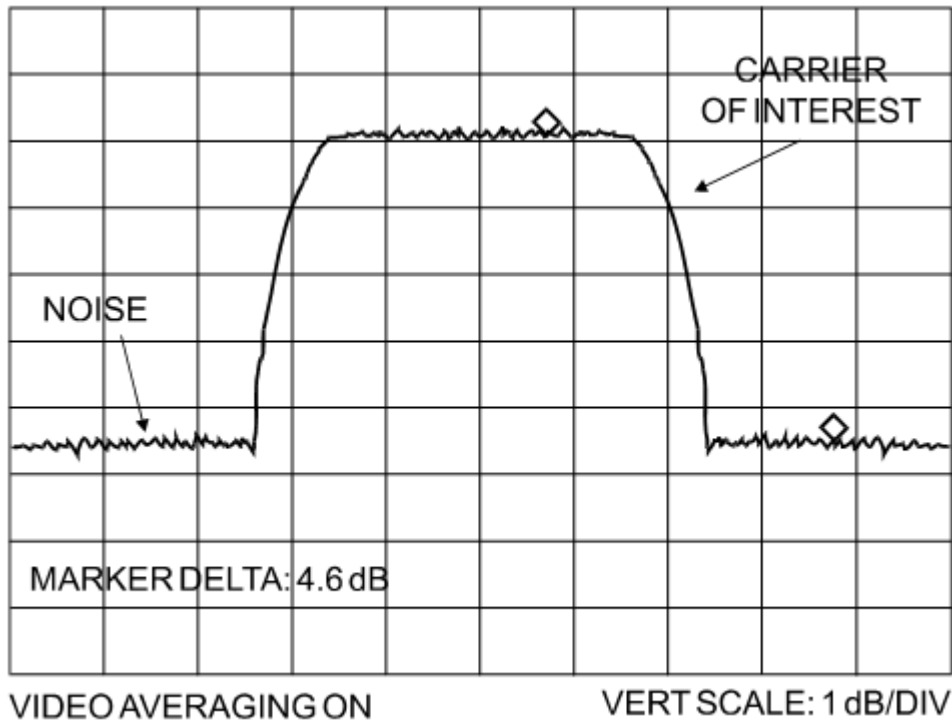

**Example:** In the above diagram, the  $(C_o+N_o)/N_o$  measured is 4.6 dB. If Rate 1/2 QPSK is being used, this would correspond to an  $E_b/N_0$  of approximately 2.6 dB.

The exact relationship used to derive the table values is as follows:

$$E_b/N_0 = 10 \log_{10} (10^{(C_o+N_o/N_o)/10} - 1) - 10 \log_{10} (\text{FEC Code Rate}) - 10 \log_{10} (\text{bits/symbol})$$

Where:

- $E_b/N_0$  and  $(C_o+N_o)/N_o$  are expressed in dB
- Bits/symbol = 1 for BPSK
- Bits/symbol = 2 for QPSK
- Bits/symbol = 3 for 8-PSK/8-QAM
- Bits/symbol = 4 for 16-QAM
- Code Rate for 'uncoded' = 1



**Pay close attention to the sign of the middle term.**

(Co+No)/No	Eb/No Uncoded BPSK	Eb/No Rate 1/2 BPSK	Eb/No Rate 21/44 BPSK	Eb/No Rate 5/16 BPSK	Eb/No Uncoded QPSK	Eb/No Rate 1/2 QPSK	Eb/No Rate 3/4 QPSK	Eb/No Rate 7/8 QPSK	Eb/No Rate 0.95 QPSK	Eb/No Rate 2/3 8-PSK	Eb/No Rate 3/4 8-PSK	Eb/No Rate 7/8 8-PSK	Eb/No Rate 0.95 8-PSK	Eb/No Rate 3/4 16-QAM	Eb/No Rate 7/8 16-QAM
1.4	-	-	-	0.8	-	-	-	-	-	-	-	-	-	-	-
1.6	-	-	-	1.5	-	-	-	-	-	-	-	-	-	-	-
1.8	-	-	-	2.1	-	-	-	-	-	-	-	-	-	-	-
2.0	-	0.7	0.9	2.7	-	-	-	-	-	-	-	-	-	-	-
2.2	-	1.2	1.4	3.2	-	-	-	-	-	-	-	-	-	-	-
2.4	-	1.7	1.9	3.7	-	-	-	-	-	-	-	-	-	-	-
2.6	-	2.1	2.3	4.2	-	-	-	-	-	-	-	-	-	-	-
2.8	-	2.6	2.8	4.6	-	-	-	-	-	-	-	-	-	-	-
3.0	0.0	3.0	3.2	5.0	-	-	-	-	-	-	-	-	-	-	-
3.5	0.9	3.9	4.1	5.9	-	0.9	-	-	-	-	-	-	-	-	-
4.0	1.8	4.8	5.0	6.8	-	1.8	-	-	-	-	-	-	-	-	-
4.5	2.6	5.6	5.8	7.6	-	2.6	0.8	-	-	-	-	-	-	-	-
5.0	3.3	6.3	6.5	8.4	-	3.3	1.5	0.9	-	-	-	-	-	-	-
5.5	4.1	7.1	7.3	9.1	1.1	4.1	2.3	1.7	1.3	-	-	-	-	-	-
6.0	4.7	7.7	7.9	9.8	1.7	4.7	2.9	2.3	1.9	-	-	-	-	-	-
6.5	5.4	8.4	8.6	10.4	2.4	5.4	3.6	3.0	2.6	-	-	-	-	-	-
7.0	6.0	9.0	9.2	11.1	3.0	6.0	4.2	3.6	3.2	-	-	-	-	-	-
7.5	6.6	9.6	9.8	11.7	3.6	6.6	4.8	4.2	3.8	-	-	-	-	-	-
8.0	7.3	10.3	10.5	12.3	4.3	7.3	5.5	4.9	4.5	-	-	-	-	-	-
8.5	7.8	10.8	11.0	12.9	4.8	7.8	6.0	5.4	5.0	4.8	-	-	-	-	-
9.0	8.4	11.4	11.6	13.4	5.4	8.4	6.6	6.0	5.6	5.4	4.9	-	-	-	-
9.5	9.0	12.0	12.2	14.0	6.0	9.0	7.2	6.6	6.2	6.0	5.5	4.8	-	-	-
10.0	9.5	12.5	12.7	14.6	6.5	9.5	7.7	7.1	6.7	6.5	6.0	5.3	5.0	-	-
10.5	10.1	13.1	13.3	15.1	7.1	10.1	8.3	7.7	7.3	7.1	6.6	5.9	5.6	5.3	-
11.0	10.6	13.6	13.8	15.7	7.6	10.6	8.8	8.2	7.8	7.6	7.1	6.4	6.1	5.8	5.2
11.5	11.2	14.2	14.4	16.2	8.2	11.2	9.4	8.8	8.4	8.2	7.7	7.0	6.7	6.4	5.8
12.0	11.7	14.7	14.9	16.7	8.7	11.7	9.9	9.3	8.9	8.7	8.2	7.5	7.2	6.9	6.3
12.5	12.2	15.2	15.4	17.3	9.2	12.2	10.4	9.8	9.4	9.2	8.7	8.0	7.7	7.4	6.8
13.0	12.8	15.8	16.0	17.8	9.8	12.8	11.0	10.4	10.0	9.8	9.3	8.6	8.3	8.0	7.4
13.5	13.3	16.3	16.5	18.3	10.3	13.3	11.5	10.9	10.5	10.3	9.8	9.1	8.8	8.5	7.9
14.0	13.8	16.8	17.0	18.8	10.8	13.8	12.0	11.4	11.0	10.8	10.3	9.6	9.3	9.0	8.4
14.5	14.3	17.3	17.5	19.4	11.3	14.3	12.5	11.9	11.5	11.3	10.8	10.1	9.8	9.5	8.9
15.0	14.9	17.9	18.1	19.9	11.9	14.9	13.1	12.5	12.1	11.9	11.4	10.7	10.4	10.1	9.5
15.5	15.4	18.4	18.6	20.4	12.4	15.4	13.6	13.0	12.6	12.4	11.9	11.2	10.9	10.6	10.0
16.0	15.9	18.9	19.1	20.9	12.9	15.9	14.1	13.5	13.1	12.9	12.4	11.7	11.4	11.1	10.5
16.5	16.4	19.4	19.6	21.4	13.4	16.4	14.6	14.0	13.6	13.4	12.9	12.2	11.9	11.6	11.0
17.0	16.9	19.9	20.1	21.9	13.9	16.9	15.1	14.5	14.1	13.9	13.4	12.7	12.4	12.1	11.5
17.5	17.4	20.4	20.6	22.4	14.4	17.4	15.6	15.0	14.6	14.4	13.9	13.2	12.9	12.6	12.0
18.0	17.9	20.9	21.1	23.0	14.9	17.9	16.1	15.5	15.1	14.9	14.4	13.7	13.4	13.1	12.5
18.5	18.4	21.4	21.6	23.5	15.4	18.4	16.6	16.0	15.6	15.4	14.9	14.2	13.9	13.6	13.0
19.0	18.9	21.9	22.1	24.0	15.9	18.9	17.1	16.5	16.1	15.9	15.4	14.7	14.4	14.1	13.5
19.5	19.5	22.5	22.7	24.5	16.5	19.5	17.7	17.1	16.7	16.5	16.0	15.3	15.0	14.7	14.1
20.0	20.0	23.0	23.2	25.0	17.0	20.0	18.2	17.6	17.2	17.0	16.5	15.8	15.5	15.2	14.6

Notes: IBS Framing: add 0.2 dB EDMAC Framing: rates below 2048 kbps add 0.2 dB, otherwise 0 Reed-Solomon: add an additional 0.4 dB to the values shown



# Appendix I. RADIUS CLIENT

---

## I.1 Overview

Ethernet-based remote monitor and control (M&C) of the CDM-570A/570AL Satellite Modem is available through the CDM-570A/570AL HTTP (Web Server) Interface, SNMP, and through the issuance of remote commands and queries via Telnet.

For CDM-570A/570AL Satellite Modems that are equipped with the Optional IP Packet Processor, additional remote M&C access is available via the Telnet Command Line Interface (CLI).

Remote Authentication Dial In User Service (RADIUS) is a networking protocol that provides centralized access authentication, authorization, and management for CDM-570A/570AL Satellite Modems.

### I.1.1 RADIUS List of Supported RFCs (Requests for Comment)

RFC No.	Description
2865	"Remote Authentication Dial In User Service (RADIUS)" Rigby, C., Willens, S., Rubens, A., Simpson, W., June 2000
1334	"PPP Authentication Protocols" Lloyd, B., Simpson, W., October 1992
1994	"PPP Challenge Handshake Authentication Protocol (CHAP)" Simpson, W., August 1996
2759	"Microsoft PPP CHAP Extensions, Version 2" Zorn, G., January 2000
2548	"Microsoft Vendor-specific RADIUS Attributes" Zorn, G., March 1999

## I.2 Service Types

“Service Type” is the attribute field in the “RADIUS Access Request and RADIUS Access Response” message as defined in RFC 2865. This attribute indicates the type of service the user has requested, or the type of service to be provided.

CDM-570A/570AL RADIUS client recognizes the following value fields, as assigned to the service type attribute in **RADIUS: Access-Accept** messages received from the RADIUS server, and sets access levels accordingly:

Value	Description	Access Level
6	Administrative	Admin Read write
7	NAS Prompt	Read -only
11	Callback Administrative	Read/Write access



**Some RADIUS Servers might need to be reconfigured with the above service type values for corresponding user access levels.**

## I.3 RADIUS Client



**Figure I-1. RADIUS Authentication Process**

**Figure I-1** shows the typical RADIUS connectivity with the CDM-570A/570AL Satellite Modem. Remote monitor and control of the CDM-570A/570AL Satellite Modem is accomplished with the User PC. The Modem connects to the RADIUS Server for user credential authentication. The authentication process, as shown here, permits use of the HTTP (Web Server) Interface for remote M&C of the CDM-570A/570AL. This basic messaging sequence is the same for M&C access to the CDM-570A/570AL over the Telnet user interface:



Step	Action
1	The User PC transmits the "HTTP GET" request.
2	Upon receiving the "HTTP GET" request, the CDM-570A/570AL checks whether the user has been authenticated. If not, the CDM-570A/570AL returns "HTTP 401 Unauthorized" message to the User PC.
3	The User PC transmits the login credentials to the CDM-570A/570AL using the "HTTP GET" message.
4	<p>The CDM-570A/570AL receives the login credentials and performs the following steps:</p> <ul style="list-style-type: none"> <li>A. It validates the login credentials against the locally stored Admin credentials. If the credentials match, the modem allows Read/Write access (including Admin configuration pages); it does not grant RADIUS access.</li> <li>B. If there is no match for the system user credentials, then the modem transmits the <b>RADIUS: Access-Request</b> message to the Primary RADIUS Server.</li> <li>C. If the Primary RADIUS Server is not available, then the modem transmits the <b>RADIUS: Access-Request</b> message to the Secondary RADIUS Server.</li> <li>D. If the Secondary RADIUS Server is not available, then the modem transmits the <b>HTTP: Access Denied</b> message (error page) to the User PC.</li> </ul>
5	<p>The RADIUS Server, upon receiving the <b>RADIUS:Access-Req</b> message, authenticates the user credentials and does one of the following:</p> <ul style="list-style-type: none"> <li>A. It transmits the <b>RADIUS: Access-Accept</b> message with the appropriate user access level – e.g., <i>Read-only</i> or <i>Read/Write</i>.</li> <li>B. It transmits the <b>RADIUS:Access-Reject</b> message upon credential mismatch.</li> <li>C. It transmits the <b>RADIUS: Access-Challenge</b> for further validation.</li> </ul>
6	<p>The CDM-570A/570AL, upon receiving one of the above responses from the RADIUS server, then does one of the following:</p> <ul style="list-style-type: none"> <li>A. Upon receiving the <b>RADIUS:Access-Accept</b> message, it transmits the "HTTP 201 OK" message to the User PC.</li> <li>B. Upon receiving the <b>RADIUS: Access-Reject</b> message, it transmits the "Access Denied" message to the User PC.</li> <li>C. Upon receiving the <b>RADIUS: Access-Challenge message</b>, it transmits the "PAP/CHAP challenge response" message to the Radius Server.</li> </ul>
7	<p>Upon receiving the "HTTP 201 OK" message, the user can browse the CDM-570A/570AL HTTP (Web Server) Interface pages.</p> <p> Depending on the user access rights received from the RADIUS server, the CDM-570A/570AL allows the user Read-only or Read-Write access to the interface.</p>

## I.4 RADIUS Operation and Configuration

RADIUS is available only when you configure the CDM-570A/570AL for **IP** or **IP-ACM** operating mode. Enabling and disabling of RADIUS is possible only through:

- The CDM-570A/570AL front panel;
- The CDM-570A/570AL HTTP (Web Server) Interface **Admin | Access** page;
- Issuance of Telnet remote commands.

With RADIUS enabled, any login attempt through the HTTP, Telnet, or Telnet CLI interfaces results in the modem first contacting the RADIUS Client Server for authentication and authorization before granting remote user access. Comtech EF Data provides three levels of user access/login – Admin, Read/Write, and Read Only. Access to operations is controlled as follows:

User Access Login Level	Access Restriction(s)
Admin User (system*)	<b><i>Full read/write access</i></b> to all remote commands and queries via Telnet, Telnet CLI (when unit is equipped with the Optional IP Packet Processor), and web pages (including RADIUS configuration and control using the <b>Admin   Access</b> web page).
Read/Write User	<ul style="list-style-type: none"> <li>• <b>No Access</b> to Admin- or IP Packet Processor-related Telnet remote commands and queries, Telnet CLI, and web pages.</li> <li>• <b>Full read/write access</b> to all modem configuration and monitoring web pages (except Admin).</li> </ul>
Read-Only User	<ul style="list-style-type: none"> <li>• <b>No Access</b> to Admin or IP Packet Processor-related web pages, Telnet remote commands and queries, or Telnet CLI.</li> <li>• <b>Read Only Access</b> for all other web pages.</li> </ul>



- **RADIUS does not control user access to the CDM-570A/570AL Front Panel, serial-based remote product management, or the SNMP user interface.**
- **\*System administration under the Admin User login privilege does not require RADIUS.**
- **Admin User credentials are stored in the modem, so login as Admin User does not require the RADIUS Server connectivity.**
- **SNMP access can be disabled using System Admin access.**

Configuration of RADIUS features is possible only through the HTTP (Web Server) Interface **Admin | Access** page, or by issuance of remote commands via Telnet. No configuration of RADIUS is available from the CDM-570A/570AL front panel or through serial-based remote commands, SNMP, or the Telnet CLI.

The modem is configurable with primary and secondary RADIUS server addresses. In the event that the primary server is unavailable, the secondary server will be used to validate the user name and password.

Read/write and read-only user credentials are managed via the RADIUS Client Server – the RADIUS Client Server cannot grant Admin level access. The modem locally stores one Admin-level user name and password. If the RADIUS client is disabled or the modem cannot access the primary and the secondary server, any user trying to access the modem will be authenticated with the locally stored username and password, which provides full Admin access.



- **All user credentials are verified by the RADIUS server, when the client has connectivity to either the primary or secondary RADIUS servers.**
- **In the absence of primary or secondary RADIUS server connectivity, or when RADIUS is disabled, the locally stored Admin credentials are used for modem access.**

#### I.4.1 RADIUS M&C using the CDM-570A/570AL HTTP (Web Server) Interface



#### Chapter 7. ETHERNET-BASED REMOTE PRODUCT MANAGEMENT



The Admin pages are available only if you log in using the Administrator Name and Password.

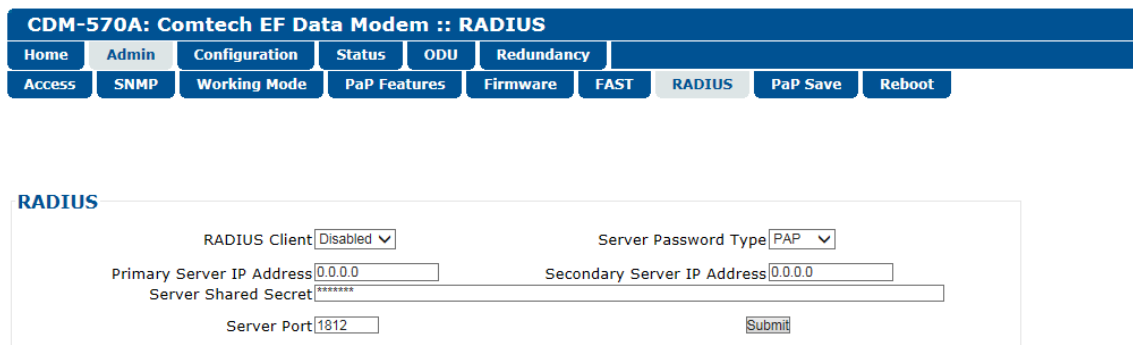

The screenshot shows the RADIUS configuration page. At the top, there is a navigation bar with the following tabs: Home, Admin, Configuration, Status, ODU, Redundancy, Access, SNMP, Working Mode, PaP Features, Firmware, FAST, RADIUS (selected), PaP Save, and Reboot. The RADIUS configuration form includes the following fields:

- RADIUS Client: Disabled (dropdown menu)
- Server Password Type: PAP (dropdown menu)
- Primary Server IP Address: 0.0.0.0 (text input)
- Secondary Server IP Address: 0.0.0.0 (text input)
- Server Shared Secret: \*\*\*\*\* (password field)
- Server Port: 1812 (text input)
- Submit button

Figure I-2. CDM-570A/570AL HTTP (Web Server) Interface Admin | RADIUS Page

- **RADIUS Client** – Use the drop-down list to set RADIUS operation as **Enabled** or **Disabled**.
- **Server Password Type** – Use the drop-down list to select the authentication protocol as PAP (Password Authentication Protocol) or CHAP (Challenge-Handshake Authentication Protocol).
- **Primary / Secondary Server IP Address** – Enter the pertinent Server IP Addresses in the form **xxx.xxx.xxx.xxx**.
- **Server Shared Secret** – **Carefully** enter the word to be used (64 characters maximum) as the "shared secret" between the RADIUS Client Server and the networked device (CDM-570A/570AL). The interface conceals this entry for security purposes.
- **Server Port** – Enter a valid port number from **1** to **65535** (the default is **1812**).

Click [**Submit Radius**] to save.

- **RADIUS Log** – This scrollable window displays the last 20 users who have logged onto the RADIUS server.

## I.4.2 RADIUS M&C Using Telnet



- Chapter 7. ETHERNET-BASED REMOTE PRODUCT MANAGEMENT
- Chapter 8. SERIAL-BASED REMOTE PRODUCT MANAGEMENT



The RADIUS commands/queries are available only if you log in to the Telnet Remote Control Interface (not to be confused with the Telnet CLI – Command Line Interface) using the Administrator Name and Password.

Command/Query	Function
RAE	Enables/Disables RADIUS operation
RAA	Assigns the Primary RADIUS Client Server IP Address
RAB	Assigns the Secondary RADIUS Client Server IP Address
RAP	Assigns the RADIUS Server Port Address
RAT	Defines the RADIUS Client Server password authentication protocol
RAS	Assigns the RADIUS Client Server shared secret

# Appendix J. EDMAC CHANNEL

---

## J.1 Theory of Operation

### J.1.1 EDMAC, EDMAC-2

The Embedded Distant-end Monitor And Control (EDMAC) feature permits user access to the M&C features of modems that are at the distant-end of a satellite link. This is accomplished by adding extra information to your data, but in a manner that is otherwise transparent.

#### **On the transmit side:**

The data is split into frames – each frame containing 1008 bits (except Rate 21/44 BPSK Turbo, or when the data rates exceed 2048 kbps, where the frame length is 2928 bits, and Rate 5/16 BPSK Turbo where the frame length is 3072 bits). There are 48 bits in each frame are overhead, and the rest of these bits are user data. This increases the rate of transmission by 5% (approximately 1.5% for the Turbo BPSK cases, and for all data rates greater than 2.048 Mbps). For example, if the user data rate is 64 kbps, the actual transmission rate will now be at 67.2 kbps. Note that you may also select EDMAC-2 framing, which always uses a 2928 bit frame, and yields a 1.6% overhead for all modulation types and data rates.

At the start of each frame, a 12-bit synchronization word is added. This allows the demodulator to find and lock to the start of frame. At regular intervals throughout the frame, additional data bytes and flag bits are added (a further 36 bits in total). It is these additional bytes that convey the M&C data.

When framing is used, the normal V.35 scrambler is no longer used. This V.35 approach is called 'self synchronizing' because no external information is required in the receiver in order for the de-scrambling process to recover the original data.

The disadvantage of this method is that it multiplies errors. On average, if one bit error is present at the input of the descrambler, three output errors are generated. However, there is an alternative when the data is in a framed format: in this case, a different class of scrambler may be used – one that uses the start of frame information to start the scrambling process at an exact known state.

In the receiver, having synchronized to the frame, the de-scrambler can begin its processing at exactly the right time. This method does not multiply errors, and therefore has a clear advantage over V.35 scrambling. This is fortunate, as there is a penalty to be paid for adding the framing: by adding the extra 5% to the transmitted data rate, the effective  $E_b/N_0$  that is seen will degrade by a factor of  $10\log(1.05)$ , or 0.21 dB (0.07dB in the case of the two BPSK Turbo rates or EDMAC-2).

The use of an externally synchronized scrambler and descrambler almost exactly compensates for this degradation. The net effect is that you will see effectively identical BER performance, whether or not framing is used.

#### **On the receive side:**

When the demodulator locks to the incoming carrier, it must go through the additional step of searching for and locking to the synchronization word. This uniquely identifies the start of frame, and permits the extraction of the overhead bytes and flag bits at the correct position within the frame. Additionally, the start of frame permits the de-scrambler to correctly recover the data: your data is extracted and sent through additional processing in the normal manner. The extracted overhead bytes are examined to determine if they contain valid M&C bytes.

---

## **J.2 M&C Connection**

Data to be transmitted to the distant-end is sent to a local unit via the remote control port. A message for the distant-end is indistinguishable from a 'local' message – it has the same structure and content, only the address will identify it as being for a distant-end unit.

Before the M&C data can be successfully transmitted and received, pairs of units must be split into EDMAC Masters and EDMAC Slaves. Masters are local to the M&C Computer, and Slaves are distant-end.

Now, a unit that has been designated an EDMAC master not only responds to its own unique bus address, but it will also be configured to listen for the address that corresponds to its EDMAC Slave. When a complete message packet has been received by the EDMAC Master, it will begin to transmit this packet over the satellite channel, using the overhead bytes that become available.



**The 'normal' protocol for the message packet is not used over the satellite path, as it is subject to errors. For this reason, a much more robust protocol is used which incorporates extensive error checking.**

At the distant-end, the EDMAC slave, configured for the correct address, receives these bytes, and when a complete packet has been received, it will take the action requested, and then send the appropriate response to the EDMAC Master, using the return overhead path on the satellite link. The EDMAC Master assembles the complete packet, and transmits the response back to the M&C Computer.

Apart from the round-trip satellite delay, the M&C Computer does not see any difference between local and distant-end units – it sends out a packet, addressed to a particular unit, and gets back a response. It can be seen that the EDMAC Master simply acts as forwarding service, in a manner that is completely transparent.

This approach does not require any additional cabling; connection is made using the normal M&C remote port, which is completely independent from the modem data port. Consequently, you do not have to worry about configuring the baud rate of the M&C connection to match the lowest data rate modem in the system. It should be pointed out that, at 2.4 kbps, the effective throughput of the overhead channel is only 14 asynchronous characters/second. For a message of 24 bytes, the time between sending a poll request and receiving a response will be around 1.7 seconds. (Note that, when EDMAC-2 or either of the BPSK Turbo rates is in use, the overhead rate is reduced by a factor of three, and therefore the minimum response time will be around 5 seconds.)

---

## J.3 Setup Summary

To access a distant-end unit:

- Designate a Master/Slave pair: Master at the local-end, Slave at the distant-end.
- On the local-end unit, enable framing and EDMAC, define the unit as MASTER, then enter the bus address. This is constrained to be 'base 10' meaning that only addresses such as 10, 20, 30, 40 etc, are allowed.
- Choose a unique bus address for the distant-end. This should normally be set to the 'base 10' address + 1. For example, if the MASTER unit is set to 30, choose 31 for the distant-end unit.
- On the distant-end unit, enable framing and EDMAC, define the unit as SLAVE, then enter the bus address. The orange EDMAC Mode LED on the modem front panel should be illuminated.
- Set the local-end unit to RS485 remote control, and set the bus address of this local unit. The orange Remote Mode LED on the modem front panel should be illuminated.
- Once the satellite link has been established, connect the M&C Computer, and begin communications with both the local and distant end units.



**EDMAC modes are fully compatible with AUPC modes.**





# Appendix K. GPS MODE

## K.1 Overview

This appendix summarizes the CDM-570A/570AL firmware feature that permits connection of a Furuno GP-320B Global Positioning System (GPS) receiver to a distant-end modem, and for the local end to query – via the EDMAC channel – the output from the GPS receiver.

To do this, the local modem is set as MASTER, and the distant-end is set as SLAVE. The Furuno GP-320B GPS receiver is then connected to the rear panel “Remote Control” serial port of the distant end modem.



**If ‘standard’ EDMAC framing is used, the MASTER can be a CDM-550, CDM-600/600L, CDM-570/570L, or CDM-570A/570AL. However, if EDMAC-2 framing is used, both ends of the link need to be CDM-570A/570ALs.**

Send remote commands to the SLAVE modem to retrieve GPS data sentences. The modem has a circular buffer to contain the most recent 1000 characters received from the GPS receiver – about 2 to 3 seconds of data. The method of searching for the correct sentence is to simply look for the first match in the buffer. This gives about two seconds’ delay time in the worst case at the SLAVE end, plus any delay added by the EDMAC channel. When a query is actively taking place, the CDM-570A/570AL temporarily suspends the placing of new GPS data into the buffer.

## K.2 Hardware Setup

Step	Task
1	Make sure to set the serial remote control type for the SLAVE modem to RS232.
2	Follow the Setup sequence of EDMAC described in <b>Appendix G. EDMAC CHANNEL</b> . The SLAVE Modem must be a CDM-570 or CDM-570L, and the MASTER modem can be any modem compatible with the SLAVE modem.
3	Connect the GP-320B GPS receiver to the SLAVE modem’s serial port. The <b>YELLOW</b> wire in the Furuno GPS cable (RDA) should be connected to pin 3 of the CDM-570L serial remote control port (9-pin Type ‘D’ male – see <b>Chapter 3. REAR PANEL CONNECTORS AND PINOUTS</b> ). Connect the ground wire from the GPS to Pin 1.
4	Establish an RF link between the SLAVE and MASTER modems, and once satisfied that both demods are locked, set up a serial communications session via the serial port of the MASTER modem, and begin sending EDMAC messages to the distant-end SLAVE.

## K.3 Remote Commands



For more information about using remote commands and queries, see Chapter 8. SERIAL-BASED REMOTE PRODUCT MANAGEMENT.

Several remote commands are available to enable the GPS Mode and retrieve GPS information. These commands are for the SLAVE modem ONLY, which means the address field must be the address of the Slave unit (e.g., 0021).

- **GPS – GPS Mode, Query and Command**
  - 0 = Disabled
  - 1 = Enabled

**Note:** When the GPS mode is enabled, the SLAVE modem's serial's Baud Rate is changed to 4800 to receive data from GP-320B. To go back to normal serial operation mode, disable the GPS Mode.

- **DTM? – Retrieve GPDTM data sentence**
- **GGA? – Retrieve GPGGA data sentence**
- **ZDA? – Retrieve GPZDA data sentence**
- **GLL? – Retrieve GPGLL data sentence**
- **VTG? – Retrieve GPVTG data sentence**
- **RMC? – Retrieve GPRMC data sentence**

**Example capture of the remote commands:**

<0021/GPS?	<b>Queries current GPS status</b>
>0021/GPS=0[cr][lf]	<b>SLAVE responds that GPS is disabled</b>
<0021/GPS=1	<b>SLAVE is commanded to enable GPS</b>
>0021/GPS=[cr][lf]	<b>SLAVE confirms that GPS is enabled</b>
<0021/DTM?	<b>SLAVE is commanded to return GPDTM data sentence</b>
>0021/DTM=\$GPDTM,W84,,00.0000,N,00.0000,W,,W84*53[cr][lf]	
<0021/GGA?	
>0021/GGA=\$GPGGA,222830,3325.4268,N,11158.2640,W,0,01,00.00,000293.6,M,-026.2,M,,*7F[cr][lf]	
<0021/ZDA?	
>0021/ZDA=\$GPZDA,223145,14,10,2005,+00,00*63[cr][lf]	
<0021/GLL?	
>0021/GLL=\$GPGLL,3325.4268,N,11158.2640,W,222830,V,N*47[cr][lf]	
<0021/VTG?	
>0021/VTG=\$GPVTG,,T,,M,,N,,K,N*2C[cr][lf]	
<0021/RMC?	
>0021/RMC=\$GPRMC,222830,V,3325.4268,N,11158.2640,W,,,141005,011.8,E,N*12[cr][lf]	
<0021/GPS=0	<b>SLAVE is commanded to disable GPS</b>
>0021/GPS=[cr][lf]	<b>SLAVE confirms that GPS is disabled</b>
<0021/RMC?	<b>SLAVE is commanded to return GPRMC data sentence</b>
>0021/RMC*[cr][lf]	<b>SLAVE responds that data is not available</b>

# Appendix L. ADVANCED QUALITY OF SERVICE (QoS) OPTION

---

## L.1 Overview

Advanced Quality of Service (QoS) enables a network to use WAN bandwidth more efficiently by managing delay, jitter (delay variation), throughput, and packet loss. It is based on OSI model to Layer 7 protocol header parameters.

Advanced QoS requires that you install the optional IP Packet Processor, and that you purchase and activate the Advanced QoS FAST Option. Contact Comtech EF Data Product Support for further information.

QoS scheduling operates on modem Tx bandwidth with 1-byte resolution, so there is no further trimming or clipping data rate after the QoS scheduler.

QoS is implemented with at least one 1-second burst at maximum data rate.

QoS systems use a strict priority QoS scheduling algorithm. Excluding the default queue, the QoS system has up to 32 QoS queues with eight configurable priorities rules. The QoS system creates a separate queue for each rule to store the incoming stream of packets. (In this appendix, 'QoS rules' and 'QoS queues' are interchangeable).

QoS systems incorporates Weighted Random Early Detection (WRED) based congestion avoidance algorithm in addition to tail drop.

The CDM-570A/L-IP incorporates four Per Hop Behavior (PHP) QoS modes of operation:

- Mode 1 – Max/Pri (QoS Rules based on Maximum Bandwidth and Priority)
- Mode 2 – Min/Max (QoS Rules based on Minimum and Maximum Bandwidth)
- Mode 3 – DiffServ (Differentiated Services)
- Mode 4 – VLAN – Priority/Max (VLAN 802.1q)

## L.1.1 Max/Pri (Maximum Bandwidth/Priority) QoS Mode

In Max/Pri mode, up to 32 QoS rules can be configurable using source IP subnet, destination IP subnet, source port range, destination port range, and protocol. For each created rule, you can also set the QoS treatments such as priority, limiting the maximum bandwidth, WRED enable or disable, and filter enable or disable.

**Priority** – The IP Packet Processor classifies each packet that is to be forwarded over the satellite; the packet is then assigned a Priority Number (Priority level from 1 to 8) according to the defined QoS Rules:

- The lower the Priority Number, the higher that priority is (i.e., Priority 1 = highest priority; Priority 9 = lowest priority).
- Any latency critical traffic such as VoIP/RTP should always be assigned Priority 1.
- Priority 1 packets are forwarded immediately; Priority 2 packets are forwarded as soon as there are no Priority 1 packets in the Queue; and so on through Priority 8.
- Any packet that does not meet a QoS Rule is assigned to the Default Rule with Priority = 9.

**Maximum Bandwidth** – This can also be assigned to a flow to restrict the Maximum Bandwidth that any particular flow will utilize; otherwise, the default of no bandwidth restriction can be selected.

**Filtering** – QoS allows specific flows to be designated as “filtered” – this instructs the IP Packet Processor to discard traffic that is otherwise not wanted for forwarding over a satellite link.

When you enable the FILTER option for a rule, QoS provides the ability to filter the packet completely.

**QoS Rule Hierarchy** – It is quite possible to have traffic that meets the definitions of several QoS Rules. All traffic will be classified into the first QoS Rule that is a match, or fall into the Default Rule. The most specific QoS Rule will always be first. For example, a QoS Rule that identified a Source and Destination IP Address would be assigned ahead of a rule that just defined RTP protocol.

QoS Rules having the same amount of defined variables are sorted as follows:

1. Having a Protocol defined:

Protocol Priority		Protocol Priority	
CTRX	CITRIX Protocol	SAP	Service Announcement Protocol
FTP	File Transfer Protocol	SMTP	Simple Mail Transfer Protocol
HTTP	Hypertext Transfer Protocol	SNMP	Simple Network Management Protocol
ICMP	Internet Control Message Protocol	SQL	Structured Query Language Protocol
IP	All Internet Protocol	TCP	Transmission Control Protocol
N-IP	All Non-Internet Protocol	TELNET	Telnet Protocol
ORCL	ORACLE Protocol	UDP	User Datagram Protocol
RTP	All Real Time Protocol	VDEO	Video Real Time Protocol
RTSP	Real Time Protocol Signaling	+	Voice Real Time Protocol

2. Source IP Address or subnet defined.
3. Destination IP Address or subnet defined.
4. Source Port defined (lowest Port number first).
5. Destination Port defined (lowest Port number first).

The IP Packet Processor will sort each QoS rule as they are added and the QoS Configuration display will be updated to reflect the order with which rules are matched.

**QoS Statistics** – Every defined QoS Rule can be monitored to see the traffic flow for each queue. These statistics display the traffic sent in each queue, the amount of dropped traffic, and the number of Active Flows.

**Protocol and Port Number Considerations** – When defining QoS Rules, it is important to be aware of specifics of the traffic for which the rule is intended. When selecting a protocol for a QoS Rule, be aware that the IP Packet Processor allows for a very broad selection (such as IP) or a very specific protocol. For example, RTP traffic can consist of UDP portion (for voice or video) and a TCP portion (for RTP signaling). These could have separate QoS Rules created or all be included in a single Rule by selecting RTP as the protocol.

This diagram shows where each protocol selection resides:

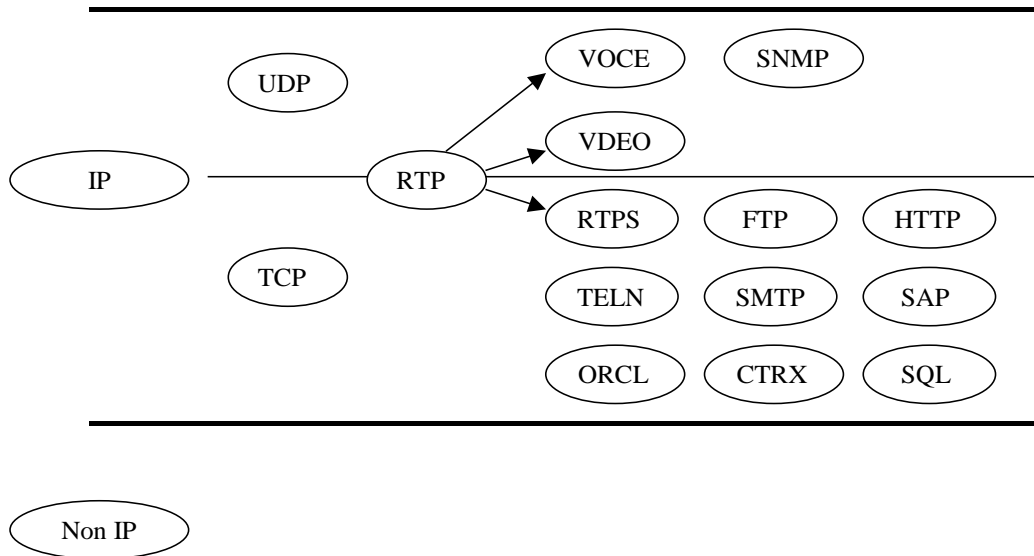

Selection of Source/Destination Ports should be done only if you are aware of the port usage of the desired protocol or application. There are well known ports for various protocols, but often only the 'command' messaging is transacted on these ports and the 'data' is transferred through a negotiated port.

Use this table as a reference for some well-known port numbers:

Port	Description	Port	Description
1	TCP Port Service Multiplexer (TCPMUX)	118	SQL Services
7	ECHO	119	Newsgroup (NNTP)
20	FTP - Data	137	NetBIOS Name Service
21	FTP - Control	139	NetBIOS Datagram Service
22	SSH Remote Login Protocol	150	NetBIOS Session Service
23	Telnet	156	SQL Server
25	Simple Mail Transfer Protocol (SMTP)	161	SNMP
42	Host Name Server (Nameserv)	179	Border Gateway Protocol (BGP)
53	Domain Name System (DNS)	190	Gateway Access Control Protocol (GACP)
69	Trivial File Transfer Protocol (TFTP)	197	Directory Location Service (DLS)
70	Gopher Services	396	Novell Netware over IP
80	HTTP	443	HTTPS
108	SNA Gateway Access Server	444	Simple Network Paging Protocol (SNPP)
109	POP2	546	DHCP Client
110	POP3	547	DHCP Server
115	Simple File Transfer Protocol (SFTP)	1080	Socks



**Once the QoS Rules are defined, each type of traffic flow should be isolated and sent to verify that it is being sent in the intended QoS Rule.**

**WRED** – When WRED is enabled for a specific queue, QoS randomly drops packets after reaching 50% of the QoS queue.

### L.1.1.1 Max/Pri QoS Mode Example

Do these steps:

1. Select **Max/Pri** QoS mode.
2. Set Modem Tx bandwidth to 2048 Kbps (E1 rate).
3. Configure the Max/Pri QoS rules as follows:

Index	Protocol	Src IP/ mask	Dest IP/ mask	Min Src Port	Max Src Port	Min Dst Port	Max Dst Port	Max BW	Priority	Filter	WRED
1	UDP	*/*	*/*	0	65535	0	65535	644	1	N	N
2	TCP	*/*	*/*	0	65535	0	65535	99999	2	N	N
3	HTTP	*/*	*/*	0	65535	0	65535	99999	3	N	N
4	Def	*/*	*/*	0	65535	0	65535	99999	9	N	N

The input data streams are as follows.

Stream	Protocol	Src IP	Dest IP	Src Port	Dest Port	Stream Data Rate
1	UDP	*/*	*/*	***	***	1024
2	TCP	*/*	*/*	***	***	1024
3	HTTP	*/*	*/*	***	***	1024
4	IP	*/*	*/*	***	***	64

**QUESTION:** What are the total output data rates and the individual stream data rates?

**ANSWER:** The individual stream data rates are as follows.

QoS Rule	QoS Priority	Input Data Rate	QoS Output Data Rate	Remain Data Rate (After Serving the Priority Queue)
1	1	1024 Kbps	644 Kbps due to max clipping	1404 Kbps
2	2	1024 Kbps	1024 Kbps	304 Kbps
3	3	1024 Kbps	380Kbps	0 Kbps
4	9	64 Kbps	0	0 Kbps
<b>Total</b>	<b>N/A</b>	<b>3136 Kbps</b>	<b>2048 Kbps</b>	<b>0 Kbps</b>

### L.1.2 Min/Max (Minimum/Maximum Bandwidth) QoS Mode

In Min/Max mode, up to 32 QoS rules can be configured using source/destination IP subnet, Layer 3 source/destination port range, and protocol (FTP, UDP, RTP, etc.). For each created rule, you can also set the QoS treatment, such as guaranteed minimum bandwidth, maximum clipping bandwidth, WRED enable or disable, and filter rule.

**Minimum Bandwidth** – Minimum specification that allows a committed information rate (CIR) to be applied to user-defined classes of traffic; otherwise, the default of no minimum bandwidth can be selected.

**Maximum Bandwidth** – This can be assigned to a flow to restrict the Maximum Bandwidth that any particular flow will utilize; otherwise, the default of no bandwidth restriction can be selected.

**WRED** – The Min/Max QoS mode allows selection of Weighted Random Early Detection (WRED).

When WRED is enabled for a specific queue, QoS randomly drops packets after reaching 50% of the QoS queue.

**Filtering** – Any specific flow can be designated as filtered (see Max/Pri QoS Mode).

When the FILTER option is enabled for a rule, QoS provides the ability to filter the packet completely.

**QoS Rule Hierarchy** – The QoS Rule Hierarchy is the same as Maximum Bandwidth/Priority QoS.

**QoS Statistics** – QoS Statistics are displayed as Maximum Bandwidth/Priority QoS.

### L.1.2.1 Min/Max QoS Mode Example

Do these steps:

1. Select **Min/Max** QoS mode.
2. Set Modem Tx bandwidth to 20 Mbps.
3. Configure the Min/Max QoS rules as follows:

Index	Protocol	Src IP/ mask	Dest IP/ mask	Min Src Port	Max Src Port	Min Dst Port	Max Dst Port	Min BW	Max BW	Filter	WRED
1	UDP	*/*	*/*	0	65535	0	65535	2500	4000	N	N
2	TCP	*/*	*/*	0	65535	0	65535	2500	99999	N	N
3	HTTP	*/*	*/*	0	65535	0	65535	0	99999	N	N
4	Def	*/*	*/*	0	65535	0	65535	0	9999	N	N

The input data streams are as follows:

Stream	Protocol	Src IP	Dest IP	Src Port	Dest Port	Stream Data Rate
1	UDP	*/*	*/*	***	***	10000 Kbps
2	TCP	*/*	*/*	***	***	5000 Kbps
3	HTTP	*/*	*/*	***	***	7000 Kbps
4	def	*/*	*/*	***	***	10000 Kbps



**QUESTION:** What are the total output data rates and the individual stream data rates?

**ANSWER:**

- In Min-Max QoS mode, other than the default rule, which is configured as Priority 9, all QoS rules are configured as Priority 8.
- In this mode, the minimum bandwidth for all rules – the excluding the default rule – will be served *first in round robin fashion*. In this example, the total minimum BW for Rules 1 and 2 is 5000 Kbps. Since the total bandwidth is 20 Mbps, it has enough bandwidth to serve.
- After serving the minimum bandwidth, the leftover bandwidth is 15 Mbps (20,000 Kbps–5000 Kbps).
- Leftover bandwidth will be served among all rules in round robin fashion until it hits maximum bandwidth limitations.
- Each rule's bandwidth is  $15/3 = 5000$  Kbps.
- Since Rule 1 maximum clipping was set to 4000 Kbps, and minimum bandwidth has already taken 2500 bytes, it will use 1500 Kbps more before reaching the maximum clipping. The leftover 3500 Kbps (5000-1500=3500) is again given to the main pool.
- Rule 2 does not have enough traffic coming in, so it will use only 2500 kbps (5000-2500); the remaining bandwidth (5000-2500=2500) is again given to the main pool.
- Rule 3's input stream is 7000 bytes; it will take its share of the 5000 allocation. Still, it needs 7000-5000=2000).
- After serving the fair share, the total leftover bandwidth is 6000 kbps (3500+2500=6000).
- Since Rule 3 needs the bandwidth, the leftover bandwidth is applied to that rule.
- After serving Rule 3, the leftover bandwidth 4000 Kbps will be applied to the default queue.
- The default rule will see the data rate of 4000 Kbps.

The individual rule's data rates are as follows:

QoS Rule	QoS Priority	Input Data Rate	QoS Output Data Rate
1	1	1000 Kbps	4000 Kbps
2	2	5000 Kbps	5000 Kbps
3	3	7000 Kbps	7000 Kbps
4	9	10000 Kbps	4000 Kbps
<b>Total</b>	<b>NA</b>	<b>3136 Kbps</b>	<b>20000 Kbps</b>

### L.1.3 DiffServ QoS Mode

The IP Packet Processor QoS can be set to DiffServ Mode to make it fully compliant to the Differential Services QoS RFC standards. When the QoS mode is set to DiffServ, the system automatically configures the rules with DSCP code points, priority values, and WRED. You can only configure the service rate and drop precedence levels for Assured Forwarding (ASFD) classes.

**Class Selector DiffServ Code Points (DSCP)** – Some implementations of DiffServ will prioritize traffic by Class Selector assignment. This is defined in the DSCP within the IP header. The first three bits of the DSCP define the Class Selector Precedence (or Priority):

Class Selector	DSCP	IP Packet Processor Priority	Class Selector	DSCP	IP Packet Processor Priority
Precedence 1	001 000	7	Precedence 5	101 000	3
Precedence 2	010 000	6	Precedence 6	110 000	2
Precedence 3	011 000	5	Precedence 7	111 000	1
Precedence 4	100 000	4	Default	000 000	9

The IP Packet Processor will prioritize the traffic based upon the DSCP Class Selector Precedence.



**All traffic that does not have the DSCP Class Selector Precedence defined (000 000) will be placed in the Default Queue and have a Precedence of 9.**

**Expedited Forwarding and Assured Forwarding DSCP** – Another implementation of DiffServ uses all six bits of the DSCP to define Expedited and Assured Forwarding:

DiffServ Type	Class Selector	DSCP	IP Packet Processor Priority
Expedited Forwarding	Precedence 1	101 110	3
Assured Forwarding – Class 1	Precedence 8	001 xx0	7
Assured Forwarding – Class 2	Precedence 8	010 xx0	7
Assured Forwarding – Class 3	Precedence 8	011 xx0	7
Assured Forwarding – Class 4	Precedence 8	100 xx0	7

**Expedited Forwarding (EF) DSCP** – This defines premium service and is recommended for real time traffic applications such as VoIP and video conferencing.

**Assured Forwarding (AF) DSCP** – This defines four service levels and also uses the last three bits of the DSCP to define the Drop Precedence (Low, Medium, or High). The Drop Precedence determines which packets will most likely be dropped during periods of over congestion, similar to WRED. As a result, each of the four AF service levels also have three Drop Precedence levels for which the IP Packet Processor provides 12 separate queues.

**Minimum Bandwidth (AF only)** – Minimum specification that allows a committed information rate (CIR) to be applied to user-defined classes of traffic, or the default of no minimum bandwidth can be selected.

**Maximum Bandwidth (AF only)** – This can be assigned to a flow to restrict the maximum bandwidth that any particular flow will utilize, or the default of no bandwidth restriction can be selected.



1. **Minimum and maximum bandwidth is only configurable for each of the four Assured Forwarding classes.**
2. **Typically, DiffServ is implemented using exclusively Class Selector DSCP or exclusively Expedited and Assured Forwarding DSCP. The IP Packet Processor is fully DiffServ compliant and will work with either DiffServ implementation, or with a combination of both.**

**WRED** – The QoS system supports WRED-based congestion avoidance. WRED can be enable or disabled on any queue. When WRED is disabled, upon overdriving the queue the packets will be tail dropped.

### L.1.3.1 DiffServ QoS Mode Example

Do these steps:

1. Select **DiffServ** QoS mode.
2. Set the modem Tx bandwidth to 10 Mbps.

The input streams to the modem are as follows:

Stream	Priority	PHB / DSCP Code	Service Rate	Drop Precedence	Data Rate
Management	1	CS7 / b111000	NA	NA	200 Kbps
Networking Control	2	CS6 / b110000	NA	NA	800 Kbps
Voice	3	EXFD / b101110	NA	NA	1Mbps
Video	3	CS5 / b101000	NA	NA	4 Mbps
Data-1	4	CS4 / b100000	NA	NA	550 Kbps
Data-2	5	CS3 / b011000	NA	NA	1450 Kbps
Data-3	7	ASFD4 / b100010	100	low	1 Mbps
Data-4	7	ASFD3 / b011010	400	low	1 Mbps
Data-5	7	ASFD2 / b010010	500	low	1 Mbps
Data-6	7	ASFD1 / b001010	800	low	1 Mbps
Data-7	8	BE / bXXXXXX	NA	NA	2 Mbps

**QUESTION:** What is the total output data rate and what are the individual port output data rates?

**ANSWER:**

- The QoS system first drains Priority 1 traffic. Since the management data stream is only 200 Kbps, after serving Priority 1 traffic, QoS still has 9.8 Mbps (10.0-0.2=9.8).
- QoS next drains Priority 2's 800 Kbps traffic. After the end of the Priority 2 traffic, QoS still has 9 Mbps traffic available (9.8-0.8=9).
- Similarly, QoS walks through all priorities until it hits the ASFD classes:
  - The beginning of ASFD Classes QoS leftover bandwidth is 2 Mbps.
  - All ASFD classes have the same Priority of 7, with different service rates.
  - ASFD service rate is a Committed Information Rate (CIR), except serviced if bandwidth available after serving all high priority queues. In this case, 2 Mbps bandwidth is available, serving all service rates first. The total of all ASFD service rates are 1.6 Mbps, which is less than the 2 Mbps leftover bandwidth.
  - After serving the service rates, the leftover bandwidth is 400 Kbps. This 400 Kbps will be distributed to all ASFD classes equally in round robin fashion until either there is no more bandwidth, or the input streams have no data.

The resulting individual data rates are as follows:

Stream	Priority	PHB / DSCP Code	Service Rate	Drop Precedence	Data Rate
Management	1	CS7 / b111000	200 Kbps	9.8 Mbps	200 Kbps
Networking Control	2	CS6 / b110000	800 Kbps	9.0 Mbps	800 Kbps
Voice	3	EXFD / b101110	1 Mbps	8.0 Mbps	1Mbps
Video	3	CS5 / b101000	4 Mbps	4.0 Mbps	4 Mbps
Data-1	4	CS4 / b100000	550 Kbps	3450 Kbps	550 Kbps
Data-2	5	CS3 / b011000	1450	2000 Kbps	1450 Kbps
Data-3	7	ASFD4 / b100010	1 Mbps	NA	100 + 100 Kbps
Data-4	7	ASFD3 / b011010	1 Mbps	NA	400 + 100 Kbps
Data-5	7	ASFD2 / b010010	1 Mbps	NA	500 + 100 Kbps
Data-6	7	ASFD1 / b001010	1 Mbps	NA	800 + 100 Kbps
Data-7	8	BE / bXXXXXX	2 Mbps	NA	0 Kbps
<b>Total</b>	<b>N/A</b>	<b>N/A</b>	<b>14 Mbps</b>	<b>0 Kbps</b>	<b>10 Mbps</b>

## L.1.4 VLAN – Priority/Max (VLAN-based Layer 2) QoS Mode

When selecting VLAN-based Layer 2 QoS, the priority field is extracted from the 802.1q VLAN tag as shown in **Figure L-1**. The VLAN tag priority field is 3 bits, so the 802.1q protocol supports eight priorities, from 0 to 7. However, because Layer 2 QoS has only four priorities as mentioned previously, as shown in **Table L-1** these eight VLAN priorities are automatically mapped to four internal priorities.

Similar to the Port-based scheduler, VLAN-based QoS also observes strict priority-based scheduling. Should overdriving of VLAN priority traffic occur, the packet will be dropped and drop stats will be incremented against that port.

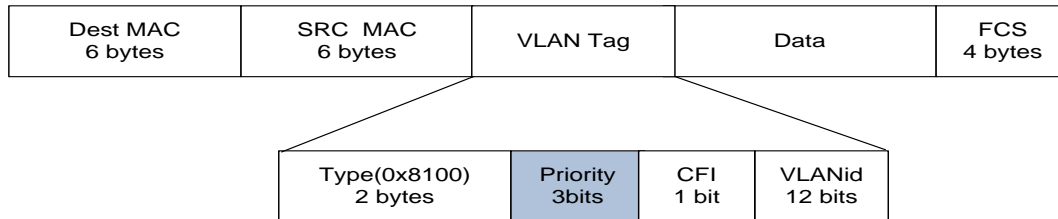

**Figure L-1. IEEE 802.1q VLAN Priority**

**Table L-1. 802.1q to Layer 2 QoS Priority Conversion**

802.1q VLAN Priority Field	Layer 2 QoS Priority
7 (b111)	Priority 1
6 (b110)	Priority 2
5 (b101)	Priority 3
4 (b100)	Priority 4
3 (b011)	Priority 5
2 (b010)	Priority 6
1 (b001)	Priority 7
0 (b000)	Priority 8

Even though it is not necessary to configure multiple ports with VLANs, the VLAN QoS will not look in the port information when classifying the packets into queue.



**In case VLAN Q-in-Q (double VLAN tag), the L2 VLAN QoS considers first VLAN tag priority field only for traffic prioritization.**

## L.2 QoS with ACM (Adaptive Coding and Modulation)

When ACM is enabled, the modem is configured with symbol rate. However, while the QoS system recognizes data rate, both Layer 2 QoS and Layer 3 QoS operate on data rate. Therefore, while the symbol rate will be constant in ACM mode, the data rate will *not* be constant. As a result, the modem's data rate can vary "on-the-fly" based on the EbNo. The data rate can be more or less than when QoS was first configured, or when the modems first boots.

### L.2.1 Maximum Clipping

Due to ACM, when in QoS Max-Pri mode and the data rate's available bandwidth exceeds the maximum clipping rate, the QoS system limits the output rate of that rule to configured maximum clipping rate.

When the available data rate is less than the maximum clipping rate, the QoS system has nothing to clip, since it has not exceeded the defined maximum bandwidth rate.

### L.2.2 Minimum Data Rate

Due to ACM, when the data rate's available bandwidth exceeds the minimum data rate (per QoS Min-Max and DiffServ modes' ASFD classes), the QoS system operates as normal; since the minimum has been met, the available bandwidth is shared among all other same priorities in round robin fashion.

When the available data rate is less than the minimum data rate, then the QoS system shares equally among all same priority queues in a round robin fashion until either minimum bandwidth is met, or no more data is available to drain.

### L.2.3 DiffServ w/ACM QoS Example

Do these steps:

1. Select **DiffServ** Layer 3 QoS mode.
2. Enable **ACM**.
3. The data rate of the modem drops down from 10 Mbps to 8.7 Mbps due to EbNo.

Input data streams are as follows:

Stream	Protocol	Src IP	Dest IP	Src Port	Dest Port	Stream Data Rate
1	UDP	***/*	***/*	***	***	10000 Kbps
2	TCP	***/*	***/*	***	***	5000 Kbps
3	HTTP	***/*	***/*	***	***	7000 Kbps
4	def	***/*	***/*	***	***	10000 Kbps

**QUESTION:** What will be the total data rate and what will be the individual data rates?

**ANSWER:**

- After serving all high priority queues, only 500 Kbps is left for ASFD classes.
- This leftover bandwidth is less than the total minimum bandwidth; it must therefore share the residual 500 Kbps among all four ASFD classes equally - i.e.,  $500/4=125$  Kbps per class.
- Since ASFD4 has the service rate 100 Kbps, the excess 75 Kbps will be given the other queues where the service rate not met.
- In this case the 75 Kbps again will share equally among ASFD3, ASFD2, and ASFD1 since these service rates were not met.

The resulting individual data rate is as follows:

Stream	Priority	PHB / DSCP Code	Input Data rate	Leftover BW (After Serving the Queue)	QoS output Data rate
Management	1	CS7 / b111000	200 Kbps	9.8 Mbps	200 Kbps
Networking Control	2	CS6 / b110000	800 Kbps	9.0 Mbps	800 Kbps
Voice	3	EXFD / b101110	1 Mbps	8.0 Mbps	1Mbps
Video	3	CS5 / b101000	4 Mbps	4.0 Mbps	4 Mbps
Data-1	4	CS4 / b100000	550 Kbps	3450 Kbps	550 Kbps
Data-2	5	CS3 / b011000	1450	2000 Kbps	1450 Kbps
Data-3	7	ASFD4 / b100010	1 Mbps	NA	100 Kbps
Data-4	7	ASFD3 / b011010	1 Mbps	NA	175 + 25 Kbps
Data-5	7	ASFD2 / b010010	1 Mbps	NA	175 + 25 Kbps
Data-6	7	ASFD1 / b001010	1 Mbps	NA	175 + 25 Kbps
Data-7	8	BE / bXXXXXX	2 Mbps	NA	0 Kbps
<b>TOTAL</b>	<b>N/A</b>	<b>N/A</b>	<b>14 Mbps</b>	<b>0 Kbps</b>	<b>8.7 Mbps</b>

### L.3 Glossary of Terms

**Filtering** – QoS allows specific flows to be designated as “filtered,” whereby the IP Packet Processor discards traffic that is otherwise not wanted for forwarding over a satellite link.

**Jitter** – Measured in milliseconds, this is the amount of variation between two consequent frames at the receiving end.

**Latency** – This is the amount of delay, measured in milliseconds, from Ethernet interface of the near -end modem to the Ethernet interface of the far-end modem.

**Maximum Bandwidth** – This value can be assigned to a flow to restrict the Maximum Bandwidth that any particular flow will utilize; otherwise, the default of no bandwidth restriction can be selected.

**Minimum Bandwidth** – This is also known as Committed Information Rate (CIR). It is the minimum guaranteed value allocated per that rule. Minimum bandwidth is given to the rule only if the total minimum bandwidth is greater than the total modem bandwidth, and ingress traffic on that rule is greater than the configured minimum bandwidth.

In cases where ingress traffic is less than the configured minimum bandwidth, then the unused bandwidth will be given to the other queues in that priority.

In cases where ingress traffic is more than the minimum bandwidth and the total bandwidth is less than the total modem data rate, then all the minimum data rates will be scaled down.

**QoS Segmentation and Reassembly (SAR)** – Packet Segmentation and Reassembly (SAR) is enabled automatically while QoS is enabled. However, SAR is an adaptive process; it will trigger only if the packet latency exceeds the threshold value (default to 25 msec). Latency value is calculated based on the satellite transmission bandwidth. There is no minimum segment size. However if the last segment is less than 16 bytes, then it will be appended to the previous segment excluding satellite HDLC header in order to avoid satellite overhead and consumption of CPU cycles.

**System Latency** – This is used to define the maximum duration that a packet will stay in a QoS queue. Rather than waste satellite bandwidth on invalid packets, this mechanism serves to ensure that old packets are “aged” out of the system.

**Weighted Random Early Detection (WRED)** – WRED allows for more graceful dropping of packets as QoS queues get full. Typically, without WRED, packets are dropped based upon a simple tail drop algorithm that is applied to packets as they are being added to the QoS queues. This can result in large numbers of contiguous packets being dropped, which causes many protocols such as RTP and TCP to ungracefully degrade performance in an over-consumed or bursty scenario. WRED applies a randomization, which means that the percentage change to drop packets increases as the queue becomes full, and minimizes the chances of global synchronization. Thus, WRED allows the transmission line to be used fully at all times.

The Max/Pri and Min/Max QoS modes allow enabling or disabling of the WRED option. In DiffServ mode, WRED is applicable to Assured forwarding only; however, the WRED option can be changed.

---

## L.4 QoS List of Supported RFCs (Requests for Comment)

RFC No.	Description
2474	“Definition of the Differentiated Services Field (DS Field) in the IPv4 and IPv6 Headers” Nichols, K., Blake, S., Baker, F. and D. Black, December 1998
2475	“An Architecture for Differentiated Services” Blake, S., Black, D., Carlson, M., Davies, E., Wang, Z. and Weiss, W., December 1998
2597	“Assured Forwarding PHB” Heinanen, J., Baker, F., Weiss, W. and J. Wrocklawski, June 1999
2598	“An Expedited Forwarding PHB” Jacobson, V., Nichols, K. and K. Poduri, June 1999



# Appendix M. TRANSMIT SPECTRUM FILTERING OPTIONS

---

## M.1 Overview

The CDM-570/570L Satellite Modem offered transmit filtering per Intelsat IESS-308.

The CDM-570A/570AL Satellite Modem now provides Transmit Alpha Filter Rolloff Factors (Tx alpha, or simply  $Tx\alpha$ ) of 0.05, 0.10, 0.15, 0.20, 0.25, or 0.35.



See “Section 1.4.1 Modulator” for detailed spectral density plots for all values of  $Tx\alpha$ .

---

## M.2 Observations and Recommendations

- In a perfectly linear channel with tightly controlled RF carrier frequencies, there is no penalty when using tighter rolloffs (smaller  $Tx\alpha$ ). The benefit of this is that more carriers can be fitted into a given amount of transponder bandwidth. You should, however, consider that in many cases, transponders are power limited, not bandwidth limited, leading to the conclusion that for power limited cases, tighter rolloffs do not provide an obvious benefit.

If, on the other hand, the assumptions of linearity and/or frequency stability are not true, then you should be aware of the potential degradations that can be caused by using lower values of  $Tx\alpha$ .

- As the rolloff decreases, the peak-to-average power ratio of the waveform increases, and if an SSPA (or any other element in the link) is approaching compression, the carrier will be more prone to spectral regrowth, and depending on the exact modulation type, this may cause additional degradation due to compression of outer constellation points (particularly with non-round constellations).

A White Paper that is to be published by Comtech EF Data will offer precise guidelines on the amount of additional output backoff (OBO) that is required for these new rolloffs. For now, Comtech EF Data recommends that, given a  $Tx\alpha$  of 0.20 or 0.15, you use an additional OBO of at least 0.5 dB; for a  $Tx\alpha$  of 0.10 or 0.05, use an additional OBO of at least 1.0 dB.

- The recommended minimum carrier spacing equals  $(1 + Tx\alpha) \times \text{symbol rate}$ , assuming equal symbol rates for all carriers and zero frequency error between carriers.

- At lower symbol rates, particular care needs to be taken with the frequency accuracy and stability of the RF carriers. **It is your responsibility to determine if sufficient guard band is built into the frequency plan to avoid carriers moving towards each other and overlapping at the edges.**



Now that you can choose between six different values of  $Tx\alpha$ , it now becomes important to match the Rx Alpha ( $Rx\alpha$ ) accordingly. Comtech EF Data has analyzed the effect of mismatching  $Tx\alpha$  and  $Rx\alpha$ , and has concluded that there is little benefit in providing six values of  $Rx\alpha$ . It has been determined that just two values of  $Rx\alpha$  – 0.35 and 0.12 – are required to match all six Tx cases.

In order to correctly set  $Rx\alpha$  – this assumes that you have knowledge of the  $Tx\alpha$  being transmitted – follow these guidelines:

- For a  $Tx\alpha$  of 0.05, 0.10, 0.15, or 0.20, use  $Rx\alpha = 0.12$ .
- For a  $Tx\alpha$  of 0.25 or 0.35, use  $Rx\alpha = 0.35$ .

If these rules are followed, then the amount of degradation due to mismatch will be  $< 0.05$  dB.

If these rules are **not** followed, then the amount of degradation due to mismatch can be  $> 0.3$  dB.



In Chapter 6. FRONT PANEL OPERATION, see:

- Sect. 6.3.2.3.11 (Config: Tx)  $\alpha$  (Tx Alpha Filter Rolloff Factor)
- Sect. 6.3.2.4.11 (Config: Rx)  $\alpha$  (Rx Alpha Filter Rolloff Factor)

# Appendix N. 1:1 IP REDUNDANCY

## N.1 Overview



**CAUTION** – This equipment contains parts and assemblies sensitive to damage by Electrostatic Discharge (ESD). Use ESD precautionary procedures when touching, removing, or inserting Printed Circuit Boards (PCBs).



- Chapter 9. OPTIONAL PACKET PROCESSOR – SERIAL/TELNET CLI OPERATION
- Appendix D. OPTIONAL HIGH-PERFORMANCE PACKET PROCESSOR



The CDM-570AL and CDMR-570AL L-Band Satellite Modems may be referred to throughout this appendix, collectively, as the **CDM/R-570AL**.

This appendix also identifies the CDM-570A, CDM-570AL, or CDMR-570AL Satellite Modems, as equipped with the optional High-Performance Packet Processor, collectively as the **CDM-570A/570AL-IP**.

The CDM-570A/570AL-IP and other compatible, IP-centric Comtech EF Data modems may also be generically referred to throughout this appendix as the **CDM-IP**.

The CDM-570A/570AL-IP can be configured for 1:1 IP Redundancy as a standard feature when used with a Comtech EF Data CRS-180 (70/140 MHz IF) or CRS-170A (L-Band) 1:1 Redundancy Switch:

Modem Type	CRS Switch Model
CDM-570A-IP (70-140 MHz IF)	CRS-180
CDM/R-570AL-IP (L-Band)	CRS-170A

This appendix describes CDM-570A/570AL-IP 1:1 IP Redundancy configuration and operation using either of these switches.

## N.2 Serial/Telnet CLI Operation Quick Reference



### Chapter 9. OPTIONAL PACKET PROCESSOR – SERIAL/TELNET CLI OPERATION

You must use the Serial/Telnet Command Line Interface (CLI) to execute most of the procedures specified in this chapter. These configuration steps are required to set up a CDM-570A-IP 1:1 Redundant IP System, using either a CRS-180 70/140 MHz (for the CDM-570A) or CRS-170A L-Band (for the CDM/R-570AL) 1:1 Redundancy Switch:

The Serial/Telnet CLI operates under a hierarchy of Configuration and Information functions. You may access any nested configuration or information page (e.g., Administration, Route Table, etc.) from this top-level menu by typing an available “Hot Key”, commonly provided at the right side of the screen.

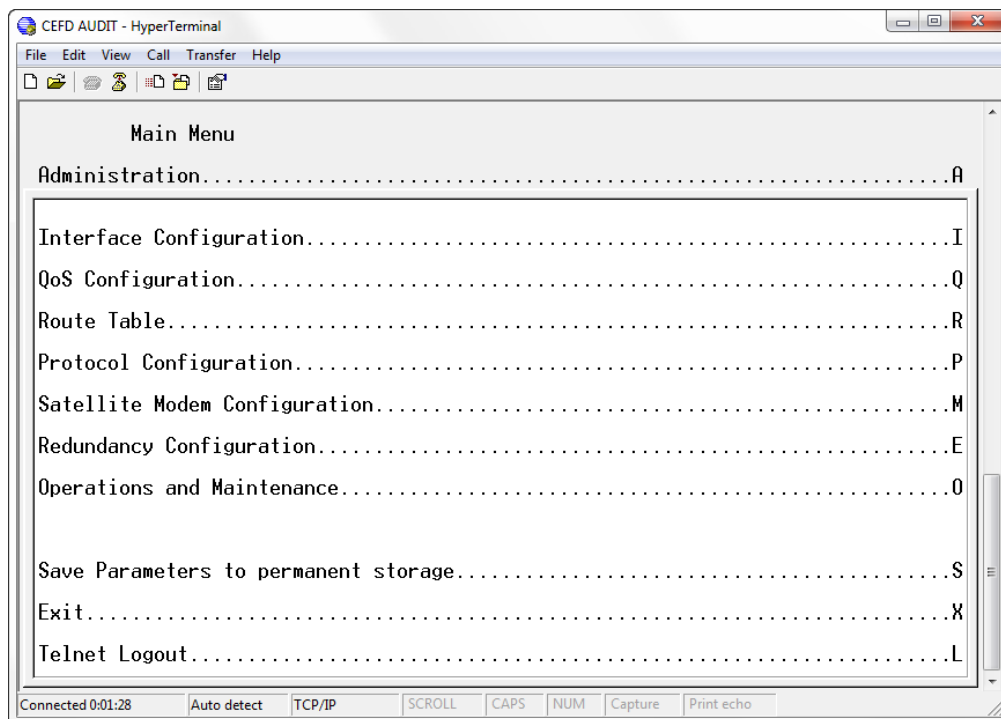

**Figure N-1. Serial/Telnet CLI Main Menu**

- **Common Interface Options/Fields** – The bottom of each primary and nested page provides three menu functions that are typical throughout the CLI:

Selection	Hot Key	Description
Save Parameters to permanent storage	S	Saves the current configuration of the Packet Processor to permanent storage. This configuration is restored on each successive power cycle.
Exit	X	Exits the current menu and returns to the parent menu. You may alternately press the Esc key to perform the same action.
Telnet Logout	L	Exits the CLI and closes the terminal emulator application.

M&C is accomplished as follows:

- **Selection** – This is the function or command as it appears on the menu page.
- **Hot Key** – This is the letter or number assigned as the keystroke/mnemonic for execution of a menu function or command.  
Where this column specifies **[RO]**, this means that this line item is a **read-only** (informational) feature. No user input is available.
- **Description** – This is the detailed explanation of the function or command. You are instructed to take a specific action here:
  - When you are instructed to “set” a feature, this means that you are prompted to type the numerical value for that feature. Press [Enter] to execute configuration. User guidance to “set” a value within a permitted range (from a minimum value to a maximum value) is commonly provided in parentheses or brackets.
  - When you are instructed to “select” a feature, this means that a numbered list of choices is commonly provided. Type the number to execute your operational selection. Press [Enter] to execute configuration.
  - When you are instructed to “toggle” a feature, this generally means that pressing the Hot Key executes one of two operating states for that feature (e.g., Enabled or Disabled, On or Off, Auto or Manual, etc.). The feature line will dynamically update to display, in brackets, its updated and current operating state.

---

## N.3 CRS-XXX 1:1 Redundancy Switch Functional Description

### N.3.1 CRS-180 70/140 MHz 1:1 Redundancy Switch



See the **CRS-180 70/140 MHz 1:1 Redundancy Switch Installation and Operation Manual (CEFD P/N MN/CRS180.IOM)** for detailed information on CRS-180 operation.

The CRS-180 70/140 MHz 1:1 Redundancy Switch performs the transmit and receive coaxial switching required for redundant modem operation. It switches both the Tx and Rx coaxial cables simultaneously.

Select **Unit Faults** only, **Unit Faults or Receive Traffic Faults**, or **Unit Faults or Transmit Traffic Faults**, or all three for the switchover criteria with the two switches on top of the unit. This selection provides a great deal of flexibility in the operation of the switch. Green LEDs on the antenna side of the CRS-180 indicate which modem is online.

The control cable from each modem to the CRS-180 also includes +12V power to operate the CRS-180. Power from both modems is diode OR'ed so that the switch remains active if power is lost from one of the modems.

The CRS-180 provides IF redundancy. On the Tx side, it switches the Tx IF signal. The Rx IF signal from the RF equipment is split in a power divider to continuously drive both the online and offline demodulator. The offline demodulator can then maintain lock so that it is ready to quickly assume online status for receive traffic when a switchover is required.

### N.3.2 CRS-170A L-Band 1:1 Redundancy Switch



See the **CRS-170A L-Band 1:1 Redundancy Switch Installation and Operation Manual (CEFD P/N MN/CRS170A.IOM)** for detailed information on CRS-170A operation.

The CRS-170A L-Band 1:1 Redundancy Switch performs the Tx and Rx coaxial switching required for redundant modem operation with an outdoor BUC and LNB. It switches all of the BUC and LNB interface signals that are multiplexed onto the Tx and Rx coaxial cables:

- Tx and Rx L-Band signals
- 10 MHz reference to BUC and LNB
- DC Power to BUC and LNB
- FSK signaling to the BUC

Select **Unit Faults** only, **Unit Faults or Receive Traffic Faults**, or **Unit Faults or Transmit Traffic Faults**, or all three for the switchover criteria. This selection provides a great deal of flexibility in the operation of the switch. Green LEDs on the antenna side of the CRS-170A indicate which modem is online.

The control cable from each CDM/R-570AL-IP modem to the CRS-170A also includes +12V power to operate the CRS-170A. Power from both modems is diode OR'd so that the switch remains active if power is lost from one of the modems.

The CRS-170A provides L-Band redundancy, but when switching occurs, it accommodates more than just the L-Band signals. On the Tx side, it switches the Tx L-Band signal, the 10 MHz reference to the BUC, DC power to the BUC, and FSK signaling to the BUC. On the Rx side, it switches the 10 MHz reference to the LNB, and DC power to the LNB. The Rx L-Band signal from the LNB is split in a power divider to continuously drive both the online and offline demodulator. The offline demodulator can then maintain lock so that it is ready to quickly assume online status for receive traffic when a switchover is required.

## N.4 CDM-570A/570AL-IP 1:1 IP Data Switching Functional Description

When the CDM-570A/570AL-IP modem is using a serial data interface (for example, RS.422 or V.35), the paired modems are connected to a CRS-180 (or CRS-170A) 1:1 Redundancy Switch with an adapter Y-cable. When the CDM-570A/570AL-IP is using the optional Packet Processor as the data interface, as shown in **Figure N-2**, you may use a standard Ethernet Layer 2 Switch or Hub (it is recommended that you use a Layer 2 Switch).

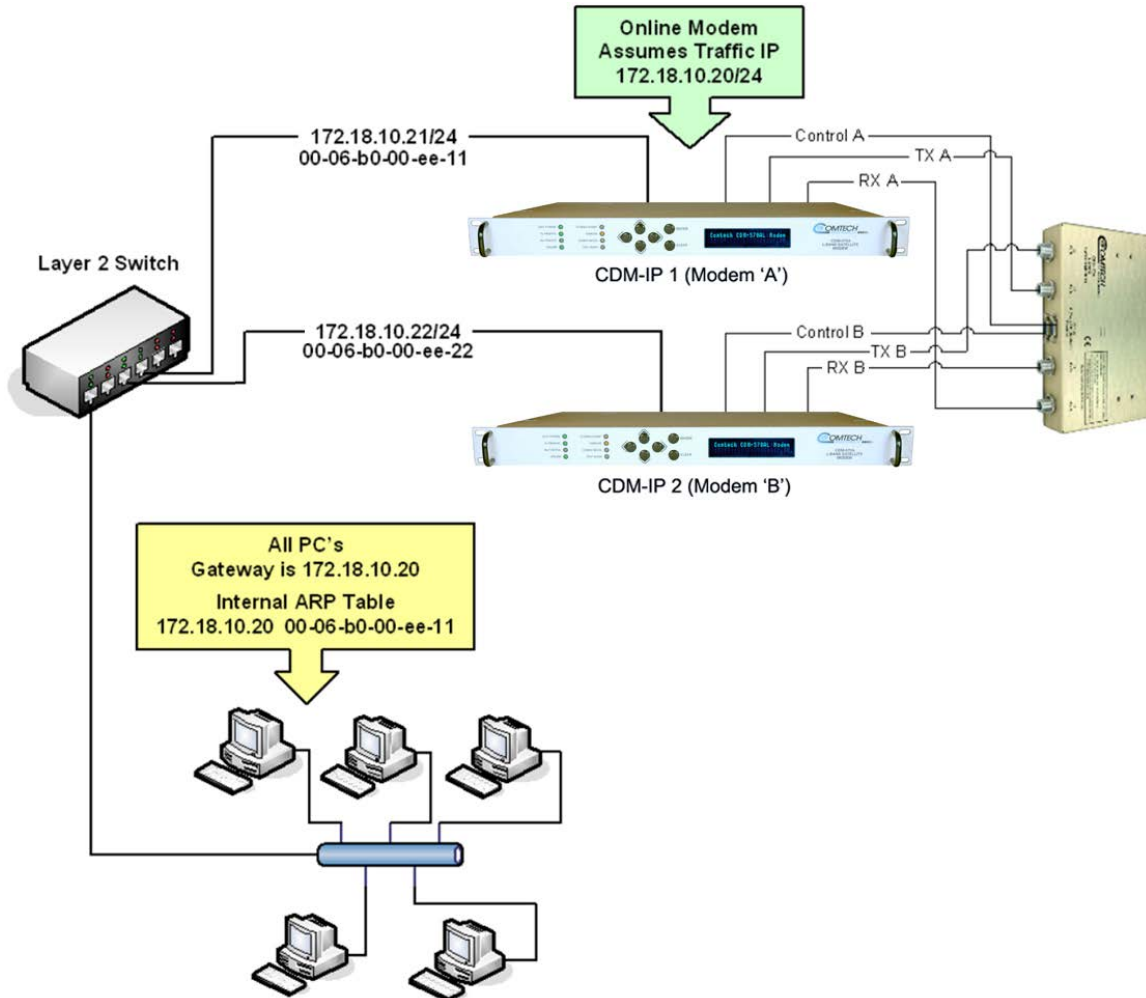

**Figure N-2. CDM-570A/570AL-IP 1:1 IP Redundancy Example (Router Mode Shown, Modem 'A' Online)**

For CDM-570A/570AL-IP IP 1:1 redundancy operation, both CDM-570A/570AL-IP s are assigned a unique M&C IP address on the same subnet (in **Figure N-2**, 172.18.10.21/24 and 172.18.10.22/24). A Traffic IP address on the subnet is also assigned (172.18.10.20/24).

Whichever modem is online also assumes the Traffic IP.

When there is a switchover to the backup modem, this modem now assumes the Traffic IP. It also broadcasts a "Gratuitous ARP" that tells all local devices to now associate a new MAC address for the Traffic IP 172.18.10.20. Each device updates their ARP tables, traffic virtually resumes instantaneously.



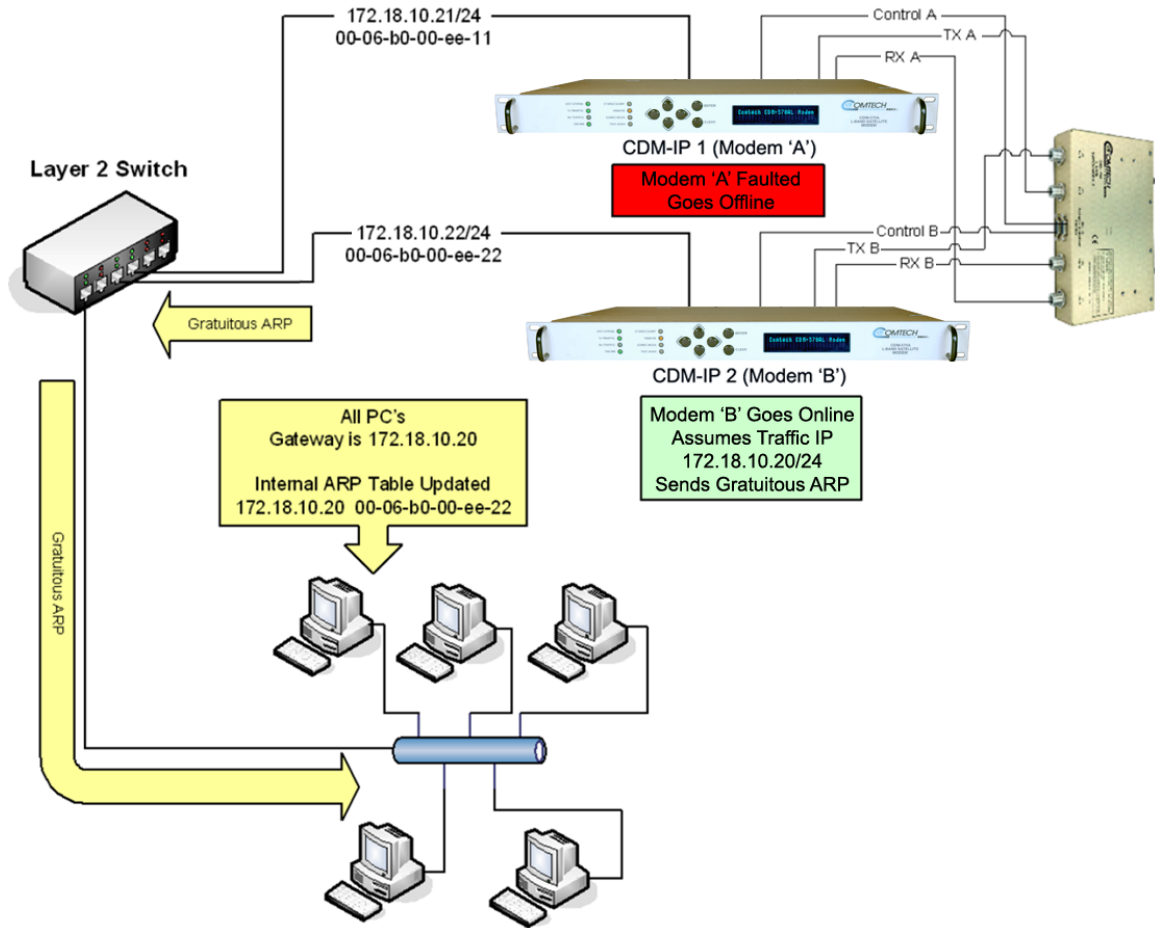

Figure N-3. CDM-570A/570AL-IP 1:1 IP Redundancy Switchover Example  
(Router Mode Shown, Modem 'B' Online)



All configuration changes can only be made to the Online CDM-570A/570AL-IP and will require a "Save Parameters to permanent storage" so that the configuration change is also applied to the Backup CDM-570A/570AL.

---

## N.5 CDM-570A/570AL-IP 1:1 IP Redundancy Configuration

Do these steps:

1. First, you need to establish an Ethernet connection between the CDM-570A/570AL-IP pair. You can do this by using a standard Ethernet Layer 2 Switch or Hub (it is recommended that you use a Layer 2 Switch).
2. Before you can connect the CDM-570A/570AL-IP s to the CRS-XXX 1:1 switch, you must first use the CLI to configure the following CDM-570A/570AL-IP Packet Processor settings.

From the CLI Main Menu (the applicable “hot key” is shown in brackets [#]):

- You must *disable* 1:1 Redundancy on both modems:

**Administration [A] → Redundancy Configuration [E] → 1:1 Redundancy [R]**

Toggle 1:1 Redundancy State as **DISABLED**;

- You must set both modems to the same Working Mode;

**Administration [A] → Working Mode [C]**

- You must configure both modems with the same IP Option Features.

**Administration [A] → Feature Configuration [F]**

3. On both modems, enter a unique IP Address that is on the same subnet:

**Interface Configuration [I] → Ethernet Interface [E] → IP Address [I]**

Verify that you can ping from one CDM-570A/570AL-IP to the other:

**Operations and Maintenance [O] → Diagnostics [G] → Ping [P]**

4. *Enable* 1:1 Redundancy on both modems:

**Administration [A] → Redundancy Configuration [E] → 1:1 Redundancy [R]:**

Toggle 1:1 Redundancy State as **ENABLED**.

**Save Parameters to Permanent Storage [S]** and power down both modems.

5. Connect the CDM-570A/570AL-IP to the 1:1 switch:

- See **Sect. P.4** for cabling the CDM-570A-IP to the CRS-180;
- See **Sect. P.5** for cabling the CDM/R-570AL-IP to the CRS-170A.

6. While monitoring the CLIs for both modems, observe the following after powering on both modems at the same time (also observe the switch Online LEDs to see which modem is the Online modem).

- Online modem CLI will display:

```
1:1 Redundancy (Auto Detected)

Redundancy: PARAM File Connection Established.

Redundancy: Sending PARAM File...
```

- Offline modem will display:

```
1:1 Redundancy (Auto Detected)

Redundancy: Received PARAM File...

Writing 5447 bytes to PARAM file on Flash
```

7. On the Online modem, select the Redundancy Configuration menu [R] from the CLI Main Menu. Observe that the correct IP Addresses/Masks are displayed for the Local and Redundant Units.

You must then set the Traffic IP Address/Mask (this also needs to be in the same subnet as the Management IP addresses):

```

1:1 Redundancy Configuration

1:1 Redundancy.....[Enabled].....R
1:1 Redundancy State.....[Online]
Traffic IP Address.....[192.168.1.50].....T
Traffic Subnet Prefix Length.....[ 24 ].....M
Management IP Address (Local Unit).....[192.168.1.17]
Management Subnet Prefix Length (Local Unit).....[ 24 ]
Management IP Address (Redundant Unit).....[192.168.1.52]
Management Subnet Prefix Length (Redundant Unit)..[ 24 ]
Force Unit Offline.....F
Redundancy Mode.....[Auto].....A

```



**All configuration changes can only be made to the Online CDM-570A/570AL-IP and require that you “Save Parameters to permanent storage [S]” so that the configuration change is also applied to the Backup CDM-570A/570AL.**

## N.6 Cabling the CDM-570A-IP

**Figure N-4** shows connections of a pair of CDM-570A-IP s to the CRS-180 70/140 MHz 1:1 Redundancy Switch. The table provided here lists cable assemblies that may be supplied with the CRS-180.

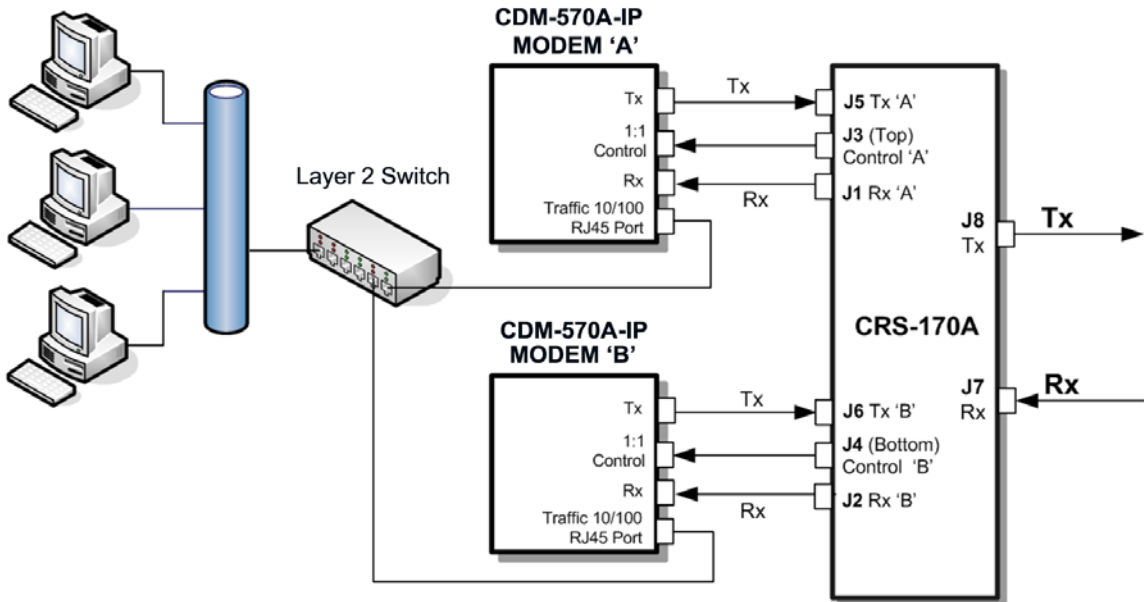

Quantity	Part #	Description
2	CAWR9378-4	Control Cable, Universal, DB9 Male to Male, 4'
4	PL/0946-1	IF (Tx/Rx) Coax Cable, 50Ω Type 'BNC', 4'

**Figure N-4. CDM-570A-IP and CRS-180 Interconnect**

It is essential that you correctly make the control and Rx/Tx IF cable connections. For example, the Tx IF from Modem 'A' connects to the Tx IF port 'A' on the CRS-180, and Modem 'B' connects to the Tx IF Port 'B' (and the same for the Rx IF connections). Failure to observe this cabling requirement will result in system malfunction.



**When connecting the control cables between the CRS-180 and the modems, make sure that the screw locks on the Type 'D' connectors are securely fastened. This prevents the accidental unmating of the cable, particularly if a standby unit must be removed or replaced.**

## N.7 Cabling the CDM/R-570AL-IP

Figure N-5 shows connection of a pair of CDM/R-570AL-IP s to the CRS-170A L-Band 1:1 Redundancy Switch. The table provided here lists cable assemblies that may be supplied with the CRS-170A.

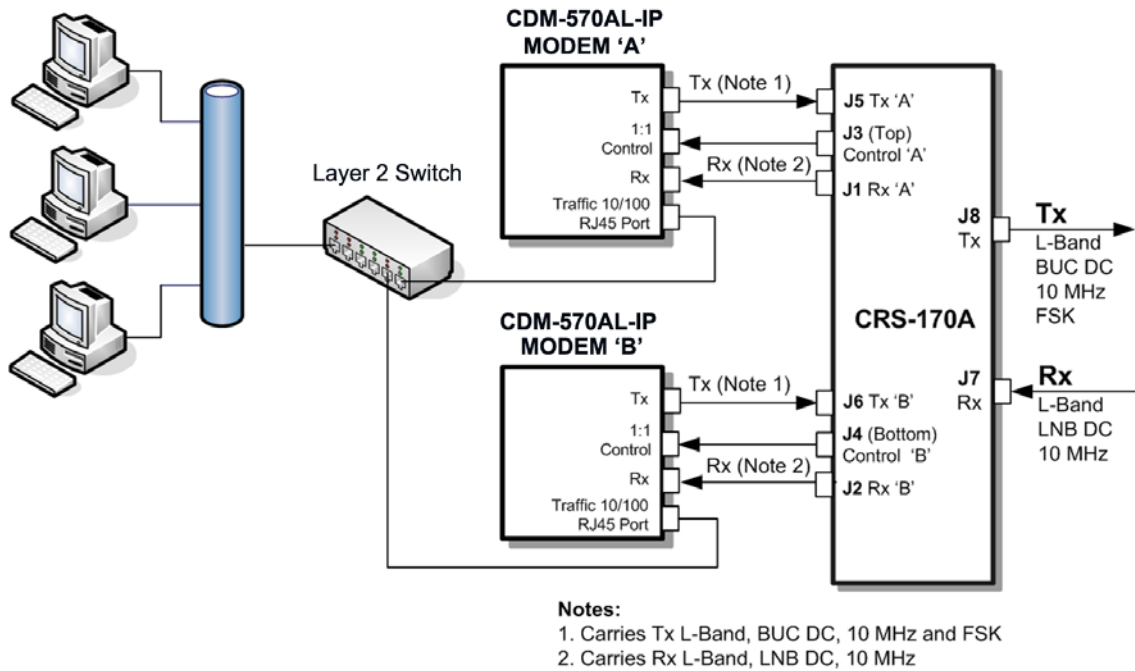

Quantity	Part #	Description
2	CA/WR9378-4	Control Cable, Universal, DB9 Male to Male, 4'
4	CA/RF10453-4	RoHS-Compliant Cable – IF (Tx/Rx), 50Ω Type 'N', 4'

**Figure N-5. CDM/R-570AL-IP and CRS-170A Interconnect**

It is essential that you correctly make the control and Rx/Tx IF cable connections. For example, the Tx IF from Modem 'A' connects to the Tx IF port 'A' on the CRS-170A, and Modem 'B' connects to the Tx IF Port 'B' (and the same for the Rx IF connections). Failure to observe this cabling requirement will result in system malfunction.



**When connecting the control cables between the CRS-170A and the modems, make sure that the screw locks on the Type 'D' connectors are securely fastened. This prevents the accidental unmating of the cable, particularly if a standby unit must be removed or replaced.**



# Appendix P. ADAPTIVE CODING AND MODULATION (ACM) OPTION

---

## P.1 Overview



**VersaFEC and VersaFEC-2 are technologies that are wholly owned and developed by Comtech EF Data and Comtech AHA Enterprise Products Group. VersaFEC is a registered trademark of Comtech AHA Enterprise Products Group.**

The VersaFEC Adaptive Coding and Modulation (ACM) is a significant feature in the CDM-570A/570AL. It may be used with either VersaFEC, or for modems running Firmware Version 1.5.2 or later, with a VersaFEC-2 plug-in Option Card.

The ACM serves as an operational enhancement for the CDM-570A/570AL-IP Satellite Modem (so named when the CDM-570A, CDM-570AL, or CDMR-570AL modem is equipped with the optional High-Performance Packet Processor):

- ACM turns fade margin into increased link capacity – gains of 100% or more are possible, compared to traditional Constant Coding and Modulation (CCM). This is accomplished by automatically adapting the modulation type and FEC code rate to give highest possible throughput.
- ACM maximizes throughput regardless of link conditions (noise or other impairments, clear sky, rain fade, etc). Initial setup is easy, and then requires no further user intervention.
- With CCM systems, severe rain fading can cause the total loss of the link, and zero throughput. ACM keeps the link up (with lower throughput) – and can yield much higher system availability.
- ACM in the CDM-570A/570AL-IP is used in conjunction with VersaFEC and is currently for *IP traffic only*.

The VersaFEC ACM feature requires activation of the appropriate FAST codes.



### Chapter 5. FAST ACTIVATION PROCEDURE

## P.2 Background

ACM is not a new concept. It has been used for some time in wireless communications, including terrestrial microwave applications and, more recently, over satellite links. Its primary function is to optimize throughput in a wireless data link, by adapting the modulation order used and the Forward Error Correction code rate – both of which directly affect spectral efficiency (expressed in bits per second per Hertz) according to the noise conditions (or other impairments) on the link. Implicit in this concept is that the symbol rate (and power) of the wireless communication system *must remain constant*. This ensures that the bandwidth allocated for a particular link is never exceeded.

Given that the symbol rate does not change, if modulation and coding are changed, the data rate must therefore be modified. This is expressed in the simple equation:

$$\text{Symbol rate} = \text{bit rate} / (\text{modulation order} * \text{code rate})$$

For example, for Rate 3/4 QPSK (where modulation order = 2):

$$\text{Symbol rate} = \text{bit rate} * 0.666$$

Re-arranging:  $\text{Bit rate} = \text{symbol rate} * \text{modulation order} * \text{code rate}$

So, in changing to a higher modulation order or code rate, the bit rate is **increased**, and in changing to a lower modulation order or code rate, the bit rate is **reduced**.

However, some important factors must be considered:

- **The digital communications system must be able to tolerate a change in bit rate.**

Synchronous serial interfaces (such as G.703 E1, which operated at a fixed data rate of 2.048 Mbps) are totally unsuitable in a scheme where data rate is changing. The only practical application for this scheme is a packet-based scheme that will tolerate a change in data rate, and which has mechanisms within its protocols to recognize when increased or reduced bandwidth is available. The best example of this is Ethernet, and this discussion is limited to schemes that employ it.

- **The bit rate cannot be changed arbitrarily.**

The link noise conditions, described in terms of Eb/No or SNR, must be able to support reliable communications for the given modulation order and code rate. This is a key point, as in fact, *the link SNR is the input that drives the adaptation*.



---

### P.3 Requirements for ACM

A generic example of ACM-over-Satellite is shown in **Figure P-1**. The essential requirements for enabling this scheme as follows:

- A modulator and FEC encoder that can instantaneously, when commanded, change either modulation type (order) or FEC encoder rate, or both. This needs to be accomplished without the corruption of data anywhere in the path. Block FEC codes are considered to be the most practical in achieving the required synchronization. Recently, a specific nomenclature has emerged to describe a combination of a modulation type and code rate – namely, **ModCod** (also referred to as **Mod/Code**). The modulator is required to send the value of ModCod at the start of each code block to signal the demodulator/decoder how to configure for the correct modulation type and FEC code rate.
- A receiver that is capable of demodulating and decoding the signal transmitted by a) without any *a priori* knowledge of when a change has taken place, but based purely on the value of ModCod seen at the start of each FEC block. Again, this needs to be accomplished without the corruption of data anywhere in the path.
- The receiver in b) needs to derive an estimate of the link quality (in terms of Eb/No, SNR, etc) and then communicate this estimate, via a return channel, to the modulator in a).
- The modulator in a) needs to be able to process the link quality metric from the demodulator in b), and then, based upon a pre-determined algorithm, adapt the data rate and change the ModCod sent to the receiver at the distant end. Thus, the data rate on the link can be maximized, given the current link noise conditions.

BLANK PAGE

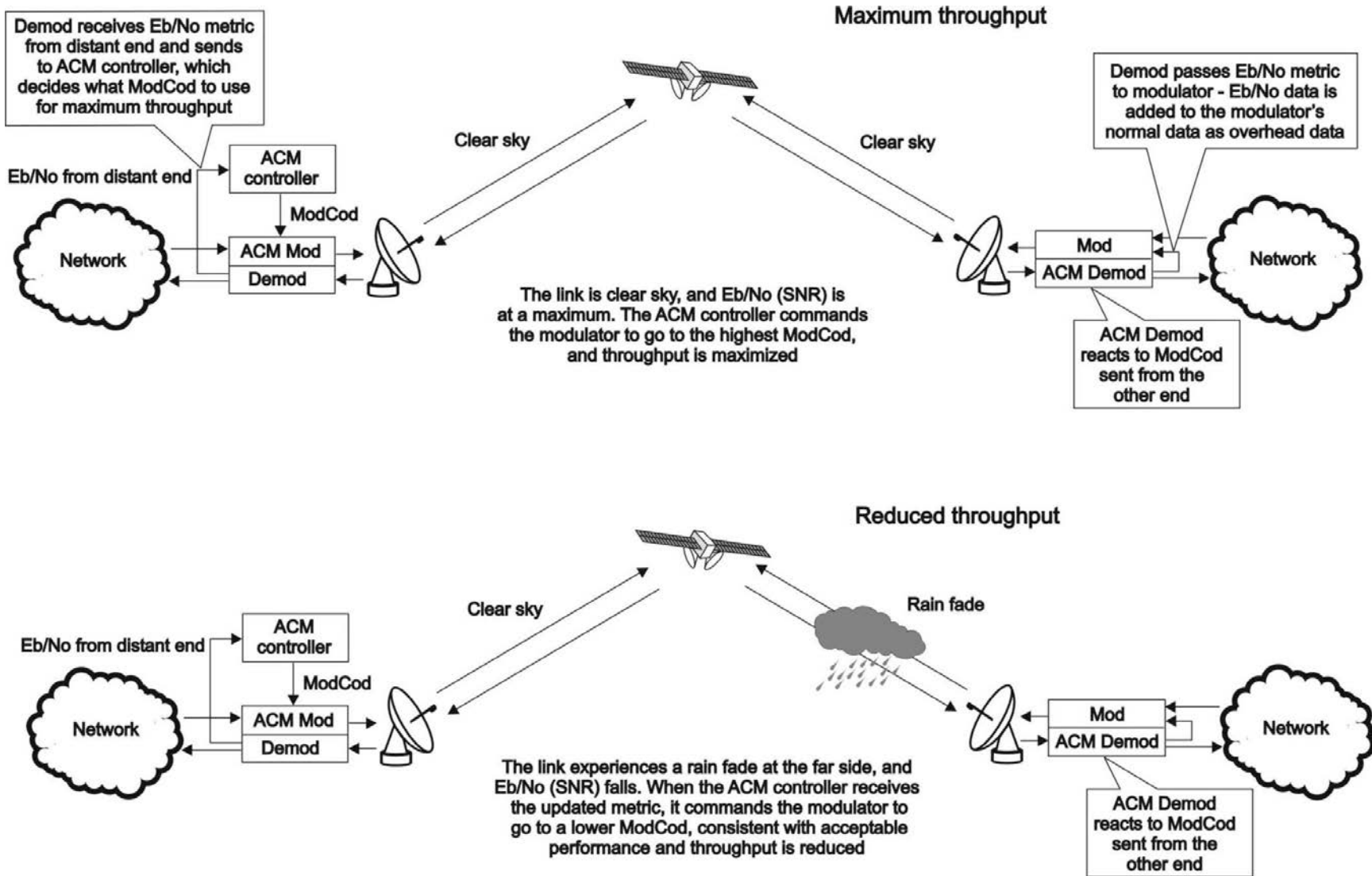

Figure P-1. ACM-over-Satellite – Generic Example

BLANK PAGE

---

## P.4 An Existing Satellite ACM Scheme

The best-known scheme for ACM-over-Satellite is covered in the DVB-S2 specification (EN 302307) ratified by ETSI in March 2005. While primarily for digital video broadcast, the DVB-S2 specification also encompasses two-way interactive services.

A summary of the main transmission aspects follows:

- Four modulation types are defined: QPSK, 8PSK, 16APSK and 32APSK.
- The primary FEC type is low-density parity check coding (LDPC), concatenated with a short BCH code.
- The 8PSK, 16APSK, and 32APSK modulation types use interleaving.
- There are ten code rates defined: 1/4, 1/3, 2/5, 1/2, 3/5, 2/3, 3/4, 4/5, 5/6, 8/9 and 9/10, which depend on the modulation type and other system requirements.
- A single FEC block may be 64800 bits (normal, referred to as 64k blocks) or 16200 bits (short, referred to as 16k blocks)
- Adaptive coding and modulation is defined for optimizing satellite transponder capacity.

Hughes Network Systems (Germantown, MD) have commercially deployed DVB-S2 with ACM over satellite.

---

## P.5 Disadvantages of DVB-S2

While the scheme defined by DVB-S2 is undoubtedly very effective for many broadcast and higher data rate applications, it is definitely not a 'one size fits all' solution. Some of the disadvantages are as follows:

- **Excessive latency.** The so-called short blocks are too long for low latency IP applications at low data rates. This is exacerbated by the addition of interleaving.
- **Overly complex in its implementation.** The design of DVB-S2 dictated that all FEC blocks should be constant in *bits*. This means that for each ModCod, there are a varying number of *symbols*. This then makes the task of synchronization a much more demanding task. Also, because of the limitations of tracking the higher-order modulations in a very low SNR environment, so-called pilot symbols were added in order to aid tracking.
- **Concatenated BCH code added to mitigate the problem of error rate 'flaring' and 'flooring'.** This is no longer necessary. Since the introduction of the original LDPC/BCH scheme, an enormous amount of research has been done on the design of LDPC codes. Most importantly, however, LDPC codes can now be designed that yield almost equivalent coding gain, but with considerably shorter block lengths.
- **In an ACM mode, no overhead channel was defined by DVB-S2 for the purpose of reporting SNR metrics to the originating end.** It has been left to individual equipment manufacturers to decide their own method. This illustrates that all ACM systems, DVB-S2 or not, are proprietary. In addition, it implies that additional bandwidth needs to be consumed for the SNR reporting, and this is not accounted for in the code rate.

## P.6 VersaFEC ACM (IP-ACM)



### Appendix B.6. FEC (FORWARD ERROR CORRECTION) OPTIONS

#### P.6.1 VersaFEC ACM Latency

In an ACM system that has a number of ModCods, each having a different latency, what defines the overall system latency? The answer is simple – the latency of the worst-case ModCod. (This may not seem obvious to some, and it is beyond the scope of this chapter to provide a rigorous defense of this statement. It *is*, however, a correct statement despite certain believers in non-causal systems and encoders that possess the magical quality of negative latency...)

Examining the data in **Table P-1**, latency for each ModCod is shown for the example of VersaFEC ACM at a fixed 100 ksymbols/second rate. Of particular note is that even though the ModCods span a 7:1 variation in throughput, the latency is only varying between 25 and 34 milliseconds. A careful analysis will show that this is a consequence of using a **constant number of symbols per block**. In the example shown the worst-case latency for this ACM scheme is 34 milliseconds, + WAN Buffer delay (which is configurable, with a minimum value of 20ms).

**Table P-1. VersaFEC Implementation of ACM – 100 ksymbols/sec Example Case**

ModCod	Modulation	Code Rate	Spectral efficiency, bps/Hz	Bit rate (throughput)	Minimum Latency, In milliseconds, for each ModCod
0	BPSK	0.488	0.49	49 kbps	34 + WAN BUFFER
1	QPSK	0.533	1.07	107 kbps	32 + WAN BUFFER
2	QPSK	0.631	1.26	126 kbps	30 + WAN BUFFER
3	QPSK	0.706	1.41	141 kbps	28 + WAN BUFFER
4	QPSK	0.803	1.61	161 kbps	26 + WAN BUFFER
5	8-QAM	0.642	1.93	193 kbps	30 + WAN BUFFER
6	8-QAM	0.711	2.13	213 kbps	28 + WAN BUFFER
7	8-QAM	0.780	2.34	234 kbps	27 + WAN BUFFER
8	16-QAM	0.731	2.93	293 kbps	27 + WAN BUFFER
9	16-QAM	0.780	3.12	312 kbps	26 + WAN BUFFER
10	16-QAM	0.829	3.32	332 kbps	25 + WAN BUFFER
11	16-QAM	0.853	3.41	341 kbps	25 + WAN BUFFER
OVERALL SYSTEM LATENCY = Worst-case ModCod (ModCod0) Latency = 34 milliseconds + WAN Buffer delay					

By way of comparison, consider the same 100 ksymbols/second rate, but this time using DVB-S2. It becomes clear that there is an unintended penalty (besides demodulator complexity) to having a **constant number of bits per block**. Each time the ModCod is lowered and the throughput is reduced, the latency grows accordingly due to the block size being related to data rate, not symbol rate.

Remembering that, for the ACM case, the system latency is equal to the latency of the worst-case ModCod, DVB-S2 shows a severe penalty. For 16k short blocks, this calculates to be 329 milliseconds (+ WAN Buffer delay) *versus* 34 milliseconds (+ WAN Buffer delay) for VersaFEC ACM. For 64k block DVB-S2, the core latency is 4 times higher. Assuming a WAN Buffer of 20 milliseconds:

- Latency for 64k block DVB-S2 ACM at 100 ksps = **1336 milliseconds**
- Latency for 16k block DVB-S2 ACM at 100 ksps = **349 milliseconds**
- Latency for VersaFEC ACM at 100 ksps = **54 milliseconds**



- **For the example shown, the latency for a 16k block DVB-S2 ACM scheme is approximately 7 times higher than VersaFEC ACM.**
- **The latency for a 64k block DVB-S2 ACM scheme is approximately 25 times higher than VersaFEC ACM.**

## P.6.2 Configuring VersaFEC ACM



### Chapter 6. FRONT PANEL OPERATION



**VersaFEC ACM requires the appropriate FAST code for the maximum operating symbol rate.**



**The ACM system is designed to switch based on thresholds that correspond to a BER of  $5 \times 10^{-8}$  for each ModCod. However, in order to prevent oscillation around two ModCods at this exact value, 0.3 dB of hysteresis has been added.**

Do these steps to configure the CDM-570A/570AL for VersaFEC ACM operation from the CDM-570A/570AL front panel:

Step	Task	Front Panel VFD Mnemonic
1	(SELECT) CONFIG: TI Use the ◀▶ arrow keys to select a parameter. Press ENTER to set the mode as IP-ACM.	Data Intf: RS422 IP V.35 RS232 G703 IP-ACM V2-ACM
2	(SELECT) CONFIG: TI → IP-ACM → ACM Use the ◀▶ arrow keys to select a parameter. Press ENTER to set the mode as <ul style="list-style-type: none"> <li>• ModCod</li> <li>• Unlock-Action</li> <li>• Target-SNR-Margin</li> </ul>	ACM:ModCod Unlock-Action Target-SNR-Margin
2a.	(SELECT) CONFIG: TI → IP-ACM → ModCod Use the ◀▶ arrow keys to select the Min(imum) (on the top line) or Max(imum) ModCod range setting (on the bottom line). Then, use the ▲▼ arrow keys to define the range of ModCods (00-11) over which the system will operate. Press ENTER. ModCod 00 is BPSK Rate 0.488 (0.49 bps/Hz), while ModCod 11 is 16-QAM Rate 0.853 (3.41bps/Hz).	Min Modcod: 00 BPSK .488 Max Modcod: 11 16QAM .853
	 <p>To constrain the system to run at a fixed ModCod, set the Min and Max ModCod values to be equal.</p> <p>The value of Max ModCod may be limited by other FAST codes installed. For example, suppose the 4100 kbps FAST option is installed, and the symbol rate set to 4100 kbps, the theoretical maximum data rate would be 14 Mbps at ModCod 11. However, if CnC is being used, with a 10 Mbps FAST limit the ACM Max ModCod will be limited to ModCod 7, or 9.6 Mbps.</p>	
2b.	(SELECT) CONFIG: TI → IP-ACM → Unlock-Action Use this submenu to establish the desired action when the remote demod loses lock. This is important, as the ACM system depends on the feedback of the SNR metric from the remote demod to determine the optimum ModCod. Use the ▲▼ arrow keys to select Go to min Tx ModCod (recommended) or Maintain Tx ModCod. Press ENTER.	Distant-end loses lock: Go to min Tx ModCod(▲ ▼)



Step	Task	Front Panel VFD Mnemonic
2c.	<p>(SELECT) CONFIG: TI → IP-ACM → Target SNR Margin</p> <p>Use the ▲ ▼ arrow keys to select a margin value from 0.0 to 4.5 dB, in 0.5 dB increments. Press ENTER.</p> <p>This is a VERY important parameter. The ACM system is designed to switch based on thresholds that correspond to a BER of <math>5 \times 10^{-8}</math> for each ModCod. However, in order to prevent oscillation around two ModCods at this exact value, 0.3 dB of hysteresis has been added. The switch points and the hysteresis are shown in Figure P-2.</p>	<p>Target SNR Margin: 1.0 dB (0.0 - 4.5) (▲ ▼)</p>

### P.6.3 Switch Points

Figure P-2 shows the switch points with the Target Eb/No margin set to 0 dB. However, the switch points can be moved (increased) by configuring the Target Eb/No margin parameter, which can vary from 0 to 4.5 dB, in 0.5 dB steps. In a fading environment, it is strongly recommended to add sufficient margin to maintain an adequate link quality (and to maintain demod lock) during the interval between the Eb/No degrading and the ACM controller responding by lowering the ModCod. See **Secion P.9, Notes and Recommendations**.

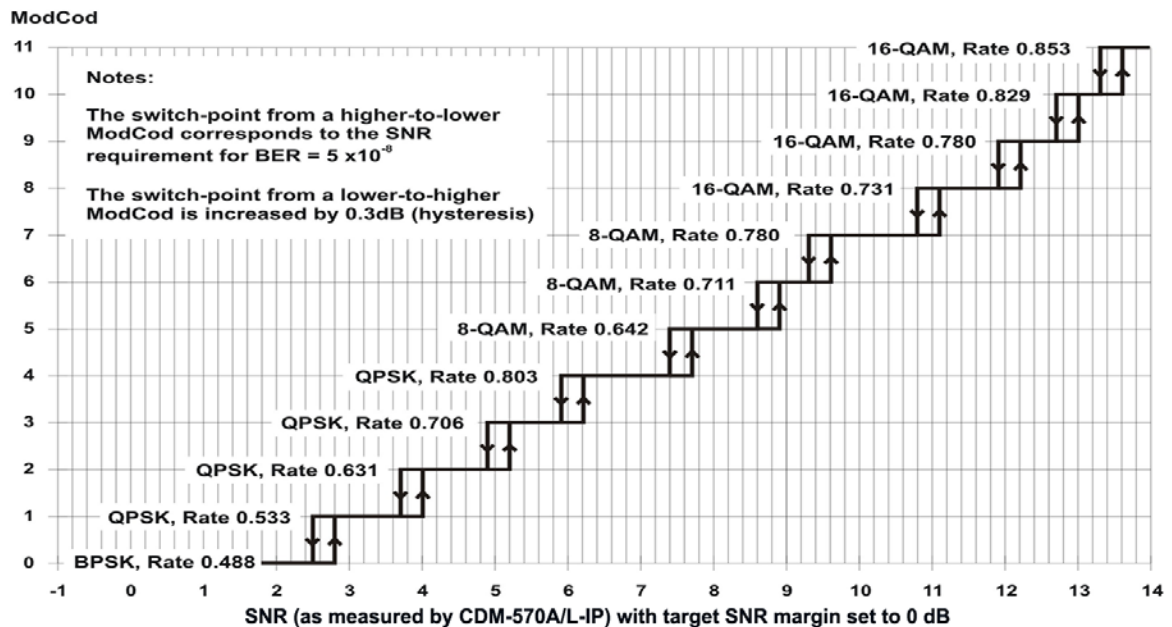

Figure P-2. CDM-570A/570AL-IP ACM ModCod Switch Points

## P.7 Versa FEC-2 ACM (V2-ACM)



### Appendix B.7. FEC (FORWARD ERROR CORRECTION) OPTIONS

#### P.7.1 VersaFEC-2 ACM Latency

**Section P.6.1** addresses latency in VersaFEC ACM mode. The analysis for VersaFEC-2 is proceeds identically. The following table shows a summary for both VersaFEC-2 Long and Short Block modes:

**Table P-2. VersaFEC-2 End-to-End Latency @ 100 kbps**

	Min Throughput @ 100 kbps	Max Throughput @ 100 kbps	End-to-end Latency
VersaFEC-2 Short Block	48.9 kbps	415.3 kbps	40.4 ms
VersaFEC-2 Long Block	48.9 kbps	439.7 kbps	205 ms

As explained in **Section P.6.1**, these figures do not include the WAN buffer latency (where used).

## P.7.2 Configuring VersaFEC-2 ACM



### Chapter 6. FRONT PANEL OPERATION





**VersaFEC-2 ACM requires the plug-in Option Card , and the appropriate FAST code for the maximum operating symbol rate.**

Do these steps to configure the CDM-570A/570AL for VersaFEC-2 ACM operation from the CDM-570A/570AL front panel:

Step	Task	Front Panel VFD Mnemonic
1	(SELECT) CONFIG: TI Use the ◀▶ arrow keys to select a parameter. Press ENTER to set the mode as V2-ACM..	Data Intf: RS422 IP V.35 RS232 G703 IP-ACM V2-ACM
2	(SELECT) CONFIG: TX → FEC Use the ◀▶ arrow keys to select a parameter. Set the Tx FEC type as: <ul style="list-style-type: none"> <li>• VF2L (VersaFEC-2 Long Block), or</li> <li>• VF2S (VersaFEC-2 Short Block)</li> </ul>	TxFEC: Vit Vit-RS TCM-RS TPC VF ULL VF2L VF2S Unc
3	(SELECT) CONFIG: TX → SYMB Use the ◀▶ and ▲▼ arrow keys to enter the desired transmit symbol rate. Note that this is a fundamental departure from the way in which the modem is typically configured.	TxSymRate: 00031.139kbps 00031.139kbps (◀▶,▲▼,ENT)
	 <p>The Transmit symbol rate is limited by the ACM FAST code installed. There are five options:</p> <ul style="list-style-type: none"> <li>• 37 kbps to 375 kbps</li> <li>• 37 kbps to 750 kbps</li> <li>• 37 kbps to 1500 kbps</li> <li>• 37 kbps to 2000 kbps</li> <li>• 37 kbps to 3000 kbps</li> </ul>	
4	(SELECT) CONFIG: TX → POWER Use the ◀▶ arrow keys to select a parameter. Set the Power as: <ul style="list-style-type: none"> <li>• Manual</li> <li>• AUPC</li> <li>• CnC-APC</li> </ul> <p>If <b>Manual</b> mode is selected, enter the desired transmit output level. This will also be the Nominal Power value if <b>AUPC</b> is selected.</p> <p>If <b>AUPC</b> mode is selected without first selecting IP, IP-ACM, or V2-ACM mode, this message appears:</p>	Output Power Level Mode: Manual AUPC CnC-APC
		<b>Warning! AUPC needs Framed Mode or ACM Mode</b>

Step	Task	Front Panel VFD Mnemonic
4 cont	If AUPC mode is selected with the IP, IP-ACM, or V2-ACM mode previously selected, additional choices are presented: <ul style="list-style-type: none"> <li>• Max-Range</li> <li>• Tx-Alarm</li> <li>• DemodUnlock</li> </ul>	Max-Range Tx-Alarm DemodUnlock (◀ ▶)
	In all case except MEO (which is a very unusual mode) the mode is fixed at <b>Normal</b> . Enter the maximum permitted power increase, between 0.0 and 9.9 dB.	Maximum-permitted Power increase: 3.0dB (◀ ▶, ENT)
	Select an alarm when the max power or minimum ModCod has been reached, or not at all. The choices are: <ul style="list-style-type: none"> <li>• None</li> <li>• Max Power</li> <li>• Mini Modcod</li> </ul>	Tx Alarm: None MaxPower MiniModcod ◀ ▶
5	(SELECT) CONFIG: RX → FEC Use the ◀ ▶ arrow keys to select a parameter. Set the Rx FEC type as: <ul style="list-style-type: none"> <li>• VF2L (VersaFEC-2 Long)</li> <li>• VF2S (VersaFEC-2 Short) Block</li> </ul> Note that this does not have to match the Tx FEC type.	RxFEC: Vit Vit-RS TCM-RS TPC VF U11 VF2L VF2S Unc
6	(SELECT) CONFIG: RX → SYMB Use the ◀ ▶ and ▲ ▼ arrow keys to enter the desired receive symbol rate. Note that asymmetric operation is supported – transmit and receive symbol rates do not have to be equal.	RxSymRate: 0065.066ksps 00031.204kbps (◀ ▶, ▲ ▼, ENT)
7	(SELECT) CONFIG: TI → Use the ◀ ▶ arrow keys to select a parameter. Press ENTER to set the mode as V2-ACM.	Data Intf: RS422 IP V.35 RS232 G703 IP-ACM V2-ACM
8	(SELECT) CONFIG: TI → V2-ACM → ACM Use the ◀ ▶ arrow keys to select a parameter. Press ENTER to set the mode as <ul style="list-style-type: none"> <li>• ModCod</li> <li>• Unlock-Action</li> <li>• Target-SNR-Margin</li> </ul>	ACM:ModCod Unlock-Action Target-SNR-Margin

Step	Task	Front Panel VFD Mnemonic
8a.	<p><b>(SELECT) CONFIG: TI → V2-ACM → ModCod</b> Use the ◀ ▶ arrow keys to select the Min(imum) (on the top line) or Max(imum) ModCod range setting (on the bottom line). Then, use the ▲ ▼ arrow keys to define the range of ModCods over which the system will operate. Press ENTER.</p> <p>The minimum setting for VF2S (VersaFEC-2 Short Block) and VF2L (VersaFEC-2 Long Block) is fixed at ModCod 00 (BPSK Rate 0.489 (0.49 bps/Hz)).</p> <ul style="list-style-type: none"> <li>• For VF2S, the maximum selectable ModCod 35 is 32-ARY Rate 0.831 (4.153 bps/Hz)</li> <li>• For VF2L, the maximum selectable ModCod 37 is 32-ARY Rate 0.879 (4.397 bps/Hz)</li> </ul>	<p><b>Min ModCod:00 BPSK .489</b> <b>Max ModCod:37 32ARY .879</b></p>
	 <p>In VersaFEC-2, the Minimum ModCod is fixed at 00, and the user cannot change it.</p>	
	 <p><b>CAUTION</b> – The value of Max ModCod may be limited by other FAST codes installed. For example, suppose the 3000 ksps FAST option is installed, and the symbol rate set to 3000 ksps, the theoretical maximum data rate would be 10.239 Mbps at ModCod 27. However, if CnC is being used, with a 5 Mbps FAST limit, the ACM Max ModCod will be limited to ModCod 10, or 4.8 Mbps.</p>	
8b.	<p><b>(SELECT) CONFIG: TI → V2-ACM → Unlock-Action</b> This screen is <i>read-only</i>. Press ENTER or CLEAR to return to the previous menu. In the event that the distant-end demod loses lock, the Tx ModCod will automatically go to ModCod 0.</p>	<p><b>Distant-end loses lock:</b> <b>Go to Min Tx Modcod(▲ ▼)</b></p>
8c.	<p><b>(SELECT) CONFIG: TI → IP-ACM → Target SNR Margin</b> Use the ▲ ▼ arrow keys to select a margin value from 0.0 to 4.5 dB, in 0.5 dB increments. Press ENTER. This is a VERY important parameter. The ACM system is designed to switch based on thresholds that correspond to a BER of <math>1 \times 10^{-8}</math> for each ModCod. However, in order to prevent oscillation around two ModCods at this exact value, 0.3 dB of hysteresis has been added.</p>	<p><b>Target SNR Margin:</b> <b>1.0 dB (0.0 - 4.5) (▲ ▼)</b></p>

---

## P.8 Monitoring ACM Performance

The CDM-570A/570AL-IP provides several ways to determine the current state of the ACM system.

Use the front panel menu to select **MONITOR: ACM**. The current Tx and Rx ModCod, along with the Local and Remote SNR, are displayed here. The SNR displays values between -3.0 dB and +22.0 dB, with a resolution of 0.1 dB. If either the local or remote demod is unlocked, the SNR will show 'No Sync'. Of course, under **MONITOR: Rx PARAMETERS**, the Eb/No continues to be displayed corrected for modulation type and code rate, in case you do not wish to deal with SNR values.

If you wish to see the exact detail of the ModCod (data rate, modulation, code rate), then these parameters can be seen under **INFO: TX** or **INFO: Rx**. Furthermore, if you are in a **CONFIG: TX** or **CONFIG: RX** screen, both the symbol rate and data rate are displayed. All of these screens update dynamically, so if a ModCod changes, the parameters are refreshed.

This information is also available through the Remote Control (serial interface), as well as the Web Server, SNMP and Telnet interfaces.

If you wish to use the 'Constellation over Ethernet' application that comes with the released code, it is also informative to see the demodulator changing type 'on the fly'. With no noise, and a modem in a loop on itself, you may wish to experiment with Min and Max ModCod values to drive the adaptation.

Alternately, if you have access to an Oscilloscope in X-Y mode, the Alarms connector provides analog voltages to monitor the constellation. This has the advantage that it will show a change in modulation type instantaneously, unlike the 'Constellation over Ethernet' application, which only updates once per second.

If you wish to verify that link performance is meeting the required level, the internal BERT tester is an excellent tool. When using the IP interface it is not an easy matter to verify BER performance, but the internal BERT will not only do this, but is also tolerant of the change in bit rate that accompanies a change in ModCod. The BERT can be used to confirm that there are no sync losses or bursts of bit errors when a ModCod changes.

---

## P.9 Notes and Recommendations

- VersaFEC and VersaFEC-2 ACM are for point-to-point applications. It is required that both directions on the link run in IP-ACM mode, although the symbol rates do not need to be equal. If you wish to constrain one direction to run in CCM, simply set the Min and Max ModCod to be equal. Note, however, that VersaFEC and VersaFEC-2 cannot be mixed on the same bi-directional link.
- ACM constitutes a closed-loop control system (similar in concept to AUPC) and it should be remembered that like all control systems, the speed at which the system can react is governed by a number of factors, including the time taken to estimate SNR to the required accuracy, and the transport delay over the satellite. Realistically, it can cope with fading and other link impairments that do not exceed 1dB/second (more if Target Eb/No margin is increased).

- The ACM controller algorithm that resides in the CDM-570A/570AL-IP does not have to switch through ModCods sequentially – it can change, if needed, directly from ModCod0 to ModCod11 (or vice versa). When the demod first locks at ModCod0 the ACM controller will examine the SNR from the remote end and switch directly to the ModCod that maximizes throughput.
- While ACM can do remarkable things, the fundamentals still apply. Don't expect the demod to run at a 16-QAM ModCod if the SNR instantaneously drops to 0dB – the demod will lose lock and the system will recover by switching to ModCod0 (if so configured).



**For VersaFEC to achieve the most robust link performance, Comtech EF Data strongly recommends that you set the Minimum ModCod to 0 (the ModCod of last resort) and set the Unlock Action to 'Go to minimum ModCod'. This allows the most robust link performance.**

**VersaFEC-2 automatically fixes the minimum ModCod to 0, and the Unlock action is fixed to force the Tx side to automatically go to ModCod 0.**

- For VersaFEC running in ACM mode, the demodulator is performing *blind acquisition* – meaning that it has no *a priori* knowledge of the modulation type or code rate. For this reason the demodulator acquisition time will be slower than in CCM mode. However, the acquisition time is typically under 1 second for all symbol rates and noise conditions.  
For VersaFEC-2 running in AMC mode, acquisition is always at ModCod 0, so acquisition time is considerably quicker than VersaFEC.
- Running the ACM link with the Target Eb/No Margin set to 0 dB will give the best utilization of link power, but in conditions of fast fading may cause demod unlock events, or highly degraded BER just prior to the switch to a lower ModCod. In order to mitigate this, we recommend a Target Eb/No Margin of at least 1dB – more if the fading events are particularly severe and/or frequent.
- For VersaFEC, the value of Max ModCod may be limited by other FAST codes installed in the CDM-570A/570AL. For example, suppose the 3000 kbps FAST option is installed, and the symbol rate set to 3000 kbps, the theoretical maximum data rate would be 10.239 Mbps at ModCod 11. However, if CnC is being used with a 5 Mbps FAST limit, then ACM Max ModCod will be limited to ModCod 4, or 4.83 Mbps. Therefore, if it is not possible to set the Maximum ModCod to the desired value for a given symbol rate, you should check to determine what other FAST codes may be limiting it. The same applies for VersaFEC-2.
- The BER versus Eb/No performance of the ModCods is identical to the VersaFEC CCM modes described in the FEC Options Chapter.
- SNR is the preferred metric for driving the adaptation – this is the value displayed on the monitor screens. If you want to convert this to Eb/No then remember that the relationship is simply  $Eb/No = SNR - 10_{\log}(\text{Spectral Efficiency})$ .
- To achieve minimum latency, set the WAN buffer to the smallest practical value. This will depend on how well the connected equipment implements rate limiting, and the variation in IP packet size. The default setting is 20 ms for VersaFEC, and 100 ms for VersaFEC-2.
- ACM and AUPC are supported at the same time.
- All IP features that are available in the CDM-570A/570AL-IP (VLAN, QoS, etc) are available when in IP-ACM mode. The Sub-Mux feature, however, is not available.
- VersaFEC ACM and VersaFEC-2 are 100% compatible with Carrier-in-Carrier (CnC).

- If required, VersaFEC ACM may be used in conjunction with any of the EDMAC codes, either for serial remote control of the remote modem, or for SNMP proxy. It should be emphasized, however, that unlike AUPC, a framing mode is *not* required for SNR reporting.
- ACM maximizes throughput not only when  $E_b/N_0$  varies due to atmospheric conditions, but will also mitigate the effects of other impairments, such as antenna pointing error, excessive phase noise and certain types of interference. However, rapidly fluctuating impairments (~ less than 1 second) such as scintillation at low antenna look-angles at C-band will generally not be improved by ACM.
- VersaFEC ACM modes **are not** compatible with VersaFEC CCM modes, due to differences in frame preambles. However, VersaFEC-2 ACM and CCM modes **are** compatible.



## P.10 Summary of Specifications

### P.10.1 VersaFEC ACM

System Type	Adaptive Coding and Modulation, using BPSK, QPSK, 8-QAM , 16-QAM and VersaFEC short-block LDPC coding – total of 12 ModCods
Symbol Rate Range	37-3000 ksps
Interface	10/100 Base T Ethernet, with auto-negotiated Congestion Control
Remote SNR Reporting	Automatically reported from remote modem – built in function at the physical layer – requires no additional overhead
Max Span of Data Rate	7:1 over range of adaptation
Switch Point (decreasing SNR)	Corresponds to SNR (Eb/No) that gives BER = $5 \times 10^{-8}$
Switch Point Hysteresis	0.3 dB
Max Fading Rate	Approximately 1 dB/second (higher if Target Eb/No margin >1 dB)
Max ModCod Update Rate	One update every two seconds (no restriction on distance between ModCods)
Configurable Parameters	<ul style="list-style-type: none"> <li>• Minimum and Maximum ModCod (ModCod0 through ModCod11)</li> <li>• Remote Demod Unlock Action: Maintain current ModCod Go to minimum ModCod</li> <li>• Target Eb/No margin (0-4.5 dB, 0.5 dB steps)</li> </ul>
System Latency	54 ms max. (for a system operating at 100 ksps, and assuming a WAN buffer of 20 ms, not including satellite path)
Monitored Parameters	<ul style="list-style-type: none"> <li>• Tx and Rx ModCods</li> <li>• Local and Remote SNR (-3.0 to +22.0dB, 0.1dB resolution, <math>\pm 0.5</math> dB accuracy)</li> <li>• Config and monitor menus displaying data rate, modulation and code rate update dynamically with ModCod</li> </ul>
List of ModCods	See Appendix B, Table B-3

## P.10.2 VersaFEC-2 ACM

System Type	Adaptive Coding and Modulation, using BPSK, QPSK, 8-ARY, 16-ARY, 32-ARY and VersaFEC-2 Short-block and Long Block LDPC coding - total of 74 ModCods
Symbol Rate Range	5 ksps to 3.0 Msps (Long)
Interface	10/100 Base T Ethernet, with auto-negotiated Congestion Control
Remote SNR Reporting	Automatically reported from remote modem – built in function at the physical layer – requires no additional overhead
Max Span of Data Rate	9:1 over range of adaptation
Switch Point (decreasing SNR)	Corresponds to SNR (Es/No) that gives BER = $1 \times 10^{-8}$ (margin set to 0 dB)
Switch Point Hysteresis	0.3 dB
Max Fading Rate	Approximately 1 dB/second (higher if Target Eb/No margin > 1 dB)
Max ModCod Update Rate	1 update every 1.7 seconds
Configurable Parameters	<ul style="list-style-type: none"> <li>• Maximum ModCod (ModCod00 through ModCod37, Long Block)</li> <li>• Maximum ModCod (ModCod00 through ModCod35, Short Block)</li> <li>• Remote Demod Unlock Action: Go to minimum ModCod</li> <li>• Target SNR margin (0 to 4.5 dB, 0.5 dB steps)</li> </ul>
System Latency @ 100 ksps	Long Block - 205 milliseconds max (not including WAN buffer, or satellite path) Short Block – 40.4 milliseconds max (not including WAN buffer, or satellite path)
Monitored Parameters	<ul style="list-style-type: none"> <li>• Tx and Rx ModCods</li> <li>• Local and Remote SNR (-3.0 dB to +22.0dB, 0.1dB resolution, +/- 0.5 dB accuracy)</li> <li>• Config and monitor menus displaying data rate, modulation and code rate update dynamically with ModCod</li> </ul>
List of ModCods	See Appendix B, Tables B-6 and B-7

# Appendix Q. DEDICATED MANAGEMENT PORT FEATURE

## Q.1 Overview

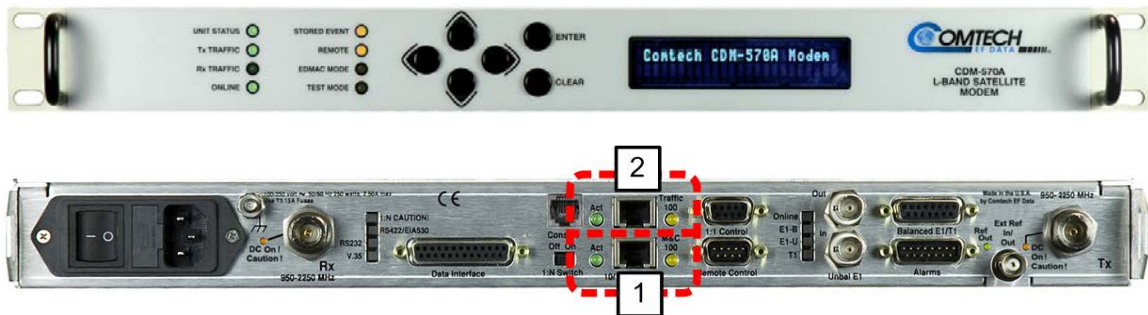

**Figure Q-1. CDM-570A/570AL Advanced Satellite Modem**

The CDM-570A/570AL Advanced Satellite Modem (**Figure Q-1**) provides a “Dedicated Management Port” function. When you use a single Ethernet port for both modem management (referred to as monitor and control, or M&C) and user data traffic, this not only causes many security issues, it also creates difficulties when converging two networks to a single port. Dedicated Management Port operation mitigates these issues.

Dedicated Management Port is available in the Managed Switch, Router Point-to-Point, and Router Point-to-Multipoint working modes when the optional High-Performance Packet Processor is installed and enabled. With Dedicated Management Port, the CDM-570A/570AL uses the modem’s onboard ‘10/100 Ethernet | M&C 100’ port (**Figure Q-1, Item 1**) for M&C access, and the Packet Processor ‘10/100 Ethernet | Traffic 100’ port (**Figure Q-1, Item 2**) for Ethernet data traffic. This allows you to separate the M&C and traffic networks, and restricts user access for modem M&C to the “dedicated” port.

## Q.2 Dedicated Management Port – Description



**Dedicated Management Port operation must be enabled *at both ends of the network* in order to work properly!**

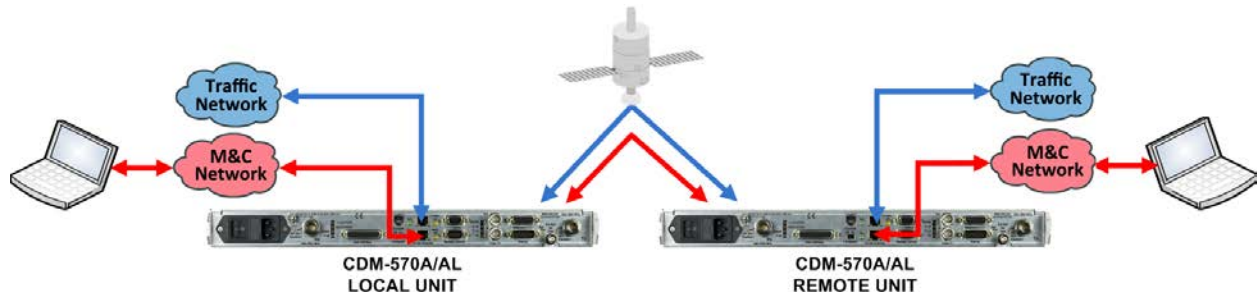

**Figure Q-2. CDM-570A/570AL Dedicated Management Port Operation**

**Figure Q-2** shows the local and distant-end (remote) networks with Dedicated Management Port operation enabled. As shown here, the modem on the local M&C network can access both local and distant-end modem M&C without compromise by packet mixing from the Ethernet traffic network.

Similarly, packets from the traffic network can only be routed or bridged to the remote end without compromising packet mix from the management network.

### Q.2.1 Configure Dedicated Management Port

By default, Dedicated Management Port operation is disabled. You may enable or disable Dedicated Management Port operation only by using the Serial Command Line Interface (CLI). All other configuration parameters associated with enabled Dedicated Management Port operation are available through the other available M&C interfaces.



1. **The configuration instructions and examples that follow address modem M&C via the CDM-570A/570AL Serial CLI. See your CDM-570A/570AL Installation and Operation Manual (CEFD P/N MN-CDM570A) for detailed instructions on using the CLI and other M&C interfaces.**
2. **Make sure that you save any parameter changes before you access a different CLI screen. Press 'S' to "Save Parameters to permanent storage" otherwise your changes will be lost.**

As shown in **Figure Q-3**, the **Ethernet Interface** page appearance differs depending on the active Working Mode – Managed Switch Mode (see **Sect. Q.3**) versus Router Mode (see **Sect. Q.4**). Do these steps:

1. From the Serial CLI **Main Menu**, press 'I' to open the **Interface Configuration** menu.
2. On the **Interface Configuration** menu, press 'E' to open the **Ethernet Configuration** menu.
3. On the **Ethernet Configuration** menu, press 'D' to set Dedicated Management Port operation. Your available choices depend on your active Working Mode:

- a. If you are in Managed Switch Mode, press '2' to enable Dedicated Management Port in **Local ONLY Mode**, or '3' to enable Dedicated Management Port in **Local & Remote Mode**.
- b. If you are in Router Mode, press '2' to enable Dedicated Management Port operation.

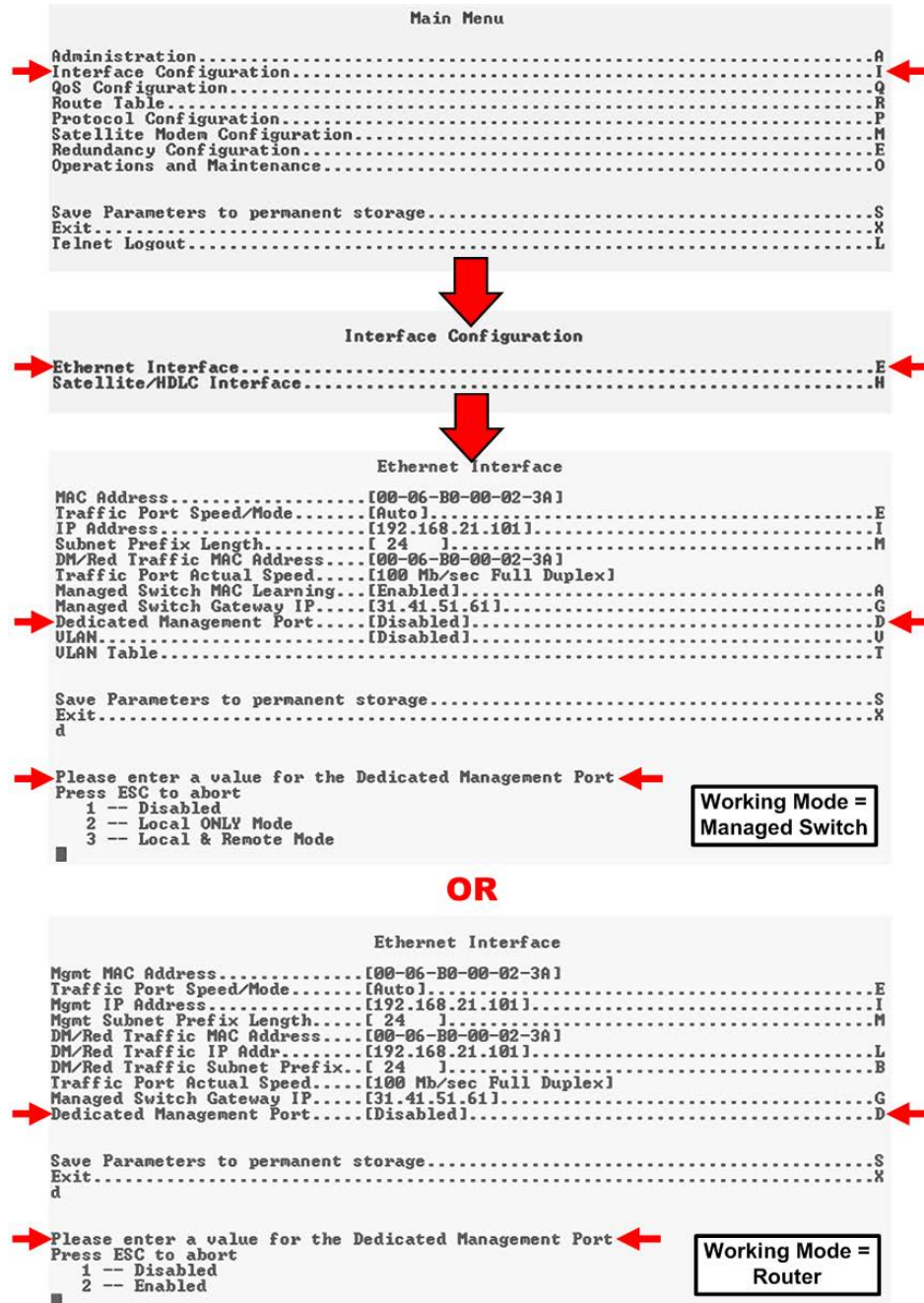
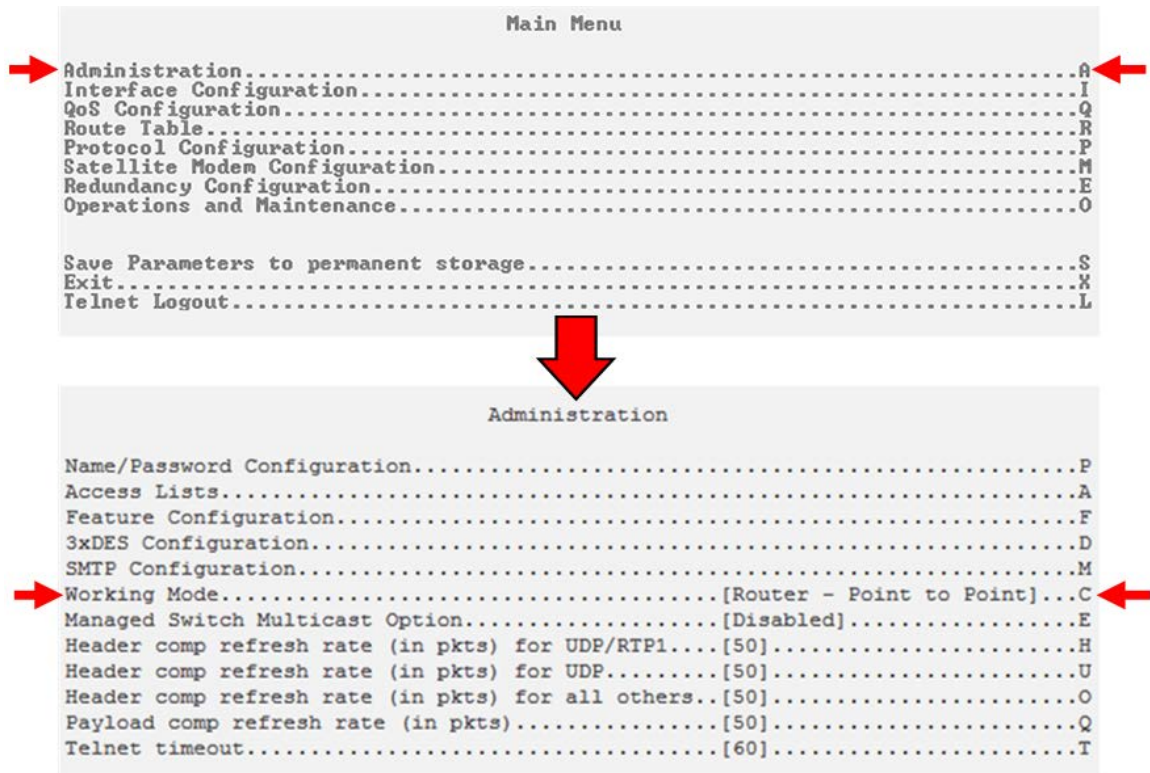

Figure Q-3. CDM-570A/570AL Dedicated Management Port Configuration

### Q.3 Working Mode = Managed Switch Mode



**Figure Q-4. CDM-570A/570AL Working Mode Configuration**

The **Figure Q-4** example shows the active Working Mode as Router – Point to Point. You must change your active Working Mode to Managed Switch.

1. To change your active Working Mode:
  - From the Serial CLI Main Menu, press 'A' to open the Administration Menu.
  - On the Administration menu, press 'C' to display the Working Mode choices. Press '5' to select **Managed Switch** Working Mode.
2. Enable your specific mode of Managed Switch Dedicated Management Port operation. As shown previously in **Figure Q-3**:
  - On the Ethernet Interface menu, press 'D' to display the Dedicated Management Port operation choices; then, press '2' for **Local ONLY Mode**, or press '3' for **Local & Remote Mode**.

In Managed Switch Mode, Dedicated Management Port operation does not require any additional configuration. The previously configured Management IP Address will be assigned to the '10/100 Ethernet | M&C 100' (Dedicated Management) port. The '10/100 Ethernet | Traffic 100' port, in Managed Switch Mode, does not require an IP address.

### Q.3.1 Managed Switch Mode – Local ONLY Mode

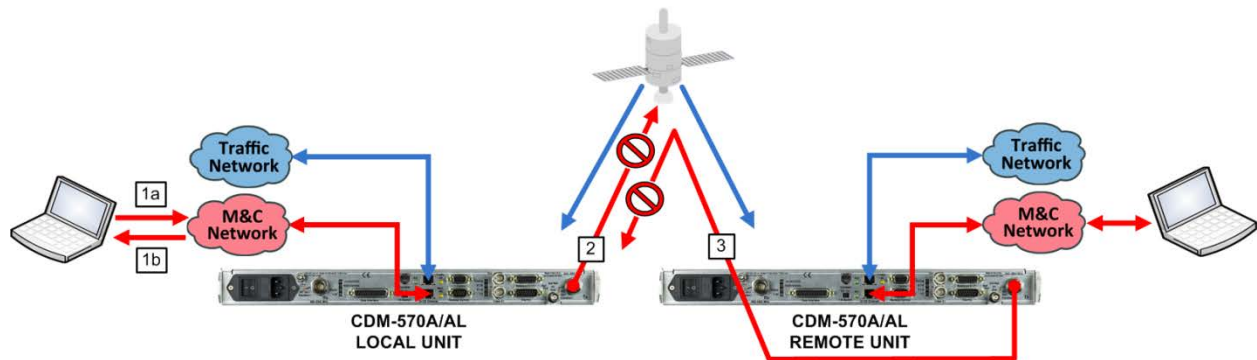

**Figure Q-5. CDM-570A/570AL Operation – Local ONLY Mode**

**Local ONLY Mode** limits modem M&C access only through the '10/100 Ethernet | M&C 100' (Dedicated Management) port. It will not allow modem M&C access over the WAN interface (i.e., the '10/100 Ethernet | Traffic 100' port).

As shown in **Figure Q-5**, Local ONLY Mode:

- Allows local modem M&C access **only** through the local modem's '10/100 Ethernet | M&C 100' (Dedicated Management) port:
  - **1a.** Dedicated Management permits User PC M&C access to the local modem '10/100 Ethernet | M&C 100' port.
  - **1b.** The local modem accepts M&C communication from the User PC and responds accordingly.
- Does **not** allow M&C access to the local modem through the '10/100 Ethernet | Traffic 100' port.
- Does **not** allow M&C access to the distant-end modem over the WAN:
  - **2.** Packets transmitted via Dedicated Management Port to the distant-end modem will be dropped by the local modem.
- Does **not** allow M&C access to the local modem from the distant-end modem, whether or not either modem is in Dedicated Management mode:
  - **3.** Packets received, by the local modem (intended for local modem M&C access), from the distant-end modem will be dropped.

### Q.3.2 Managed Switch Mode – Local & Remote Mode

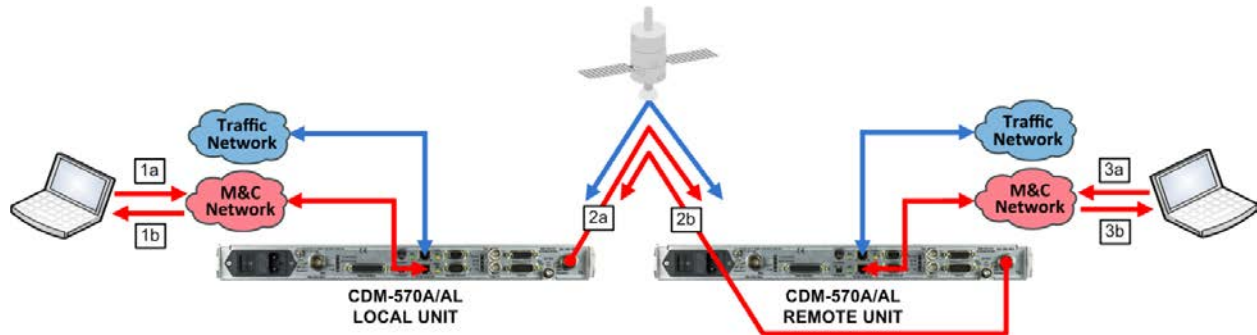

**Figure Q-6. CDM-570A/570AL Operation – Local & Remote Mode**

In Local & Remote Mode, you can access M&C for both the local and distant-end modems.

As shown in **Figure Q-6**, Local & Remote Mode:

- Allows modem access through the '10/100 Ethernet | M&C 100' (Dedicated Management) port for both the local and distant-end modems:
  - **1a.** The '10/100 Ethernet | M&C 100' (Dedicated Management) port permits User PC M&C access to the local modem.
  - **1b.** The local modem accepts M&C communication from the User PC and responds accordingly.
  - **2a.** Packets destined to the distant-end modem from the local modem will be transmitted.
  - **2b.** M&C requests transmitted by the distant-end modem to the local modem will be forwarded back to the local User PC.
  - **3a.** Packets received by the distant-end modem for M&C access from the local modem will be accepted.
  - **3b.** The local modem will transmit a response to the distant-end modem.
- Does **not** allow M&C access to the local or distant-end modem through the '10/100 Ethernet | Traffic 100' Ethernet port.



## Q.4 Working Mode = Router Mode (Point-to-Multipoint / Point-to-Point / Vipersat)

### Q.4.1 Configure Router Mode

Do these steps:

1. Use the CDM-570A/570AL Serial CLI to set your active Router Working Mode. As shown previously in **Figure Q-4** from the Administration menu, press 'C' to display the available choices:

Press	For Router Mode:	Description
1	Small Network	Router uses 1 byte HDLC addresses
2	Large Network	Router mode using 2 byte HDLC addresses
3	Point to Point	Router mode uses 0 HDLC addresses to save satellite bandwidth
4	Vipersat	Router mode when running in a Vipersat Network
5	Managed Switch	N/A (see Sect. Q.3)

2. Enable Dedicated Management Port operation. As shown previously in **Figure Q-3**, on the **Ethernet Interface** menu, press 'D' to display the Dedicated Management Port operation choices; then, press '2' to Enable.
3. Dedicated Management Port, when used in Router Mode, requires two IP Addresses (**Figure Q-7**):
  - One for M&C (management) – the '10/100 Ethernet | M&C 100' port;
  - One for Traffic (Ethernet data) – the Traffic 100 port.

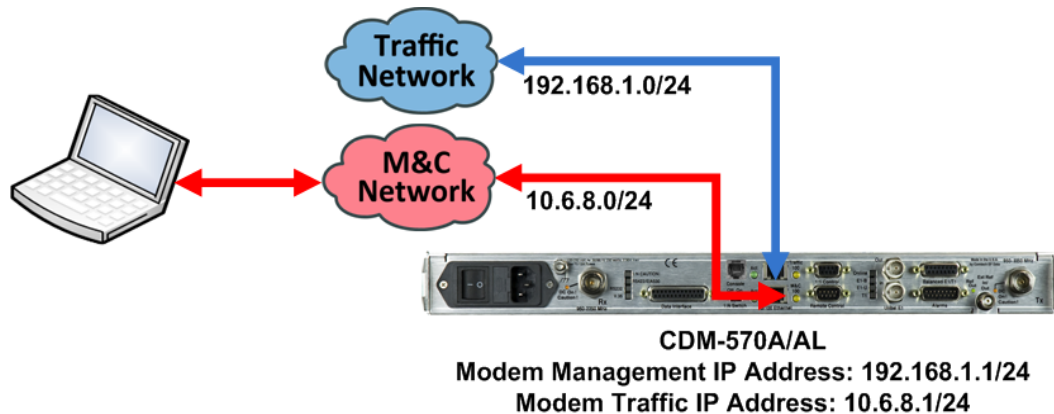

**Figure Q-7. CDM-570A/570AL Router Mode IP Addresses**



**When Dedicated Management Port is disabled, the existing Management IP Address is used for both M&C and traffic.**

When you first enable Dedicated Management Port, the existing single IP Address is assigned automatically as the Management IP Address – you are required to configure the Traffic IP Address(es) (**Figure Q-8**):

- a. From the Serial CLI Main Menu, press 'I' to open the Interface Configuration menu. Then, press 'E' to open the Ethernet Configuration menu.
- b. On the Ethernet Configuration menu, press 'I' or 'G' to assign the Management and Managed Switch Gateway IP Addresses, respectively.
- c. On the Ethernet Configuration menu, press 'L' or 'B' to assign the IP Address and the Subnet Prefix, respectively, for the '10/100 Ethernet | Traffic 100' port. Make sure the Management IP Address and Traffic IP Address are **NOT** in the same subnet.

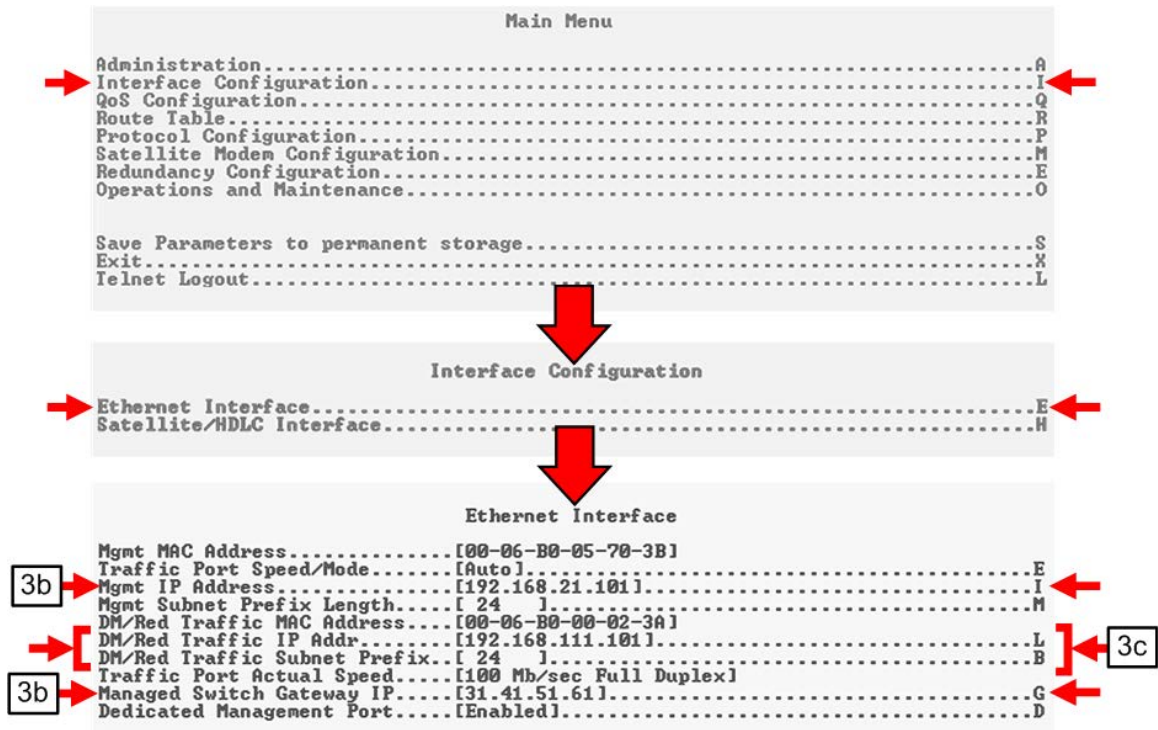
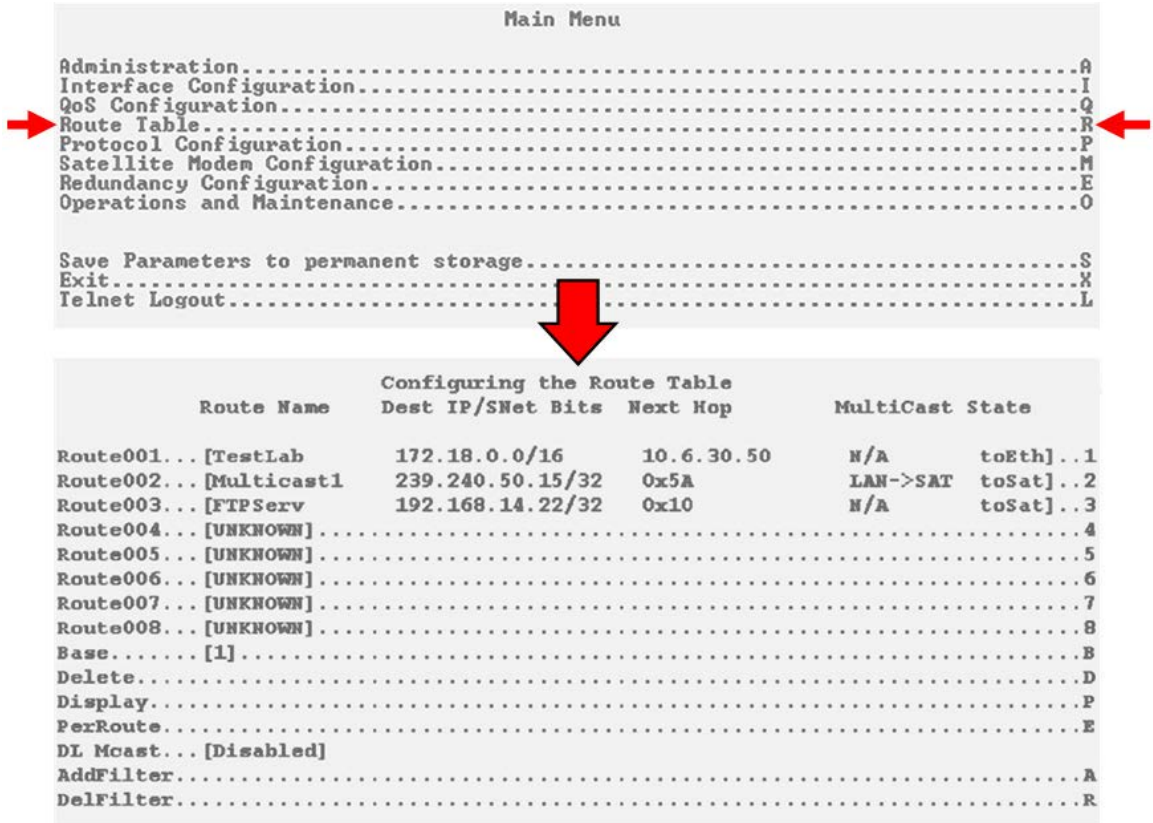

Figure Q-8. CDM-570A/570AL Router Mode – Assign IP Addresses

4. When in Router Mode, you must use Route Tables to allow local and remote M&C access (**Figure Q-9**). To restrict M&C access as **Local ONLY**, you must either delete the existing route, or not configure a route, destined to remote unit's M&C subnet.
  - a. From the Serial CLI Main Menu, press 'R' to open the Route Table menu.
  - b. On Route Table menu, press a number (e.g., '3') to edit an assigned Route, or press 'D' to delete an assigned route.



```

Main Menu
Administration.....A
Interface Configuration.....I
QoS Configuration.....Q
Route Table.....R
Protocol Configuration.....P
Satellite Modem Configuration.....M
Redundancy Configuration.....E
Operations and Maintenance.....O

Save Parameters to permanent storage.....S
Exit.....X
Telnet Logout.....L
  
```

Configuring the Route Table				
Route Name	Dest IP/SNet Bits	Next Hop	MultiCast State	
Route001... [TestLab	172.18.0.0/16	10.6.30.50	N/A	toEth]..1
Route002... [Multicast1	239.240.50.15/32	0x5A	LAN->SAT	toSat]..2
Route003... [FTPServ	192.168.14.22/32	0x10	N/A	toSat]..3
Route004... [UNKNOWN]				..4
Route005... [UNKNOWN]				..5
Route006... [UNKNOWN]				..6
Route007... [UNKNOWN]				..7
Route008... [UNKNOWN]				..8
Base..... [1]				..B
Delete.....				..D
Display.....				..P
PerRoute.....				..E
DL Mcast... [Disabled]				
AddFilter.....				..A
DelFilter.....				..R

Figure Q-9. CDM-570A/570AL Route Tables

## Q.5 Dedicated Management Port and 1:1 Redundancy Operation

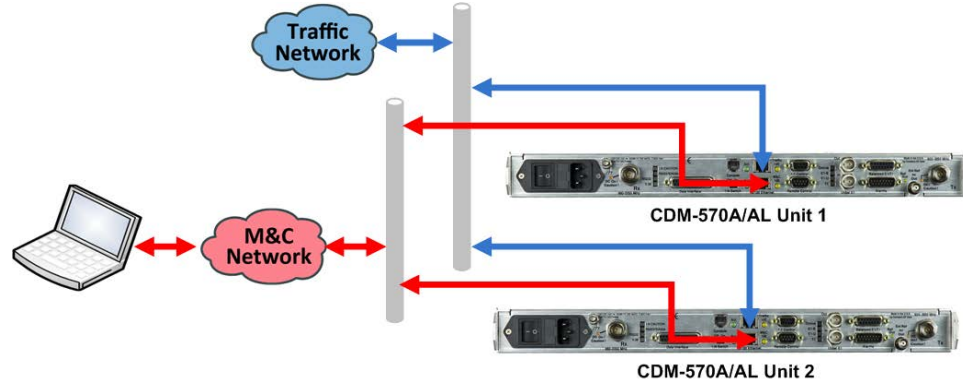

Figure Q-10. CDM-570A/570AL 1:1 Redundancy Operation

For 1:1 Redundancy with Dedicated Management Port disabled, you must connect the online and standby modem '10/100 Ethernet | Traffic 100' ports to the same external switch. However, for 1:1 Redundancy with Dedicated Management Port enabled, you must use separate external switches for the Ethernet data '10/100 Ethernet | Traffic 100' ports (blue) and the '10/100 Ethernet | M&C 100' ports (red). These switches can be either separate physical or logical switches.

### Q.5.1 1:1 Redundancy in Managed Switch Mode



In Managed Switch Mode, no special configuration is required for:

- Enabling 1:1 Redundancy when Dedicated Management Port is enabled;
- Enabling Dedicated Management Port when 1:1 Redundancy is enabled.

```

1:1 Redundancy Configuration
1:1 Redundancy.....[Enabled].....R
1:1 Redundancy State.....[Offline]
Traffic IP Address.....[192.168.111.101]
Traffic Subnet Prefix Length.....[ 24 ]
Management IP Address (Local Unit).....[192.168.21.101]
Management Subnet Prefix Length (Local Unit).....[ 24 ]
Management IP Address (Redundant Unit).....[192.168.21.104]
Management Subnet Prefix Length (Redundant Unit).....[ 24 ]
Force Unit Offline.....
Redundancy Mode.....[Auto].....A
  
```

```

1:1 Redundancy Configuration
1:1 Redundancy.....[Enabled].....R
1:1 Redundancy State.....[Offline]
Traffic IP Address.....[192.168.21.101]
Traffic Subnet Prefix Length.....[ 24 ]
Management IP Address (Local Unit).....[192.168.21.101]
Management Subnet Prefix Length (Local Unit).....[ 24 ]
Management IP Address (Redundant Unit).....[192.168.21.104]
Management Subnet Prefix Length (Redundant Unit).....[ 24 ]
Force Unit Offline.....
Redundancy Mode.....[Auto].....A
  
```

(TOP) Dedicated Management Port = DISABLED  
(BOTTOM) Dedicated Management Port = ENABLED

Figure Q-11. 1:1 Redundancy Configuration in Managed Switch Mode

## Q.5.2 1:1 Redundancy in Router Mode



### In Router Mode:

- If Dedicated Management Port is enabled before 1:1 Redundancy is enabled, no special configuration is required. 1:1 Redundancy will use the Management IP Address for redundancy communications between the online and standby modems. The Traffic IP Address will be used as the Traffic IP Address only – the online modem configures the Traffic IP Address.
- If 1:1 Redundancy is enabled before Dedicated Management Port is enabled, no special configuration is required. Dedicated Management Port will use the Management IP Address as the Management IP Address. The Traffic IP Address will be used as the Traffic IP Address.

Whether only Dedicated Management is enabled, or only 1:1 Redundancy is enabled, or both are enabled, you are required to configure both the Management and Traffic IP Addresses. Both Dedicated Management Port and 1:1 Redundancy use the Management IP Address for M&C traffic, and the Traffic IP Address for Ethernet data traffic. No special configuration is otherwise required.



# Appendix R. CARRIER ID (DVB-CID METACARRIER<sup>®</sup>)

---

## R.1 Overview

CDM-570A/570AL Satellite Modems incorporate a patent-pending carrier identification (CID) technique that uses MetaCarrier<sup>®</sup> spread spectrum technology to embed a unique carrier identification sequence for the transmitted carrier.

The CDM-570A/570AL with MetaCarrier<sup>®</sup> is used in tandem with the Comtech EF Data MCDD-100 MetaCarrier<sup>®</sup> Detection Device to provide a complete MetaCarrier embedding and decoding solution.

Since the initial release of this technology in the CDM-570A/570AL, the European Telecommunications Standards Institute (ETSI) has adopted a modified version of Comtech's original scheme, which is defined in **ETSI TS 103 129 – Digital Video Broadcasting (DVB) Framing Structure, Channel Coding and Modulation of a Carrier Identification System (DVB-CID) for Satellite Transmission**. CDM-570A/570ALs running Firmware Version 1.5.2 or later fully comply with this new ETSI specification.

---

## R.2 About MetaCarrier

The DVB-CID (MetaCarrier) concept employs a low-speed data sequence containing identifying information about a host carrier that is spread using Direct Sequence Spread Spectrum (DSSS), and then combined, at a low power level, directly underneath that host carrier. The composite signal therefore carries its own embedded identification. The power level and bandwidth of the MetaCarrier is sufficiently low that it is completely hidden below the host carrier, and has minimal effect on system Eb/No (approximately 0.1 dB).

DVB-CID operates independent of the modulation and Forward Error Correction (FEC) rate of the host carrier. In configurations where the carrier is encrypted or uses cryptographic technologies, the information carried in the DVB-CID is not affected.

Traditionally, the method for identifying an interfering carrier involves using a geo-location system that, in turn, uses the phase offset from an adjacent satellite to triangulate the approximate location on the surface of the earth where the interference is being generated. While such "tried-and-true" geo-locating methods have proven beneficial to satellite operators and service providers, they are nevertheless imprecise. For example, to find the exact location of the transmission source in a densely populated area, you must dispatch a helicopter equipped with a feed horn and spectrum analyzer; the time and cost associated with such methods are significant.

By contrast, Comtech EF Data's DVB-CID provides you with the interference source's identification information within seconds. Once you identify the offending carrier, you may then contact the uplinking station and request that the station shut down or otherwise remove the identified transmission from service.

### R.3 Functional Description

In a typical network, there can be many CDM-570A/570ALs with DVB-CID, and one (or more) MCDD-100 MetaCarrier Detection Devices to verify the presence of the DVB-CID on each carrier. In an interference situation, the MCDD-100 may be used to decode the DVB-CID of an interfering carrier that may not be part of one's own transmission network, as long as the interfering carrier has an embedded DVB-CID.

The CDM-570A/570AL creates a composite carrier by first sizing the appropriate MetaCarrier, and then by adding the spread spectrum CID (at a highly reduced power spectral density compared with that of the host carrier).

The size of the MetaCarrier is determined based purely on symbol rate and is totally independent of modulation and coding, resulting in two (2) discrete sizes of MetaCarrier being combined with the host carrier. The MetaCarrier parameters are shown below:

Host Carrier	Embedded DVB-CID MetaCarrier	DVB-CID psd relative to host carrier psd
128 ksps to < 512 ksps	112 kchips per sec *	-27.5 dB
512 ksps to < 2048 ksps	224 kchips per sec	-27.5 dB
2048 ksps to < 4096 ksps	224 kchips per sec	-24.5 dB
4096 ksps to < 8192 ksps	224 kchips per sec	-21.5 dB
8192 ksps to 12500 ksps	224 kchips per sec	-18.5 dB

\*kchips per sec refers to the direct sequence spread spectrum chipping rate

As shown here, the bandwidth of the host carrier is always wider than the MetaCarrier, the worst case being a 112 kcps MetaCarrier underneath a 128 ksps host carrier. In all configurations of the combined carrier, the MetaCarrier raises the transmission power less than 0.1 dB above the original carrier.



**Note that in accordance with the DVB specification, Carrier ID is only available when the Transmit symbol rate is greater than, or equal to 128 ksps.**

The CID message is composed of the following information:

- **CDM-570A/570AL MAC Address**
- **Contact Telephone Number**
- **Latitude and Longitude**
- **Custom Message**



## R.4 Configuring the CDM-570A/570AL for Carrier ID Operation

Carrier ID operation requires that you first enable Carrier ID feature operation, and then create a MetaCarrier Custom Message. All other parameters (center frequency, symbol rate, and the CDM-570A/570AL's MAC address) are set automatically. The CDM-570A/570AL provides several means for configuring Carrier ID operation:

- Local Control via the CDM-570A/570AL Front Panel keypad and VFD.
- Remote Control with a user-supplied PC via the
  - CDM-570A/570AL HTTP (Web Server) Interface using a compatible Web browser.
  - Serial-based or Telnet-based Remote Control Interface using a terminal emulation program or Windows Command-line.
  - Ethernet-based Simple Network Management Protocol (SNMP) using a Network Management System (NMS) and Management Information Base (MIB) File Browser.



**USE OF THE SERIAL-BASED REMOTE CONTROL INTERFACE, THE TELNET-BASED REMOTE CONTROL INTERFACE, AND THE ETHERNET-BASED SNMP INTERFACE ARE RECOMMENDED ONLY FOR ADVANCED USERS. COMTECH EF DATA STRONGLY ENCOURAGES USE OF THE CDM-570A/570AL FRONT PANEL OR HTTP (WEB SERVER) INTERFACE FOR MONITOR AND CONTROL (M&C) OF THE CDM-570A/570AL.**

### R.4.1 Enabling Carrier ID Operation

#### R.4.1.1 Enabling Operation via the CDM-570A/570AL Front Panel and VFD



**Sect. 6.3.7.9 UTIL: CID (Carrier ID) (Chapter 6. FRONT PANEL OPERATION)**

From the front panel main (**SELECT:**) menu, use the ◀ ▶ arrow keys to select the **Utility** menu branch, and then press **ENTER**. Then, from the **Utilities:** screen, use the ◀ ▶ arrow keys to select the **CID** submenu. Press **ENTER** to continue (the flashing solid block indicates the cursor position upon navigation to that display item):

```
SELECT: Config Monitor
        Test Info Save/Load Util
```

```
UTIL: Buf Clock Ref CMO
      ID 1:1 VFD FW FAST CID
```

```
CarrierID: Off ◀ ▶ ◆
```

Use the ▲▼ arrow keys to select Carrier ID (MetaCarrier) operation as **On**, and then press **ENTER**.

```
CarrierID: On      ◀ ▶ ⬇
  Lat  Long Phone#  Message
```

You are then prompted to enter user supplied data, as follows:

```
CarrierID Lattitude:
33°25.32'N  (◀ ▶ ⬇ , ENT)
```

Edit the latitude (in the form shown – degrees and decimal minutes, North or South) of the location where the CDM-570A/570AL is located using the ▲▼ arrow keys, then press **ENTER**.

```
CarrierID Longitude:
111°58.28'W  (◀ ▶ ⬇ , ENT)
```

Edit the longitude (in the form shown – degrees and decimal minutes, East or West) of the location where the CDM-570A/570AL is located using the ▲▼ arrow keys, then press **ENTER**.

```
CarrierID Phone #:  ◀ ▶ ⬇
+1555555555
```

Enter the telephone number of the person or entity to be contacted in the event that there is an interference problem, using the ▲▼ arrow keys, then press **ENTER**.

```
CarrierID Message:  ◀ ▶ ⬇
  Custom CarrierID Message
```

Enter the custom message that you want to be associated with the particular CDM-570A/570AL satellite link, using the ▲▼ arrow keys, then press **ENTER**.