



# Solutions for Flexible, Efficient and Secure Satellite-based IP Networks

**Jeffrey Harig**  
**Senior Vice President, Engineering**  
**Comtech EF Data**

**Revision 4 – October 26, 2006**

This page is intentionally left blank.

## ABSTRACT

As the growth and deployment of Internet Protocol (IP) high-speed network satellite services continues to expand, the search for flexible, efficient and secure satellite-based IP network solutions continues as well. Comtech EF Data (CEFD) has developed a complete line of IP-enabled modems, performance-enhancing proxies and network management tools to meet these needs.

This paper examines the dilemmas associated with satellite-based IP transport, presents the desired attributes for a satellite-based IP network and defines the powerful product solutions available from CEFD. Finally, it demonstrates a case study for three small, satellite-based IP network implementations and addresses the associated costs for each network.

While the network used in the case study is small, the applications and services provided are representative of real-world requirements; the results are scalable to medium and large networks.

## INTRODUCTION

The rapid growth of IP networks, products and services, fueled over the past two decades by the phenomenal explosion of the World Wide Web, has dramatically changed the content of data over geosynchronous satellite networks worldwide. As recently as ten years ago, voice circuits and frame relay constituted the biggest percentage of data traversing these satellite networks.

Today, the convergence of voice, video and data products and services all carried over IP based networks has infiltrated and changed all facets of daily business and life. High speed Internet, online banking and bill paying, voice and data services via cell phones, Internet phone services, and on-demand video distribution are just some of the services readily available and affordable today where, a decade earlier, they could only be imagined in sci-fi movies.

As depicted in Figure 1, Voice over IP and Video over IP has had much more penetration, to date, into the corporate world than in the consumer world.

Once interesting engineering concepts with limited use in the real world, Voice over IP and Video over IP are now widespread and must be part of any satellite networking solution.

### Internet phone calling small but growing

Share of telephone lines in the USA

● Traditional ● Voice over Internet

#### Business Lines

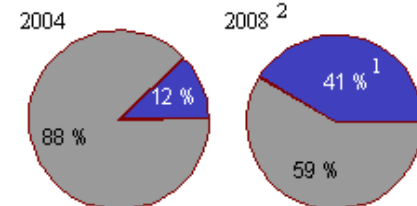

#### Consumer Lines



1 - Businesses with at least part of their phone system using voice over Internet. 2 - Estimate

Source: In-Stat/MDR

**Figure 1. Business vs. Consumer Line Use**

## I. DESIRED NETWORK ATTRIBUTES

The expectations and desires for consumers of this revolution of products and services are simple: lowest price, highest performance, strongest security and most reliability. Interestingly enough, these expectations and desires are also directly in line with those of the satellite network providers:

- **Lowest possible life cycle cost**
- **High efficiency**
- **Effective content control**
- **Full bandwidth utilization**
- **Strong security**
- **Easy to install, manage and operate**
- **Adaptability**

### LOWEST POSSIBLE LIFE CYCLE COST

The paradigm of increasing functionality and performance – while reducing cost to the end customer – is one of the toughest obstacles facing the satellite industry as this IP revolution continues.

The complexity and prohibitive life cycle cost (including installation, training and maintenance) of classic ‘multiple black box’ architectures can limit chances for success. Higher levels of integration between classic satellite modems and IP network gear are required to satisfy this paradigm.

### HIGH EFFICIENCY

This IP revolution has changed the content destined for the satellite but one constant remains unchanged: The cost per bit over the satellite is still tenfold the cost to transmit a bit over copper or fiber terrestrial links.

As shown in Figure 2, IP, Transmission Control Protocol (TCP) and User Datagram Protocol (UDP) protocols have been developed and refined during the past decade’s explosion of the World Wide Web. These protocols have served their purpose very well; however, these protocols have been developed with robustness, flexibility and adaptability as the primary design constraints, and with the assumption of copper or fiber transport.

Transport bandwidth has been assumed to be large enough to limit any concerns about framing efficiency; as a result, the migration to IP over satellite has been slowed due to IP framing inefficiencies and high cost per customer data bit.

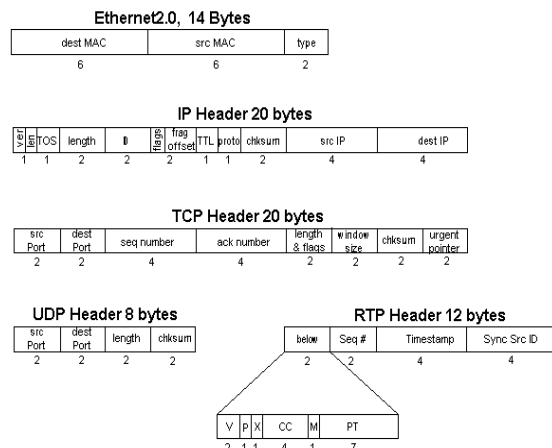

Figure 2. IP Networking Protocols

To overcome these inefficiencies, new satellite modem technology with the best Forward Error Correction (FEC) and higher order modulation combinations are needed. Additionally, very efficient satellite link layer framing, IP protocol header compression and lossless datagram compression are needed.

### EFFECTIVE CONTENT CONTROL

Even after the efficiency problems are overcome, a number of other difficulties still exist for the satellite provider and network designer. The ubiquitous nature of the World Wide Web and voice/video/data services has created a new, unique problem for the satellite provider. In the old circuit-oriented world, the data presented at the satellite modem interface was well controlled and understood.

In the new packet-oriented world of IP networks, traffic shaping and content filtering is a necessity, as illustrated in Figure 3. At the content level, all IP packets are not created equally. The criticality of data traffic carried on most organizations' IP networks vary widely. For instance, sales, procurement and accounting data (File Transfer Protocol (FTP) or database applications) is generally on one end of the spectrum, while web surfing is on the other end of the criticality scale.

Similarly, the latency and jitter requirements of packetized voice and video generally means this traffic needs preference over e-mail. The criticality of the IP traffic on an organization's network will differ from organization to organization, and the higher cost per bit over the satellite requires flexible, new control for the satellite provider. This Quality of Service (QoS) control must go beyond the simple Differentiated Services (DifServ) widely used on terrestrial IP networks today.

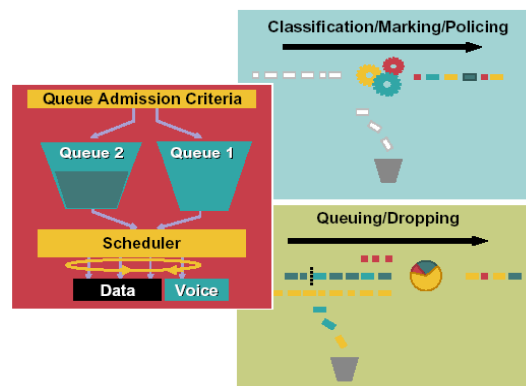

**Figure 3. Traffic Shaping and Content Filtering**

This Quality of Service (QoS) control must go beyond the simple Differentiated Services (DifServ) widely used on terrestrial IP networks today.

### FULL BANDWIDTH UTILIZATION

An additional, significant problem exists with the very nature of the TCP protocol. TCP was developed to provide a guaranteed transport for IP packets. Unlike UDP, TCP is a session-oriented protocol that relies on two-way communication between the sender and receiver. TCP packets are sequenced (tagged), and the recipient must acknowledge the receipt or the sender is obligated to resend them.

TCP protocol also incorporates an algorithm to avoid network congestion by starting slowly and then ramping up the rate of packet transmission based upon how quickly the recipient acknowledges the receipt of sent packets. This algorithm has been tuned for a typical terrestrial network round trip time of less than 50 milliseconds. The round trip time for a typical geosynchronous satellite link is on the order of ten times this worst-case terrestrial time; the result is that any application using TCP protocol over the satellite will never leave the 'slow start' state of the algorithm. This means that the maximum transfer rate for any TCP session over the satellite will be protocol-limited, rather than satellite bandwidth-limited.

FTP, Hyper Text Transfer Protocol (HTTP) and Simple Mail Transfer Protocol (SMTP) are three of the most commonly used TCP applications. For example, with default Microsoft TCP configuration, the maximum transfer rate for FTP over the satellite is around 240 kilobits per second (kbps), far less than transfer rates generally considered acceptable on terrestrial networks. Without a solution to this problem, the effectiveness and viability of satellite-based IP networks is in serious doubt. A number of techniques, protocols and products known as either Performance Enhancing Proxies (PEP) or TCP accelerators have been developed to address this issue.

### STRONG SECURITY

The more we know about IP, the less suitable for an IP network the satellite seems! Remember the brief list of hot new services available through today's IP networks? This explosion of services has created an undesired side effect: theft of corporate and personal intellectual property. The response to this threat has been a parallel explosion of security products and applications. A recent study estimates that revenues in the IP security sector, including Virtual Private Network (VPN) applications and products, will exceed \$20 billion by 2010. How does this affect satellite-based IP networks? The simple answer is that it becomes far more difficult to succeed.

VPNs and other security techniques all have one thing in common – they hide (encrypt) the data. The encryption algorithms, key lengths and key management differ from one technology to the next, but the goal is to make it probabilistically impossible to determine the type and content of the IP packets, including source and destination addresses. Each of the desirable attributes necessary to provide efficient and effective satellite-based IP networks previously described (header compression, datagram

compression, QoS, TCP Acceleration) require visibility into both the headers and payload of the IP packets. However, none of these desirable attributes can be accomplished after the packets are encrypted. If the satellite link is between these encryption-decryption points the optimum network performance cannot be achieved.

### **EASY TO INSTALL, MANAGE AND OPERATE**

The complexity of terrestrial IP networks varies, from simple home or small office topologies containing a simple routing device and limited network elements (personal computers, printers, etc.) to very large corporate networks having many routing devices and network elements spread across large geographic distances. The same varying degrees of complexity can exist in satellite based IP networks. For the typical satellite network designers and operators, the tasks of specifying, installing, configuring and managing the multiplexers, Frame Relay Access Devices (FRADs), digital modems, antenna controllers and Radio Frequency (RF) equipment used in the 'old' circuit-based world can be accomplished routinely. Calculating link budgets and specifying link availability are known quantities. However, making sense of the alphabet soup of IP acronyms, protocols, network topologies and equipment can be an overwhelming task. The next generation of satellite equipment must be designed so that the desirable attributes previously discussed are provided, but the equipment should not require that the operator be "Cisco Certified."

### **ADAPTABILITY**

Today's convergence of voice, video and data has opened up many new and previously unavailable services. We would be very short sighted, however, to think that we've seen the pinnacle of advancement and that new and bigger applications and services aren't on the horizon.

Satellite-based IP networks and networking equipment must be designed with an eye towards the future. Additionally, the available satellite access technology options need to be re-evaluated to determine which is the best solution for each mix of applications now and in the future. No longer does a satellite network design fall easily within a single category of either low-speed, highly-oversubscribed service for 'bursty' data applications, or high-speed, dedicated service for simultaneous data, voice and video.

The shared bandwidth aspect of a Time Division Multiple Access (TDMA) offer and the dedicated bandwidth of a Single Channel per Carrier (SCPC) solution are no longer the only games in town. In other words, the technology is at the stage where it cannot be assumed that a one-size-fits-all mentality exists for satellite networking solutions. In addition to the increase of packetized voice and video over IP content, in some instances cost-effective partial meshing is required in order to provide a solid end-user experience.

Today, on-demand content switching, based both on application and load, is required to support disaster recovery, news gathering and event coverage, to cite just a few examples. A synergy between the TDMA and SCPC worlds is needed to allow satellite service providers to provide a solution that meets the end user's Service Level Agreement (SLA).

It is now time to leverage the bandwidth sharing of a TDMA satellite solution with the dedicated bandwidth nature of an SCPC solution. This requirement is met with CEFD's ability to provide dynamic SCPC (dSCPC), whereby SCPC links are provided on an on-demand basis.

## II. COMTECH EF DATA IP PRODUCTS

Comtech EF Data has developed a line of IP-enabled modem products, PEP products and network control products that provide the building blocks necessary to achieve a satellite-based IP network with all of the desirable attributes previously discussed.



### COMTECH IP-ENABLED MODEMS

CEFD's family of IP-enabled modem products includes:

- Two traditional Modems – the CDM-570 & CDM-570L
- One Dual Demodulator product – the CDD-562
- Two Quad Demodulator products – the CDD-564 & CDD-564L

All are packaged in rack-mountable 1U enclosures. Each product is available in either L-Band or 70/140 Megahertz (MHz) and feature data rates from 2.4 kbps to 9.98 Megabits per second (Mbps), fast acquisition, second generation Turbo Product Coding (TPC) and a variety of modulation techniques. The second generation of TPC is the industry's most bandwidth-efficient forward error correction. TPC provides increased coding gain and lower decoding delay. Featured modulation techniques are Phase Shift Keying (PSK) and Quadrature Amplitude Modulation (QAM) – specifically, 8-PSK, BPSK, QPSK, 8-QAM and 16-QAM, with code rates spanning from Rate 5/16 through Rate 0.95 depending on modulation type.

Designed with IP networking in mind, these robust products optimize satellite communications and provide many of the advanced features previously available only in higher-end modems.

Flexibility and cost-effective performance are integral to these offerings. The CDD-562L Dual Demodulator and CDD-564 and CDD-564L Quad Demodulators are ideally suited for star topologies, reducing both the equipment cost and rack space requirements at the hub.

All four demodulators are fully programmable and independent. Each contains a high performance, feature-rich IP routing engine with standard features, including:

- Choice of routed mode or easyConnect™ for maximum flexibility
- Highly efficient satellite framing (3 to 7 bytes overhead)
- Static IP routing for unicast and multicast
- Support for both Point-to-Point or Point-to-Multi-Point configuration
- Internet Group Management Protocol (IGMP) v1 and v2 for management of multicast groups
- Support for symmetric as well as asymmetric operation for maximum bandwidth efficiency
- Powerful network management via Simple Network Management Protocol (SNMP), Web or Telnet

Also available, as options to the IP Module, are advanced features that focus on providing additional bandwidth efficiencies. These features, including QoS, Header Compression, Payload Compression and 3xDES Encryption, can be enabled at initial purchase or after installation.

## QUALITY OF SERVICE

All CEFD IP-enabled modems are equipped with a state-aware, 7-layer IP classifier to support multi-level QoS. QoS rules can be assigned for up to 32 different types of flows. Flows are defined by any combination of protocol (FTP, UDP, Real Time Protocol (RTP), etc.), Source/Destination IP (specific or range), and/or Layer 3 Source/Destination Port.

The following list of common protocols is provided for selection to simplify QoS rule entry:

Rule name	Description
VOCE	Voice Real Time Protocol
VDEO	Video Real Time Protocol
RTPS	Real Time Protocol Signaling
RTP	All Real Time Protocol
FTP	File Transfer Protocol
HTTP	Hypertext Transfer Protocol
TELNET	Telnet Protocol
SMTP	Simple Mail transfer Protocol
SNMP	Simple Network Management Protocol
SQL	Structured Query Language Protocol
ORCL	ORACLE Protocol
CTX	CITRIX Protocol
SAP	Service Announcement Protocol
UDP	All User Datagram Protocols
ICMP	Internet Control Message Protocol
TCP	All Transmission Control Protocols
IP	All Internet Protocols
N-IP	All Non-Internet Protocols

The QoS system minimizes jitter and latency for real time traffic, such as Voice over IP or Video over IP, provides priority treatment to mission critical applications and still allows non-critical traffic to use the remaining bandwidth for maximum utilization. Three unique modes of QoS are available in these offerings to provide maximum flexibility.

### Max/Priority

This QoS mode allows the assignment of a maximum bandwidth per defined traffic flow and a prioritization level of 1 through 8.

### Min/Max

This QoS mode allows the assignment of both a minimum and a maximum bandwidth per defined traffic flow. From a configuration standpoint, setting the minimum specification for user-defined classes of traffic ensures that a certain level of bandwidth is always applied to given flows.

### DiffServ

DiffServ, an industry-standard method of adding QoS to IP networks, offers the capability to prioritize certain types of traffic and various methods of traffic handling based on the class of a particular stream. As a standards-based approach to QoS, the DiffServ mode ensures that these offerings can seamlessly

co-exist in networks that already have DiffServ deployed. QoS is an optional feature that can be activated via the purchase of the FAST feature.

## HEADER COMPRESSION

Header Compression is an optional feature that can be activated via the purchase of the FAST feature. Compression for the following Ethernet and Layer 3 and 4 Headers is provided:

Supported Ethernet Headers	Supported Layer 3 & 4 Headers
Ethernet 2.0	IP
Ethernet 2.0 + VLAN-tag	TCP
Ethernet 2.0 + MPLS	UDP
802.3-raw	RTP (Codec Independent)
802.3-raw + VLAN-tag	
802.3 + 802.2	
802.3 + 802.2 + VLAN-tag	
802.3 + 802.2 + SNAP	
802.3 + 802.2 + SNAP + VLAN-tag	
802.3 + 802.2 + SNAP + MPLS	

Deploying this feature is simple and operation is independent of QoS, with configuration on a per route basis, as well as enabled/disabled for the overall system. Header Compression reduces the required Voice over IP bandwidth significantly. For example, a G.729a voice codec, operating at 8 kbps, will occupy 29.6 kbps once encapsulated into IP framing on a Local Area Network (LAN). Using IP/UDP/RTP Header Compression, the same traffic only needs 10.8 kbps total Wide Area Network (WAN) satellite bandwidth to cross the link. If the voice codec is equipped with silence suppression, the bandwidth requirement can be reduced another 40% to 60%. A total maximum of 64 simultaneous Voice over IP calls can be compressed. Normal Web/HTTP traffic can be reduced an additional 10% via IP/TCP header compression. The user interfaces also provides statistics to display the total bytes of the pre-compressed and post-compressed traffic and effective compression ratio.

## PAYLOAD COMPRESSION

Advanced Lossless Data Compression (ALDC) applied to the payload (data) condenses the size of data frames, reducing the satellite bandwidth required to transmit across the link. These offerings support Payload Compression using the ALDC compression algorithm, which can provide bandwidth savings in excess of 40%. The compression ratio achieved will be dependent upon both the data content and the average IP packet size.

The ALDC algorithm's performance uses the two most widely used benchmark file sets:

Algorithm	IP Payload Size	File Set Corpus	Ratio
ALDC	1472	Calgary	1.76
	1000		1.76
	500		1.77
	100		2.09
	1472	Canterbury	1.71
	1000		1.72
	500		1.74
	100		2.04

Payload Compression can be activated via the purchase of the FAST feature, and is configurable on a per route basis as well as enabled/disabled for the overall system. Additionally, there are statistics that report the achieved level of compression.

Header Compression can be used with Payload Compression for maximum bandwidth optimization.

### LINK LAYER DATA ENCRYPTION

Optional 3xDES-128 data encryption (using National Institute of Standards and Technology (NIST) certified 3x core) is provided to prevent unauthorized access to data over the satellite link, and is configurable on a per route basis. Encryption is performed as the last processing step on the IP packet before it is framed and transmitting over the satellite; this allows encryption to co-exist with all other traffic shaping elements (QoS, Header and Datagram compression) for these offerings. On the receiving end, satellite frames are sent through decryption first before re-entering the routing engine. When encryption is applied, all IP packet data (including headers if not compressed) as well as the Cyclic Redundancy Check (CRC) is encrypted. Only CEFD's proprietary framing header is transmitted in the clear.

A static key management policy is used which supports eight independent encryption keys and eight independent decryption keys (16 keys in all). All keys are static and user-configurable. Each flow can be configured for encryption by any one of the eight available keys, or by random selection of one of the eight keys. If random mode is selected, the key used to encrypt each packet of a given flow will be chosen randomly from the eight available keys. The keys themselves are never transmitted over the satellite link; instead, a simple index is embedded in the variable-length, proprietary framing header.

Operators can use third party, NIST-certified dynamic keys generation products to regularly regenerate the keys sets, and then use the product management interfaces to automatically reconfigure the static key tables. The elegance of this design is in its simplicity and flexibility. Operators who need a greater level of data security call use this link layer encryption in parallel with external encryption devices, such as the *turboIP*<sup>®</sup>; however, in this mode, QoS, Header and Datagram Compression become inoperable.

### COMTECH PEP – *turboIP*<sup>®</sup>

With convergence of voice, data and video over satellite becoming more common, some organizations are encountering TCP/IP performance limitations. Typical satellite links exhibit both high latency and bit error rates (impaired links), which can be challenging for the transmission of TCP. With this connection-oriented protocol, a number of factors contribute to performance degradation over impaired links, including:

- The time required for an acknowledgement can severely limit the ramp-up in transmission rate
- Sender's small window size reduces throughput
- Delay that is interpreted as network congestion versus propagation causes reduced transmission rates
- Packet loss that is interpreted as network congestion versus corruption causes reduced transmission rates

*turboIP*<sup>®</sup>, CEFD's PEP device, was designed to combat the inherent challenges of transmitting TCP over satellite links. *turboIP*<sup>®</sup> provides transparent acceleration of TCP sessions, or the increase in throughput, over satellite links while requiring minimal topology changes.



Being standards-based – supporting the Space Communications Protocol Standard (SCPS) Transport Protocol (SCPS-TP) – *turboIP*<sup>®</sup> provides reliable connection-oriented, end-to-end data transfer for user applications. It also overcomes the deficiencies that exist with TCP, including slow start and congestion control.

Since it interoperates with TCP/IP networks and devices, *turboIP*® can be seamlessly integrated into existing networks in a staged manner, avoiding the need for network-wide upgrades. *turboIP*® supports the following Open Standards:

- SCPS-TP – May 1999
- ISO standard (15893)
- CC SDS standard (714.0-B-1)
- MIL-STD (MIL-STD-2045-44000)
- RFCs 768, 793, 1122 & 1323

Figure 4 illustrates the advantage of using *turboIP*® to accelerate TCP performance. The results charted are for a single session file transfer over a 10 Mbps full duplex link on a Microsoft Windows 2000™ Professional FTP server and client with factory default TCP settings.

The *turboIP*®, available in a 1RU platform, is deployed in government and military agencies as well as commercial environments around the globe. *turboIP*® is rated to 15 Mbps maximum aggregate throughput and 500 simultaneous TCP sessions.

**DATA AND HEADER COMPRESSION**

In addition to the header compression and payload compression offered by the IP module of the CEFD modems, data and header compression functionality can be made applicable to accelerated TCP traffic.

Compression is enabled/disabled on a session-by-session basis. The compressibility of each segment payload is evaluated individually, and only those payloads where the impacts would be beneficial are compressed.

Enabling data and header compression on *turboIP*® can reduce both bandwidth and transmission time over wide area network links. If disabled, no sessions are compressed.

**SELECTIVE ACCELERATION**

This powerful feature provides a method for QoS for IP version 4 (IPv4) datagrams that are received on the LAN interface and forwarded to the WAN interface. Rules are established to control the processing, including acceleration, compression and filtering for all IP packets. Up to 255 rules can be established. Rule parameters can include source and destination IP address and mask, protocol (TCP, UDP or any), and TCP or UDP source and destination ports. Each rule is assigned a prioritization level of 1 through 8 plus a maximum data rate.

**easyCONNECT™**

The *turboIP*® provides a content-aware, smart bridging design referred to as easyConnect™. The use of easyConnect™ allows seamless integration of the *turboIP*® into existing links without impacting non-TCP traffic. Installation is simplified, since this device looks like a bridge and thus does not require additional subnets. Additionally, all IP multicast and non-IP traffic is forwarded.

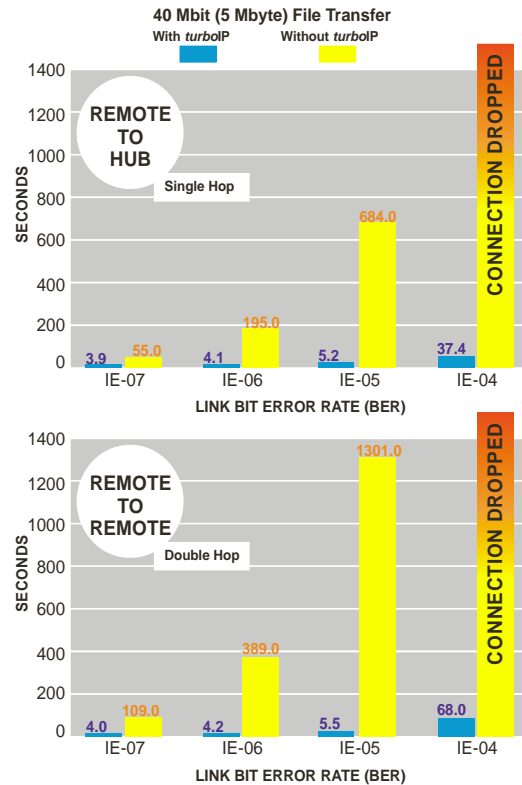

Figure 4. The *turboIP*® Advantage

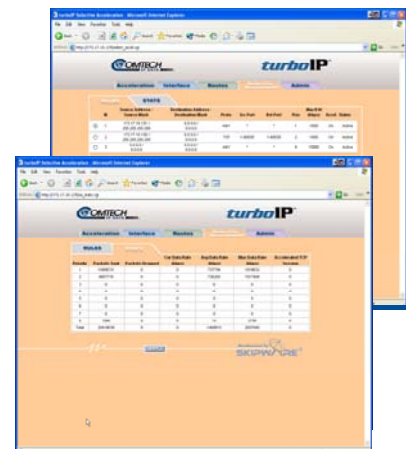

Figure 5. Selective Acceleration Configuration Web Pages

## **SIMPLE NETWORK MANAGEMENT PROTOCOL (SNMP) SUPPORT**

SNMP is a widely used network monitoring and control protocol. *turboIP*<sup>®</sup> supports SNMP versions 1, 2 and 3 to enable network monitoring and control functions, including:

- Access Control
- Security Access Control
- Read/write capabilities for any configuration parameter

This expanded support offers greater security and flexibility to accommodate virtually any network environment deploying SNMP.

## **VIPERSAT MANAGEMENT SYSTEM (VMS)**

The VMS provides network and capacity management of satellite transmission systems through the on-demand allocation of dynamic SCPC (dSCPC) links. The Vipersat platform uses the VMS and CEFD's high performance IP modems to provide a seamless IP-based infrastructure for satellite networking. This advanced system automates bandwidth utilization while optimizing space segment efficiency. The VMS is scalable, designed to anticipate and accommodate future growth, and is capable of managing networks of any size.

Beyond just standard monitor and control (M&C) functions, the VMS provides advanced bandwidth management capabilities, automatic shared-to-dedicated inbound channel switching and sizing based on channel load or application. Single Hop On Demand (SHOD) and Multi-Transponder Mode (MTM) features of the VMS enable efficient space segment usage. Dedicated SCPC circuits can also be automatically scheduled using the Vipersat Circuit Scheduler (VCS).

## **GRAPHICAL USER INTERFACE**

The graphical user interface of the VMS enables centralized network configuration and management. It provides auto-detection of satellite modems, configuration and monitoring of the modems, real-time views of network health and transmission quality, and allows operators to easily modify devices while automatically initiating network performance enhancements. The VMS continues to execute its functions as the network configuration is changed and new remote sites are added.

## **AUTOMATED CAPACITY MANAGEMENT**

The VMS platform design has been driven towards an automated capacity manager with focus on supporting higher-level multimedia applications. This allows VMS to serve a variety of markets and allow for partial Mesh or dynamic SCPC networks, or a combination of both to support the end customers needs.

The VMS network solution automates bandwidth allocation and control to eliminate the need for manual intervention when responding to users' changes (traffic) in bandwidth needs. The network is managed intelligently based upon client-defined rules, resulting in optimization of space segment usage and lower transmission costs.

## **BANDWIDTH ALLOCATION VIA SELECTIVE TIME DIVISION MULTIPLE ACCESS (STDMA)**

The addition of STDMA capability to a network allows multiple terminals to share the same satellite resources that would otherwise be dedicated to a single terminal in an SCPC configuration. This means that more terminals can be added to the network with minimal additional cost in either satellite bandwidth or hub terminal hardware. STDMA provides the availability of a switched pool of SCPC channels for occasional high bandwidth traffic such as videoconferences and large file transfers. The overall network topology can consist of anywhere from one to several hundred remote terminals, which are managed from a central hub terminal with the VMS.

Each STDMA upstream channel uses an STDMA frame operating at an aggregate data rate from 64 kbps to 6.75 Mbps and can support upwards of 100 remote terminals. Multiple upstream channels can be utilized if required. To achieve scalability for larger networks, the system allows multiple STDMA channels

to operate simultaneously at the hub, and each STDMA controller can operate independently from the VMS to ensure continuous communications in the event of a network server failure.

The dSCPC functionality takes advantage of the fast acquisition demodulator technology inherent in CEFD's family of IP modem products. The role of these modems is defined in software configuration. The hardware for the Time Division Multiplexed (TDM) outbound, burst controllers, switched and SHOD demodulators is functionally identical. Any of CEFD's IP modem products can be configured as a hub or remote, yielding improved logistics (sparing, ordering, inventory), training and re-deployment to other or new sites.

### **STAR AND MESH NETWORK TOPOLOGIES**

The VMS provides multiple access methods and topologies within the same network, using the same hub and remote equipment. This solution allows STDMA, SCPC, and mesh connectivity simultaneously on the same network.

With SHOD, the VMS provides a cost-effective way to mesh remotes for latency sensitive traffic such as voice or video conferencing. At all times, a remote is in single carrier operation, which allows significant cost savings over a fully meshed static SCPC network. Additionally, the VMS provides automatic upstream switching to SCPC based on application detection (voice, video), QoS rules and traffic loading. Manual and scheduled switching is also provided. With L-band modems, VMS provides the ability to switch across entire satellites using MTM.

### **INTEGRATION INTO EXISTING DIGITAL VIDEO BROADCAST (DVB) NETWORKS**

Vipersat fits seamlessly into networks with DVB outbound functionality. This flexibility allows existing 'receive only' networks to expand to 'interactive' networks without replacing expensive hub hardware. Customers who have a mix of 'receive only' and interactive sites will be able to continue using their DVB platform as their outbound for the interactive sites. It also allows a hybrid DVB/Vipersat network to scale much larger outbound throughputs.

### **AUTOMATIC CIRCUIT SCHEDULING**

The Vipersat solution provides users with the ability to automatically schedule and set up ad hoc SCPC connections. Circuits can be scheduled via a web-based interface by date/time, circuit type, participating nodes or bandwidth. The VCS simplifies the network setup process and enables bandwidth-sharing capacity for a variety of applications.

### III. COMTECH EF DATA IP NETWORK SOLUTIONS CASE STUDY

In order to adequately evaluate the flexibility, efficiency and security of a Comtech EF Data-equipped satellite-based IP network, a relatively simple application will be closely examined. In this case study, CEFD analyzes the equipment cost, bandwidth cost and maintenance cost to field a satellite-based corporate network between the corporate headquarters and five remote sites.

#### NETWORK REQUIREMENTS

The network requirements for this case study will combine voice components (Video over IP, or VoIP) between the headquarters and all five remote sites, interactive video components for videoconferencing between the headquarters and two of the largest remote sites, and data components for all remotes (file transfer, e-mail and Internet access).

#### VOICE REQUIREMENTS

The headquarters' voice requirements are to support 60 VoIP phones managed by a locally installed Cisco Call Manager/Server. Two of the remote sites are regional distribution centers with voice requirements of 20 VoIP phones each. The remaining three remote sites are small dispatch centers with requirements for 5 VoIP phones.

#### VIDEO REQUIREMENTS

The headquarters and two regional distribution centers all need to be equipped with video conferencing equipment to support both two-way and three-way daily sales, scheduling, procurement and planning meetings.

#### DATA REQUIREMENTS

The corporate intranet will be managed and served from the headquarters site. The intranet will provide a number of services used by all five remote sites, including employee time tracking and reporting for payroll purposes, corporate ERP system access, and configuration management and business standards applications. Additionally, high-speed access to the Internet will be provided to all five remote sites via the T1 link at the headquarters.

### COMTECH EF DATA IP NETWORK SOLUTIONS CASE STUDY - IMPLEMENTATION No. 1

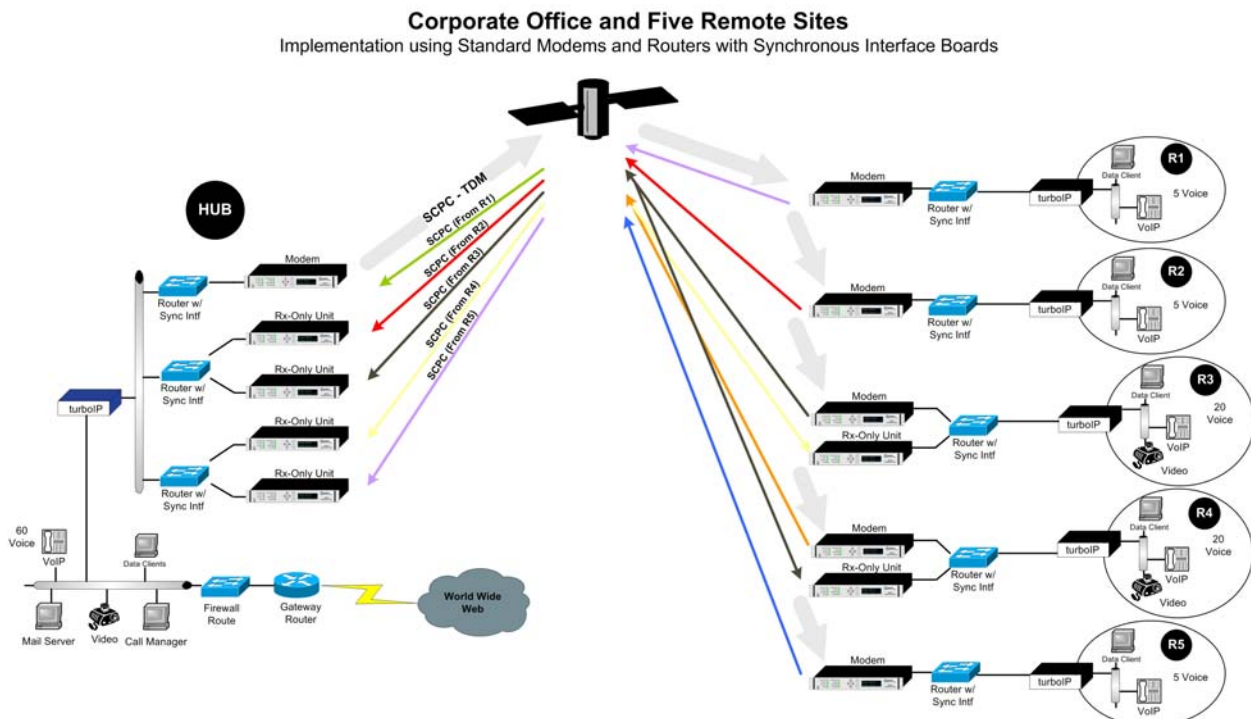

The preceding figure illustrates CEFD's first proposed satellite network implementation that meets the previously defined network requirements. This network represents the legacy implementation that uses standard satellite modems coupled with a router equipped with synchronous data interfaces.

For this study, it is assumed that each network router can support two synchronous interface cards. A classic hub and spoke architecture is used, with a large TDM outbound carrier common for all five remote sites. The network routers using IP addressing and masks perform data filtering at the five remote sites. Smaller return channels are used from the remote sites to the headquarters site. Additionally, the two distribution centers – remotes 2 and 3 – are equipped with a second, receive-only modem to support the site-to-site videoconferencing requirement.

In order to support the requirement for high speed Internet service to the remote sites, a *turboIP*<sup>®</sup> is installed at the headquarters and at each of the remote sites.

## EQUIPMENT TALLY

This study examines only the differing equipment between the three sample implementations; i.e., the delta equipment cost. Implementation No. 1 requires the following delta equipment:

- 8 network routers
- 12 synchronous interface boards
- 6 duplex satellite modems
- 6 receive-only satellite modems

The following costs are assumed: \$3500 per duplex modem; \$2450 per receive-only modem; \$1900 per network router; and \$250 per synchronous interface board. The equipment cost for this implementation is then:

Network routers:	$\$1900 \times 8 = \$15,200$
Synchronous interfaces:	$\$250 \times 12 = \$3,000$
Duplex modems:	$\$3500 \times 6 = \$21,000$
Receive-only modems:	$\$2450 \times 6 = \$14,700$

Total Equipment Cost = **\$53,900**

## HUB OUTBOUND SATELLITE BANDWIDTH REQUIREMENTS

The bandwidth requirements at the hub are driven primarily by the VoIP, Video and Internet requirements:

- **VoIP** – G.729a Codec, 8 kbps, 50 packets/second. Each IP packet consists of: 8 bytes of layer 2 header (depending upon your HDLC configuration); 20 byte IP header; 8 byte UDP header; 12 byte RTP header; and 20 bytes of voice data. Total packet size is 68 bytes. Therefore, each VoIP call requires 27.2 kbps satellite bandwidth. (Note: For simplicity, it is assumed that the bandwidth required for Call setup, keep alive, and tear down is negligible.)  
**60 VoIP** –  $60 \times 27.2 \text{ kbps} = \mathbf{1632 \text{ kbps}}$
- **Video** – **380 kbps**
- **Internet T1** – **1544 kbps**

The total Hub Outbound bandwidth requirement is therefore sized at  $1632 + 380 + 1544 = \mathbf{3556 \text{ kbps}}$ .

## DISTRIBUTION CENTER OUTBOUND SATELLITE BANDWIDTH REQUIREMENTS

The bandwidth requirements at remotes 2 and 3 are driven primarily by VoIP, video and Internet requirements:

- **20 VoIP** –  $20 \times 27.2 \text{ kbps} = \mathbf{544 \text{ kbps}}$
- **Video** – **380 kbps**
- **Internet T1** – **772 kbps** (1/2 T1)

The total outbound bandwidth requirement for each of these two remotes is therefore sized at  $544 + 380 + 772 = 1696$  kbps.

### DISPATCH CENTER OUTBOUND SATELLITE BANDWIDTH REQUIREMENTS

The bandwidth requirements at remotes 1, 4 and 5 are driven primarily by the VoIP and Internet requirements:

- **5 VoIP** –  $5 \times 27.2$  kbps = **136 kbps**
- **Internet T1** – **386 kbps** (1/4 T1)

The total outbound bandwidth requirement for each of these three remotes is therefore sized at  $136 + 386 = 522$  kbps.

### SATELLITE BANDWIDTH COST

The total Satellite bandwidth requirements for this implementation, assuming QPSK modulation, turbo rate  $\frac{3}{4}$  FEC and a channel space of 1.25 would be:

Hub Site:	3556 kbps = 2370 ksym/sec
Remote 1:	522 kbps = 348 ksym/sec
Remote 2:	1696 kbps = 1130 ksym/sec
Remote 3:	1696 kbps = 1130 ksym/sec
Remote 4:	522 kbps = 348 ksym/sec
Remote 5:	522 kbps = 348 ksym/sec

Total Satellite bandwidth = **5.674 MHz**

For this study, a flat cost of \$4000 per month per 1 MHz is assumed. Therefore, the yearly bandwidth cost would be:

$5.674 \text{ MHz} \times \$4000/\text{Mbps/month} \times 12 \text{ months} = \mathbf{\$272,352 \text{ per year}}$

### COMTECH EF DATA IP NETWORK SOLUTIONS CASE STUDY - IMPLEMENTATION No. 2

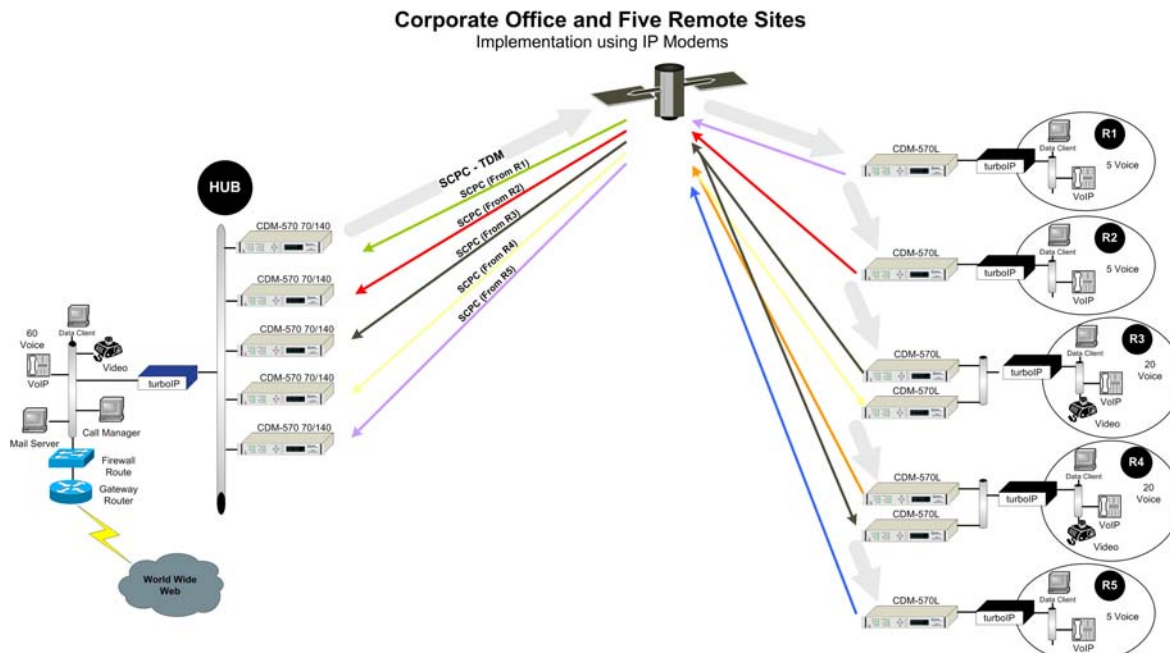

The preceding figure illustrates CEFD's second implementation of the satellite network that meets the previously defined network requirements. This network implements the use of CEFD IP-enabled duplex modems.

A classic hub and spoke architecture is used, with a large TDM outbound carrier common for all five remote sites. Data filtering at the five remote sites is performed directly by the IP modem using IP addressing and masks. Smaller return channels are used from the remote sites to the headquarters site.

Additionally, the two distribution centers – remotes 2 and 3 – are equipped with a second duplex modem to support the site-to-site video-conferencing requirement. This implementation will make use of both IP header compression and datagram compression.

## EQUIPMENT TALLY

This study examines only the differing equipment between the three sample implementations; i.e., the delta equipment cost. Implementation No. 2 requires 12 duplex satellite modems as its delta equipment.

The following cost is assumed: \$5500 per duplex IP modem with all Options Enabled (\$4000 base + \$1500 Options). The equipment cost for this implementation is then:

Duplex IP Modems:      \$5500 x 12 = \$66,000

Total Equipment Cost = **\$66,000**

## HUB OUTBOUND SATELLITE BANDWIDTH REQUIREMENTS

The bandwidth requirements at the hub are driven primarily by the VoIP, Video and Internet requirements:

- **VoIP** – G.729a Codec, 8 kbps, 50 packets/second. Total packet size on the LAN before header compression is 74 bytes. Total packet size after header compression is 27 bytes. Therefore, each VoIP call requires 10.8 kbps satellite bandwidth.  
**60 VoIP** – 60 x 10.8 kbps = **648 kbps**
- **Video** – **380 kbps** (uncompressible)
- **Internet T1** – 1544 kbps compressed at an average of 40% requires **926 kbps**

The total hub outbound bandwidth requirement is therefore sized at 648 + 380 + 926 = **1954 kbps**.

## DISTRIBUTION CENTER OUTBOUND SATELLITE BANDWIDTH REQUIREMENTS

The bandwidth requirements at remotes 2 and 3 are driven primarily by the VoIP, Video and Internet requirements:

- **20 VoIP** – 20 x 10.8 kbps = **216 kbps**
- **Video** – **380 kbps** (uncompressible)
- **Internet T1** – 772 kbps (1/2 T1) compressed at an average of 40% requires **463 kbps**

The total outbound bandwidth requirement for each of these two remotes is therefore sized at 216 + 380 + 463 = **1059 kbps**.

## DISPATCH CENTER OUTBOUND SATELLITE BANDWIDTH REQUIREMENTS

The bandwidth requirements at remotes 1, 4 and 5 are driven primarily by the VoIP and Internet requirements:

- **5 VoIP** – 5 x 10.8 kbps = **54 kbps**
- **Internet T1** – 386 kbps (1/4 T1) compressed at an average of 40% requires **232 kbps**

The total outbound bandwidth requirement for each of these three remotes is therefore sized at 54 + 232 = **286 kbps**.

## SATELLITE BANDWIDTH COST

The total Satellite bandwidth requirements for this implementation, assuming QPSK modulation, turbo rate 3/4 FEC and a channel space of 1.25, would be:

Hub Site:	1954 kbps = 1302 ksym/sec
Remote 1:	286 kbps = 191 ksym/sec
Remote 2:	1059 kbps = 706 ksym/sec
Remote 3:	1059 kbps = 706 ksym/sec
Remote 4:	286 kbps = 191 ksym/sec
Remote 5:	286 kbps = 191 ksym/sec

Total Satellite bandwidth = **3.287 MHz**

3.287 MHz x \$4000/Mbps/month x 12 months = **\$157,776 per year**

CEFD's IP modems also support 8-PSK and 16-QAM modulations. The total satellite bandwidth, if each of these modulation types is used with turbo rate  $\frac{3}{4}$  FEC, would be:

- 8-PSK Total Satellite bandwidth = 2.191 MHz, **\$105,173 per year**
- 16-QAM Total Satellite bandwidth = 1.643 MHz, **\$78,880 per year**

### COMTECH EF DATA IP NETWORK SOLUTIONS CASE STUDY - IMPLEMENTATION No. 3

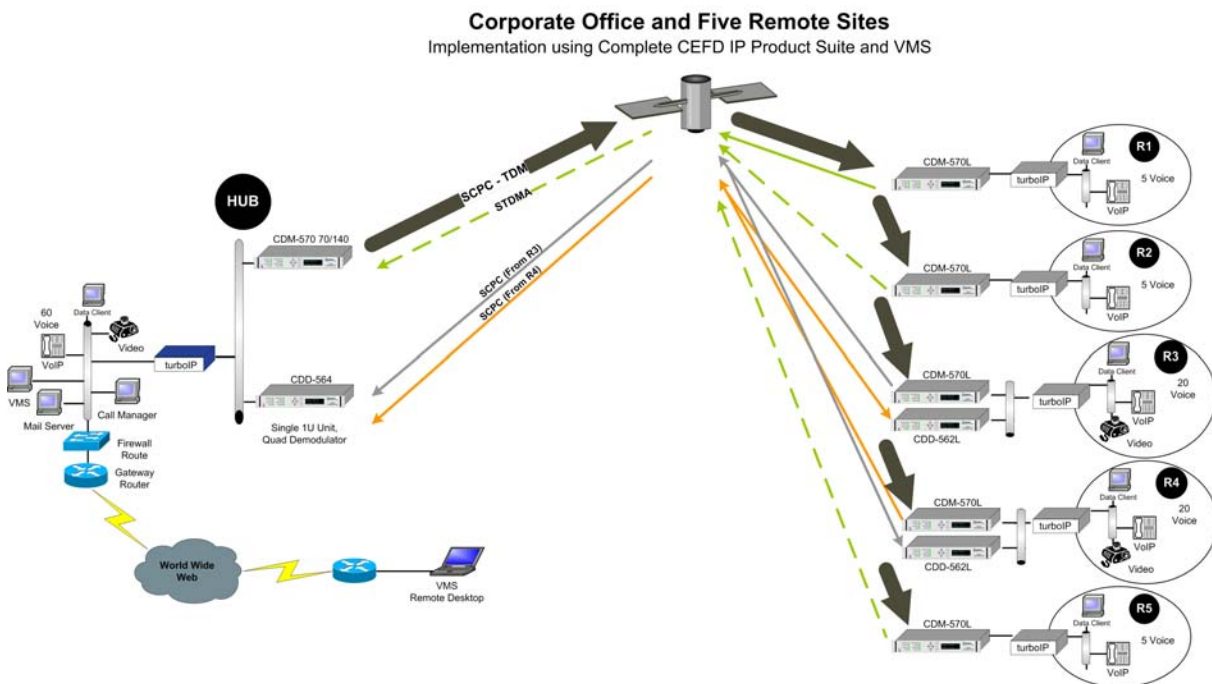

The preceding figure illustrates CEFD's final proposed satellite network implementation that meets the previously defined network requirements. This network implements complete use of CEFD IP-enabled modem products and the Comtech Vipersat VMS system.

A modified hub and spoke architecture is used with a large TDM outbound carrier common for all five remote sites. Data filtering at the five remote sites is performed directly by the IP modem using IP addressing and masks. A shared smaller return channel is used from the remote sites to the headquarters site. During periods of video conferencing the two distribution centers – remotes 2 and 3 – are automatically removed from the STDMA cycle and provided dedicated SCPC channels.

Due to the benefits of shared bandwidth, less bandwidth can be reserved due to the assumption that all calls will not be simultaneously ongoing. For the purposes of this paper, it is assumed that the one third of the available bandwidth will be active at any given time.

### EQUIPMENT TALLY

This study examines only the differing equipment between the three sample implementations; i.e., the delta equipment cost. Implementation No. 3 requires the following delta equipment:

- 6 duplex satellite modems
- 1 CDD-564 Quad Demodulator
- 2 CDM-562L Dual Demodulators

The following costs are assumed: \$5500 per duplex IP modem with Options; \$6000 per CDD-564 Quad Demodulator; and \$4300 per CDM-562L Dual Demodulator with Options. The equipment cost for this implementation is then:

Duplex IP modems:	\$5500 x 6 = \$33,000
CDD-564:	\$6000 x 1 = \$6,000
CDM-562L w/Options:	\$4300 x 2 = \$8,600

Total Equipment cost = **\$47,600 + VMS cost**

### HUB OUTBOUND SATELLITE BANDWIDTH REQUIREMENTS

The bandwidth requirements at the hub remain the same as the previous implementation:  
**1954 kbps.**

### DISTRIBUTION CENTER OUTBOUND SATELLITE BANDWIDTH REQUIREMENTS

The return channel from remotes 2 and 3 will normally be part of the shared STDMA channel and will be switched to SCPC operation when voice and/or video requirements exist:

- **Internet T1** – Normally Shared return channel sized at 772 kbps (1/2 T1) compressed at an average of 40% requires **463 kbps**. When switched to SCPC, **463 kbps** will be allocated.

The worst-case total non-Voice/Video outbound bandwidth requirement for each of these two remotes is therefore sized at **463 kbps**.

### DISPATCH CENTER OUTBOUND SATELLITE BANDWIDTH REQUIREMENTS

The return channel from remotes 1, 4 and 5 will normally be part of the shared STDMA channel and will be switched to SCPC operation when voice and/or video requirements exist:

- **Internet T1** – Normally Shared return channel sized at 386 kbps (1/4 T1) compressed at an average of 40% requires **232 kbps**. As shared over the STDMA channel, when switched to SCPC **232 kbps** will be allocated.

The worst-case total outbound bandwidth requirement for each of these three remotes is therefore sized at **232 kbps**.

### STDMA RETURN CHANNEL COST

In order to maintain communication as well as low throughput communications, a small Entry Channel STDMA channel will be provisioned. The appropriate channel in this case is **64 kbps**.

## SHARED VOICE AND VIDEO POOLED BANDWIDTH COST

Because the Vipersat VMS allows for bandwidth on demand, a 3-to-1 concentration for voice and a 2-to-1 concentration for video is used to handle the on-demand back channel requirements:

- **25/3 = 8 VoIP** – 8 x 10.8 kbps = **86.4 kbps**
- **2/1 = 1 Video** – **380 kbps** (uncompressible)

The total on-demand bandwidth pool size will be: **467 kbps**.

## SATELLITE BANDWIDTH COST

The total Satellite bandwidth requirements for this implementation, assuming QPSK modulation, turbo rate  $\frac{3}{4}$  FEC and a channel space of 1.25 would be:

Hub Site: 1954 kbps = 1302 ksym/sec  
 STDMA Return: 64 kbps = 43 ksym/sec  
 On-Demand Pool: 467 kbps = 312 ksym/sec  
 Remote 1: 232 kbps = 155 ksym/sec  
 Remote 2: 463 kbps = 309 ksym/sec  
 Remote 3: 463 kbps = 309 ksym/sec  
 Remote 4: 232 kbps = 155 ksym/sec  
 Remote 5: 232 kbps = 155 ksym/sec

Total Satellite bandwidth = **2.740 MHz**

2.740 MHz x \$4000/Mbps/month x 12 months = **\$131,520 per year**

CEFD's IP modems also support 8-PSK and 16-QAM modulations. Therefore, total satellite bandwidth, if each of these modulation types is used with turbo rate  $\frac{3}{4}$  FEC, would be:

- 8-PSK Total Satellite bandwidth = 1.825.33 MHz, **\$87,616 per year**
- 16-QAM Total Satellite bandwidth = 1.369 MHz, **\$65,712 per year**

## COMTECH EF DATA IP NETWORK SOLUTIONS CASE STUDY - SUMMARY OF RESULTS

Case No.	Description	Equipment Cost <sup>1</sup>	Equipment Cost Savings	Satellite Bandwidth Cost / Year	Satellite Bandwidth Cost Saving	Total Savings
1	Baseline –Traditional standard modem and router topology	\$53,900	----	\$272,352	----	----
2	Duplex IP Modems	\$66,000	(\$12,100)	QPSK: \$157,776 8PSK: \$105,173 16QAM: \$78,880	\$114,576 \$167,179 \$193,472	\$102,476 \$155,079 \$181,372
3	Complete CEFD IP modem Products Suite Plus VMS	\$47,600 <sup>2</sup>	\$6,300 <sup>2</sup>	QPSK: \$131,520 8PSK: \$87,616 16QAM: \$65,712	\$140,832 \$184,736 \$206,640	\$147,132 \$191,036 \$212,940

Notes: 1 – Only includes cost of equipment that is NOT common to all three implementations.

2 – Does not include cost of VMS licensing; this will scale depending upon network size.

## CONCLUSION

The rapid growth of IP networks, products and services, fueled over the past two decades by the phenomenal explosion of the World Wide Web, has dramatically changed the content of data over geosynchronous satellite networks worldwide.

Comtech EF Data products combine the best modulation and Forward Error Correction with powerful built-in IP routing and data conditioning features, providing cost-effective, flexible bandwidth and efficient and secure solutions to meet today's requirements and tomorrow's unknowns.



---

## ADDITIONAL RESOURCES

Related White Papers from the Comtech EF Data Web site:

- [“Implementing a Voice over IP Network Using Comtech EF Data IP-Enabled Satellite Modems”](#)

---

Please contact Comtech EF Data Sales for more information about this innovative technology.

**Voice: 480.333.2200**

**Fax: 480.333.2540**

**Email: [sales@comtechefdata.com](mailto:sales@comtechefdata.com)**

**On the Web: <http://www.comtechefdata.com/>**