



Title Box:

- Station Type: _____
- Station Location: _____
- Equipment Rack's Configuration Revision: _____
- Data of Last Revision: _____
- Project Title: _____
- End User: _____



Rack Installation Operator's Guide



Rack Installation Operator's Guide

Part Number MN/MID-RACK.IOM

Revision 1
March 25, 2002

Comtech EF Data is an ISO 9001
Registered Company.



Copyright Comtech EFData, 2002. All rights reserved. Printed in USA.
Comtech EF Data, 2114 West 7th Street, Tempe, Arizona 85281 USA, 480.333.2200, FAX: 480.333.2161

Network Customer Support

The Network Customer Support Plan identifies the steps to be followed in resolving the Customer's concern.

The resolution efforts will follow these levels of contact:

- **Level One Contact** – Factory Authorized Service Center.
- **Level Two Contact** – Comtech EF Data Customer Support.
- **Level Three Contact** – Network Test and Field Support

Procedural Steps

Step	Procedure
1	The Customer raises a concern with the Level One Contact .
2	The Level One Contact will perform Hardware repairs and Network Operations troubleshooting in accordance with the Comtech EF Data Service Center agreement.
3	If the Level One Contact is unable to resolve the concern, then the Level One Contact will inform the Level Two Contact of the concern in accordance with the instructions found within the attached Comtech EF Data Customer Support Department's document.
4	The Level Two Contact will enter the concern into the Comtech EF Data database and determine whether the concern is a Hardware concern or a Network Operations concern
5	The Level Two Contact will interface with the Level One Contact and provide the appropriate hardware support and enter all correspondence into the Comtech EF Data database.
6	If the Level Two Contact determines that the concern is a Network Operations concern, then the Level Two Contact will inform the Level Three Contact .
7	The Level Three Contact will interface with the Level One Contact and provide the appropriate support and enter all correspondence into the Comtech EF Data database.
8	If the Level Three Contact determines that there is a Hardware failure then the Level Three Contact will inform the Level Two Contact . Go to Step 5.

Network Customer Support Plan

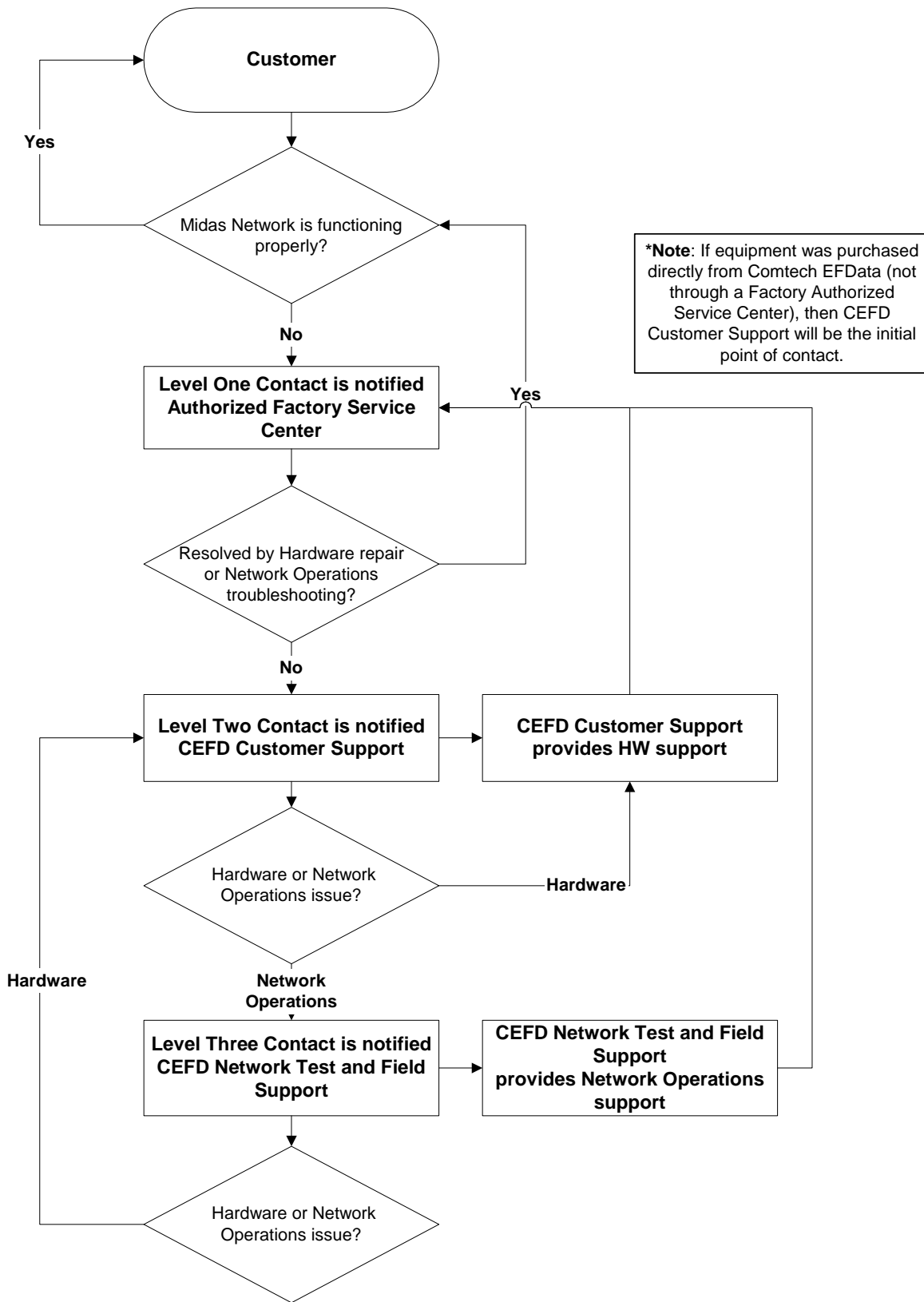

See the Comtech EF Data website at <http://www.comtechefdata.com> for contact information for a Factory Authorized Service Center. Contact the Factory Authorized Service Center for:

- Product support
- Information on upgrading or returning a product

Contact the Comtech EF Data Customer Support Department for:

- Product support or training
- Information on upgrading or returning a product

A Customer Support representative may be reached at:

Comtech EF Data
Attention: Customer Support Department
2114 West 7th Street
Tempe, Arizona 85281 USA

480.333.2200 (Main Comtech EF Data Number)
480.333.4357 (Customer Support Desk)
480.333.2500 FAX

or, E-Mail can be sent to the Customer Support Department at:

service@comtechefdata.com

To return a Comtech EF Data product (in-warranty and out-of-warranty) for repair or replacement:

1. Request a Return Material Authorization (RMA) number from the Comtech EF Data Customer Support Department.
2. Be prepared to supply the Customer Support representative with the model number, serial number, and a description of the problem.
3. To ensure that the product is not damaged during shipping, pack the product in its original shipping carton/packaging.
4. Ship the product back to Comtech EF Data. (Shipping charges should be prepaid.)

Contact the Comtech EF Data Network Test and Field Support

- System level Network Operations support
- Information on upgrading Network Operation software
- Reporting comments or suggestions concerning manuals

A Network Test and Field Support representative may be reached at:

Comtech EF Data
Attention: Network Test and Field Support
2114 West 7th Street
Tempe, Arizona 85281 USA

480.225.2200 (Main Comtech EF Data Number)
480.225.3693 (Network Test and Field Support)
480.333.2161 FAX

or, E-Mail can be sent to the Network Test and Field Support Department at:

<mailto:midasfss@comtechefdata.com>

Contact us via the web at www.comtechefdata.com.

This page is intentionally left blank.

Table of Contents

1. INTRODUCTION.....	1-1
Introduction	1-1
Title Box	1-1
Revision History.....	1-1
Equipment.....	1-2
Equipment Rack Elevation	1-2
Equipment View	1-2
Equipment Rack Wiring Diagram	1-2
2. Equipment View.....	2-1
Equipment View	2-1
CiM-300L	2-3
CiM-550.....	2-4
CDM-550.....	2-5
CDM-600.....	2-6
SDM-300A	2-7
SDM-2020 Modulator	2-8
SDM-2020 Demodulator	2-9
SNM-1000	2-10
SNM-1001	2-11
SNM-1002	2-12
SNM-1010	2-13
SMS-301	2-14
3. Typical Rack Installation	3-1
General	3-1
Required Equipment.....	3-2
Typical Rack Installation.....	3-3
Workstation	3-3
Rack Installation	3-4
Wiring Connections	3-6
Equipment Rack History.....	3-7

This page is intentionally left blank.

About this Manual

This manual provides installation and operation information for Comtech EF Data equipment. This is a technical information guide document intended to provide technicians and operators responsible for the operation and maintenance of the equipment as used in satellite communications equipment with rack installation instructions.

Overview of Changes to Previous Editions

Chapter 2 – Added views for CDM-550, CDM-600, CiM-550, and CiM-300L modems.
Chapter 3 – Added rack instructions.

Conventions and References

Metric Conversion

Comtech EF Data provides metric conversion information located on the inside back cover of this manual. This information is provided to assist the operator in cross-referencing English to Metric conversions, as necessary.

Trademarks

Product names mentioned in this manual may be trademarks or registered trademarks of their respective companies and are hereby acknowledged.

Reporting Comments or Suggestions Concerning this Manual

Comments and suggestions regarding the content and design of this manual will be appreciated. To submit comments, please contact the Comtech EF Data Technical Publications department: techpub@comtechefdata.com

Disclaimer

Comtech EF Data has reviewed this manual thoroughly in order that it will be an easy-to-use guide to your product. All statements, technical information, and recommendations in this manual and in any guides or related documents are believed reliable, but the accuracy and completeness thereof are not guaranteed or warranted, and they are not intended to be, nor should they be understood to be, representations or warranties concerning the products described.

Further, Comtech EF Data reserves the right to make changes in the specifications of the products described in this manual at any time without notice and without obligation to notify any person of such changes.

1. INTRODUCTION

Introduction	1-1
Title Box	1-1
Revision History	1-1
Equipment	1-2

Introduction

The objective of this document is to record the rack location and cable connection of the Comtech EF Data provided equipment.

Scope

A representation of the equipment installed into the rack, equipment front and rear panel views, and wiring diagrams also are included.

- If a station has multiple equipment racks, then multiple documents will be required to record each equipment rack installation (one document per rack).

For the purpose of this manual, the equipment rack is identified as 'Equipment Rack Number 1.'

For installation with multiple equipment racks, the rack identification number shall be incremented.

Title Box

The Title Box shall be modified to identify the required information, as shown on the Cover.

Revision History

A typical 'Revision History' form, shall be maintained by the user to record the following information:

- Revision Number
- Revision Date
- Revision Description
- Documentation Administrator

Equipment

Equipment Rack Elevation

Figure 1-1 illustrates a rack with 44 rack unit locations. This rack table should be reflecting the actual rack units installed in the equipment rack. The RU locations start at the bottom of the rack. The unavailable RU location(s) can be ignored.

Note: All modems are 1RU.

A description of the equipment, such as, the Controller, SNM-1000, or the SDM-300A can be indicated in a cell of the table. A 'Comment' column may be used to specify:

- Node Address
- Data I/O Interface Type
- Data Circuitry functions

Equipment View

Views of the front and rear panels of Comtech EF Data provided equipments are included in Chapter 2 for reference purposes. The rear panel views show the connections required in the Wiring Diagram.

Equipment Rack Wiring Diagram

The Wiring Diagram in Figure 1-2 can be used to record the specifics of interconnections between the units in the rack.

Rack Location	Equipment Rack Number 1 Elevation	Comments
RU 44		
RU 43		
RU 42		
RU 41		
RU 40		
RU 39		
RU 38		
RU 37		
RU 36		
RU 35		
RU 34		
RU 33		
RU 32		
RU 31		
RU 30		
RU 29		
RU 28		
RU 27		
RU 26		
RU 25		
RU 24		
RU 23		
RU 22	SDM300A	Video Conference
RU 21		
RU 20		
RU 19		
RU 18		
RU 17		
RU 16		
RU 15		
RU 14		
RU 13		
RU 12		
RU 11		
RU 10		
RU 9		
RU 8		
RU 7		
RU 6		
RU 5		
RU 4		
RU 3		
RU 2		
RU 1		

Figure 1-1. Equipment Rack

This page is intentionally left blank.

2. Equipment View

Equipment View

The following, but limited to, units are included in this manual for the purpose of showing the front and rear panels. For additional information, refer to the modem installation and operation manual.

Identifiers for various band frequencies are not included and reference shall be made to the individuals installation and operation manual.

Comtech EF Data Equipment	
SNM-1000	Node Control Modem
SNM-1001	Network Control Modem
SDM-1002	LinkSync™ Modem
SNM-1010	Data/Control Modem
SDM-1010L	Data/Control Modem
CiM-300L	IP Enabled Satellite Modem
CiM-550	IP Enabled Satellite Modem
CDM-550	Satellite Modem
CDM-600	Satellite Modem
SDM-300A	Satellite Modem
SDM-2020(M)	Satellite Modulator
SDM-2020(D)	Satellite Demodulator
SMS-301	Redundancy (Protection) Switch

This page is intentionally left blank.

SNM-1000

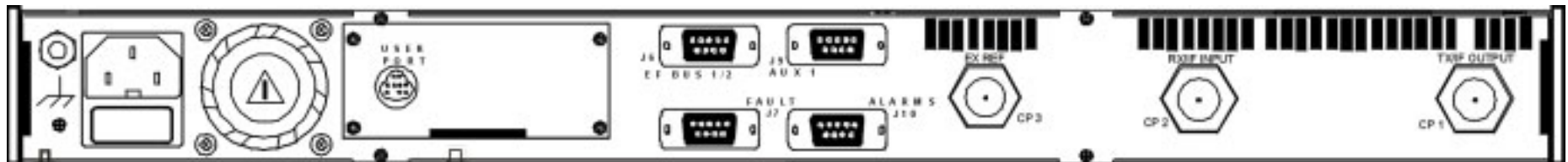

Physical:

1 RU

Size: 1.75H x 19W x 15.7D inches (4.4 x 48 x 40D cm)

Weight: ≤ 9 lbs (≤ 4 kg)

SNM-1001

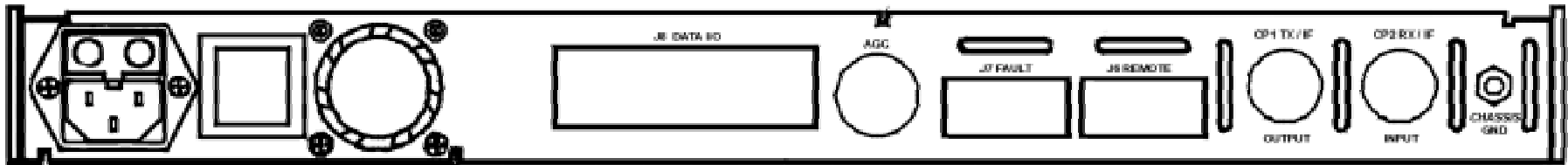
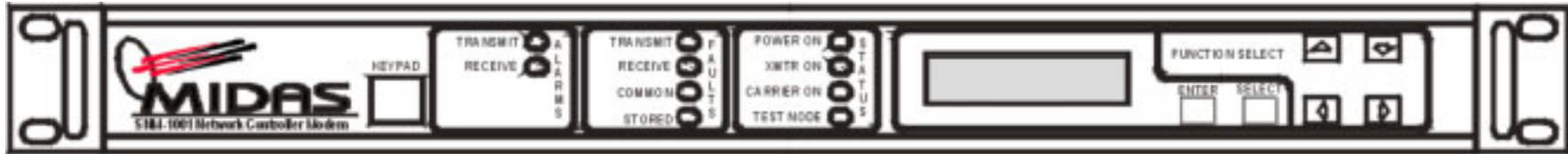

Physical:

1 RU

Size: 1.75H x 19W x 20D inches (4.4 x 48 x 51 cm)

Weight: ≤ 9 lbs (≤ 4 kg)

SNM-1010

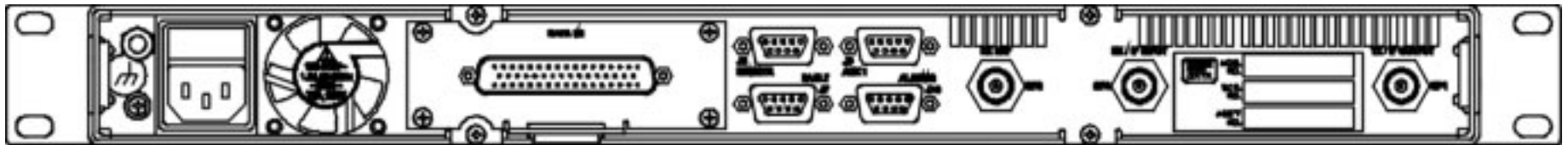

Physical:

1 RU

Size: 1.75H x 19W x 16D inches (4.4 x 48 x 40 cm)

Weight: ≤ 9 lbs (≤ 4 kg)

SNM-1010L

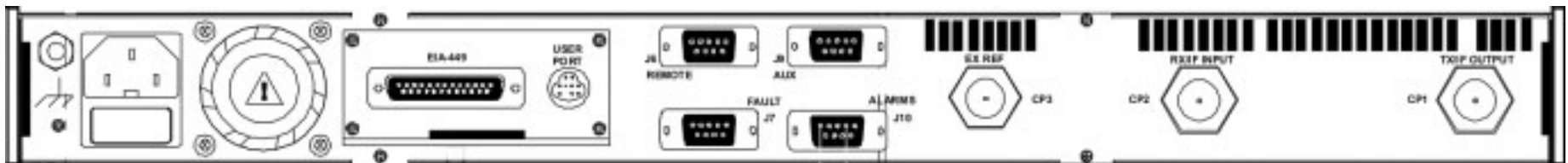
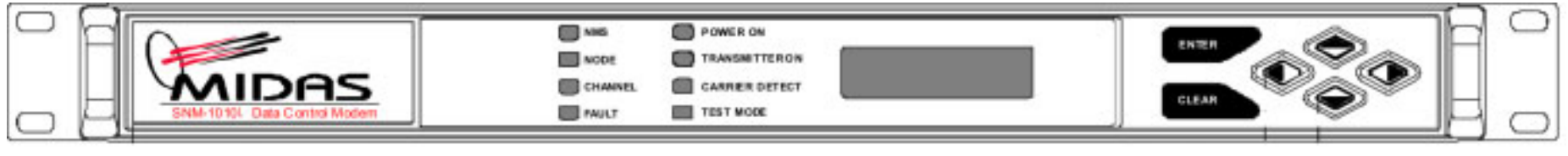

Physical:

1 RU

Size: 1.75H x 19W x 16D inches (4.4 x 48 x 40 cm)

Weight: ≤ 9 lbs (≤ 4 kg)

CiM-550

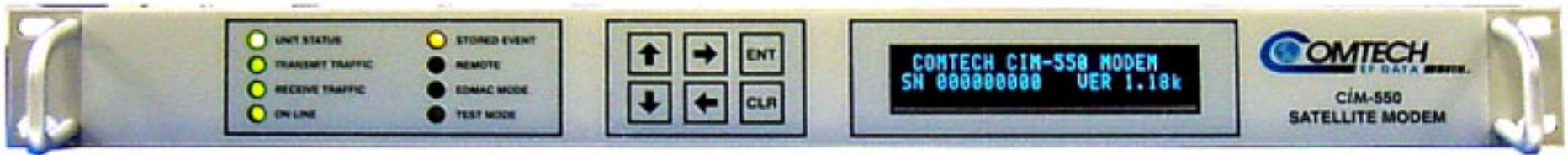

Physical:

1RU

Size: 1.75H x 19.0W x 18.0D inches (4.4 x 48.0 x 46 cm)

Weight: ≤ 9 lbs (≤ 4 kg)

CDM-550

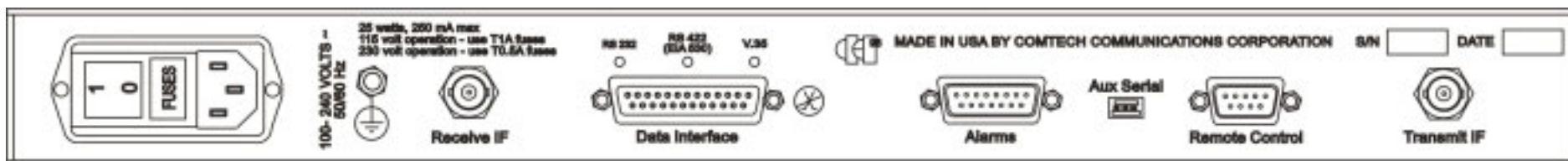

Physical:

1 RU

Size: 1.75H x 19.0W x 18.0D inches (4.4 x 48.0 x 46 cm)

Weight: ≤ 9 lbs (≤4 kg)

CDM-600



Physical:

1 RU

Size: 1.75H x 19.0W x 13.13D inches (4.4 x 48 x 33.3 cm)

Weight: ≤ 9 lbs (≤ 4 kg)

SDM-300A

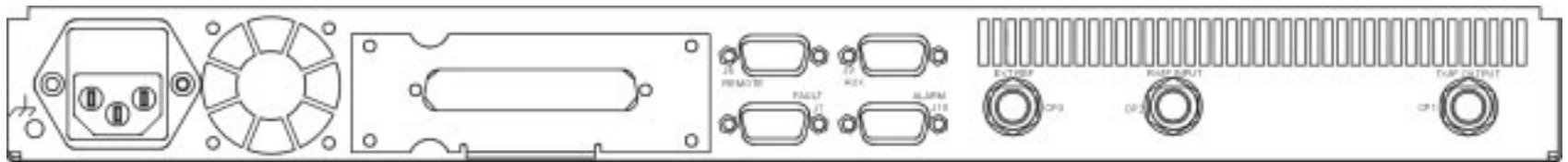
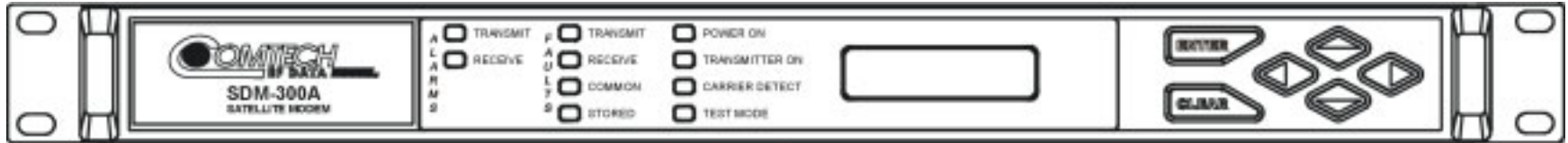

Physical:

1 RU

Size: 1.75H x 19.0W x 14.0 inches (4.4 x 48 x 36 cm)

Weight: 9 lbs (4 kg)

SDM-2020 Modulator

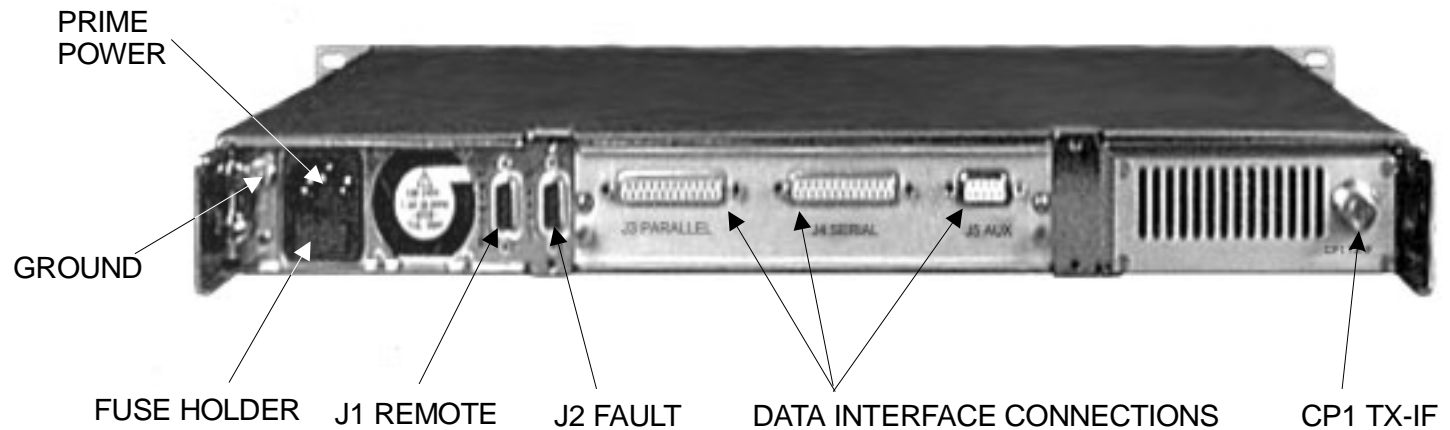
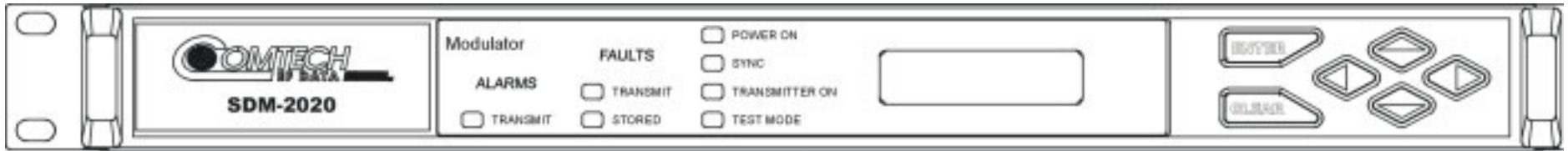

Physical:

1 RU

Size: 1.75 H x 19W x 14D inches (4.4 x 48 x 36 cm)

Weight: < 15 lbs (<7 kg)

SDM-2020 Demodulator

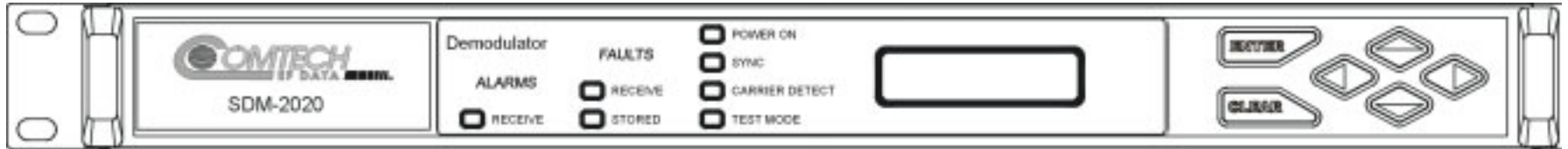

Physical:

1 RU

Size: 1.75H x 48W x 14D inches (4.4 x 48 x 36 cm) Older chassis
1.75H x 48W x 16D inches (4.4 x 48 x 41 cm) New chassis

Weight: ≤ 15 lbs (≤ 7 kg)

SMS-301

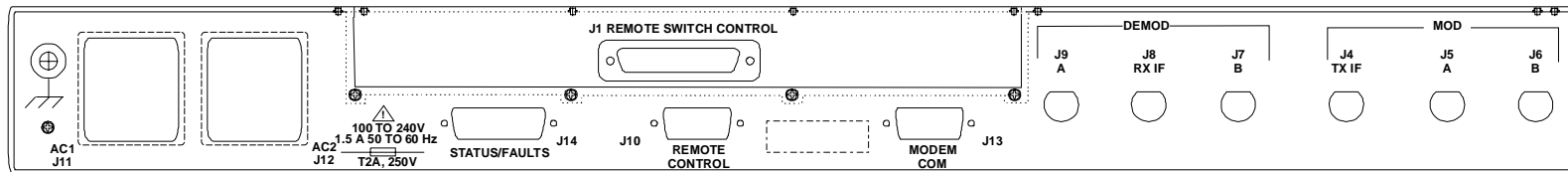
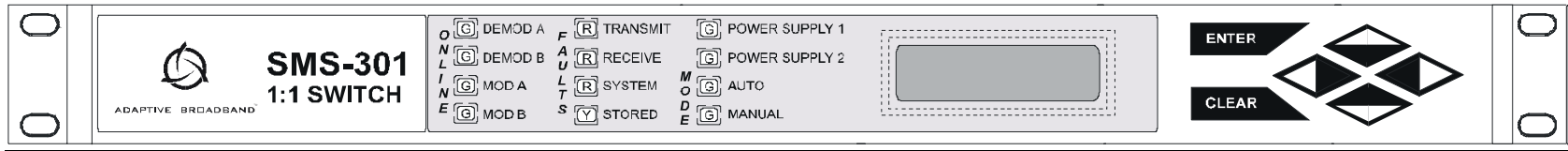

Physical:

1 RU

Size: 1.75H x 19W x 15D inches (4.4 x 48 x 39 cm)

Weight: < 9 lbs (<4 kg)

This page is intentionally left blank.

3. Typical Rack Installation

General

This section provides information to assemble a typical MIDAS System rack. Each rack shall use an addition manual to record all the vital information relating to that rack installation.

Additional information can be obtained via the Comtech EF Data Network Customer Support department.

Required Equipment

The following equipment shall be available for the rack installation. This equipment may be obtained from Comtech EF Data, Sales and Marketing department.

Equipment	Part No.	Manufacture or Description
Adapter : User Port EFBUS to CDM/CiM	CN/AD-UP-EFA CA/WR9440	Comtech EF Data User Port Adapter Comtech EF Data EFBUS1 Adapter (Used on CDM and CiM Modems)
Cables: EFBUS1/2 Ribbon with Termination EFBUS1/2 Ribbon without Termination EFBUS1/2 Y-Cable	PL/0755 PL/4167 CA/CA-ESA-EF	Comtech EF Data Comtech EF Data Comtech EF Data
Combiner	Various . ICS-50-X . ICS-75-X	Comtech EF Data Contact CEFD Sates department for correct (-x) dash number for customer's requirement.
Security Key (Dongle)	PL/9506	Comtech EF Data

Typical Rack Installation



The MIDAS System will not accept the Comtech EF Data SDM-300A with Mux, Flex Mux, or the 100-pin J8 I/O connector installed.

Workstation

The user shall construct a workstation to their specification, using the equipment recommended by Comtech EF Data. Figure 3-1 illustrates a basic workstation.

Note: Refer to *MIDAS Software Installation Guide*.

Connect supplied Y-Cable as follows:

1. Connect the supplied-cable base connector to the FASTCOM card.
 2. Connect supplied-cable Port 1 connector to the Comtech EF Data supplied EIA-422 cable from SNM-1001 Modem.
 3. Cable Port 2 connector is not connected.
 4. Connect 9-pin EIA-232 cable from Controller Server COM 1 port to SNM-1001 M&C port.
 5. Connect 9-pin EIA-232 cable from Controller Server COM 2 port to SNM-1002 M&C port.
 6. Connect 25-pin pre-programmed dongle to Controller Server 25-pin I/O port.
-

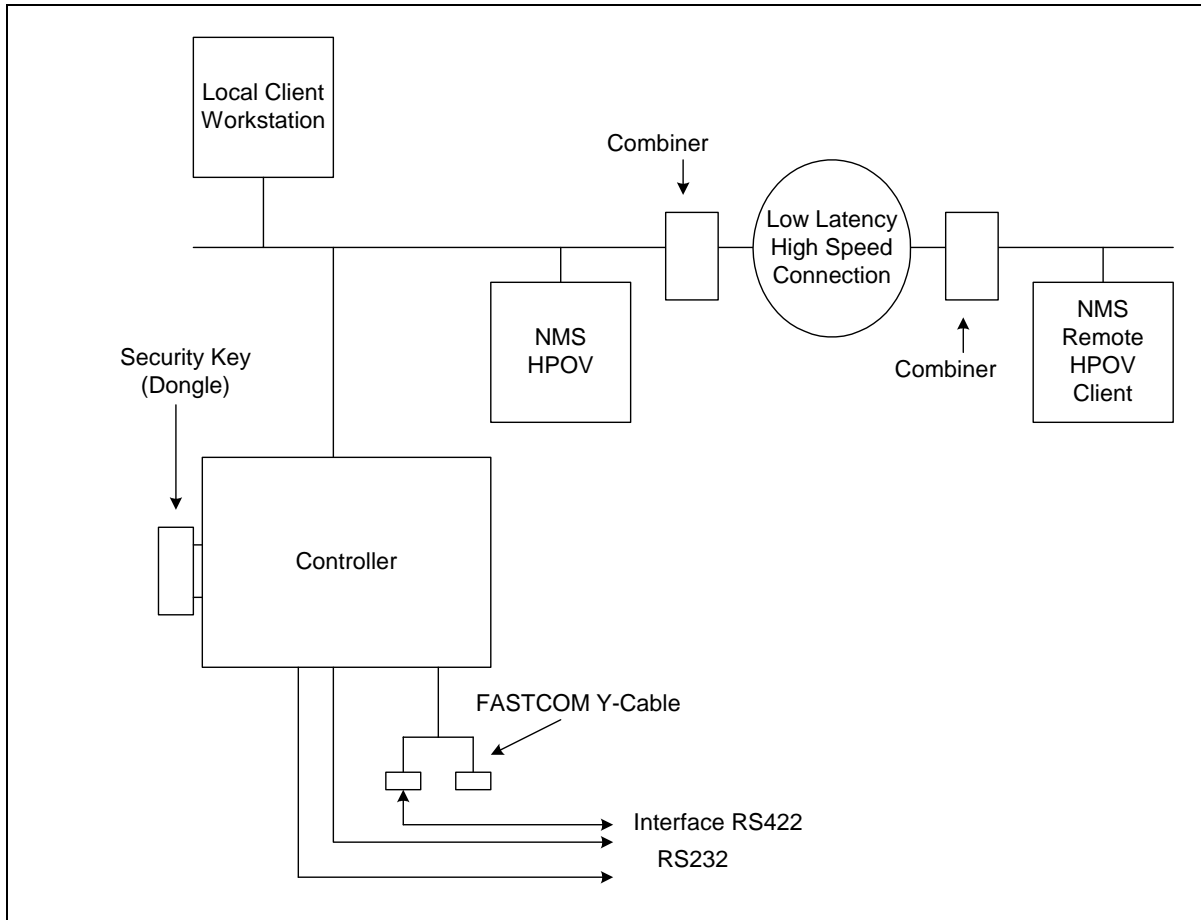
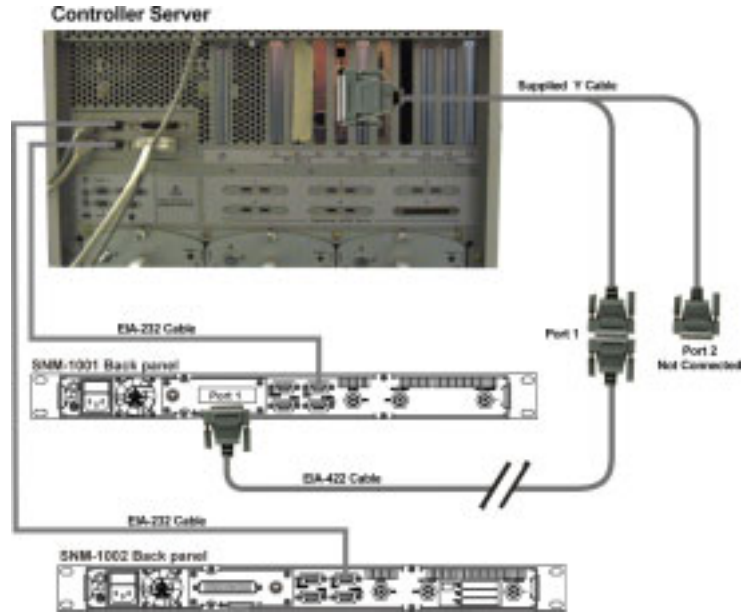

Figure 3-1. FASTCOM Y-Cable Connection (Reference Only)

Rack Installation

Located in Chapter 1 is the Equipment Rack form, each rack will have a form completed to maintain continuity of the installation. Use this form to build the rack, as follows.

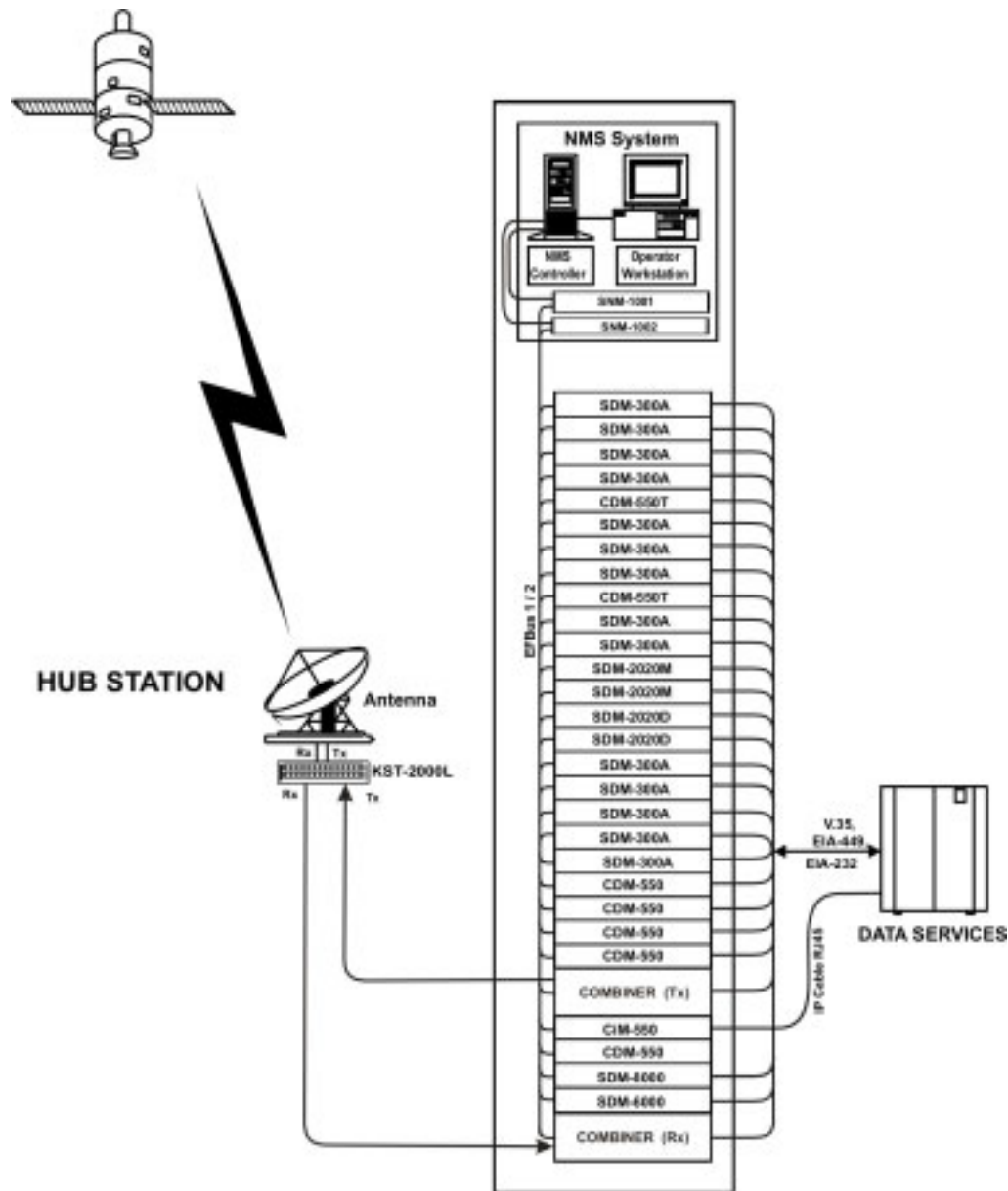

Figure 3-2. Typical Rack Installation (30-Channel)

Rack Location	Equipment Rack Number 1 Elevation	Comments
RU 44	SNM-1000	
RU 43	SNM-1001	
RU 42	SNM-1002	
RU 41	SDM-300A	Channel # 1
RU 40	SDM-300A	Channel # 2
RU 39	SDM-300A	Channel # 3
RU 38	SDM-300A	Channel # 4
RU 37	CDM-550T	Channel # 5 [Data only]
RU 36	SDM-300A	Channel # 6
RU 35	SDM-300A	Channel # 7
RU 34	SDM-300A	Channel # 8
RU 33	CDM-550T	Channel # 9 [Reserved]
RU 32	SDM-300A	Channel # 10
RU 31	SDM-300A	Channel # 11
RU 30	SDM-2020 MOD	Channel # 12 (TX only)
RU 29	SDM-2020 MOD	Channel # 13 (TX Only)
RU 28	SDM-2020 DEMOD	Channel # 14 (RX Only)
RU 27	SDM-2020 DEMOD	Channel # 15 (RX Only)
RU 26	SDM-300A	Channel # 16
RU 25	SDM-300A	Channel # 17
RU 24	SDM-300A	Channel # 18
RU 23	SDM-300A	Channel # 19
RU 22	SDM-300A	Channel 20 [Video Conference]
RU 21	CDM-550	Channel 21
RU 20	CDM-550	Channel 22
RU 19	CDM-550	Channel 23
RU 18	CDM-550	Channel 24
RU 17	Combiner	TX Only
RU 16		
RU 15	CiM-550	Channel 25
RU 14	CDM-550	Channel 26
RU 13	SDM-8000	Channel 27
RU 12	SDM-6000	Channel 28
RU 11		
RU 10	Combiner	RX Only
RU 9		
RU 8		
RU 7		
RU 6		
RU 5	Controller	
RU 4		
RU 3		
RU 2		
RU 1		

Figure 3-3. Sample Completed Equipment Rack Form

Wiring Connection

Located in Chapter 1 is the Wiring Diagram form, each rack will have a form completed to maintain continuity of the installation. Record all wiring connections and secure form with the equipment rack.

Observe the additional information needed to complete the wiring connections, as follows:

-
1. Connect Adapter P/N CA/WR9440 as appropriate :
 - a. Connect Adapter P/N CA/WR9440 to all Comtech EF Data CDM modems installed in the equipment rack, at the REMOTE CONTROL port.
 - b. Connect Adapter P/N CA/WR9440 to all Comtech EF Data CiM modems installed in the equipment rack, at the IP REMOTE port.
 2. Connect EFBUS 1/2 Y-Cable Part No. CA/CA-ESA-EF to SNM-1000 EFBUS 1/2 connector J6. Connect a ribbon-cable serial cable to all EFBUS 1/2 connectors (J6).
 3. Connect BNC Cables to TX-IF (CP1) BNC connectors to all units. Connect to the Combiner.
 4. Connect BNC Cables to RX-IF (CP2) BNC connectors to all units. Connect to the combiner.
 5. Connect Data connectors (J8) of all units in the equipment rack, in series to a combiner.
 6. Connect combiner to the KST-2000L Satellite Terminal equipment.
-

Equipment Rack History

Located on the cover of this manual is the Title Box, fill in the required information for each equipment rack, as shown in the following sample:

Title Box:

- **Station Type:** ABCDE_____
- **Station Location:** Phoenix, Arizona_____
- **Equipment Rack's Configuration Revision:** AA_____
- **Data of Last Revision:** July 4, 2001_____
- **Project Title:** Nelson_____
- **End User:** FGHIJK_____

This page is intentionally left blank.

METRIC CONVERSIONS

Units of Length

Unit	Centimeter	Inch	Foot	Yard	Mile	Meter	Kilometer	Millimeter
1 centimeter	—	0.3937	0.03281	0.01094	6.214×10^{-6}	0.01	—	—
1 inch	2.540	—	0.08333	0.2778	1.578×10^{-5}	0.254	—	25.4
1 foot	30.480	12.0	—	0.3333	1.893×10^{-4}	0.3048	—	—
1 yard	91.44	36.0	3.0	—	5.679×10^{-4}	0.9144	—	—
1 meter	100.0	39.37	3.281	1.094	6.214×10^{-4}	—	—	—
1 mile	1.609×10^5	6.336×10^4	5.280×10^3	1.760×10^3	—	1.609×10^3	1.609	—
1 mm	—	0.03937	—	—	—	—	—	—
1 kilometer	—	—	—	—	0.621	—	—	—

Temperature Conversions

Unit	° Fahrenheit	° Centigrade
32° Fahrenheit	—	0 (water freezes)
212° Fahrenheit	—	100 (water boils)
-459.6° Fahrenheit	—	273.1 (absolute 0)

Formulas
$C = (F - 32) * 0.555$
$F = (C * 1.8) + 32$

Units of Weight

Unit	Gram	Ounce Avoirdupois	Ounce Troy	Pound Avoir.	Pound Troy	Kilogram
1 gram	—	0.03527	0.03215	0.002205	0.002679	0.001
1 oz. avoir.	28.35	—	0.9115	0.0625	0.07595	0.02835
1 oz. troy	31.10	1.097	—	0.06857	0.08333	0.03110
1 lb. avoir.	453.6	16.0	14.58	—	1.215	0.4536
1 lb. Troy	373.2	13.17	12.0	0.8229	—	0.3732
1 kilogram	1.0×10^3	35.27	32.15	2.205	2.679	—



2114 WEST 7TH STREET TEMPE ARIZONA 85281 USA
480 • 333 • 2200 PHONE
480 • 333 • 2161 FAX