



UB-530

Breakout Panel
Installation and Operation Manual



UB-530

Breakout Panel Installation and Operation Manual

Comtech EF Data is an ISO 9001
Registered Company.



Part No. MN/UB530.IOM
Revision 2
June 2, 2004

Customer Support

Contact the Comtech EF Data Customer Support Department for:

- Product support or training
- Information on upgrading or returning a product
- Reporting comments or suggestions concerning manuals

A Customer Support representative may be reached at:

Comtech EF Data
Attention: Customer Support Department
2114 West 7th Street
Tempe, Arizona 85281 USA

480.333.2200 (Main Comtech EF Data Number)
480.333.4357 (Customer Support Desk)
480.333.2161 FAX

or, E-Mail can be sent to the Customer Support Department at:

service@comtechefdata.com

Contact us via the web at www.comtechefdata.com.

1. To return a Comtech EF Data product (in-warranty and out-of-warranty) for repair or replacement:
2. Request a Return Material Authorization (RMA) number from the Comtech EF Data Customer Support Department.
3. Be prepared to supply the Customer Support representative with the model number, serial number, and a description of the problem.
4. To ensure that the product is not damaged during shipping, pack the product in its original shipping carton/packaging.
5. Ship the product back to Comtech EF Data. (Shipping charges should be prepaid.)

For more information regarding the warranty policies, see Warranty Policy, p. viii.

Table of Contents

| | |
|---|------------|
| Chapter 1. Introduction | 1-1 |
| Chapter 2. Connectors and Switches | 2-1 |
| 2.1 Switches | 2-2 |
| 2.2 Connectors..... | 2-2 |

Figures

| | |
|--|-----|
| Figure 1-1. UB-530 Breakout Panel..... | 1-1 |
| Figure 2-1. UB-530 Front and Rear View..... | 2-1 |
| Figure 2-2. UB-530 to UB-300 Adapter for 25-Pin V.35 Connector (J3)..... | 2-9 |

Tables

| | |
|--|-------|
| Table 2-1. UB-530 Configuration Switch Selections..... | 2-2 |
| Table 2-2. UB-530 Breakout Panel Connectors | 2-2 |
| Table 2-3. Adapter Pinout for UB-530 to UB-300 Connection..... | 2-130 |

About this Manual

This manual provides installation and operation information for the Comtech EF Data UB-530 Breakout Panel. This a technical document intended for earth station engineers, technicians, and operators responsible for the operation and maintenance of the breakout panel.

Conventions and References

Cautions, Warnings, and Important Notes



CAUTION indicates a hazardous situation that, if not avoided, may result in minor or moderate injury. CAUTION may also be used to indicate other unsafe practices or risks of property damage.



WARNING indicates a potentially hazardous situation that, if not avoided, could result in death or serious injury.



Indicates information critical for proper equipment function.

Metric Conversion

Metric conversion information is located on the inside back cover of this manual. This information is provided to assist the operator in cross-referencing English to Metric conversions.

Trademarks

Windows™ is a trademark of the Microsoft Corporation.

Other product names mentioned in this manual may be trademarks or registered trademarks of their respective companies and are hereby acknowledged.

Reporting Comments or Suggestions Concerning this Manual

Comments and suggestions regarding the content and design of this manual will be appreciated. To submit comments, please contact the Comtech EF Data Technical Publication Department: techpub@comtechefdata.com

Overview of Changes to Previous Edition

Changes made to Revision 1 include:

| | |
|-----------|--|
| General | Changed EIA- to RS- designators. Removed references to AC/DC power. |
| Chapter 1 | Added reference to Standard 37-pin for RS-422 connector. |
| Chapter 2 | Revised pin tables. |

Electrical Safety

The UB-530 Breakout Panel does not require electrical power nor does it incorporate any fuses.

Environmental

The breakout panel must not be operated in an environment where the unit is exposed to extremes of temperature outside the ambient range 0 to 50°C (32° to 122°F), precipitation, condensation, or humid atmospheres above 95% RH, altitudes (un-pressurised) greater than 2000 metres, excessive dust or vibration, flammable gases, corrosive or explosive atmospheres.





Operation in vehicles or other transportable installations that are equipped to provide a stable environment is permitted. If such vehicles do not provide a stable environment, safety of the equipment to EN60950 may not be guaranteed.

Installation

Installation:

The installation and connection to the line supply must be made in compliance to local or national wiring codes and regulations.

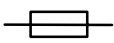
International Symbols:

| Symbol | Definition | | Symbol | Definition |
|---|---------------------|--|---|------------------|
|  | Alternating Current | |  | Protective Earth |
|  | Fuse | |  | Chassis Ground |

Telecommunications Terminal Equipment Directive

In accordance with the Telecommunications Terminal Equipment Directive 91/263/EEC, this equipment should not be directly connected to the Public Telecommunications Network.

EMC (Electromagnetic Compatibility)

In accordance with European Directive 89/336/EEC, the breakout panel has been shown, by independent testing, to comply with the following standards:

Emissions: EN 55022 Class B - Limits and methods of measurement of radio interference characteristics of Information Technology Equipment.

(Also tested to FCC Part 15 Class B)

Immunity: EN 50082 Part 1 - Generic immunity standard, Part 1: Domestic, commercial and light industrial environment.

Additionally, the breakout panel has been shown to comply with the following standards:

| | |
|---------------|--|
| EN 61000-3-2 | Harmonic Currents Emission |
| EN 61000-3-3 | Voltage Fluctuations and Flicker |
| EN 61000-4-2 | ESD Immunity |
| EN 61000-4-4 | EFT Burst Immunity |
| EN 61000-4-5 | Surge Immunity |
| EN 61000-4-6 | RF Conducted Immunity |
| EN 61000-4-8 | Power frequency Magnetic Field Immunity |
| EN 61000-4-9 | Pulse Magnetic Field Immunity |
| EN 61000-4-11 | Voltage Dips, Interruptions, and Variations Immunity |
| EN 61000-4-13 | Immunity to Harmonics |



In order that the breakout panel continues to comply with these standards, observe the following instructions:

- Connections to the transmit and receive IF ports (Type N or Type F connectors) should be made using a good quality coaxial cable - for example 50 Ω or 75 Ω .
- All 'D' type connectors attached to the rear panel must have back-shells that provide continuous metallic shielding. Cable with a continuous outer shield (either foil or braid, or both) must be used, and the shield must be bonded to the backshell.
- The equipment must be operated with its cover on at all times. If it becomes necessary to remove the cover, the user should ensure that the cover is correctly re-fitted before normal operation commences.

Safety Compliance

EN 60950



This equipment meets the Safety of Information Technology Equipment specification as defined in EN60950.



Low Voltage Directive (LVD)

The following information is applicable for the European Low Voltage Directive (EN60950):

| | |
|---|---|
| <HAR> | Type of power cord required for use in the European Community. |
|  | CAUTION: Double-pole/Neutral Fusing. ACHTUNG: Zweipolige bzw. Neutralleiter-Sicherung. |

International Symbols:

| Symbol | Definition |
|---|-----------------------------|
|  | Alternating Current. |
|  | Fuse. |

| Symbol | Definition |
|--|--------------------------|
|  | Protective Earth. |
|  | Chassis Ground. |

Note: For additional symbols, refer to “Cautions” listed earlier in this preface. Applicable testing is routinely performed as a condition of manufacturing on all units to ensure compliance with safety requirements of EN60950.

Warranty Policy

This Comtech EF Data product is warranted against defects in material and workmanship for a period of 12 months from the date of shipment. During the warranty period, Comtech EF Data will, at its option, repair or replace products that prove to be defective.

For equipment under warranty, the customer is responsible for freight to Comtech EF Data and all related custom, taxes, tariffs, insurance, etc. Comtech EF Data is responsible for the freight charges **only** for return of the equipment from the factory to the customer. Comtech EF Data will return the equipment by the same method (i.e., Air, Express, Surface) as the equipment was sent to Comtech EF Data.

Limitations of Warranty

The foregoing warranty shall not apply to defects resulting from improper installation or maintenance, abuse, unauthorized modification, or operation outside of environmental specifications for the product, or, for damages that occur due to improper repackaging of equipment for return to Comtech EF Data.

No other warranty is expressed or implied. Comtech EF Data specifically disclaims the implied warranties of merchantability and fitness for particular purpose.

Exclusive Remedies

The remedies provided herein are the buyer's sole and exclusive remedies. Comtech EF Data shall not be liable for any direct, indirect, special, incidental, or consequential damages, whether based on contract, tort, or any other legal theory.

Disclaimer

Comtech EF Data has reviewed this manual thoroughly in order that it will be an easy-to-use guide to your equipment. All statements, technical information, and recommendations in this manual and in any guides or related documents are believed reliable, but the accuracy and completeness thereof are not guaranteed or warranted, and they are not intended to be, nor should they be understood to be, representations or warranties concerning the products described. Further, Comtech EF Data reserves the right to make changes in the specifications of the products described in this manual at any time without notice and without obligation to notify any person of such changes.

If you have any questions regarding your equipment or the information in this manual, please contact the Comtech EF Data Customer Support Department.

Chapter 1. Introduction

The UB-530 (Figure 1-1) provides industry standard interface connectors for access to the modem's data, clock, control, and alarm signals via a 50-pin D-sub connector. It functions as a universal breakout panel for IDR, IBS, or D&I operations all in one, rack-mountable unit.

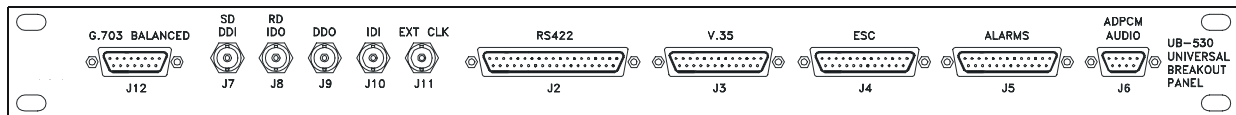

Figure 1-1. UB-530 Breakout Panel

This breakout panel can be used in 1:1 switching configurations.

Major UB-530 features include:

- Convenient access to the SDM-308 Rev. 4 ESC through a standard 25-pin D connector.
- Access to the 1/15 IBS overhead order wire, alarms, T1/E1, RS-422/449, and V.35 data interfaces. The T1/E1 can be configured for balanced or unbalanced DATA I/O signals through rear panel switches.
- Standardized interfaces for D&I data. Both balanced and unbalanced interfaces for drop DATA I/O and insert DATA I/O are provided, and are selectable through rear panel DIP switches.
- Standard 25-pin D connector pinout for V.35 or RS-530 signals
- Standard 37-pin D connector for RS-422 signals (RS-449 compatible).

The UB-530 is a standard one unit (1U) rack-mountable chassis. The unit consists of a printed circuit board, connectors, and switches for breakout panel operation. The connectors and switches are located at the front and rear panels.

The UB-530 consists of the following assemblies:

| Assembly | Part # |
|-----------------------|---------------|
| Chassis | PL/5809 |
| Printed Circuit Board | PL/5808 |

The electrical specifications for the UB-530 meet or exceed the electrical requirements of the interfacing modem.

Refer to Chapter 2 for connector and switch information.

Chapter 2. Connectors and Switches

Connections between the breakout panel and other equipment are made through front and rear panel connectors. Refer to Figure 2-1 for an illustration of the UB-530.

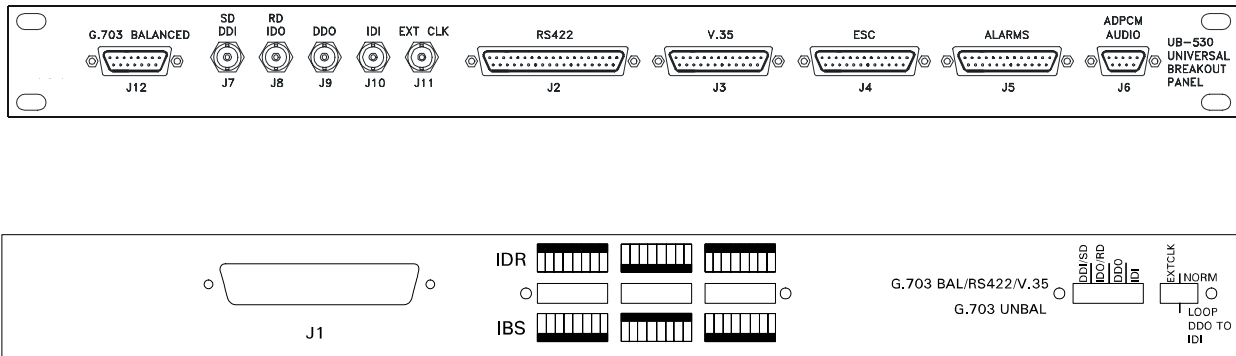

Figure 2-1. UB-530 Front and Rear Views

2.1 Switches

The five configuration DIP switches located on the rear of the breakout panel are used for selecting IBS/IDR modes of operation, and balanced or unbalanced signals, and control of D&I looping.

The RS-422 multi-functional connector (J2) on the front panel may be used for standard (non-overhead), IBS, or IDR (ESC) mode. SW1, SW2, and SW3 are used in selecting IBS or IDR mode of operation.

SW4 and SW5 are used to select balanced or unbalanced inputs and outputs.

Refer to Table 2-1 for UB-530 configuration switch settings. The locations of the switches are shown in Figure 2-1.

Table 2-1. UB-530 Configuration Switch Selections

| Switch | ON (Down) Position | OFF (Up) Position |
|---------|-------------------------|---------------------------|
| SW1-All | IBS | IDR |
| SW2-All | IDR | IBS |
| SW3-All | IBS | IDR |
| SW4-All | Unbalanced Data & Clock | Balanced Data & Clock |
| SW5-1 | Unbalanced EXT Clock | Balanced EXT Clock |
| SW5-2 | Unbalanced EXT Clock | Balanced EXT Clock |
| SW5-3 | Drop out/Insert in loop | Drop out/Insert in normal |
| SW5-4 | Drop out/Insert in loop | Drop out/Insert in normal |

2.2 Connectors

The locations of the connectors are shown in Figure 2-1. Refer to Table 2-2 for a list of UB-530 connectors.

Table 2-2. UB-530 Breakout Panel Connectors

| Ref. Desig. | Type | Interface Function |
|-------------|-----------------|----------------------------------|
| J1 | 50-pin D socket | Modem DATA I/O |
| J2 | 37-pin D socket | RS-422 or 8 kbps ESC (IDR) |
| J3 | 25-pin D socket | V.35 or RS-530 |
| J4 | 25-pin D socket | ESC |
| J5 | 25-pin D socket | Alarms (IBS and IDR) |
| J6 | 9-pin D socket | ADPCM Audio |
| J7 | BNC | Unbalanced Drop Data Input/SD |
| J8 | BNC | Unbalanced Insert Data Output/RD |
| J9 | BNC | Unbalanced Drop Data Output |
| J10 | BNC | Unbalanced Inset Data Input |
| J11 | BNC | Unbalanced External Clock |
| J12 | 15-pin D socket | Balanced G.703 |

2.2.1 Modem Data I/O (J1)

The modem data I/O connection is a 50-pin D connector located at the rear of the breakout panel. Screw locks are provided for mechanical security of the mating connector.

This connector is used to interface all signals to and from the modem. The type of signal will depend on the configuration of the modem and panel. The UB-530 supports the following configuration types and interface signals:

- IBS
- IDR
- D&I
- G.703
- V.35
- RS-422
- RS-232
- ASYNC
- Flex MUX

2.2.1.1 IBS Interface (J1)

| Signal Function | Name | Pin # |
|-------------------------|--------------|-------|
| Ground | GND | 1, 2 |
| External clock | EXC-A | 35 |
| | EXC-B | 19 |
| Serial clock TX | SCT/ST-A | 21 |
| | SCT/ST-B | 22 |
| ESC terrestrial TX data | ESC TXD-A | 5 |
| | ESC TXD-B | 4 |
| Send data | SD-A | 37 |
| | SD-B | 38 |
| T1E1 send data | T1E1 SD-A | 34 |
| | T1E1 SD-B | 18 |
| ESC terrestrial RX data | ESC RXD-A | 7 |
| | ESC RXD-B | 6 |
| Receive data | RD-A | 39 |
| | RD-B | 40 |
| T1E1 receive data | T1E1 RD-A | 36 |
| | T1E1 RD-B | 20 |
| Serial clock RX | SCR/RT-A | 23 |
| | SCR/RT-B | 24 |
| RS-422 RX octet | RS422 RXO-A | 8 |
| | RS422 RXO-B | 9 |
| Data set ready | DSR/DM-A | 41 |
| | DSR/DM-B | 48 |
| Primary alarm | PRI-C | 10 |
| | PRI-NO | 43 |
| | PRI-NC | 27 |
| Secondary alarm | SEC-C | 11 |
| | SEC-NO | 44 |
| | SEC-NC | 28 |
| Serial clock RX | SCTE/TT-A | 12 |
| | SCTE/TT-B | 13 |
| Request to send | RTS-A | 45 |
| | RTS-B | 29 |
| RX line signal detect | RLSD/RR-A | 46 |
| Receiver ready | RR-B | 30 |
| RS-422 TX octet | RS-422 TXO-A | 14 |
| | RS-422 TXO-B | 15 |
| Clear to send | CTS-A | 47 |
| | CTS-B | 31 |
| Data mode | DM-B | 32 |

2.2.1.2 IDR Interface (J1)

| Signal Function | Name | Pin # |
|----------------------------|----------|-------|
| Ground | GND | 1, 2 |
| TX octet output | 8K TXO-A | 4 |
| | 8K TXO-B | 5 |
| TX data | 8K TXD-A | 37 |
| | 8K TXD-B | 38 |
| TX clock | 8K TXC-A | 21 |
| | 8K TXC-B | 22 |
| RX octet | 8K RXO-A | 6 |
| | 8K RXO-B | 7 |
| RX data | 8K RXD-A | 39 |
| | 8K RXD-B | 40 |
| RX clock | 8K RXC-A | 23 |
| | 8K RXC-B | 24 |
| Send data | SD-A | 34 |
| | SD-B | 18 |
| Receive data | RD-A | 36 |
| | RD-B | 20 |
| External clock | EXC-A | 35 |
| | EXC-B | 19 |
| Backward alarm 1 output | BWO1-C | 8 |
| | BWO1-NO | 41 |
| | BWO1-NC | 25 |
| Backward alarm 2 output | BWO2-C | 9 |
| | BWO2-NO | 42 |
| | BWO2-NC | 26 |
| Backward alarm 3 output | BWO3-C | 10 |
| | BWO3-NO | 43 |
| | BWO3-NC | 27 |
| Backward alarm 4 output | BWO4-C | 11 |
| | BWO4-NO | 44 |
| | BWO4-NC | 28 |
| Backward alarm input | BWI-1 | 12 |
| | BWI-2 | 13 |
| | BWI-3 | 14 |
| | BWI-4 | 15 |
| ADPCM1 audio input | A1I-A | 45 |
| | A1I-B | 29 |
| ADPCM1 audio output | A1O-A | 46 |
| | A1O-B | 30 |
| ADPCM2 audio input | A2I-A | 47 |
| | A2I-B | 31 |
| ADPCM2 audio output | A2O-A | 48 |
| | A2O-B | 32 |
| Demodulator fault | DF-COM | 16 |
| | DF-NO | 50 |
| Deferred maintenance alarm | DMA | 17 |

2.2.1.3 D&I Interface (J1)

| Signal Function | Name | Pin # |
|---------------------|-----------|-------|
| Ground | GND | 1, 2 |
| Drop data input | DDI-A | 34 |
| | DDI-B | 18 |
| External clock | EXC-A | 35 |
| | EXC-B | 19 |
| Insert data output | IDO-A | 36 |
| | IDO-B | 20 |
| Drop data output | DDO-A | 37 |
| | DDO-B | 38 |
| Insert data input | IDI-A | 39 |
| | IDI-B | 40 |
| Terrestrial TX data | TER-TXDAT | 5 |
| Terrestrial RX data | TER-RXDAT | 7 |
| Primary | PRI-COM | 10 |
| | PRI-NO | 43 |
| | PRI-NC | 27 |
| Secondary | SEC-COM | 11 |
| | SEC-NO | 44 |
| | SEC-NC | 28 |
| Data set ready | DSR | 48 |

2.2.2 RS-422 (IBS) or 8 kbps ESC (IDR) (J2)

The RS-422 or 8 kbps ESC (IDR) connection is a 37-pin D connector located at the front of the breakout panel. Screw locks are provided for mechanical security of the mating connector.

The connection will operate as either an IBS (standard RS-422) or an IDR (8-kbps ESC) I/O, depending on the configuration switch settings on the rear panel (see Section 2.1).

2.2.2.1 IBS/RS-422 (J2)

| Signal Function | Name | Pin # |
|-----------------|-------|---------------|
| Ground | GND | 1, 19, 20, 37 |
| TX octet | TXO-A | 3 |
| | TXO-B | 21 |
| Send data | SD-A | 4 |
| | SD-B | 22 |
| Send timing | ST-A | 5 |
| | ST-B | 23 |
| Receive data | RD-A | 6 |
| | RD-B | 24 |
| Request to send | RTS-A | 7 |
| | RTS-B | 25 |
| Receive timing | RT-A | 8 |
| | RT-B | 26 |
| Clear to send | CTS-A | 9 |
| | CTS-B | 27 |
| Data mode | DM-A | 11 |
| | DM-B | 29 |
| Receiver ready | RR-A | 13 |
| | RR-B | 31 |
| External clock | EXC-A | 15 |
| | EXC-B | 33 |
| RX octet | RXO-A | 16 |
| | RXO-B | 34 |
| Terminal timing | TT-A | 17 |
| | TT-B | 35 |

2.2.2.2 IDR 8-kbps ESC (J2)

| Signal Function | Name | Pin # |
|--|-----------|---------------|
| Ground | GND | 1, 19, 20, 37 |
| TX octet | TXO-A | 3 |
| | TXO-B | 21 |
| TX data | TXD-A | 4 |
| | TXD-B | 22 |
| TX clock | TXC-A | 5 |
| | TXC-B | 23 |
| RX data | RXD-A | 6 |
| | RXD-B | 24 |
| Request to send/ Clear to send (see note) | RTS-CTS-A | 7, 9 |
| | RTS-CTS-B | 25, 27 |
| RX clock | RXC-A | 8 |
| | RXC-B | 26 |
| RX octet | RXO-A | 15 |
| | RXO-B | 33 |

Note: RTS/CTS lines are looped together at the connector

2.2.3 V.35, RS-530 (J3)

The V.35 connection is a 25-pin D connector located at the front of the breakout panel. Screw locks are provided for mechanical security of the mating connector.

| Signal Function | V.35 | | RS-530 | |
|--------------------------|--------|-------|--------|-------|
| | Name | Pin # | Name | Pin # |
| Ground | GND | 1, 7 | GND | 1,7 |
| Send data | SD-A | 2 | SD-A | 2 |
| | SD-B | 14 | SD-B | 14 |
| Serial clock TX | SCT-A | 15 | ST-A | 15 |
| | SCT-B | 12 | ST-B | 12 |
| Receive data | RD-A | 3 | RD-A | 3 |
| | RD-B | 16 | RD-B | 16 |
| Request to send | RTS | 4 | RS-A | 4 |
| | | | RS-B | 19 |
| Serial clock RX | SCR-A | 17 | RT-A | 17 |
| | SCR-B | 9 | RT-B | 9 |
| Clear to send | CTS | 5 | CS-A | 5 |
| | | | CS-B | 13 |
| Data set ready | DSR | 6 | DM-A | 6 |
| | | | DM-B | 22 |
| RX line signal detect | RLSD | 8 | RLSD-A | 8 |
| | | | RLSD-B | 10 |
| External data clock | EXC-A | 20 | MC-A | 20 |
| | EXC-B | 23 | MC-B | 23 |
| Serial clock TX external | SCTE-A | 24 | TT-A | 24 |
| | SCTE-B | 11 | TT-B | 11 |
| Modulator Fault | MF | 25 | MF | 25 |
| Demodulator Fault | DF | 21 | DF | 21 |

2.2.3.1 Adapting the V.35 25-Pin D Connector on the UB-530 to the UB-300 Pinout

The connectors on the UB-530 and UB-300 Universal Breakout Panels are identically wired, except for the 25-pin D connector which, is used for the V.35 data interface. The UB-530 uses a standard RS-530 pinout, while the UB-300 pinout is non-standard. The following information describes how to adapt the UB-530 to the UB-300 pinout.

An adapter is added to the UB-530 breakout panel that converts to the UB-300 pinout. Figure 2-2 illustrates the adapter that plugs directly into J3 of the UB-530, and Table 2-3 provides the wiring information for conversion from RS-530 to the UB-300 pinout.

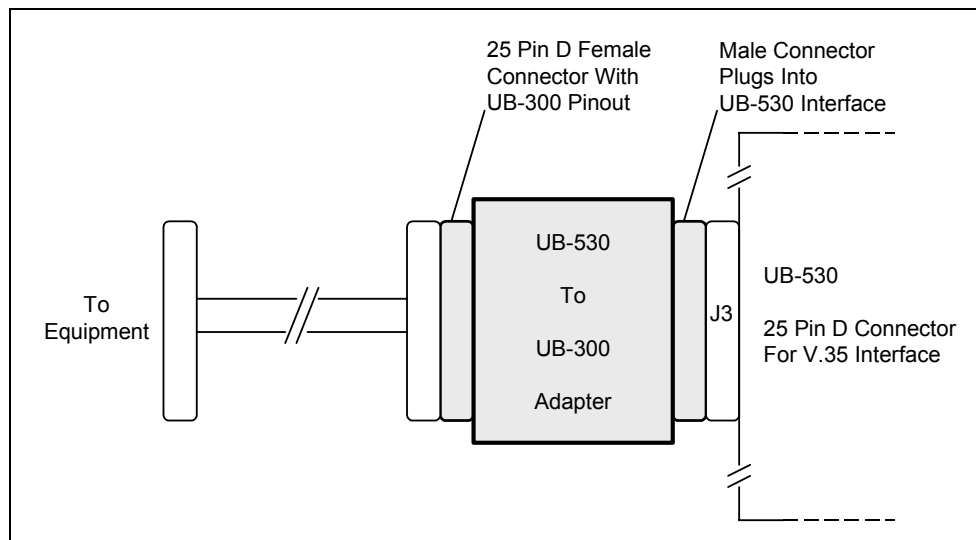

Figure 2-2. UB-530 To UB-300 Adapter For 25-Pin V.35 Connector (J3)

These adapters are available from several sources. The ones listed below are solder-less and make conversion quick and easy:

| Nomenclature | Web Site | Model/Part No. |
|--|--|----------------|
| Patton Electronics Company (tel: 301 975 1000), | (http://www.patton.com): | Model 8X-MF |
| B&B Electronics (tel: 815 433 5100), | (http://www.bb-elec.com): | 232SMFJB |

Table 2-3. Adapter Pinout For UB-530 To UB-300 Connection

| 25-Pin D Connector | | | | | |
|--------------------|---------------|----|-------|---------------|-------|
| Pin # | V.35 (RS-530) | To | Pin # | V.35 (UB-300) | Notes |
| 1 | SHLD | | 1 | SHLD | |
| 2 | SD-A | | 14 | SD-A | |
| 3 | RD-A | | 16 | RD-A | |
| 4 | RTS-A | | 4 | RTS | |
| 5 | CTS-A | | 5 | CTS | |
| 6 | DSR-A | | 6 | DSR | |
| 7 | SIGGND | | 7 | SIGGND | |
| 8 | RLSD-A | | 8 | RLSD | |
| 9 | SCR-B | | 17 | SCR-B | |
| 10 | RLSD-B | | 10 | | 1 |
| 11 | SCTE-B | | 24 | SCTE-B | |
| 12 | SCT-B | | 15 | SCT-B | |
| 13 | CTS-B | | 13 | | 1 |
| 14 | SD-B | | 2 | SD-B | |
| 15 | SCT-A | | 18 | SCT-A | |
| 16 | RD-B | | 3 | RD-B | |
| 17 | SCR-A | | 19 | SCR-A | |
| 18 | | | 11 | | |
| 19 | RTS-B | | 9 | | 1 |
| 20 | MC-A | | 22 | MC-A (EXC-A) | 2 |
| 21 | DF | | 21 | DF | 3 |
| 22 | DSR-B | | 12 | | 1 |
| 23 | MC-B | | 23 | MC-B (EXC-B) | 2 |
| 24 | SCTE-A | | 25 | SCTE-A | |
| 25 | MF | | 20 | MF | 3 |

Notes:

1. These signals are used for RS-530 (RS-422) and not required for V.35 which uses only the "A" side of the signals.
2. Use the MASTER (MC or EXC) clock for EXTERNAL clock input. This clock input should equal the data rate unless the Asymmetrical Loop Timing Option (ASLT) is available. The ASLT option allows selection of different clock rates that vary from the digital data rate. Refer to the Utility/Modem Type/Modem Options menu for the ASLT option information.
3. MF and DF are fault indication signals from the modem and are not V.35 or RS-530 standard signals.

2.2.4 Engineering Service Channel (J4)

The Engineering Service Channel (ESC) connection is a 25-pin D connector located at the front of the breakout panel. Screw locks are provided for mechanical security of the mating connector.

| Signal Function | Name | Pin # |
|---|-------------|-------|
| Ground | GND | 1, 7 |
| Transmit data | TXD-A | 2 |
| | TXD-B | 14 |
| Transmit clock | TXCLK | 15 |
| Receive data | RXD-A | 3 |
| | RXD-B | 16 |
| Request to send/ Clear to send (<i>see note</i>) | RTS/CTS | 4, 5 |
| Receive clock | RXCLK | 17 |
| Terrestrial ESC DSR | TERESESCDSR | 6 |

Note: RTS/CTS lines are looped together at the connector.

2.2.5 Alarms (J5)

The alarms connection is a 25-pin D connector located at the front of the breakout panel. The alarms interface is used to provide FORM C contact closures for the purpose of alarm reporting. FORM C contacts ratings are:

- 1A at 24 VDC
- 500 mA at 120 VAC

A connection between the Common (C) and the Normally Open (NO) contacts indicates no fault. The alarms interface will operate either in an IBS or an IDR mode, depending on the configuration switch settings on the rear panel (see Section 2.1).

2.2.5.1 IBS Alarms (J5)

| Signal Function | Name | Pin # |
|-----------------|--------|-------|
| Ground | GND | 14 |
| Primary alarm | PRI-C | 5 |
| | PRI-NO | 18 |
| | PRI-NC | 6 |
| Secondary alarm | SEC-C | 19 |
| | SEC-NO | 7 |
| | SEC-NC | 20 |

2.2.5.2 IDR Alarms (J5)

| Signal Function | Name | Pin # |
|----------------------------|---------|-------|
| Ground | GND | 14 |
| Backward alarm 1 output | BWO1-C | 2 |
| | BWO1-NO | 15 |
| | BWO1-NC | 3 |
| Backward alarm 2 output | BWO2-C | 16 |
| | BWO2-NO | 4 |
| | BWO2-NC | 17 |
| Backward alarm 3 output | BWO3-C | 5 |
| | BWO3-NO | 18 |
| | BWO3-NC | 6 |
| Backward alarm 4 output | BWO4-C | 19 |
| | BWO4-NO | 7 |
| | BWO4-NC | 20 |
| Demodulator fault | DF-COM | 8 |
| | DF-NO | 21 |
| Deferred maintenance alarm | DMA | 9 |
| Backward alarm 1 input | BWI-1 | 22 |
| Backward alarm 2 input | BWI-2 | 10 |
| Backward alarm 3 input | BWI-3 | 23 |
| Backward alarm 4 input | BWI-4 | 11 |

2.2.6 ADPCM Audio (J6)

The ADPCM audio connection is a 9-pin D connector located at the front of the breakout panel. Screw locks are provided for mechanical security of the mating connector.

| Audio Signal Function | Name | Pin # | 64k Data (RS422) |
|-----------------------|-------|-------|------------------|
| Ground | GND | 3 | Ground |
| ADPCM1 audio input | A1I-A | 1 | SDA (IN) |
| | A1I-B | 6 | SDB (IN) |
| ADPCM1 audio output | A1O-A | 2 | RTA (OUT) |
| | A1O-B | 7 | RTB (OUT) |
| ADPCM2 audio input | A2I-A | 8 | STA (OUT) |
| | A2I-B | 4 | STB (OUT) |
| ADPCM2 audio output | A2O-A | 9 | RDA (OUT) |
| | A2O-B | 5 | RDB (OUT) |

2.2.7 Drop Data Input/Send Data (J7)

The connection for the unbalanced drop data input/send data interface is a BNC connector located at the front of the breakout panel. For unbalanced operation, the configuration switches on the rear of the panel must be set correctly (see Section 2.1).

2.2.8 Insert Data Output/Receive Data (J8)

The connection for the unbalanced insert data output/receive data interface is a BNC connector located at the front of the breakout panel. For unbalanced operation, the configuration switches on the rear of the panel must be set correctly (see Section 2.1).

2.2.9 Drop Data Output (J9)

The connection for the unbalanced drop data output interface is a BNC connector located at the front of the breakout panel. For unbalanced operation, the configuration switches on the rear of the panel must be set correctly (see Section 2.1).

2.2.10 Insert Data Input (J10)

The connection for the unbalanced insert data input interface is a BNC connector located at the front of the breakout panel. For unbalanced operation, the configuration switches on the rear of the panel must be set correctly (see Section 2.1).

2.2.10 External Clock (J11)

The connection for the unbalanced external clock interface is a BNC connector located at the front of the breakout panel. This connection is used for clocking data out of the buffer. For unbalanced operation, the configuration switches on the rear of the panel must be set correctly (see Section 2.1).

2.2.11 Balanced G.703 Interface (J12)

The connection for the balanced G.703 interface is a 15-pin socket D connector located at the front of the breakout panel. Screw locks are provided for the mechanical security of the mating connector. For balanced operation, the configuration switches on the rear of the panel must be set correctly (see Section 2.1).

| Signal Function | Name | Pin # |
|-----------------------|-------|-------|
| Ground | GND | 2, 4 |
| Drop data input/SD | DDI-A | 1 |
| | DDI-B | 9 |
| Insert data output/RD | IDO-A | 3 |
| | IDO-B | 11 |
| Drop data output | DDO-A | 12 |
| | DDO-B | 5 |
| Insert data input | IDI-A | 13 |
| | IDI-B | 6 |
| External clock | EXC-A | 7 |
| | EXC-B | 8 |

METRIC CONVERSIONS

Units of Length

| Unit | Centimeter | Inch | Foot | Yard | Mile | Meter | Kilometer | Millimeter |
|--------------|---------------------|---------------------|---------------------|---------------------|------------------------|---------------------|-----------|------------|
| 1 centimeter | — | 0.3937 | 0.03281 | 0.01094 | 6.214×10^{-6} | 0.01 | — | — |
| 1 inch | 2.540 | — | 0.08333 | 0.2778 | 1.578×10^{-5} | 0.254 | — | 25.4 |
| 1 foot | 30.480 | 12.0 | — | 0.3333 | 1.893×10^{-4} | 0.3048 | — | — |
| 1 yard | 91.44 | 36.0 | 3.0 | — | 5.679×10^{-4} | 0.9144 | — | — |
| 1 meter | 100.0 | 39.37 | 3.281 | 1.094 | 6.214×10^{-4} | — | — | — |
| 1 mile | 1.609×10^5 | 6.336×10^4 | 5.280×10^3 | 1.760×10^3 | — | 1.609×10^3 | 1.609 | — |
| 1 mm | — | 0.03937 | — | — | — | — | — | — |
| 1 kilometer | — | — | — | — | 0.621 | — | — | — |

Temperature Conversions

| Unit | ° Fahrenheit | ° Centigrade |
|--------------------|--------------|-----------------------|
| 32° Fahrenheit | — | 0 (water freezes) |
| 212° Fahrenheit | — | 100 (water boils) |
| -459.6° Fahrenheit | — | 273.1 (absolute 0) |

| Formulas |
|------------------------|
| $C = (F - 32) * 0.555$ |
| $F = (C * 1.8) + 32$ |

Units of Weight

| Unit | Gram | Ounce Avoirdupois | Ounce Troy | Pound Avoir. | Pound Troy | Kilogram |
|--------------|-------------------|-------------------|------------|--------------|------------|----------|
| 1 gram | — | 0.03527 | 0.03215 | 0.002205 | 0.002679 | 0.001 |
| 1 oz. avoir. | 28.35 | — | 0.9115 | 0.0625 | 0.07595 | 0.02835 |
| 1 oz. troy | 31.10 | 1.097 | — | 0.06857 | 0.08333 | 0.03110 |
| 1 lb. avoir. | 453.6 | 16.0 | 14.58 | — | 1.215 | 0.4536 |
| 1 lb. Troy | 373.2 | 13.17 | 12.0 | 0.8229 | — | 0.3732 |
| 1 kilogram | 1.0×10^3 | 35.27 | 32.15 | 2.205 | 2.679 | — |



2114 WEST 7TH STREET TEMPE ARIZONA 85281 USA
480 • 333 • 2200 PHONE
480 • 333 • 2161 FAX